

Georgia Milestones

Assessment System



Study/Resource Guide for Students and Parents Grade 8



The Study/Resource Guides are intended to serve as a resource for parents and students. They contain practice questions and learning activities for each content area. The standards identified in the Study/Resource Guides address a sampling of the state-mandated content standards.

For the purposes of day-to-day classroom instruction, teachers should consult the wide array of resources that can be found at www.georgiastandards.org.

Study/Resource Guide

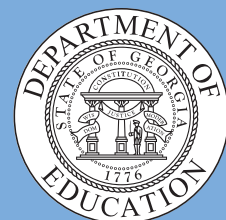

Table of Contents

THE GEORGIA MILESTONES ASSESSMENT SYSTEM	3
HOW TO USE THIS GUIDE	4
PREPARING FOR TAKING TESTS	5
OVERVIEW OF THE END-OF-GRADE ASSESSMENT	6
TYPES OF ITEMS	6
DEPTH OF KNOWLEDGE	8
ENGLISH LANGUAGE ARTS (ELA)	11
DESCRIPTION OF TEST FORMAT AND ORGANIZATION	11
CONTENT	11
ITEM TYPES	11
ENGLISH LANGUAGE ARTS (ELA) DEPTH OF KNOWLEDGE EXAMPLE ITEMS	12
ENGLISH LANGUAGE ARTS (ELA) CONTENT DESCRIPTION AND ADDITIONAL SAMPLE ITEMS	22
ENGLISH LANGUAGE ARTS (ELA) ADDITIONAL SAMPLE ITEM KEYS	54
ENGLISH LANGUAGE ARTS (ELA) SAMPLE SCORING RUBRICS AND EXEMPLAR RESPONSES	57
ENGLISH LANGUAGE ARTS (ELA) WRITING RUBRICS	63
MATHEMATICS	72
DESCRIPTION OF TEST FORMAT AND ORGANIZATION	72
CONTENT	72
ITEM TYPES	72
MATHEMATICS DEPTH OF KNOWLEDGE EXAMPLE ITEMS	73
MATHEMATICS CONTENT DESCRIPTION AND ADDITIONAL SAMPLE ITEMS	80
MATHEMATICS ADDITIONAL SAMPLE ITEM KEYS	111
MATHEMATICS SAMPLE SCORING RUBRICS AND EXEMPLAR RESPONSES	114
SCIENCE	124
DESCRIPTION OF TEST FORMAT AND ORGANIZATION	124
CONTENT	124
ITEM TYPES	124
SCIENCE DEPTH OF KNOWLEDGE EXAMPLE ITEMS	125
SCIENCE CONTENT DESCRIPTION AND ADDITIONAL SAMPLE ITEMS	129
SCIENCE ADDITIONAL SAMPLE ITEM KEYS	165
SOCIAL STUDIES	172
DESCRIPTION OF TEST FORMAT AND ORGANIZATION	172
CONTENT	172
ITEM TYPES	172
SOCIAL STUDIES DEPTH-OF-KNOWLEDGE EXAMPLE ITEMS	173
SOCIAL STUDIES CONTENT DESCRIPTION AND ADDITIONAL SAMPLE ITEMS	176
SOCIAL STUDIES ADDITIONAL SAMPLE ITEM KEYS	212
APPENDIX A: LANGUAGE PROGRESSIVE SKILLS, BY GRADE	219
APPENDIX B: CONDITION CODES	220

THE GEORGIA MILESTONES ASSESSMENT SYSTEM



Dear Student,

This Georgia Milestones Grade 8 Study/Resource Guide for Students and Parents is intended as a resource for parents and students. It contains sample questions and helpful activities to give you an idea of what test questions look like on Georgia Milestones and what the Grade 8 End-of-Grade (EOG) assessment covers.

These sample questions are fully explained and will tell you why each answer is either correct or incorrect.

Get ready—open this guide—and get started!

HOW TO USE THIS GUIDE

Let's get started!

* **Get it together!**

- This guide
- Pen or pencil
- Highlighter
- Paper

* **Gather materials**

- Classroom notebooks
- Textbooks

* **Study space**

- Find a comfortable place to sit.
- Use good lighting.
- Time to focus—no TV, games, or phones!

* **Study time**

- Set aside some time after school.
- Set a goal—how long are you going to study?
- Remember—you cannot do this all at one time.
- Study a little at a time every day.

* **Study buddy**

- Work with a friend, sister, brother, parent—anyone who can help!
- Ask questions—it is better to ask now and get answers.
- Make sure you know what you need to do—read the directions before you start.
- Ask your teacher if you need help.

* **Test-taking help**

- Read each question and all of the answer choices carefully.
- Be neat—use scratch paper.
- Check your work!



PREPARING FOR TAKING TESTS

Getting ready!



Here are some ideas to think about before you take a test.

- Get plenty of rest and eat right. Take care of your body and your mind will do the rest.
- If you are worried about a test, don't be. Talk with a teacher, parent, or friend about what is expected of you.
- Review the things you have learned all year long. Feel good about it.
- Remember that a test is just one look at what you know. Your class work, projects, and other tests will also show your teachers how much you have learned throughout the year.

Try your best!

OVERVIEW OF THE END-OF-GRADE ASSESSMENT

What is on the End-of-Grade Assessment?

- * English Language Arts (ELA)
- * Mathematics
- * Science
- * Social Studies

TYPES OF ITEMS

- * **Selected-response items**—also called multiple-choice
 - English Language Arts (ELA), Mathematics, Science, and Social Studies
 - There is a question, problem, or statement that is followed by four answer choices.
 - There is only ONE right answer, so read EACH answer choice carefully.
 - Start by eliminating the answers that you know are wrong.
 - Then look for the answer that is the BEST choice.
- * **Technology-enhanced items**—also called multiple-select or two-part questions
 - English Language Arts (ELA), Mathematics, Science, and Social Studies
 - There is a question, problem, or statement.
 - You may be asked to select more than one right answer.
 - You may be asked to answer the first part of the question. Then, you will answer the second part of the question based on how you answered part one.
 - Read the directions for each question carefully.
 - Start by eliminating the answers you know are wrong.
 - If the question has two parts, answer the first part before you move to the second part.
- * **Constructed-response items**
 - English Language Arts (ELA) and Mathematics only
 - There is a question, problem, or statement but no answer choices.
 - You have to write your answer or work out a problem.
 - Read the question carefully and think about what you are asked to do.
 - In English Language Arts (ELA), go back to the passage to look for details and information.
 - You will be scored on accuracy and how well you support your answer with evidence.
- * **Extended constructed-response items**
 - English Language Arts (ELA) and Mathematics only
 - These are similar to the constructed-response items.
 - Sometimes they have more than one part, or they require a longer answer.
 - Check that you have answered all parts of the question.

* **Extended writing prompt**

- English Language Arts (ELA) only
- There is a question, problem, or statement.
- You may be asked to do more than one thing.
- In English Language Arts (ELA), you will be asked to read two passages and then write an essay.
- You will be scored on how well you answer the question and the quality of your writing.
- Organize your ideas clearly.
- Use correct grammar, punctuation, and spelling.
- Support your answer with evidence from the text.

DEPTH OF KNOWLEDGE

Test questions are designed with a Depth of Knowledge (DOK) level in mind. As you go from Level 1 to Level 4, the questions get more and more challenging. They take more thinking and reasoning to answer. You may have experienced these types of questions in your classroom as your teachers find ways to challenge you each day.

A Level 1 item may not require as much thinking as a Level 4 item—but that does not mean it’s easy.

A Level 4 item may have more than one part or ask you to write something.

Here is some information to help you understand just what a DOK level really is.

Level 1 (Recall of Information)

- * Identify, list, or define something.
- * Questions may start with *who*, *what*, *when*, and *where*.
- * Recall facts, terms, or identify information.

Level 2 (Basic Reasoning)

- * Think about things—it is more than just remembering something.
- * Describe or explain something.
- * Answer the questions “how” or “why.”

Level 3 (Complex Reasoning)

- * Go beyond explaining or describing “how and why.”
- * Explain or justify your answers.
- * Give reasons and evidence for your response.
- * Make connections and explain a concept or a “big idea.”

Level 4 (Extended Reasoning)

- * Complex thinking required!
- * Plan, investigate, or apply a deeper understanding.
- * These items will take more time to write.
- * Connect and relate ideas.
- * Show evidence by doing a task, creating a product, or writing a response.

Depth of Knowledge

Level 1—Recall of Information

Level 1 asks you to identify, list, or define. You may be asked to recall *who*, *what*, *when*, and *where*. You may also be asked to recall facts and terms or identify information in documents, quotations, maps, charts, tables, graphs, or illustrations. Items that ask you to “describe” and/or “explain” could be Level 1 or Level 2. A Level 1 item requires that you just recall, recite, or repeat information.

Skills Demonstrated	Question Cues
<ul style="list-style-type: none"> • Make observations • Recall information • Recognize formulas, properties, patterns, processes • Know vocabulary, definitions • Know basic concepts • Perform one-step processes • Translate from one representation to another • Identify relationships 	<ul style="list-style-type: none"> • Tell who, what, when, or where • Find • List • Define • Identify; label; name • Choose; select • Compute; estimate • Express as • Read from data displays • Order

Level 2—Basic Reasoning

Level 2 includes some thinking that goes beyond recalling or repeating a response. A Level 2 “describe” and/or “explain” item would require that you go beyond a description or explanation of information to describe and/or explain a result or “how” or “why.”

Skills Demonstrated	Question Cues
<ul style="list-style-type: none"> • Apply learned information to abstract and real-life situations • Use methods, concepts, and theories in abstract and real-life situations • Perform multi-step processes • Solve problems using required skills or knowledge (requires more than habitual response) • Make a decision about how to proceed • Identify and organize components of a whole • Extend patterns • Identify/describe cause and effect • Recognize unstated assumptions; make inferences • Interpret facts • Compare or contrast simple concepts/ideas 	<ul style="list-style-type: none"> • Apply • Calculate; solve • Complete • Describe • Explain how; demonstrate • Construct data displays • Construct; draw • Analyze • Extend • Connect • Classify • Arrange • Compare; contrast

Level 3—Complex Reasoning

Level 3 requires reasoning, using evidence, and thinking on a higher level than Level 1 and Level 2. You will go beyond explaining or describing “how and why” to justifying the “how and why” through reasons and evidence. Level 3 items often involve making connections across time and place to explain a concept or a “big idea.”

Skills Demonstrated	Question Cues
<ul style="list-style-type: none"> • Solve an open-ended problem with more than one correct answer • Create a pattern • Generalize from given facts • Relate knowledge from several sources • Draw conclusions • Make predictions • Translate knowledge into new contexts • Compare and discriminate between ideas • Assess value of methods, concepts, theories, processes, and formulas • Make choices based on a reasoned argument • Verify the value of evidence, information, numbers, and data 	<ul style="list-style-type: none"> • Plan; prepare • Predict • Create; design • Ask “what if?” questions • Generalize • Justify; explain why; support; convince • Assess • Rank; grade • Test; judge • Recommend • Select • Conclude

Level 4—Extended Reasoning

Level 4 requires the complex reasoning of Level 3 with the addition of planning, investigating, applying deeper understanding, and/or developing that will require a longer period of time. You may be asked to connect and relate ideas and concepts *within* the content area or *among* content areas in order to be at this highest level. The Level 4 items would be a show of evidence—through a task, a product, or an extended response—that the higher level demands have been met.

Skills Demonstrated	Question Cues
<ul style="list-style-type: none"> • Analyze and synthesize information from multiple sources • Examine and explain alternative perspectives across a variety of sources • Describe and illustrate how common themes are found across texts from different cultures • Apply mathematical models to illuminate a problem or situation • Design a mathematical model to inform and solve a practical or abstract situation • Combine and synthesize ideas into new concepts 	<ul style="list-style-type: none"> • Design • Connect • Synthesize • Apply concepts • Critique • Analyze • Create • Prove

ENGLISH LANGUAGE ARTS (ELA)

DESCRIPTION OF TEST FORMAT AND ORGANIZATION

The Grade 8 English Language Arts (ELA) EOG assessment has a total of 60 items.

You will answer a variety of item types on the test. Some of the items are selected-response(multiple-choice), which means you choose the correct answer from four choices. Some items will ask you to write your response using details from the text. There will also be a writing prompt that will ask you to write an essay.

The test will be given in three sections.

- Section 1 will be given on Day 1. You will be given a maximum of 90 minutes to complete the section.*
- Sections 2 and 3 will be given over one or two days. You may have up to 75 minutes to complete each section.

CONTENT

The Grade 8 English Language Arts (ELA) EOG assessment will measure the Grade 8 standards that are described at www.georgiastandards.org.

The content of the assessment covers standards that are reported under these domains:

- Reading and Vocabulary
- Writing and Language

There are two kinds of texts—fiction (including stories and poems) and informational text.

There are two kinds of essays—an argumentative essay and an informational/explanatory essay.

Students will also write extended constructed responses that use narrative techniques such as completing a story, writing a new beginning, or adding dialogue. (Item 5 on page 27 gives an example of a prompt that requires a narrative response.)

ITEM TYPES

The English Language Arts (ELA) portion of the Grade 8 EOG assessment consists of selected-response (multiple-choice), technology-enhanced (multiple-select or two-part questions), constructed-response, extended constructed-response, and extended writing-response items.

* Beginning with the Spring 2017 administration, the extended writing-response will appear in Section 1. Prior to Spring 2017, the extended writing-response appears in Section 3.

ENGLISH LANGUAGE ARTS (ELA) DEPTH OF KNOWLEDGE EXAMPLE ITEMS

Example items that represent applicable DOK levels are provided for you on the following pages. The items and explanations of what is expected of you to answer them will help you prepare for the test.

All example and sample items contained in this guide are the property of the Georgia Department of Education.

Example Item 1

Selected-Response

DOK Level 1: This is a DOK level 1 item because it requires students to recognize an infinitive and how it functions in the sentence.

English Language Arts (ELA) Grade 8 Content Domain II: Writing and Language

Standard: ELAGSE8L1a. Demonstrate command of the conventions of standard English grammar and usage when writing or speaking.

- a. Explain the function of verbals (gerunds, participles, infinitives) in general and their function in particular sentences.

How does the underlined phrase function in the sentence?

Because field trips are educational, the class wanted to visit the museum.

- A. verb
- B. subject
- C. direct object
- D. predicate nominative

Correct Answer: C

Explanation of Correct Answer: The correct answer is choice (C) direct object. The words *to visit* are an infinitive, which functions as a noun. In this sentence, they are the direct object of the verb *wanted*. Choice (A) is incorrect because *wanted* is the verb in this sentence, though *visit* can function as a verb in other sentences. Choice (B) is incorrect because *class* is the subject of the sentence. Choice (D) is incorrect because the sentence does not contain a verb of *being*.

To answer Example Items 2 through 4, you will read two passages about Houdini. What roles do both natural talent and hard work play in achieving a goal? You will answer two questions and then write an informational essay about having a goal and the steps you need to take to realize that goal.

Before you begin planning and writing, read these two passages:

1. Show Me Impossible
2. Houdini

As you read the passages, think about what details from the passages you might use in your informational essay.

Read these two passages about Houdini and answer Example Items 2 through 4.

Show Me Impossible

It was barely 5 A.M. when Daniel left his two-room apartment on the Lower East Side of New York City and headed uptown. He had read yesterday's newspaper with excitement. Stories about Houdini had been plastered on the front pages of the papers for weeks—ever since his last show when he was handcuffed, then nailed inside a packing crate, and subsequently thrown into the river. Harry Houdini, the most sensational escape artist of all time, not only survived the incident, but swam to the surface in record time, where he was greeted by a crowd of cheering fans.

Daniel knew he had to see him, and the escape artist's next show was near enough for Daniel to attend. So Daniel got on the train especially early in the morning to make sure he was there before anyone else. He had heard about the crowds that came to Houdini's performances. He was not only determined to be there himself, but he was going to secure a seat in the first row.

"This man," Daniel had read earlier that week in the paper, "is a marvel. Either he has superhuman strength and skill, or he's an exceptionally clever illusionist. Either way, he's the most daring performer the world has ever seen." *Illusionist*—the word grabbed him. He whispered it quietly, forming the syllables with his lips. Then he said it out loud. "Illusionist." He loved the way it rolled off his tongue.

It certainly was not a word that was familiar in Daniel's world. In 1924, you were expected to remain grounded in reality, the polar opposite of illusion. Daniel thought about his former schoolteacher, Mrs. Thorpe, and the lessons she taught stressing that everything was explainable by science. Once he had chosen a fantasy novel from the library to read just for fun, but Mrs. Thorpe discouraged it. "I prefer that you choose a sensible book," she said. "That book is nothing more than nonsense."

She most likely would assert that Houdini was nothing but nonsense, too, Daniel thought. Houdini made the impossible happen—an illusionist can do that. An illusionist allows people to see the impossible—or what they presume to be impossible. Houdini was making believers out of the millions who saw him perform, believers in the impossible.

Daniel had looked up the word in a dictionary. "Illusionist." Houdini created illusions—he was a master at tricks of the eye. This man had been sealed inside a giant football and the carcass of a giant squid. He had been strapped in a straightjacket and hung by his ankles from the tops of tall buildings. The dictionary defined illusionist as "a person who performs tricks that deceive the eye." Mrs. Thorpe had used that term, "deceive the eye," in a science lesson. Daniel just knew that he had to see Houdini so that this daring illusionist could make him a believer, too.

Houdini

In 1928, a man and an elephant stood in the center of the Hippodrome Theater’s stage in the heart of New York City. As a spotlight beamed down upon them, the man raised his arm high in the air, a popping sound was heard, and in a flash, Jennie, the 10,000-pound elephant, suddenly disappeared. All that was left standing on the stage was the man alone. The elephant had vanished into thin air. And the man standing on the stage was Harry Houdini.

Houdini was born Erik Weisz in Budapest, Hungary. Upon immigrating to the United States, he first took up residence in Appleton, Wisconsin. He later became a circus entertainer performing trapeze acts. However, when the circus traveled to New York City, he knew it to be the right place for a performer.

He had a smattering of success in vaudeville, but eventually found his way into escape performances. It seemed that he had a great talent for picking locks, and that led to other feats—escapes from trunks, straightjackets, and even coffins. The phrase “They do it with mirrors” was applied to Houdini many times. Disbelievers felt that he was little more than an illusionist, a trickster. They accused him of deceit, stating that he cheated with trap doors or only appeared to be nailed in a box or locked in chains.

However, the unglamorous truth was that Houdini was a superb physical being with some enormous talents. For instance, he could hold his breath for an extraordinary amount of time. Additionally, he was strong and determined. When being tied up or bound in a straightjacket, he would fill his lungs to capacity and flex his muscles. That way he could gain a few millimeters of free space which would enable his forthcoming escape. He was not afraid to dislocate joints, such as a shoulder, or even rip flesh pulling an arm or a hand free of bindings. He might conceal a piece of metal under his tongue and use it to pick a lock. But free himself he would, and he did it without mirrors or any other kind of magic.

Despite the accusations of deception, Houdini remained popular with the American public. He continued to dream up more and more dangerous stunts, and people flocked to see them. No matter what people believed about him, he always escaped in the most straightforward way. He unlocked the locks, he got free of the chains, he made a tiny space in a lid into a bigger space. He used talent, strength, and resourcefulness, without any trickery.

Example Item 2

Selected-Response

DOK Level 2: This is a DOK level 2 item because the meaning of the word is based on the context of the passage.

English Language Arts (ELA) Grade 8 Content Domain I: Reading and Vocabulary

Genre: Literary

Standard: ELAGSE8RL4. Determine the meaning of words and phrases as they are used in a text, including figurative and connotative meanings; analyze the impact of specific word choices on meaning and tone, including analogies or allusions to other texts.

Read these sentences from “Show Me Impossible.”

Illusionist—the word grabbed him. He whispered it quietly, forming the syllables with his lips. Then he said it out loud. “*Illusionist*.” He loved the way it rolled off his tongue.

Which definition of the word grabbed BEST conveys the meaning the word has in the first sentence?

- A. captured
- B. caught
- C. fascinated
- D. seized

Correct Answer: C

Explanation of Correct Answer: The correct answer is choice (C) fascinated. The paragraph makes clear that Daniel is enchanted, or fascinated, by the word. Choices (A), (B), and (D) are incorrect because they do not convey the meaning the author intended. Choice (A) is close in meaning but does not match the intensity of how the word makes Daniel feel. Choices (B) and (D) are incorrect because, while they are valid definitions, they do not explain the connotation of the word as the author is using it in this sentence.

Example Item 3

Constructed-Response

DOK Level 3: This is a DOK level 3 item because students are asked to infer meaning from the text and analyze the paragraph’s importance to the passage as a whole.

English Language Arts (ELA) Grade 8 Content Domain I: Reading and Vocabulary

Genre: Informational

Standard: ELAGSE8RI5. Analyze in detail the structure of a specific paragraph in a text, including the role of particular sentences in developing and refining a key concept.

Explain how paragraph 4 of “Houdini” contributes to the reader’s understanding of the passage.

Support your response with details from the passage. Write your answer on the lines provided.

A large rectangular box containing 20 horizontal lines for writing a response.

Scoring Rubric

Points	Description
2	<p>The exemplar shows a full-credit response. It achieves the following:</p> <ul style="list-style-type: none"> • Gives sufficient evidence of the ability to explain how a paragraph in a text helps to develop and refine a key concept within the text • Includes specific examples/details that make clear reference to the text • Adequately explains the development of concepts based on the text
1	<p>The exemplar shows a 1-point response. It achieves the following:</p> <ul style="list-style-type: none"> • Gives limited evidence of the ability to explain how a paragraph in a text develops and refines a key concept within the text • Includes vague/limited examples/details that make reference to the text • Explains the development of concepts based on the text
0	<p>The exemplar shows a response that would earn no credit. It achieves the following:</p> <ul style="list-style-type: none"> • Gives no evidence of the ability to explain how a paragraph in a text develops and refines a key concept within the text

Exemplar Response

Points Awarded	Sample Response
2	<p>Paragraph 4 explains Houdini the man and the idea that he was able to perform these tricks because he was strong and clever. He knew what he was doing and had ways to escape that were planned out in advance and did not rely on magic or illusions. They were real feats of strength. This paragraph is important because it takes away the mystery surrounding Houdini. Houdini would fill his lungs with air or hide a metal pick under his tongue. This proves that he was not really performing magic—he had figured out ways to escape from the most difficult physical situations.</p>
1	<p>Paragraph 4 explains that Houdini had figured out how to escape and make it seem like magic or illusions. You learn about this when you read this paragraph. For example he could hold his breath for a long period of time. He was really not a magician. He knew what to do.</p>
0	<p>Paragraph 4 talks about Houdini. He was strong.</p>

Example Item 4

Extended Constructed-Response

DOK Level 4: This is a DOK level 4 item because it requires analyzing and synthesizing information from different sources. Students must combine ideas from the two passages and write an essay that builds on what was read and explains something new.

English Language Arts (ELA) Grade 8 Content Domain II: Writing and Language

Genres: Literary and Informational

Standard: ELAGSE8W2. Write informative/explanatory texts to examine a topic and convey ideas, concepts, and information through the selection, organization, and analysis of relevant content.

Now that you have read “Show Me Impossible” and “Houdini,” create a plan for and write your informational essay.

WRITING TASK

Many people have goals such as Houdini did. Think about ideas, facts, definitions, details, and other information and examples you want to use. Think about how you will introduce your topic and what the main topic will be for each paragraph. Be sure to identify the sources by title or number when using details or facts directly from the sources.

Write an **informational essay** about having a goal and the steps needed to realize that goal.

Be sure to use information from BOTH passages. **Write your answer on the lines provided.**

Be sure to:

- Introduce the topic clearly, provide a focus, and organize information in a way that makes sense.
- Use information from the two passages so that your essay includes important details.
- Develop the topic with facts, definitions, details, quotations, or other information and examples related to the topic.
- Identify the passages by title or number when using details or facts directly from the passages.
- Develop your ideas clearly and use your own words, except when quoting directly from the passages.
- Use appropriate and varied transitions to connect ideas and to clarify the relationships among ideas and concepts.
- Use clear language and vocabulary.
- Establish and maintain a formal style.
- Provide a conclusion that supports the information presented.
- Check your work for correct usage, grammar, spelling, capitalization, and punctuation.

The following is an example of a seven-point response. See the seven-point, two-trait rubric for a text-based informational/explanatory response on pages 66 and 67 to see why this example would earn the maximum number of points.

Example of a Seven-Point Response:

It is important to have goals and to work toward achieving them. Some people may be lucky and have a natural talent for doing something. But others have to work hard and plan or train to achieve their goal.

Houdini had a goal of being an escape artist and capturing the imagination of his audiences with his feats. He had natural skills that he practiced and perfected. In the second passage, we see that Houdini's ability to perform illusions and escapes were based in great part on his physical skills. For example, it was his unusual strength, in addition to practice, that enabled him to escape a straightjacket. His strength and physique allowed him to enlarge his chest cavity and his muscles sufficiently in order to have a bit of free space later, when it was time to free himself. Perfecting this escape, though, must have taken a great deal of training and practice.

Other people who dream of achieving Houdini-like feats, however, like Daniel in the first passage, might have to work a lot harder. There is no mention of Daniel having the natural abilities that Houdini had, and it is not likely that many people would have that natural talent. People like Daniel would have to train longer and harder in order to learn how to become an illusionist.

Any dream or goal requires a combination of natural ability and hard work. If you have a dream or goal, you should first see what talents you may have to help that dream come true. Then you should work hard and train to make it happen. It is probably more important to have some natural talents to develop, but training should help as well. Both are an important part of reaching your goal.

ENGLISH LANGUAGE ARTS (ELA) CONTENT DESCRIPTION AND ADDITIONAL SAMPLE ITEMS

In this section, you will find information about what to study in order to prepare for the Grade 8 English Language Arts EOG assessment. This includes key terms and important vocabulary words. This section also contains practice questions, with an explanation of the correct answers, and activities that you can do on your own, with your classmates, or with your family to prepare for the test.

All example and sample items contained in this guide are the property of the Georgia Department of Education.

Unit 1: Reading Literary Text

READING PASSAGES: LITERARY TEXT

CONTENT DESCRIPTION

The literary passages in the English Language Arts (ELA) test are used to identify main ideas and details, cite evidence, make inferences, determine themes, and understand vocabulary.

Key Ideas and Details

- Ideas and details tell you what the story or poem is about.
- Use these ideas and details when writing or speaking about the story or poem.
- Look for central ideas or themes as you read. Ask yourself—what is this about?
- Think about the characters, setting, and events in the story.
- Summarize the important details and ideas after you read.

Structure of the Text

- Make sure you understand the words and phrases as you read.
- Think about how specific words can help you understand the meaning or tone.
- Look at the structure of stories. Pay attention to how the parts of the text (e.g., a section, chapter, scene, or stanza) work with each other and the story or poem as a whole.
- Think about the point of view or purpose of a text.

Understanding What You Read

- Think about the story and visualize, or make a mental picture, as you read.
- Think about the message or what the writer is trying to say.

KEY TERMS

Inference: To infer means to come to a reasonable conclusion based on evidence found in the text. By contrast, an **explicit** idea or message is fully stated or revealed by the writer. The author tells the reader exactly what they need to know. (RL1)

Theme: The theme of a literary text is its lesson or message. For example, a story could be about two friends who like to do things together, and the theme might be the importance of friendship. (RL2)

Plot: The series of events that form a story in a specific order. (RL3)

Resolution: In most stories there is a conflict or problem. The resolution is the solution to the problem or the end of the main dramatic conflict. (RL3)

Allusion: An indirect reference to something. When a writer refers to something without mentioning it explicitly, it is an allusion. For example, *He didn't want to give gifts to anyone at Christmas; he was being a scrooge.* In this sentence, the writer is alluding to Ebenezer Scrooge from Charles Dickens' *A Christmas Carol*. (RL.4)

Figurative language: To understand figurative language, you need to distinguish between literal and figurative meanings of words and phrases. Literal refers to the actual meaning of a word or phrase. For example, if someone tells you to open the door, you can open a physical door. If someone tells you to "open the door to your heart," you are opening up your feelings and emotions.

Personification: When a writer describes an object as if it were a person. For example, *The trees sighed in the afternoon breeze.* The trees cannot really sigh but seemed to as they blew gently in the breeze. (L5a)

Simile: A comparison using *like* or *as*. For example, *She is as pretty as a picture.* (L5a)

Metaphor: A direct comparison that states one thing *is* another. It isn't meant to be literal, but descriptive. For example, *He is an animal on the soccer field* does not mean that the boy is really an animal, but it is a metaphor for how he plays soccer (very aggressively). (RL.4)

Examples of figurative language are similes and metaphors. **Similes** make a comparison using a linking word such as *like*, *as*, or *than* (her eyes shone like the stars). A **metaphor** makes a comparison without a linking word; instead of being *like* another, one thing *is* another (her eyes *were* shining stars). (RL4)

Alliteration: The use of the same sound to start several words in a row. For example, *The beautiful butterfly blew by the bay.* Literary devices such as alliteration can have a big impact on poems, stories, and dramas. (RL4)

Point of view: The perspective from which a story is told. The point of view depends upon who the narrator is and how much he or she knows. The point of view could be first person (*I* went to the store), second person (*You* went to the store), or third person (*He* went to the store). (RL6)

Compare vs. contrast: Though similar, comparing is analyzing two things such as characters or stories in relation to each other, while contrasting is specifically analyzing the *differences* between two things, such as two different characters or stories.(RL7/RL9)

Genre: A **genre** is a category of passages, such as fiction and nonfiction. Each genre has a particular style, form, and content. (RL9)

Important Tips

- ✍ Use supporting ideas and concepts to answer *what* you know and *how* you know it.
- ✍ Try to answer the question before you read the answer choices.
- ✍ Try to read the questions about a literary text before you read.
- ✍ Re-read a literary text as you answer the questions to gain a better understanding.

Sample Items 1–5

Use this passage to answer questions 1 through 5.

Pony Express

The low morning sun stretched across the hotel dining room as a young cowboy walked toward the lone occupant. Shafts of light shone through the dust, producing golden bands not quite parallel to the floor. Holding his new Stetson hat respectfully at his side, the cowboy walked toward him. The man noted his approach, rose, and extended his hand. “Ah, Mr. Sewell, I presume. I’m Derek Bollinger.” Caleb Sewell was taken off guard at being addressed as Mister, especially by a man wearing a suit that Caleb couldn’t afford with the wages of his last month’s work.

“Yep. Howdy.” The words were out automatically, and Caleb immediately regretted his lack of formality as he shook the man’s hand and sat down. He fidgeted with his hat, not knowing where it should go, but certain that it couldn’t go back on his head. Bollinger, sensing his discomfort, pulled out one of the empty chairs and nodded to it.

“In the interest of saving valuable time, Mr. Sewell, I’ve ordered for us both.” Caleb nodded approval and restrained himself from saying something silly like, “Aw, that’s right neighborly of ya.” A waitress filled his coffee cup. To avoid embarrassment, he added only about half his usual amount of sugar. He watched the expensively dressed man for clues as to what to do with his stirring spoon, how to hold the delicate cup, and where to put his napkin.

Mercifully, two orders of steak, eggs, beans, and sourdough biscuits arrived before any more pauses set in. Eating made it easier for Caleb to avoid talking, though he continued to watch Bollinger’s actions closely. The man began enumerating Caleb’s responsibilities as a Pony Express rider. Mail, he said, was a precious commodity. It both connected and fulfilled lives on each end of the route. He must never exhaust the horses; he would ride six or seven each day, and they were the lifeline of the whole enterprise. He should report conditions on the trail—fallen trees, landslides, washed out bridges—at the nearest transfer station. He was to ride alone except when an escort with the local law was arranged. He would have protection on the Humboldt Pass section where robberies had become frequent of late.

Caleb had been briefed on most of this when he filled out an application back home in Wheeling, so the best information he took from Bollinger was that it was acceptable to sop his bean juice with a biscuit. Bollinger did all of the talking. To Caleb’s great relief, Bollinger did not ask what had brought a man out to the wilds of the frontier when he could have enjoyed the security of working in the family business as part of a comfortably successful family in the quiet state of West Virginia. He didn’t know how to explain what a burden it was to have a family that wanted to determine how the rest of your life should proceed. He had no words to explain their disappointment at his wanting to chart his own course, not to mention how effortlessly he’d settled into a life on the plains.

At length, the man stood, shook hands with Caleb a last time, and told him he was to pick up his horse and packet of mail at the livery stable. “Good to have you with us on the Pony Express, Mr. Sewell. We have begun forging a strong tradition throughout the West and the nation. Now, do us and yourself proud.” Caleb bent down, retrieved his hat from the chair, and when he stood back up, Bollinger was gone.

The handlers were ready for him at the stable. Two saddlebags straddled a bar outside a box stall that said “Pony Express Only.” In the stall, his own personal saddle was already on a small Appaloosa. The horse shifted and paced nervously, a sign that he’d been given a more than ample breakfast of oats. Caleb led the horse into the street and was tightening the cinch of the saddle when a clerk came up to him with a delivery log. Caleb signed it, secured the saddlebags, and threw his leg up over the saddle. The horse bolted for the open road, but Caleb’s deft touch convinced the horse of the pace they would maintain.

Caleb Sewell’s first day as a Pony Express rider had begun. It would end twelve hours and eighty miles later.

Item 1

Selected-Response

Which detail from the passage indicates that Caleb is self-conscious?

- A. The low morning sun stretched across the hotel dining room as a young cowboy walked toward the lone occupant.
- B. Holding his new Stetson hat respectfully at his side, the cowboy walked toward him.
- C. He fidgeted with his hat, not knowing where it should go, but certain that it couldn’t go back on his head.
- D. He was to ride alone except when an escort with the local law was arranged.

Item 2

Selected-Response

Read the sentence from the passage.

Mercifully, two orders of steak, eggs, beans, and sourdough biscuits arrived before any more pauses set in.

In what way is the arrival of food a merciful event?

- A. Caleb was in need of food because he had not been making much money.
- B. Caleb was less likely to embarrass himself while he was busy eating.
- C. The Pony Express delivered meals to those who were going hungry.
- D. The breakfast was provided free of charge to Pony Express riders.

Item 3

Selected-Response

Which detail would be **BEST** to include in a summary of the passage?

- A. A waitress filled his coffee cup.
- B. He should report conditions on the trail.
- C. At length, the man stood and shook hands with Caleb a last time.
- D. His own personal saddle was already on a small Appaloosa.

Item 4

Multi-Part Technology-Enhanced

This question has two parts. Answer Part A, and then answer Part B.

Part A

What motivates Caleb to want to become a Pony Express rider?

- A. a desire to be independent from his family
- B. a need for adventure in his life
- C. a desire to make a great deal of money
- D. a need to travel to other places

Part B

Which sentence from the passage **BEST** supports the answer in Part A?

- A. Caleb Sewell was taken off guard at being addressed as Mister, especially by a man wearing a suit that Caleb couldn't afford with the wages of his last month's work.
- B. He must never exhaust the horses; he would ride six or seven each day, and they were the lifeline of the whole enterprise.
- C. He had no words to explain their disappointment at his wanting to chart his own course, not to mention how effortlessly he'd settled into a life on the plains.
- D. The horse bolted for the open road, but Caleb's deft touch convinced the horse of the pace they would maintain.

Item 5

Extended Constructed-Response

Based on the information in the passage, write a continuation of the passage that reveals Caleb’s inner dialogue, or his thoughts, as he begins riding his first Pony Express route.

Support your response with details from the passage. Write your answer on the lines provided.

A large rectangular box containing 20 horizontal lines for writing a response.

Unit 2: Reading Informational Text

READING PASSAGES: INFORMATIONAL TEXT

CONTENT DESCRIPTION

The informational and explanatory passages in the English Language Arts test can be used to determine central ideas, write an objective summary, analyze ideas, and provide supporting text evidence.

Key Ideas and Details

- Read closely to know exactly what the text says.
- Look for details that tell what the text is about.
- Use those details when writing or speaking about the text.
- Look for the central ideas in the text.
- Summarize the important details and ideas.
- Think about how ideas develop and work together in the text.

Structure

- Make sure you understand the words in the text.
- Use a dictionary, thesaurus, or glossary to help you with words that are new.
- Look at how the parts of the text work with each other.
- Think about the author's point of view or purpose in the text.

Understanding the Text

- Think about the text as if it were presented as a movie or a television show.
- Think about the text and its message.
- Look for details or evidence in the text.

KEY TERMS

Summary: A summary is an overview of a text that captures the main points but does not give all of the details and does not include opinions. (RI2)

Interactions: How ideas influence individuals or events or how individuals influence ideas or events. As one analyzes the interactions in a text, they give insight into the meaning. (RI3)

Connotative meaning: A meaning beyond the explicit meaning of a word. For example, the word *childlike* connotes innocence as well. Connotations are meanings inferred from certain words. (RI4)

Denotative meaning: The explicit meaning of a word. For example, *helpful* has only one meaning and connotation, which is to be of service or assistance. (RI4)

Organization: The way in which a piece of writing is structured. Each sentence, paragraph, or chapter fits into the overall structure of a text and contributes to the development of ideas. (RI5)

Author’s purpose: The author’s intention for his or her piece. All passages have a purpose, whether it is to persuade, inform, explain, or entertain. (RI6)

Author’s point of view: The opinion of the author. Your opinion may differ from the opinion of the author writing a passage. (RI6)

Evidence: Something that proves or demonstrates the truth of something else. Informational texts may contain evidence to prove that the information they are providing is correct. (RI8)

Fact and opinion: A **fact** is a statement that can be proven. An **opinion** is a statement that cannot be proven because it states a writer’s belief or judgment about something. Deciding whether or not a statement is a fact or an opinion often comes down to a single question: “Can you prove it?” If you can prove a statement, then it is a fact. If not, it’s an opinion. (RI2)

Chronological order: The order in which a series of events happened. A text that is arranged in order of time from the beginning to the end is in chronological order. (RI5)

Cause and effect: This is a relationship where one thing causes another thing to happen. A passage may also be organized by stating the **problem and solution** as well. (RI3)

Important Tips

- ✍ Try to read the questions about an informational text before you read the text so that you know what to look out for.
- ✍ Use evidence from a passage to help explain what is being said.
- ✍ Use facts and details to support ideas and answer *what* you know and *how* you know it.

Sample Items 6–9

Read the following passage and answer questions 6 through 9.

Living in the Darkness under the Sea

Marine biologists patrol an undersea world that resembles a rocky landscape more than it does an ocean floor. The scientists cruise through the water in a remote-controlled submarine in complete darkness. If they shine a light, what they see is something totally unexpected: tall rock formations jutting up from the ocean floor and surrounded by black smoke, similar to underwater chimneys. Circling these rocky peaks are worm-like organisms. They resemble red-and-white tubes—like giant peppermint sticks. What is even more amazing is that these odd creatures are not only alive, but living in this dark underworld away from light and the sun’s energy. So how is that possible?

Underwater vents somehow create an environment where these striped creatures can exist. Ever since the discovery of the creatures in 1977, scientists have been both baffled and intrigued by the very existence of these strange creatures that grow out of vents on the ocean floor away from sunlight.

What scientists have learned is that there are large cracks, or vents, in the ocean floor where these creatures exist. These deep-sea vents can be compared to the kinds of geysers you see on land. But, instead of shooting up from the ground, they shoot up from the bottom of the ocean floor. According to the National Oceanographic and Atmospheric Administration (NOAA), the billowing black smoke that exists on the ocean floor is probably the result of hot liquids bursting from the vents and mixing with the extremely cold ocean water.

What is so shocking about this information? Well, scientists always believed that life on Earth could not exist without sunlight. Yet somehow energy is being released below the surface of the water, and all without the benefit of the sun. It’s as if these undersea vents have created a unique ecosystem, deriving energy from Earth itself.

Scientists even have named the underwater creatures. They are called *extremophiles*—a fancy name for organisms that live in an extreme environment in the ocean vents. Scientists continue to study extremophiles to determine just how the creatures turn these vents into sources of usable energy.

Item 6**Selected-Response**

Which detail from the passage **BEST** supports the conclusion that the deep-sea organisms described in the passage may have changed our understanding of life?

- A. tall rock formations jutting up from the ocean floor and surrounded by black smoke
- B. These odd creatures are not only alive, but living in this dark underworld away from light.
- C. large cracks, or vents, in the ocean floor where these creatures exist
- D. Energy is being released below the surface of the water.

Item 7**Selected-Response**

Which of these **BEST** expresses the meaning of *deriving* in the sentence?

It's as if these undersea vents have created a unique ecosystem, deriving energy from Earth itself.

- A. depositing
- B. emptying
- C. extracting
- D. wasting

Item 9

Constructed-Response

What is the central idea of the passage?

Support your response with details from the passage. Write your answer on the lines provided.

A large rectangular box containing 25 horizontal lines for writing a response.

Unit 3: Writing Informational/Explanatory Texts

CONTENT DESCRIPTION

The informational/explanatory passages in the English Language Arts test help develop your writing. Informational writing states ideas, summarizes research, and uses information from more than one source.

Text Types and Purposes

- Write informational/explanatory texts to state ideas and information clearly and accurately.
- Use the best details, organize them, and explain them when necessary.

Production and Distribution of Writing

- Produce writing with organization and style that fits the task, purpose, and audience.
- Develop and strengthen writing by planning, revising, editing, rewriting, or trying a new approach.
- Use technology, including the Internet, to produce and share writing.

Audience, Purpose, and Voice

- As you write, remember who your audience will be.
- Make sure your writing is appropriate. Watch your tone, style, and voice.
- Remember, you are writing for a purpose—think about *what* you are writing and *why*.

Range of Writing

- Write routinely over extended time frames (time for research, reflection, and revision) and shorter time frames (a single sitting or a day or two) for a range of tasks, purposes, and audiences.

Scoring Rubrics

- Scoring rubrics can be found beginning on page 63. You may find it helpful to read and discuss these with a parent or another adult.
- The rubrics show you what is needed to produce a strong piece of writing.
- Rubrics are important to understand. They tell you what to add to your writing.
- Writing on the EOG assessment will be scored using these rubrics.

KEY TERMS

Informational/explanatory texts: A form of writing that informs the reader or explains something. (W2d)

Introduction: The beginning of a piece of writing. The introduction should let readers know what they will be reading about and set up the main idea of the writing. (W2a)

Organization: The way in which a piece of writing is structured. Similar ideas and illustrations should be grouped together, and the order of the information should make sense. (W2a/W4)

Transition: A word, phrase, or clause that links one idea to the next. Writing should not jump from one idea to the next without transitions that guide the reader to the next idea. Examples include words such as *another*, *for example*, *also*, and *because*. (W2c)

Conclusion: The end of a piece of writing is the conclusion. The conclusion should sum up the main idea of the writing and provide an overall message for the reader. (W2f)

Formatting: The way in which a piece of writing is organized. For example, a writer can use headings and subheadings to organize the writing and present the information in a clear way. (W2a)

Multimedia: A variety of mediums. Writing does not only include pen on paper or a typed essay. Other ways of enhancing writing can include mediums such as art, presentations, photographs, charts, videos, and more. (W2a)

Writing Process: Most informational or technical pieces require hard work and revision before they can be considered ready. Even professional writers may struggle with their words. Drafting, revising, editing, and proofreading your writing are all essential parts of an effective writing process. The steps in the writing process are prewriting, drafting, revising and editing, proofreading, and publishing. (W5)

Important Tips

- ✍ Begin by organizing your ideas in different sections. You can use a graphic organizer such as a chart or Venn diagram, or you can create an outline of your writing. Then it will be easier to fill in the supporting details.
- ✍ Be sure to develop your writing with details such as facts, definitions, quotations, or other information that supports your topic.
- ✍ Organize your writing by using chronological order, cause and effect, compare and contrast, or asking and answering questions.
- ✍ Make sure your writing has a concluding statement that supports your central idea.
- ✍ Strengthen your writing by planning, revising, editing, rewriting, or trying a new approach.

Sample Items 10–13

[**NOTE:** The structure of the practice items for this unit and Unit 4 that follows is as it appears on the Georgia Milestones End-of-Grade assessment: 1) multiple-choice questions (three on the actual test); 2) a constructed-response item; and 3) an extended writing prompt. Additionally, the instructions for the extended writing prompt are in a format that is similar to the one on the End-of-Grade assessment. There is no extended writing prompt in this unit.]

In this section, you will read a passage and answer questions 10 through 13. You will read about the status of pandas in China and how their presence affects the economy and tourism of China. You will answer four questions about the passage.

Read the following passage and answer questions 10 through 13.

Panda Economics

One of the most easily recognizable faces in the animal kingdom is that of the giant panda. That large, round, white face with the big black patches around the expressive eyes consistently warms hearts around the globe. But how much do you really know about the panda and the interesting relationship that exists between pandas and their homeland?

Endangered Pandas

As you probably know, pandas are those endangered, 250-pound, black-and-white bears living in the remote mountain areas of central China. They are slow-moving animals who divide their day between eating and resting and little else. It is estimated that there are about 1,000 to 1,500 pandas still living in the wild and maybe another 100 to 200 living in zoos around the world. Pandas primarily eat bamboo shoots and excel at tree climbing. They spend at least half of their day pulling bamboo off the trees. They can eat almost thirty pounds in a day. That's quite an appetite. But pandas do more than just ingest the bamboo. Their gathering and chewing actually spreads bamboo seeds around, which in turn helps more trees to grow.

Saving the Panda through Ecotourism

What you may not know is how pandas and China help one another through *ecotourism*. Think of that term as a combination of *ecology* and *tourism*. In everyday language, it's a lot like saying, "If you vacation here, you will be helping the environment." The Chinese government has done much to protect the beloved pandas. It has built natural habitats for the pandas to live in. These are places where they can rest, chomp away on bamboo, and live in a protected environment. And all this resting and chomping attracts tourists to China. Obviously, the pandas benefit, but the money the tourists spend on their tour is money in China's pocket. People from around the world travel to China to visit and observe the pandas in these habitats. So pandas become a significant source of revenue for the country. At a time the country is spending money to protect them, the pandas, in a sense, repay their country.

Pandas also help the Chinese economy in other ways. Pandas are loaned to zoos around the world for upwards of a million dollars a year. Pandas are big business for zoos, as people flock to see them and spend money in the process. And the money that is paid for the loan of the pandas is then used to help maintain the habitats where the pandas live.

The relationship between pandas and ecotourism is a fascinating one. There's always the risk that bringing tourists to natural habitats will result in the destruction of those habitats. But for now, the pandas are at peace, dining on bamboo, and their habitats are protected, with tourism dollars providing support.

Item 10

Selected-Response

Read these sentences from paragraph 2.

They spend at least half of their day pulling bamboo off the trees. They can eat almost thirty pounds in a day. That's quite an appetite. But pandas do more than just ingest the bamboo.

Which words **BEST** replace *ingest* without changing the meaning of the sentence?

- A. grab onto
- B. almost ruin
- C. hungrily eat
- D. lightly nibble

Item 11

Selected-Response

Which sentence **BEST** explains the central idea of the passage?

- A. The panda population is declining.
- B. Pandas are endangered and need help.
- C. Ecotourism encourages travel to a foreign country.
- D. Ecotourism helps pandas and the national economy.

Item 12

Constructed-Response

The author of this passage would like to add another paragraph with the heading “The Other Side of Ecotourism.” Where should the author place the new paragraph? Explain why.

Support your response with details from the passage. Write your answer on the lines provided.

A large rectangular box containing 25 horizontal lines for writing a response.

Unit 4: Writing Argumentative Texts

CONTENT DESCRIPTION

The argumentative passages in the English Language Arts test help you develop arguments and claims and support a point of view on a topic. In your writing, use evidence, examples, quotations, and reasons to develop and support your claims and arguments.

Purpose

- An argumentative piece takes a stand or agrees or disagrees with a point of view.
- Some common words are *agree* or *disagree* or *for* or *against*.
- When you state your argument, you need to support it with claims, reasons, examples, and evidence.

Editing Your Writing

- Check your writing for good organization.
- Make sure your writing fits the task, purpose, and audience.
- Strengthen your writing by planning, revising, editing, rewriting, or trying a new approach.
- Use technology, including the Internet, to do research.

Scoring Rubrics

- Scoring rubrics can be found beginning on page 63. You may find it helpful to read and discuss these with a parent or another adult.
- The rubrics show you what is needed to produce a strong piece of writing.
- Rubrics are important to understand. They tell you what to add to your writing.
- Writing on the EOG assessment will be scored using these rubrics.

KEY TERMS

Claims: Ideas and opinions set forth by the author. For example, a writer could make the claim that the school cafeteria food is too expensive. In a well-developed argumentative essay, the writer should also recognize alternate or opposing claims. (W1a)

Evidence: The reasons given to support a writer's claims. For example, a writer could include information on the price of school lunch or the number of students who do not want to buy it as reasons to support the claim that the school cafeteria is too expensive. (W1b)

Relationships: The ways in which ideas are connected. Writing should use words, phrases, and clauses to clarify the relationships among claims and reasons. (W1c)

Purpose: The writer's intention for his or her piece. All writing has a purpose, whether it is to persuade, inform, explain, or entertain. (W4)

Audience: The people who will be reading the piece of writing. Writers should keep their audience in mind and adjust their ideas and vocabulary so that they can be best understood. (W4)

Organization: In writing, the organization helps explain ideas and information more clearly. Writers use transitions to organize information. Also, an entire piece of writing has an organizational structure to it. Writers structure their texts to match their purpose and audience. For example, if you were writing an argumentative text in which you wanted to show the negative effects of something, you might choose cause and effect as an organizational structure. (W1a)

Revision: The process of editing and rewriting a piece of writing. All good writing requires a lot of revision in order to catch mistakes and clarify ideas. (W5)

Important Tips

- ✍ Make sure that the arguments you make in your writing have clear reasons and relevant evidence. The evidence must strongly support your claims.
- ✍ Organize your writing by using chronological order, cause and effect, compare and contrast, or asking and answering questions.
- ✍ Make sure your writing has a concluding statement that supports the information or explanation presented.
- ✍ Always read over your writing several times to check your work and catch errors.

Sample Items 14–17

[**NOTE:** The structure of the practice items for this unit is as it appears on the Georgia Milestones End-of-Grade assessment: 1) multiple-choice items (three on the actual test); 2) a constructed-response item; and 3) an extended writing prompt. Additionally, the instructions for the extended writing prompt are in a format that is similar to the one on the End-of-Grade assessment.]

In this section, you will read two passages and answer questions 14 through 17.

WRITING TASK

You will read about the debate about labeling menu choices with nutritional information.

Should there be a law that requires restaurants and fast food places to post nutritional information, including calories, fat content, and sodium, on their menus? Write an **argumentative essay** supporting either side of the debate in which you argue that labeling menu choices should become law OR that it should not.

Be sure to use information from BOTH passages. **Write your answer on the lines provided.**

Before you begin planning and writing, you will read two passages and answer three questions about what you have read. As you read the passages, think about what details from the passages you might use in your argumentative essay. These are the titles of the passages you will read:

1. **Label the Meals**
2. **We Don't Need Labels**

Label the Meals

Our city has proposed that establishments selling meals—restaurants and fast-food places—post nutritional information on their menus or menu boards. For the good of our citizens, this measure must pass.

I'll start by making an obvious point, one that both sides should agree on. Healthy people are happier and more productive. One part of the healthy person equation is, of course, fitness, and that is clearly good for the individual. However, eating nutritious food is another part of that same equation. Labeling meals in restaurants is one sure way of helping people take charge of their well-being.

According to studies, the average American eats at home about two-thirds of the time. Over the last 25 years, the packaging of food to be consumed in the home has included nutritional information: calories, fat calories, sodium, calcium, and the like. It's the law to include this information on all packaging, regardless of whether the food is healthful or not. So it makes no sense to deny the consumer the same information when dining out.

Research shows that when such information is available, about one-quarter of customers use it to limit what they decide to eat. Those customers consume an average of 400 fewer calories than they typically did prior to labeling. Another study compared results in a nationwide coffee shop that also sold pastries. In some cities, the shops were required to post the calories for each item; in other cities, there was no such information. The average purchase contained about 100 fewer calories when the information was provided. The U.S. government agrees that restaurant meals should be labeled. It is part of the Affordable Care Act of 2010, which requires that standard menu items include information on nutrition.¹

Eating out is on the rise. In 1977, Americans consumed 18% of their calories away from home. Less than 30 years later, that number had risen to 33%. It nearly doubled. This trend poses increased risks for all of us, not just in terms of calories, but in terms of unhealthful ingredients such as fat and sodium. Armed with relevant information, consumers can address this risk and be better for it.

We know the octane level of the fuel we put in our cars. We should know the relevant information about the fuel we put in our bodies. Please vote for labeling.

¹www.federalregister.gov

We Don't Need Labels

The proposal to require our community's eating establishments to post nutritional information for their meals is misdirected. It will not achieve any of the benefits its supporters claim.

First, the research claiming a reduction in caloric intake is, at times, contradictory. For instance, when researchers interviewed customers, they were told that the information caused them to select a "healthier" meal. However, when the cash register records were analyzed, there was no change from the way those same customers ordered previously. People may like the idea of nutritional labeling, but they still don't seem to be acting on it. I would suggest that those who claim to be reading and following the nutritional information actually need it the least. They are already health conscious. They have a good idea which meals are laden with calories, fats, and other ingredients. The Food and Drug Administration (FDA) not only requires food be labeled, but also provides the % Daily Value so that you can track the nutrients you are consuming.²

A good number of restaurant patrons are frequently looking for something other than a healthful eating experience. They are there for convenience, for a break in the routine, or for a special occasion. For these people, labeling is irrelevant.

But for the restaurant, it is a nuisance and a potential threat to their business. It means that before a new item goes on the menu, it has to be evaluated. It means that as recipes are modified and improved, more testing is needed. This is government inserting itself into business. Food should look good and taste good.

Foods for home consumption have been labeled for decades; but according to consumer research, that information has had a minimal effect on sales. What food producers have learned is that the overall packaging makes a far greater difference. The words "Lite," "Low fat," and "Heart Smart" do attract buyers. Restaurants are free to group selections according to reasonable health standards. This would probably mean more to the average consumer than trying to sort through the difference between 1350 calories and 1375 calories. Let's face it—the tastiest foods are the ones loaded with calories.

While labeling appears to promote healthful dining, its actual impact will most likely be minimal at best and harmful at worst.

²U.S. Food and Drug Administration (www.fda.gov)

Item 14

Selected-Response

Read the paragraph from “Label the Meals.”

Research shows that when such information is available, about one-quarter of customers use it to limit what they decide to eat. Those customers consume an average of 400 fewer calories than they typically did prior to labeling. Another study compared results in a nationwide coffee shop that also sold pastries. In some cities, the shops were required to post the calories for each item; in other cities, there was no such information. The average purchase contained about 100 fewer calories when the information was provided. The U.S. government agrees that restaurant meals should be labeled. It is part of the Affordable Care Act of 2010, which requires that standard menu items include information on nutrition.

Which sentence would **BEST** support the writer’s argument when added to the paragraph?

- A. Families can choose to eat at home or go out.
- B. Coffee shops will be forced to stop selling baked goods.
- C. Customers can then decide to use or ignore the information.
- D. Restaurants will likely lose customers once the information is posted.

Item 15

Selected-Response

Read the sentences from “We Don’t Need Labels.”

It means that before a new item goes on the menu, it has to be evaluated. It means that as recipes are modified and improved, more testing is needed. This is government inserting itself into business. Food should look good and taste good.

Which sentence should be removed because it is **NOT** relevant to the argument?

- A. It means that before a new item goes on the menu, it has to be evaluated.
- B. It means that as recipes are modified and improved, more testing is needed.
- C. This is government inserting itself into business.
- D. Food should look good and taste good.

Item 16**Selected-Response**

Which revision to this sentence **BEST** maintains a formal style?

Let's face it—the tastiest foods are the ones loaded with calories.

- A. Just go for it, and tasty foods are always higher in calories.
- B. In fact, the tastiest foods may be the ones with the most calories.
- C. Seriously, those fattening foods can also really be the tastiest ones.
- D. No worries, the foods with the best taste are also the most fattening.

Item 17

Extended Writing-Response

Now that you have read “Label the Meals” and “We Don’t Need Labels” and have answered some questions about what you have read, create a plan for and write your argumentative essay.

WRITING TASK

You will read about the debate about labeling menu choices with nutritional information.

Should there be a law that requires restaurants and fast food places to post nutritional information, including calories, fat content, and sodium, on their menus? Write an **argumentative essay** supporting either side of the debate in which you argue that labeling menu choices should become law OR that it should not.

Be sure to use information from BOTH passages. **Write your answer on the lines provided.**

Be sure to:

- Introduce your claim.
- Support your claim with logical reasons and relevant evidence from the passages.
- Acknowledge and address alternate or opposing claims.
- Organize the reasons and evidence logically.
- Develop your ideas clearly and use your own words, except when quoting directly from the passages.
- Identify the passages by title or number when using details or facts directly from the passages.
- Use words, phrases, or clauses to connect ideas and to clarify the relationships among claims, counterclaims, reasons, and evidence.
- Establish and maintain a formal style.
- Use clear language and vocabulary.
- Provide a conclusion that supports the argument presented.
- Check your work for correct usage, grammar, spelling, capitalization, and punctuation.

Unit 5: Language

CONTENT DESCRIPTION

The language portion of the English Language Arts test focuses on the use of proper grammar, punctuation, spelling, and usage.

Language

- You need to express yourself clearly and in an interesting way.
- Choose your words carefully so your readers understand what you are writing.
- Apply the rules of grammar as you write.

Conventions of Standard English

- Use correct grammar and usage when writing.
- Use correct capitalization, punctuation, and spelling.

Style

- Vary the words you use. Use a dictionary and thesaurus to help you.
- Your writing should be clear and interesting at the same time.
- Use colorful language and different sentence structures.

KEY TERMS

Punctuation: Writing marks that help to separate and clarify ideas. Examples of punctuation are the period, comma, colon, dash, ellipsis, exclamation mark, and question mark. (L2)

Participle: A participle is based on a verb form that functions as an adjective within the sentence. Present participles typically end in *-ing* and past participles typically end in *-ed*. (L1a)

Gerund: A gerund is a present participle that is used as a noun. It can be the subject of a verb, the object of a verb, a predicate nominative or complement, or the object of a preposition. (L1a)

Infinitive: An infinitive is a phrase that consists normally of the word “to” followed by a verb. The phrase can act as a noun, adjective, or adverb within the sentence. Examples are *to swim*, *to learn*, and *to look*. (L1a)

Active Voice: A sentence uses active voice when the subject of the sentence performs the action expressed in the verb. This is a preferred construction for most writing to present ideas clearly and to avoid unnecessary wordiness. An example is *The girl caught the fish*. (L1b)

Passive Voice: A sentence uses passive voice when the subject of the sentence receives the action. An example of active voice is *The fish was caught by the boy*. (L1b)

Indicative Verb: The indicative verb is used to simply state a fact or opinion. (L1c)

Imperative Verb: The imperative verb is used to command or tell someone to take action. It is understood that you are the direct object of the imperative verb. Examples are *eat*, *sit*, and *be*. (L1c)

Interrogative Verb: An interrogative verb used when the author or speaker is asking a question. (L1c)

Conditional Verb: A conditional verb used when a situation is dependent on a particular condition. An example is *I would love to see you if you have some time available today*. (L1c)

Subjunctive Verb: A subjunctive verb that shows something that is contrary to fact. An example is *I wish we would have had dinner earlier.* (L1c)

Context: Words and phrases that surround another phrase and help to explain its meaning. Sometimes a word cannot be understood without the context of other words and phrases. For example, *he sunk it* could mean several things, but when the full sentence is included, *He threw the basketball up high from midcourt and sunk it through the hoop for two points*, the meaning is clear. (L4a)

Root: The foundation of a word. Knowing the meaning of the root can help a reader determine the meaning of its variations. For example, if you know that a *school* is a place that provides knowledge, you may be able to guess that a *scholar* is someone who is seeking knowledge. (L4b)

Irony:

- **Verbal Irony:** An expression a person uses that means the opposite of what is said. (L5a)
- **Dramatic Irony:** An event or other literary element of which the reader is aware but that is unknown to the characters. (L5a)
- **Situational Irony:** An instance in which characters' actions have the opposite effect of what is planned. (L5a)

Pun: A word or phrase with more than one meaning that is used in a funny way. Here is an example from a fable about fish talking: *The first fish tells the second fish that he can just drop him a line when he is ready to talk.* (L5a)

Denotation and Connotation: A connotation is an implied meaning—it is the meaning the writer intends, which may not be the same thing as the literal or dictionary meaning of a word. Denotation is the exact definition of a word. Words can have different connotations depending on how they are used. For example, *polite* and *diplomatic* have similar denotations (respectful, courteous) but can have different connotations (*polite* is more positive, while *diplomatic* connotes that the respectful behavior may be masking other true feelings). (L5c)

Important Tips

- ✍ To study for this part of the EOG assessment, concentrate on the kinds of errors you typically make. Then review grammar rules for those specific kinds of errors. Use books or free online resources to find practice items that you can try. You can work with a partner and question each other on grammar rules or try editing sentences together. Focus your review time on strengthening the areas or skills that need it the most.
- ✍ When you are faced with an unknown word, go back to the passage. Start reading two sentences before the word appears, and continue reading for two sentences afterward or elsewhere in the passage to understand the context in which the word is being used.

Sample Items 18–21

Item 18

Selected-Response

Which of these is the **BEST** way to revise the underlined sentence so that the paragraph is consistently written in the active voice?

We spent many of our summers on the Georgia Sea Islands. The music played by the residents there was inspiring. I would give anything to play that well.

- A. The music was played by residents, and it was inspiring.
- B. Music was played that was inspired by the residents.
- C. Inspiring music was played by the residents.
- D. The residents played inspiring music.

Item 19

Selected-Response

What is the function of the underlined word in the sentence?

Reading is my favorite way to spend a quiet afternoon.

- A. adjective
- B. noun
- C. preposition
- D. verb

Item 20**Selected-Response**

Which sentence uses the correct punctuation between clauses?

- A. I went to the store . . . and I bought paper.
- B. I went to the store—and I bought paper.
- C. I went to the store; and I bought paper.
- D. I went to the store, and I bought paper.

Item 21**Selected-Response**

Which underlined word contains a spelling error?

His facial reaction was quite quizical in nature.

- A. facial
- B. reaction
- C. quizical
- D. nature

ENGLISH LANGUAGE ARTS (ELA) ADDITIONAL SAMPLE ITEM KEYS

Item	Standard/ Element/ Genre	DOK Level	Correct Answer	Explanation
1	ELAGSE8RL3 Literary	2	C	The correct answer is choice (C) He fidgeted with his hat, not knowing where it should go, but certain that it couldn't go back on his head. This shows he is self-conscious. Choice (A) is incorrect. It describes the setting only. Choice (B) is incorrect as it illustrates respect but not being self-conscious. Choice (D) is incorrect as it does not relate to being self-conscious.
2	ELAGSE8RL4 Literary	2	B	The correct answer is choice (B) Caleb was less likely to embarrass himself while he was busy eating. This explains the connotation of <i>merciful</i> . Choice (A) is incorrect because this is not supported in the text. Choice (C) is incorrect because, even though delivering some meals might be an act of mercy, this meal is not charity. Choice (D) is incorrect because the meal was paid for by Bollinger.
3	ELAGSE8RL2 Literary	2	B	The correct answer is choice (B) He should report conditions on the trail. This shows his responsibilities as a Pony Express Rider, so it would belong in a summary. Choices (A), (C), and (D) are incorrect because they are not as important to the passage and would not need to go into a summary. They are details from the passage and not main ideas.
4	ELACC8RL3	3	A/C	The correct answers are (A) a desire to be independent from his family, and (C) He had no words to explain their disappointment at his wanting to chart his own course, not to mention how effortlessly he'd settled into a life on the plains. Caleb's family wants him to work in the family business, but he wants to forge his own path. He feels burdened by his family's expectation that he work in the family business. The answer choice for Part B of the item shows text from the passage that supports this conclusion. In Part A, Choice (B) is incorrect because while the new job is adventurous, Caleb's motivations stems more from the desire for independence. Choice (C) is incorrect because a desire for money is not stated or implied about Caleb. Choice (D) is incorrect as there is no expressed desire or need to travel to other places, though it will be necessitated by the job. The incorrect options in Part B support incorrect answers in Part A.
5	ELAGSE8W3	3	N/A	See scoring rubric beginning on page 64 and sample response on page 57.

Item	Standard/ Element/ Genre	DOK Level	Correct Answer	Explanation
6	ELAGSE8RI1 Informational/ Explanatory	2	B	The correct answer is choice (B) These odd creatures are not only alive, but living in this dark underworld away from light. This supports the conclusion that this is important. Choices (A), (C), and (D) are incorrect because they are details from the text but do not support this conclusion.
7	ELAGSE8RI4 Informational/ Explanatory	2	C	The correct answer is choice (C) extracting. The passage contrasts the way these life forms obtain, or get, energy to the way most life forms get energy. The creatures are extracting energy to stay alive. Choices (A), (B), and (D) are incorrect because <i>depositing</i> , <i>emptying</i> , and <i>wasting</i> would change the meaning of the sentence.
8	ELAGSE8RI5 Informational/ Explanatory	3	N/A	See scoring rubric and sample responses on page 58.
9	ELAGSE8RI2 Informational/ Explanatory	3	N/A	See scoring rubric and sample responses on page 59.
10	ELAGSE8L4a	2	C	The correct answer is choice (C) hungrily eat. Pandas pull bamboo off the trees and eat all day. Choice (A) is incorrect because it refers to grabbing onto the bamboo from the trees but not actually eating it. Ingesting is the act of eating. Choice (B) is incorrect because that is not the meaning of <i>ingest</i> . They are not ruining the bamboo, they are eating it. Choice (D) is incorrect because the pandas eat with more intensity than a nibble.
11	ELAGSE8RI Informational/ Explanatory	2	D	The correct answer is choice (D) Ecotourism helps pandas and the national economy. This is the central idea. Choices (A) and (B) are incorrect because these are supporting details and not the central idea. Choice (C) is incorrect because this is not an accurate description of the central idea, though travel is implied.
12	ELAGSE8W2a	3	N/A	See scoring rubric and sample responses on page 60.
13	ELAGSE8RI3 Informational/ Explanatory	3	N/A	See scoring rubric and sample responses on page 61.
14	ELAGSE8W1b	3	C	The correct answer is choice (C) Customers can then decide to use or ignore the information. Choice (A) is incorrect because it does not support the writer's argument. Choice (B) is incorrect and not related to the argument. Choice (D) is incorrect because it is not supported by information in the passage.

Item	Standard/ Element/ Genre	DOK Level	Correct Answer	Explanation
15	ELAGSE8W1a	2	D	The correct answer is choice (D) Food should look good and taste good. Choices (A), (B), and (C) are incorrect because they are relevant to the sentences.
16	ELAGSE8W2e	2	B	The correct answer is choice (B) In fact, the tastiest foods may be the ones with the most calories. This has a more formal style. Choice (A) is incorrect because “Just go for it” is an informal expression. Choice (C) is incorrect, though this is a close answer, but it is not really as formal a choice (B). Choice (D) is incorrect because “No worries” is very informal.
17	ELAGSE8W1	4	N/A	See scoring rubric beginning on page 68 and sample response on page 62.
18	ELAGSE8L1b	2	D	The correct answer is choice (D) The residents played inspiring music. <i>Played</i> is an active verb. Choices (A), (B), and (C) are all in the passive voice.
19	ELAGSE8L1a	2	B	The correct answer is choice (B) noun. The word <i>reading</i> is a gerund and functions as a noun in this sentence. Choices (A) and (C) are incorrect because the word does not function as either of those parts of speech. Choice (D) is incorrect, though it does end in <i>-ing</i> like some verbs. In this case, <i>reading</i> is a noun that is made from a verb.
20	ELAGSE8L2a	1	D	The correct answer is choice (D) I went to the store, and I bought paper. Choice (A) is incorrect because an ellipsis takes the place of text that is omitted. Choice (B) is incorrect because this is an inappropriate use of the dash. Choice (C) is incorrect because the semicolon is inappropriate.
21	ELAGSE8L2c	1	C	The correct answer is choice (C) quizzical. <i>Quizzical</i> is one of those troublesome words with a double consonant. Choices (A), (B), and (D) are all spelled correctly.

ENGLISH LANGUAGE ARTS (ELA) SAMPLE SCORING RUBRICS AND EXEMPLAR RESPONSES

Item 5

To view the four-point rubric for a text-based narrative response, see pages 64 and 65.

Exemplar Response

Points Awarded	Sample Response
4	Well, I got the job and I didn't make too much of a fool of myself. I think Mr. Bollinger knows about my family's business but he didn't even bring it up. He seems to have high hopes for this mail delivery plan, and he's expressed confidence in me. That means that when I make it, I'll make it on my own. It doesn't look easy, however. I'll be riding all day in all kinds of conditions—storms, rock slides, even the chance I'll be stopped by roadside bandits. It seems like the only thing that really rates is the horse. He only works one-sixth of the day, while I work six-sixths of it. But in a way that makes perfect sense. In any rate, I got the job I wanted. I'm going to succeed. I'll make Bollinger and my family back in West Virginia proud.
3	I don't suppose I'll get good treatment like that every day that I work for the Pony Express, but it sure was a good way to begin. Mr. Bollinger seemed like a good man, and he explained the job very clearly. It's a big responsibility, delivering people's mail. But I can do it. This is why I came out here to work on my own. It also looks like an interesting job. There had better be more going on than herding cattle.
2	Boy, they had everything set up for me. Mr. Bollinger ordered my breakfast. They had the mail pouch ready and my first horse all saddled up. This should be a good group to work for.
1	Twelve hours is a long day, but I can do it. Mr. Bollinger has confidence that I can do it, so I can.
0	I am riding the pony.

Item 8

Scoring Rubric

Points	Description
2	<p>The response achieves the following:</p> <ul style="list-style-type: none"> • Gives sufficient evidence of the ability to analyze the role of specific paragraphs within the text • Includes specific examples/details that make clear reference to the text • Adequately supports examples with clearly relevant information from the text
1	<p>The response achieves the following:</p> <ul style="list-style-type: none"> • Gives limited evidence of the ability to analyze the role of specific paragraphs within the text • Includes limited examples that make reference to the text • Explains examples with vague/limited information from the text
0	<p>The response achieves the following:</p> <ul style="list-style-type: none"> • Gives no evidence of the ability to analyze the role of specific paragraphs within the text

Exemplar Response

Points Awarded	Sample Response
2	At first, the description seems to be of some science fiction world. It sounds strange and exotic. Then we find out that it is the bottom of the ocean that is being described. From the start you know that this is unusual. The purpose of the first paragraph is to make you realize that what is happening with the vents is quite different from what was expected.
1	The first paragraph sounds like a movie or a science fiction story. There are creatures that look like worms, but they have red-and-white stripes. This makes the passage really interesting. And scary.
0	There are giant worms. It's a good beginning.

Item 9

Scoring Rubric

Points	Description
2	<p>The response achieves the following:</p> <ul style="list-style-type: none"> • Gives sufficient evidence of the ability to determine the central idea of a text and analyze its development over the course of the text • Includes specific examples/details that make clear reference to the text • Adequately supports examples with clearly relevant information from the text
1	<p>The response achieves the following:</p> <ul style="list-style-type: none"> • Gives limited evidence of the ability to determine the central idea of a text and analyze its development over the course of the text • Includes limited examples/details that make reference to the text • Explains examples with vague/limited information from the text
0	<p>The response achieves the following:</p> <ul style="list-style-type: none"> • Gives no evidence of the ability to determine the central idea of a text and analyze its development over the course of the text

Exemplar Response

Points Awarded	Sample Response
2	<p>The central idea of the passage is that the discovery of the underwater vents has prompted scientists to reconsider the belief that all living organisms need light to survive. The vents are remarkable because they house colonies of living organisms, despite the fact that they represent an environment too hostile to support life as we know it. The organisms living in these vents exist without sunlight. This shocked scientists. This also means that other organisms may be able to exist under these conditions as well.</p>
1	<p>The vents are at the bottom of the ocean, so the organisms that live there get absolutely no sunlight. They are the only life forms known to exist in the total absence of sunlight. Maybe there's life we don't know about in other places.</p>
0	<p>There are strange things living in the sea. Scientists know about them.</p>

Item 12

Scoring Rubric

Points	Description
2	<p>The exemplar shows a full-credit response. It achieves the following:</p> <ul style="list-style-type: none"> • Gives sufficient evidence of the ability to analyze the structure of the text and how it contributes to the development of ideas • Includes specific examples/details that make clear reference to the text • Adequately supports examples with clearly relevant information from the text
1	<p>The exemplar shows a 1-point response. It achieves the following:</p> <ul style="list-style-type: none"> • Gives limited evidence of the ability to analyze the structure of the text and how it contributes to the development of ideas • Includes vague/limited examples/details that make reference to the text • Supports examples with clearly relevant information from the text
0	<p>The exemplar shows a response that would earn no credit. It achieves the following:</p> <ul style="list-style-type: none"> • Gives no evidence of the ability to analyze the structure of the text and how it contributes to the development of ideas

Exemplar Response

Points Awarded	Sample Response
2	The new heading belongs in front of the last paragraph because that one talks about the risks that come with ecotourism. Ecotourism can help because of the revenues and the awareness. However, more people in an environment can endanger it.
1	It should go before paragraph 5. The word <i>risk</i> is used in paragraph 5 and that shows the other side.
0	The author uses two headings.

Item 13

Scoring Rubric

Points	Description
2	The exemplar shows a full-credit response. It achieves the following: <ul style="list-style-type: none"> • Gives sufficient evidence of how facts and details develop the topic and ideas in a text • Includes specific examples/details that make clear reference to the text • Adequately supports examples with clearly relevant information from the text
1	The exemplar shows a 1-point response. It achieves the following: <ul style="list-style-type: none"> • Gives limited evidence of how facts and details develop the topic and ideas in a text • Includes vague/limited examples/details that make reference to the text • Supports examples with clearly relevant information from the text
0	The exemplar shows a response that would earn no credit. It achieves the following: <ul style="list-style-type: none"> • Gives no evidence of how facts and details develop the topic and ideas in a text

Exemplar Response

Points Awarded	Sample Response
2	The first section talks about pandas and how they are becoming extinct. Then in the second section, the author talks about one way to help save and protect pandas through a program called ecotourism. This is like a problem and a solution. You can help save the pandas by visiting them in their own habitat. And the money you spend for your tour is used to take care of the animal and its habitat.
1	The two sections fit together. The first one tells you that the panda is becoming extinct. The second section tells you one way to help save the panda.
0	Both sections are about pandas.

Item 17

The following is an example of a seven-point response. See the seven-point, two-trait rubric for a text-based argumentative response on pages 68 and 69 to see why this example would earn the maximum number of points.

Example of a Seven-Point Response:

I like being informed. I like to know what will be on a test: not the exact questions, but the material. I watch movie trailers to decide if I'll see a particular movie. And I want to know the nutritional information of the food that I put in my body. Knowing the contents of foods alerts me to ingredients that trigger allergies. In addition, knowing the nutrients and calories helps me balance each meal. Fats, sugars, and carbohydrates are part of many foods, but they can be overdone.

Labeling is not hard for the majority of restaurants because most of them are chains. They already operate in regions with labeling laws, so they already know the contents of each meal. If their hamburger has 560 calories in New York City, it will have 560 calories here. The restaurants unique to our community are small in number and also small in scope. They specialize in seafood or Thai cuisine. The similarity of offerings will make labeling nearly automatic. Whether difficult or easy, presenting the nutritional information of food is critical to the health of the consumer.

I do have some sympathy for the government argument and also for the fact that fewer than half of consumers will probably care. There was a time when the government required manufacturers to put seat belts in cars, and later air bags and anti-lock brakes. At first people resisted wearing the belts and complained about the increased cost. Yet, who would buy a car without those features today? The same will be true for labeling. People will eventually come to realize that they are better off knowing this information to be active participants in promoting their own health.

In the meantime, people can pay attention or not. It is their choice. My choice will be to read the contents and eat healthy.

ENGLISH LANGUAGE ARTS (ELA) WRITING RUBRICS

Grade 8 items that are not machine-scored—i.e., constructed-response, extended constructed-response, and extended writing response items—are manually scored using either a holistic rubric or a two-trait rubric.

Four-Point Holistic Rubric

Genre: Narrative

A holistic rubric evaluates one major feature, which is ideas. On the Georgia Milestones EOG assessment, a holistic rubric is scored from zero to four. Each point value represents the difference in the levels or quality of the student’s work. To score an item on a holistic rubric, the scorer need only choose the description and associated point value that best represents the student’s work. Increasing point values represent a greater understanding of the content and, thus, a higher score.

Seven-Point, Two-Trait Rubric

Genre: Argumentative or Informational/Explanatory

A two-trait rubric, on the other hand, evaluates two major traits, which are conventions and ideas. On the Georgia Milestones EOG assessment, a two-trait rubric contains two scales, one for each trait, ranging from zero to three on one scale (conventions) and zero to four on the other (ideas). A score is given for each of the two traits, for a total of seven possible points for the item. To score an item on a two-trait rubric, a scorer must choose the description and associated point value for each trait that best represents the student’s work. The two scores are added together. Increasing point values represent a greater understanding of the content and, thus, a higher score.

On the following pages are the rubrics that will be used to evaluate writing on the Georgia Milestones Grade 8 English Language Arts EOG assessment.

Four-Point Holistic Rubric

Genre: Narrative

Writing Trait	Points	Criteria
<p><i>This trait examines the writer's ability to effectively develop real or imagined experiences or events using effective techniques, descriptive details, and clear event sequences based on a text that has been read.</i></p>	4	<p><i>The student's response is a well-developed narrative that fully develops a real or imagined experience based on text as a stimulus.</i></p> <ul style="list-style-type: none"> • Effectively establishes a situation and a point of view and introduces a narrator and/or characters • Organizes an event sequence that unfolds naturally and logically • Effectively uses narrative techniques, such as dialogue, description, pacing, and reflection, to develop rich, interesting experiences, events, and/or characters • Uses a variety of words and phrases consistently and effectively to convey the sequence of events, signal shifts from one time frame or setting to another, and show the relationships among experiences and events • Uses precise words, phrases, and sensory language to convey experiences and events and capture the action • Provides a conclusion that follows from the narrated experiences or events • Integrates ideas and details from source material effectively • Has very few or no errors in usage and/or conventions that interfere with meaning*
	3	<p><i>The student's response is a complete narrative that develops a real or imagined experience based on text as a stimulus.</i></p> <ul style="list-style-type: none"> • Establishes a situation and introduces one or more characters • Organizes events in a clear, logical order • Uses narrative techniques, such as dialogue, description, pacing, and reflection, to develop experiences, events, and/or characters • Uses words and/or phrases to indicate sequence, signal shifts from one time frame or setting to another, and show the relationships among experiences and events • Uses words, phrases, and details to capture the action and convey experiences and events • Provides an appropriate conclusion • Integrates some ideas and/or details from source material • Has a few minor errors in usage and/or conventions that interfere with meaning*

Four-Point Holistic Rubric

Genre: Narrative (continued)

Writing Trait	Points	Criteria
<p><i>This trait examines the writer's ability to effectively develop real or imagined experiences or events using effective techniques, descriptive details, and clear event sequences based on a text that has been read.</i></p>	2	<p><i>The student's response is an incomplete or oversimplified narrative based on text as a stimulus.</i></p> <ul style="list-style-type: none"> • Introduces a vague situation and at least one character • Organizes events in a sequence but with some gaps or ambiguity • Attempts to use a narrative technique, such as dialogue, description, pacing, or reflection, to develop experiences, events, and/or characters • Uses occasional signal words inconsistently and ineffectively to indicate sequence, signal shifts from one time frame or setting to another, or show the relationships among experiences and events • Uses some words or phrases inconsistently and ineffectively to convey experiences, and events, and capture the action • Provides a weak or ambiguous conclusion • Attempts to integrate ideas or details from source material • Has frequent errors in usage and conventions that sometimes interfere with meaning*
	1	<p><i>The student's response provides evidence of an attempt to write a narrative based on text as a stimulus.</i></p> <ul style="list-style-type: none"> • Response is a summary of the story. • Provides a weak or minimal introduction of a situation or character • May be too brief to demonstrate a complete sequence of events, or signal shifts in one time frame or setting to another, or show relationships among experiences and events • Shows little or no attempt to use dialogue, description, pacing, or reflection to develop experiences, events, and/or characters • Uses words that are inappropriate, overly simple, or unclear • Provides few, if any, words to convey experiences, or events, or capture the action • Provides a minimal or no conclusion • May use few, if any, ideas or details from source material • Has frequent major errors in usage and conventions that interfere with meaning*
	0	<p><i>The student's response is flawed for various reasons and will receive a condition code:</i></p> <p>The condition codes can be found on page 220 of this guide.</p>

* Students are responsible for language conventions learned in their current grade as well as in prior grades. Refer to the language skills for each grade to determine the grade-level expectations for grammar, syntax, capitalization, punctuation, and spelling. Also refer to the "Language Progressive Skills, by Grade" chart in Appendix A for those standards that need continued attention beyond the grade in which they were introduced.

Seven-Point, Two-Trait Rubric

Trait 1 for Informational/Explanatory Genre

Writing Trait	Points	Criteria
<p>Idea Development, Organization, and Coherence</p> <p><i>This trait examines the writer's ability to effectively establish a controlling idea and to support the idea with evidence from the text(s) read and to elaborate on the idea with examples, illustrations, facts, and other details in order. The writer must integrate the information from the text(s) into his/her own words and arrange the ideas and supporting evidence (from text that they have read) in order to create cohesion for an informative/explanatory essay.</i></p>	4	<p><i>The student's response is a well-developed informative/explanatory text that examines a topic in depth and conveys ideas and information clearly based on text as a stimulus.</i></p> <ul style="list-style-type: none"> • Effectively introduces a topic • Effectively organizes ideas, concepts, and information using various strategies such as definition, classification, comparison/contrast, and cause/effect • Effectively develops the topic with multiple, relevant facts, definitions, concrete details, quotations, or other information and examples related to the topic • Effectively uses appropriate and varied transitions to create cohesion and clarify the relationships among ideas and concepts • Uses precise language and domain-specific vocabulary to inform about or explain the topic • Establishes and maintains a formal style • Provides a strong concluding statement or section that follows from and supports the information or explanation presented
	3	<p><i>The student's response is a complete informative/explanatory text that examines a topic and presents information based on a text as a stimulus.</i></p> <ul style="list-style-type: none"> • Introduces a topic • Generally organizes ideas, concepts, and information • Develops the topic with a few facts, definitions, concrete details, quotations, or other information and examples • Uses some transitions to connect and clarify relationships among ideas, but relationships may not always be clear • Uses some precise language and domain-specific vocabulary to explain the topic • Maintains a formal style, for the most part • Provides a concluding statement or section
	2	<p><i>The student's response is an incomplete or oversimplified informative/explanatory text that cursorily examines a topic.</i></p> <ul style="list-style-type: none"> • Attempts to introduce a topic • Attempts to develop a topic with too few details • Ineffectively organizes ideas, concepts, and information • Uses limited language and vocabulary that does not inform or explain the topic • Uses few transitions to connect and clarify relationships among ideas • Uses a formal style inconsistently or uses an informal style • Provides a weak concluding statement or section
	1	<p><i>The student's response is a weak attempt to write an informative/explanatory text that examines a topic.</i></p> <ul style="list-style-type: none"> • May not introduce a topic or topic is unclear • May not develop a topic • May be too brief to group any related ideas together • May not use any linking words to connect ideas • Uses vague, ambiguous, or repetitive language • Uses a very informal style • Provides a minimal or no concluding statement or section
	0	<p><i>The student's response is flawed for various reasons and will receive a condition code: The condition codes can be found on page 220 of this guide.</i></p>

Seven-Point, Two-Trait Rubric

Trait 2 for Informational/Explanatory Genre

Writing Trait	Points	Criteria
Language Usage and Conventions <i>This trait examines the writer's ability to demonstrate control of sentence formation, usage, and mechanics as embodied in the grade-level expectations of the language standards.</i>	3	<i>The student's response demonstrates full command of language usage and conventions.</i> <ul style="list-style-type: none"> • Effectively varies sentence patterns for meaning, reader/listener interest, and style • Shows command of language and conventions when writing • Any errors in usage and conventions do not interfere with meaning*
	2	<i>The student's response demonstrates partial command of language usage and conventions.</i> <ul style="list-style-type: none"> • Varies some sentence patterns for meaning, reader/listener interest, and style • Shows some knowledge of languages and conventions when writing • Has minor errors in usage and conventions with no significant effect on meaning*
	1	<i>The student's response demonstrates weak command of language usage and conventions.</i> <ul style="list-style-type: none"> • Has fragments, run-ons, and/or other sentence structure errors • Shows little knowledge of languages and conventions when writing • Has frequent errors in usage and conventions that interfere with meaning*
	0	<i>The student's response is flawed for various reasons and will receive a condition code:</i> The condition codes can be found on page 220 of this guide.

* Students are responsible for language conventions learned in their current grade as well as in prior grades. Refer to the language skills for each grade to determine the grade-level expectations for grammar, syntax, capitalization, punctuation, and spelling. Also refer to the "Language Progressive Skills, by Grade" chart in Appendix A for those standards that need continued attention beyond the grade in which they were introduced.

Seven-Point, Two-Trait Rubric
Trait 1 for Argumentative Genre

Writing Trait	Points	Criteria
<p>Idea Development, Organization, and Coherence</p> <p><i>This trait examines the writer's ability to effectively establish a claim as well as to address counterclaims, to support the claim with evidence from the text(s) read, and to elaborate on the claim with examples, illustrations, facts, and other details. The writer must integrate the information from the text(s) into his/her own words and arrange the ideas and supporting evidence in order to create cohesion for an argument essay.</i></p>	4	<p><i>The student's response is a well-developed argument that effectively relates and supports claims with clear reasons and relevant text-based evidence.</i></p> <ul style="list-style-type: none"> • Effectively introduces claim(s) • Uses an organizational strategy to present reasons and relevant evidence logically • Supports claim(s) with clear reasons and relevant evidence using specific, well-chosen facts, details, or other information from credible sources and demonstrates a good understanding of the topic or texts • Acknowledges and counters opposing claim(s), as appropriate • Uses words, phrases, and/or clauses that effectively connect and show direct, strong relationships among claim(s), reasons, and evidence • Establishes and maintains a formal style that is appropriate for the task, purpose, and audience • Provides a strong concluding statement or section that logically follows from the argument presented
	3	<p><i>The student's response is a complete argument that relates and supports claims with some text-based evidence.</i></p> <ul style="list-style-type: none"> • Clearly introduces claim(s) • Uses an organizational strategy to present some reasons and evidence • Uses specific facts, details, definitions, examples, and/or other information from sources to develop claim(s) • Attempts to acknowledge and/or counter opposing claim(s), as appropriate • Uses words and/or phrases to connect ideas and show relationships among claim(s), reasons, and evidence • Uses a formal style fairly consistently for task, purpose, and audience • Provides a concluding statement or section that follows from the argument presented
	2	<p><i>The student's response is an incomplete or oversimplified argument that partially supports claims with loosely related, text-based evidence.</i></p> <ul style="list-style-type: none"> • Attempts to introduce claim(s) • Attempts to use an organizational structure which may be formulaic • Develops, sometimes unevenly, reasons and/or evidence to support claim(s) • Makes little, if any, attempt to acknowledge or counter opposing claim(s) • Attempts to support claim(s) with facts, reasons, and other evidence sometimes, but logic and relevancy are often unclear • Uses few words or phrases to connect ideas; connections are not always clear • Uses a formal style inconsistently or an informal style that does not fit task, purpose, or audience • Provides a weak concluding statement or section that may not follow the argument presented
	1	<p><i>The student's response is a weak attempt to write an argument and does not support claims with adequate text-based evidence.</i></p> <ul style="list-style-type: none"> • May not introduce claim(s)/claims(s) must be inferred • May be too brief to demonstrate an organizational structure, or no structure is evident • Has minimal support for claim(s) • Makes no attempt to acknowledge or counter opposing claim(s) • Uses minimal or no words or phrases to connect ideas • Uses a very informal style that is not appropriate for task, purpose, or audience • Provides a minimal or no concluding statement or section
	0	<p><i>The student's response is flawed for various reasons and will receive a condition code: The condition codes can be found on page 220 of this guide.</i></p>

Seven-Point, Two-Trait Rubric
Trait 2 for Argumentative Genre

Writing Trait	Points	Criteria
Language Usage and Conventions <i>This trait examines the writer's ability to demonstrate control of sentence formation, usage, and mechanics as embodied in the grade-level expectations of the language standards.</i>	3	<i>The student's response demonstrates full command of language usage and conventions.</i> <ul style="list-style-type: none"> • Effectively varies sentence patterns for meaning, reader/listener interest, and style • Shows command of language and conventions when writing • Any errors in usage and conventions do not interfere with meaning*
	2	<i>The student's response demonstrates partial command of language usage and conventions.</i> <ul style="list-style-type: none"> • Varies some sentence patterns for meaning, reader/listener interest, and style • Shows some knowledge of languages and conventions when writing • Has minor errors in usage and conventions with no significant effect on meaning*
	1	<i>The student's response demonstrates weak command of language usage and conventions.</i> <ul style="list-style-type: none"> • Has fragments, run-ons, and/or other sentence structure errors • Shows little knowledge of languages and conventions when writing • Has frequent errors in usage and conventions that interfere with meaning*
	0	<i>The student's response is flawed for various reasons and will receive a condition code:</i> The condition codes can be found on page 220 of this guide.

* Students are responsible for language conventions learned in their current grade as well as in prior grades. Refer to the language skills for each grade to determine the grade-level expectations for grammar, syntax, capitalization, punctuation, and spelling. Also refer to the "Language Progressive Skills, by Grade" chart in Appendix A for those standards that need continued attention beyond the grade in which they were introduced.

ACTIVITY

The following activity develops skills in Unit 1: Reading Literary Text.

Standards: ELAGSE8.RL.1, ELAGSE8.RL.2, ELAGSE8.RL.3, ELAGSE8.RL.4, ELAGSE8.RL.5, ELAGSE8.RL.6, and ELAGSE8.RL.9

The Daily Reporter

Get your pad, pen, and press badge and join the staff of *The Daily Reporter* news team! You can do the following activity with friends or on your own.

Interview with a Friend or Family Member

You will need a reporter and a character from a story, novel, or play to interview.

- Choose a character you have read about and answer all questions as that character.
- The reporter should ask questions that pertain to events that took place in the story, novel, or play that the character comes from.
- You can also ask questions that require the character to reveal thoughts, feelings, and reactions to events and other characters.
- Think about what the character is like and what caused specific events to take place.
- The character may be asked to make a judgment or draw a conclusion about people and events from the text.
- The reporter will ask the character questions and record the responses.

Example: You have just read *To Kill a Mockingbird* by Harper Lee. The reporter can interview Atticus Finch and ask him how he felt about the trial or its outcome, or you may choose to interview Scout and get her reaction to how the trial affected her father or what she thinks about growing up in Maycomb, Alabama.

After the interview, the questions and answers can be presented in several ways.

- Write a newspaper report. If you have access to a computer, you can design a page that looks like the front page of a newspaper.
- Write the interview as a dialogue between the reporter and the character.
- Present this as a live interview on a TV news show. You can set up two chairs at the front of the class and interview the character using the questions and answers as the script.

On Your Own

You can do this activity on your own after reading a story, novel, or play. Choose a character who interests you and write the questions and answers yourself. Prepare the questions and answers as either a newspaper report or a dialogue.

ACTIVITY

The following activity develops skills in Unit 5: Language.

Standards: ELAGSE8.L.4 and ELAGSE8.L.5

Word Match Game

You can play this game by yourself, with a friend, or with your family.

Create a list of vocabulary words. These words can come from your reading, spelling lists, or the glossaries of science, math, or social studies textbooks.

Write each word on an index card. If you do not have blank cards, take a sheet of paper and fold it in half. Then fold it in half a second time so that there are four rectangles. Cut these rectangles apart.

- Write a word on each card or piece of paper.
- On a different index card or piece of paper, write a synonym or definition of the word.

Start with eight words and their matching definitions.

- Mix them up and put the cards face up on the table in four rows of four cards each.

Find a word and its matching definition and turn it over.

- You can do this yourself, take turns with a friend or family member, or let each person see if he or she can match the eight words on his or her own.

Keep playing with the next set of eight words.

Play this game just for fun or to review words before a test or quiz.

- You can also use it as a way to study with a friend and test each other on how well you know the definitions of each word.

As an alternate way of playing, get a timer. Set the timer for a minute or use an hourglass timer that is filled with sand and turn it over.

- When time is up, count how many words were correctly matched.
- Award two points for each match.
- The player with the most points at the end of the game wins.

MATHEMATICS

DESCRIPTION OF TEST FORMAT AND ORGANIZATION

The Grade 8 Mathematics EOG assessment consists of a total of 73 items.

You will answer a variety of item types on the test. Some of the items are selected response (multiple-choice), which means you choose the correct answer from four choices. Some items will ask you to write your response.

The test will be given in two sections.

- You may have up to 85 minutes per section to complete Sections 1 and 2.
- The test will take about 120 to 170 minutes.

CONTENT

The Grade 8 Mathematics EOG assessment will measure the Grade 8 standards that are described at www.georgiastandards.org.

The content of the assessment covers standards that are reported under these domains:

- Numbers, Expressions, and Equations
- Algebra and Functions
- Geometry
- Statistics and Probability

ITEM TYPES

The Mathematics portion of the Grade 8 EOG assessment consists of selected-response (multiple-choice), technology-enhanced (multiple-select or two-part), constructed-response, and extended constructed-response items.

MATHEMATICS DEPTH OF KNOWLEDGE EXAMPLE ITEMS

Example items that represent applicable DOK levels of the Mathematics assessment are provided for you on the following pages. The items and explanations of what is expected of you to answer them will help you prepare for the test.

All example and sample items contained in this guide are the property of the Georgia Department of Education.

Example Item 1

Selected-Response

DOK Level 1: This is a DOK level 1 item because it requires students to recall a square root.

Mathematics Grade 8 Content Domain II: Numbers, Expressions, and Equations

Standard: MGSE8.NS.2. Use rational approximation of irrational numbers to compare the size of irrational numbers, locate them approximately on a number line, and estimate the value of expressions (e.g., estimate π^2 to the nearest tenth). *For example, by truncating the decimal expansion of $\sqrt{2}$ (square root of 2), show that $\sqrt{2}$ is between 1 and 2, then between 1.4 and 1.5, and explain how to continue on to get better approximations.*

Which of these is the closest approximation to the value of $\sqrt{97}$?

- A. 9
- B. 10
- C. 48
- D. 49

Correct Answer: B

Explanation of Correct Answer: The correct answer is choice (B) 10. The square root of 97 is between the perfect squares 81 and 100, but it is closer to the square root of 100. Choice (A) is incorrect because the square root of 81 is 9, but the square root of 100 is 10, which the square root of 97 is closer to. Choice (C) is incorrect because it is a result of dividing 97 by 2 and incorrectly rounding down. Choice (D) is incorrect because it is a result of dividing 97 by 2 and rounding up.

Scoring Rubric

Points	Description
2	<p>The response achieves the following:</p> <ul style="list-style-type: none"> The response demonstrates a complete understanding of constructing functions to model a linear relationship between quantities. Give 2 points for the correct rate of change and identifying the correct equation and rationale. <ul style="list-style-type: none"> Response is correct and complete. Response shows application of a reasonable and relevant strategy. Mathematical ideas are expressed coherently through a clear, complete, logical, and fully developed response using words, calculations, and/or symbols, as appropriate.
1	<p>The response achieves the following:</p> <ul style="list-style-type: none"> The response demonstrates a partial understanding of constructing functions to model a linear relationship between quantities. Give 1 point if Part A OR Part B is correct. <ul style="list-style-type: none"> Response is mostly correct, but contains either a computational error or an unclear or incomplete explanation. Response shows application of a relevant strategy, though it may be only partially applied or remain unexplained. Mathematical ideas are expressed only partially using words, calculations, and/or symbols, as appropriate.
0	<p>The response achieves the following:</p> <ul style="list-style-type: none"> Response demonstrates limited to no understanding of constructing functions to model a linear relationship between quantities. <ul style="list-style-type: none"> Response is incorrect. Response shows no application of a strategy. Mathematical ideas cannot be interpreted or lack sufficient evidence to support even a limited understanding.

Exemplar Response

Points Awarded	Sample Response
2	<p>Part A: 2 Part B: Yes. The equation represents the function because it is a linear function with a slope of 2 and an initial value of 3. <i>OR other valid explanation</i></p>
1	<p>Part A: 2 Part B: No. The equation does not represent the function because its initial value should be negative.</p>
0	<p><i>Response is irrelevant, inappropriate, or not provided.</i></p>

Example Item 3

Extended Constructed-Response

DOK Level 3: This is a DOK level 3 item that assesses complex reasoning. Students have to apply their knowledge of decimals and explain their reasoning. It is also an example of an extended constructed-response item.

Mathematics Grade 8 Content Domain II: Numbers, Expressions, and Equations

Standard: MGSE8.NS.1. Know that numbers that are not rational are called irrational. Understand informally that every number has a decimal expansion; for rational numbers, show that the decimal expansion repeats eventually, and convert a decimal expansion, which repeats eventually into a rational number.

Part A: Is $0.\overline{571428}$ the decimal equivalent of $\frac{4}{7}$? Explain your reasoning.

Part B: Is the number in Part A rational or irrational? Explain your reasoning.

Part C: What is $0.\overline{166}$ written as a fraction?

Part D: Is the number in Part C rational or irrational? Explain your reasoning.

Scoring Rubric

Points	Description
4	<p>The response achieves the following:</p> <ul style="list-style-type: none"> • The response demonstrates a complete understanding of calculating decimal equivalents of fractions and recognizing repeating decimals as rational numbers. • Give 4 points for four parts answered correctly. <ul style="list-style-type: none"> • Response is correct and complete. • Response shows application of a reasonable and relevant strategy. • Mathematical ideas are expressed coherently through a clear, complete, logical, and fully developed response using words, calculations and/or symbols, as appropriate.
3	<p>The response achieves the following:</p> <ul style="list-style-type: none"> • The response demonstrates a nearly complete understanding of calculating decimal equivalents of fractions and recognizing repeating decimals as rational numbers. • Give 3 points for three parts answered correctly or for two parts correct and two parts partially correct. <ul style="list-style-type: none"> • Response is mostly correct, but contains either a computational error or an unclear or incomplete explanation. • Response shows application of a relevant strategy, though it may be only partially applied or remain unexplained. • Mathematical ideas are expressed only partially using words, calculations, and/or symbols, as appropriate.
2	<p>The response achieves the following:</p> <ul style="list-style-type: none"> • The response demonstrates a partial understanding of calculating decimal equivalents of fractions and recognizing repeating decimals as rational numbers. • Give 2 points for two parts answered correctly or for three parts partially correct. <ul style="list-style-type: none"> • Response is only partially correct. • Response shows application of a relevant strategy, though it may be only partially applied or remain unexplained. • Mathematical ideas are expressed only partially using words, calculations, and/or symbols, as appropriate.
1	<p>The response achieves the following:</p> <ul style="list-style-type: none"> • The response demonstrates a minimal understanding of calculating decimal equivalents of fractions and recognizing repeating decimals as rational numbers. • Give 1 point for one part answered correctly or for two parts partially correct. <ul style="list-style-type: none"> • Response is only partially correct. • Response shows incomplete or inaccurate application of a relevant strategy. • Mathematical ideas are expressed only partially using words, calculations, and/or symbols, as appropriate.

Points	Description
0	<p>The response achieves the following:</p> <ul style="list-style-type: none"> • The response demonstrates limited to no understanding of calculating decimal equivalents of fractions and recognizing repeating decimals as rational numbers. • Response is incorrect. • Response shows no application of a strategy. • Mathematical ideas cannot be interpreted or lack sufficient evidence to support even a limited understanding.

Exemplar Response

Points Awarded	Sample Response
4	<p>Part A: Yes, it is the correct decimal equivalent of the fraction. I know because I divided the numerator, 4, by the denominator, 7. The quotient was the given repeating decimal. AND Part B: The number is rational because by dividing 7 into 4, you eventually start repeating a pattern that leads to a repeating decimal. Repeating decimals are rational numbers. AND Part C: 166/999 Part D: The number is rational because any number that can be written as a fraction with nonzero integers in the numerator and denominator is a rational number.</p>
3	The student correctly answers three out of the four parts.
2	The student correctly answers two out of the four parts.
1	The student correctly answers one of the four parts.
0	<i>Response is irrelevant, inappropriate, or not provided.</i>

MATHEMATICS CONTENT DESCRIPTION AND ADDITIONAL SAMPLE ITEMS

In this section, you will find information about what to study in order to prepare for the Grade 8 Mathematics EOG assessment. This includes key terms and important vocabulary words. This section also contains practice questions, with an explanation of the correct answers, and activities that you can do on your own or with your classmates or family to prepare for the assessment.

All example and sample items contained in this guide are the property of the Georgia Department of Education.

CONTENT DESCRIPTION

- Apply and extend understanding of rational numbers
- Work with radicals and integer exponents
- Understand congruence and similarity using physical models or software
- Apply the Pythagorean theorem
- Solve real-world and mathematical problems involving volume of cylinders, cones, and spheres
- Understand the connections between proportional relationships, lines, and linear equations
- Analyze and solve linear equations
- Define, evaluate, and compare functions, and use functions to model relationships between quantities
- Investigate patterns of association in bivariate data

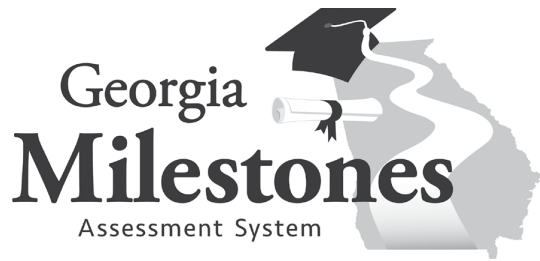

Mathematics Formula Sheet

You can find mathematics formula sheets on the Georgia Milestones webpage at <http://www.gadoe.org/Curriculum-Instruction-and-Assessment/Assessment/Pages/Georgia-Milestones-Assessment-System.aspx>.

Look under “EOG Resources.”

Unit 1: Transformations, Congruence, and Similarity

In this unit, you will work with transformations and identify and compare similar and congruent figures. You will identify and measure angles and study line segments.

KEY TERMS

Transformation: The movement of a figure by performing the same operation or movement on each point of the figure.

- **Rotation:** Turns a figure around a fixed point. Movement is described by an angle of rotation and a direction the figure is turned.
- **Reflection:** Flips a figure over a line of reflection.
- **Translation:** Sliding or moving all points of a figure a specific distance in a given direction.
- **Dilation:** Changing the size of a figure based on a scale factor. The scale factor is applied to the distance from a fixed center to each point of the figure. (G.1)

Transformations do not change the shape or relationship between attributes of a figure. A **line segment** will remain a line segment and will not change size unless the figure is dilated. **Angles** will remain the same **degree of measure** in all figures. Also, **parallel lines** will remain parallel. (G.1)

Congruent figures: Shapes that have the same size and shape, the result of any combination of rotations, reflections, or translations. (G.2)

An effect of a transformation can be described using the **coordinates** on the **coordinate plane** of the original figure and the transformed figure. (G.3)

Similar figures: Shapes that have the same shape but different sizes, the result of any combination of rotations, reflections, translations, and dilations. (G.4)

Describe the **sequence of transformations** that a two-dimensional shape undergoes to result in a **congruent** or **similar** figure. This includes the type of transformation, angle of rotation, reflection line, distance and direction translated, and the factor of dilation. (G.2, G.4)

The measure of an **exterior angle** of a triangle is equal to the sum of the two **opposite interior angles**. The two opposite angles do not share a side or vertex with the exterior angle. (G.5)

A set of **parallel lines** that is cut by a **transversal** results in **alternate angles** that are congruent and same-side angles that are supplementary. (G.5)

Transversal: A line crossing two or more lines. (G.5)

Alternate angles: A pair of angles formed when a transversal crosses two parallel lines. The angles are on the opposite sides of the transversal and on either the **interior** or the **exterior** of the parallel lines. The angles are equal or congruent. (G.5)

Same-side angles: A pair of angles formed when a transversal crosses two parallel lines. The angles are on the same side of the transversal and on either the **interior** or the **exterior** of the parallel lines. The angles are supplementary, or have a sum of 180° . (G.5)

To determine whether two triangles are similar, compare **corresponding sides** or **corresponding angles**. The length of all three pairs of corresponding sides will be proportional. Or, the measures of the angles can be compared and each pair of corresponding angles will be equal.

Important Tips

- ✍ Two congruent figures have the same size and shape. Two similar figures have the same shape and angle measures. The length of each corresponding side is proportional to the original figure using a scale factor.
- ✍ A scale factor or factor of dilation that is greater than 1 will increase the size of the shape. A factor of dilation that is less than 1 will decrease the size of the shape.

Sample Items 1–3**Item 1****Selected-Response**

Look at the graph of a line segment before and after a transformation occurred.

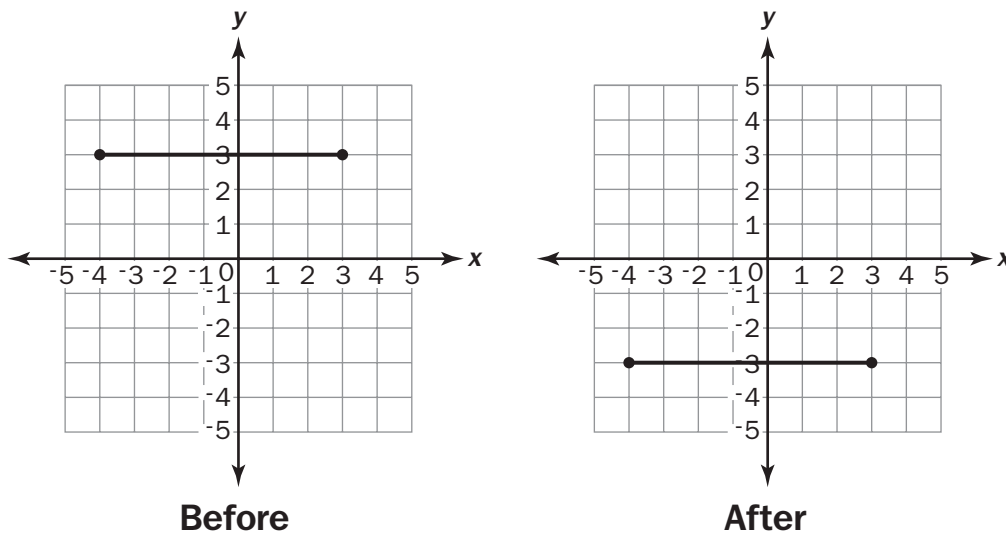

Which statement describes the transformation that could have been made on the line segment?

- A. The line segment was dilated by a factor of $\frac{1}{2}$.
- B. The line segment was rotated 180° counterclockwise about the origin.
- C. The line segment was reflected over the x-axis.
- D. The line segment was translated 6 units down and 1 unit left.

Item 2

Extended Constructed-Response

Quadrilaterals $ABCD$, $A'B'C'D'$, and $A''B''C''D''$ are shown on the graph.

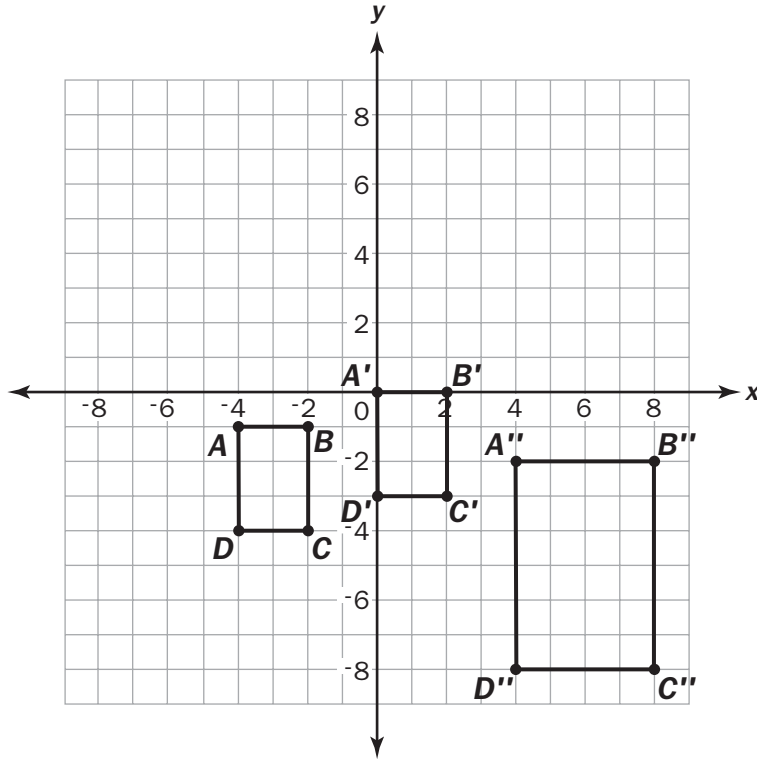

Part A: Describe a transformation or sequence of transformations to quadrilateral $ABCD$ that would result in an image quadrilateral with the coordinates $A'(0, 0)$, $B'(2, 0)$, $C'(2, -3)$, and $D'(0, -3)$.

Part B: A sequence of transformations to quadrilateral $A'B'C'D'$ that would result in an image quadrilateral $A'B'C'D'$, as shown in the graph, starts with a dilation about the origin. This is followed by a horizontal and a vertical translation. Name the horizontal and vertical translation.

Part C: What is the scale factor of the dilation described in Part B?

Part D: Is there another sequence of transformations that could result in the same coordinates? Explain your reasoning.

Item 3**Selected-Response**

A line segment on a graph has endpoints of $(-3, 1)$ and $(3, 1)$. It is translated 5 units down and reflected across the x -axis.

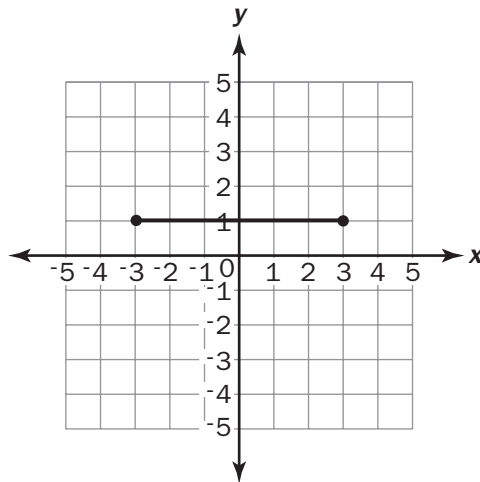

What are the endpoints after the series of transformations?

- A. $(-3, -4)$ and $(3, 4)$
- B. $(-3, -1)$ and $(3, -1)$
- C. $(-3, 4)$ and $(3, 4)$
- D. $(-3, -6)$ and $(3, -6)$

Unit 2: Exponents

In this unit, you will work with exponents, square roots, rational and irrational numbers, and scientific notation.

KEY TERMS

Exponent: Represents repeated multiplication and is one strategy for representing very large or very small numbers. For example, $10 \cdot 10 \cdot 10 = 10^3$, so 10 is multiplied by itself 3 times, and the base of 10 is written with an exponent of 3. The same strategy for writing exponents can be used with any number or variable. (EE.1)

Square root: One of two equal factors that equals a nonnegative number. For example, $\sqrt{9} = 3$ because $3^2 = 3 \cdot 3 = 9$. (EE.2)

Perfect square: A number with a square root that is a rational number. (EE.2)

Cube root: One of three equal factors that equals a nonnegative number. For example, $\sqrt[3]{27} = 3$ because $3^3 = 3 \cdot 3 \cdot 3 = 27$. (EE.2)

Scientific notation: A product of a number (between 1 and 10) and a power of 10. (EE.3)

Perform **operations** (add, subtract, multiply, and divide) with numbers containing exponents, including scientific notation. Scientific notation represents one value that can be added, subtracted, multiplied, and divided using the strategies for operations on multi-digit whole numbers and decimals. (EE.4)

Solve **linear equations** that include one **variable**. The linear equations can include **coefficients** or use the variable on both sides of the equation. Use the **properties of operations** including the **distributive property**, **addition property of equality**, and the **multiplication property of equality** to find the solution to the equation. (EE.7)

Distributive property: Multiplies a factor that is outside of a set of parentheses with each addend within the parentheses to solve. (EE.7)

Addition property of equality: Adding the same number or value to both sides of an equation results in equivalent equations. (EE.7)

Multiplication property of equality: Multiplying the same number or value to both sides of an equation results in equivalent equations. (EE.7)

Rational number: a ratio of two integers written as a repeating or terminating decimal. (NS.1)

Irrational number: a number that cannot be written as the ratio of two integers and is a nonrepeating and nonterminating decimal. (NS.1)

To **compare** irrational numbers, approximate the value of the **irrational numbers** and place on the **number line** between the nearest rational numbers. An **approximation** of an irrational number can also be used to **estimate** the value of an expression containing an irrational number. For example, $5 \cdot \sqrt{2}$ can be estimated using $5 \cdot 1.4 = 7$. (NS.2)

Important Tip

- ✍ Scientific notation is used to represent numbers that are very large or very small. The power of 10 can have a positive exponent to represent larger numbers. For example, $3 \times 10^3 = 3,000$. The power of 10 can also have a negative exponent to represent smaller numbers. For example, $3 \times 10^{-3} = 3 \cdot \frac{1}{10^3} = 0.003$.

Sample Items 4–6**Item 4****Selected-Response**

Between which two integers is the value of $\sqrt{21}$?

- A. 0 to 1
- B. 4 to 5
- C. 6 to 7
- D. 10 to 11

Item 5**Selected-Response**

A grain of sand has a mass of approximately 6×10^{-2} grams. Earth has a mass of approximately 6×10^{28} grams.

How many times smaller is the mass of the grain of sand than the mass of Earth?

- A. 1×10^{-54}
- B. 1×10^{-14}
- C. 1×10^{26}
- D. 1×10^{30}

Unit 3: Geometric Applications of Exponents

In this unit, you will work with the Pythagorean theorem and determine the lengths of sides of triangles. You will determine the distance between two points on a grid and find the volume of three-dimensional figures. You will learn to simplify expressions that include exponents, squares, cubes, square roots, and cubed roots using the properties of operations.

KEY TERMS

Pythagorean theorem: states that the squared length of the hypotenuse in a right triangle equals the sum of the squared lengths of the other two sides. This is often written as $a^2 + b^2 = c^2$. (G.6)

The **converse of the Pythagorean theorem** states that if the squared length of the longest side is equal to the sum of the squared length of the two shorter sides, then the triangle is a right triangle. (G.6)

The formula for the **Pythagorean theorem** can be used to determine unknown side lengths in a right triangle by inserting both known lengths into the formula and solving for the variable. (G.7)

The formula for the **Pythagorean theorem** can be used to determine the distance between two points by creating a right triangle along the coordinate grid. The distance between the two points is the length of the hypotenuse. (G.8)

Volume: The amount of space that an object or a three-dimensional figure occupies.

- **Cone:** A figure with one vertex and a circular or elliptical base. Find the volume using $V = \frac{1}{3} \pi r^2 h$.
- **Sphere:** A figure that has all points equidistant from the center. Find the volume using $V = \frac{4}{3} \pi r^3$.
- **Cylinder:** A figure that has two congruent circular bases that are parallel. Find the volume using $V = \pi r^2 h$. (G.9)

Simplify **expressions** that include **exponents, squares, cubes, square roots, and cubed roots** using the properties of operations.

- **Distributive property** multiplies a factor that is outside of a set of parentheses with each addend within the parentheses to solve.
- **Commutative property** allows for addends in an addition equation or factors in a multiplication equation to be moved or placed in a different order while solving.
- **Associative property** allows for addends in addition equations or factors in multiplication equations to be grouped together into different pairs while solving.
- **Identity property** allows for 0 to be added or 1 to be multiplied by any number and the number remains the same.
- **Inverse property** allows a number to be added to the opposite number for a sum of 0. Also, a number multiplied by the reciprocal fraction has a product of 1. (EE.2)

The square or cubed root of a number can be a **rational** or an **irrational number**. In the case of irrational numbers, use the **radical** or **cubed root symbol** in the solution to the equation. For example, $x = \sqrt{2}$. The value of the square or cubed root can also be approximated to the nearest rational number. (EE.2)

Rational number: a ratio of two integers that can be written as a repeating or terminating decimal. (EE.2)

Irrational number: a number that cannot be written as the ratio of two integers and is a nonrepeating and nonterminating decimal. (EE.2)

Important Tip

✍ The value cubed is the inverse operation of the cubed root, and a value squared is the inverse operation of a square root.

Sample Items 7–10**Item 7****Selected-Response**

Jenna wants to hang outdoor stringed lights on her house along the roof line and horizontally across, connecting the ends of the roof line to create a triangle.

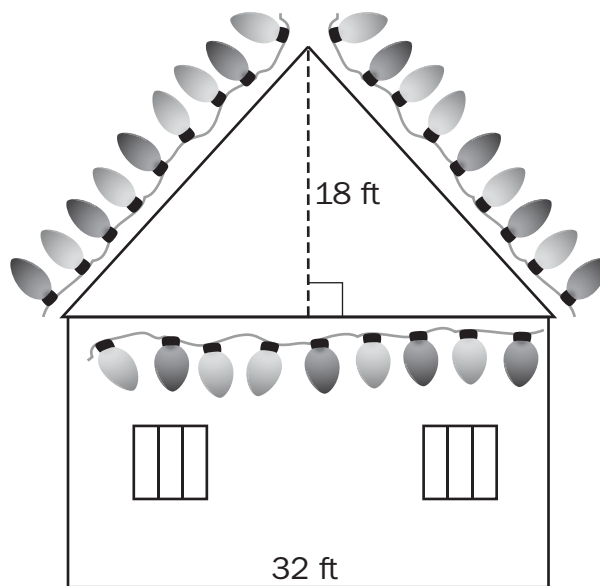

What is the approximate total length, in feet, of lights that she needs to create one triangle?

- A. 48 feet
- B. 64 feet
- C. 80 feet
- D. 98 feet

Item 8

Selected-Response

For a classroom party, there are 12 bottles of fruit punch. Each bottle is filled with 850 cubic centimeters of punch. The fruit punch will be served in cone-shaped paper cups that are 7 centimeters across and 12 centimeters tall.

How many completely full cone-shaped cups of the punch can be poured?

- A. 16
- B. 66
- C. 232
- D. 265

Item 9

Selected-Response

Look at the right triangle on the coordinate grid.

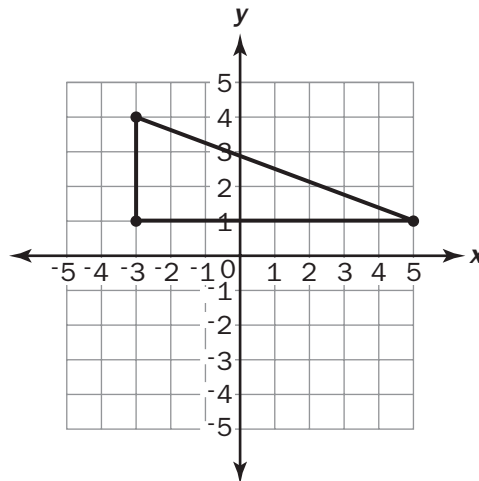

What is the length of the hypotenuse?

- A. $\sqrt{11}$ units
- B. $\sqrt{24}$ units
- C. $\sqrt{55}$ units
- D. $\sqrt{73}$ units

Item 10**Multi-Part Technology-Enhanced**

The coordinate grid shows right triangle ABC and point D .

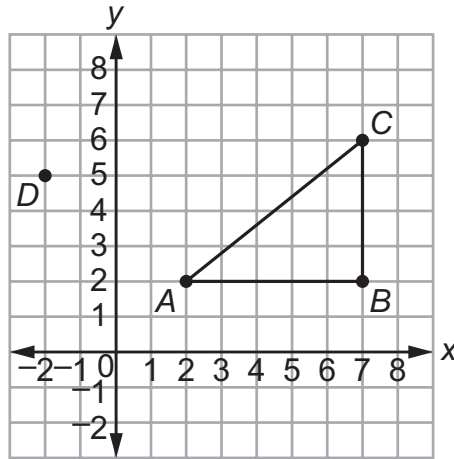
**Part A**

What is the distance, in units, from point A to point C ?

- A. 3
- B. $\sqrt{18}$
- C. $\sqrt{41}$
- D. 9

Part B

What is the distance, in units, from point A to point D ?

- A. $\sqrt{7}$
- B. $\sqrt{14}$
- C. 5
- D. 7

Unit 4: Functions

In this unit, you will work with functions. Functions produce input and output values. You can also graph functions. Functions can be represented numerically, graphically, verbally, and algebraically.

KEY TERMS

Function: A relationship between two sets of numbers, where one input value has only one output value. (F.1)

A function can be graphed using the input values as the x -coordinates and the output values as the y -coordinates. The **graph of the function** includes all points on the coordinate plane that make the function true. (F.1)

A function produces one **output** value for one **input** value. A **counterexample** can show an equation where one value can be input and produce two values as output. These counterexamples are not functions. (F.1)

Domain: The set of all x -coordinates in the ordered pairs that represent a relationship between numbers. This represents the input or **independent** value. (F.1)

Range: The set of all y -coordinates in the ordered pairs that represent a relationship between numbers. This represents the output or **dependent** value. (F.1)

Functions can be represented in four ways:

- **Numerically:** A function can be represented as numbers in an input/output table.
- **Graphically:** A function can be graphed on the coordinate plane using ordered pairs: (input, output).
- **Verbally:** The relationship between numbers in a function can be written in words.
- **Algebraically:** A function can be written as an equation involving variables. (F.2)

Compare the properties of two different functions written in any form to find which function has a greater **rate of change**. (F.2)

Important Tip

- ✍ When listing the domain and range of a relation, list each x -coordinate value for the domain without duplicating numbers. List each y -coordinate value for the range without duplicating numbers. In a list that contains a repeated domain value that is paired with more than one range value, the relation is not a function. This is true because the input, or x -coordinate value, has produced more than one output, or y -coordinate value.

Sample Items 11–13

Item 11

Selected-Response

Which of these functions has a greater rate of change than the function $y = 5.6x + 7$?

A.

x	y
-1	-10
0	-4
1	2
2	8

B. $y = \frac{7}{3}x - 2$

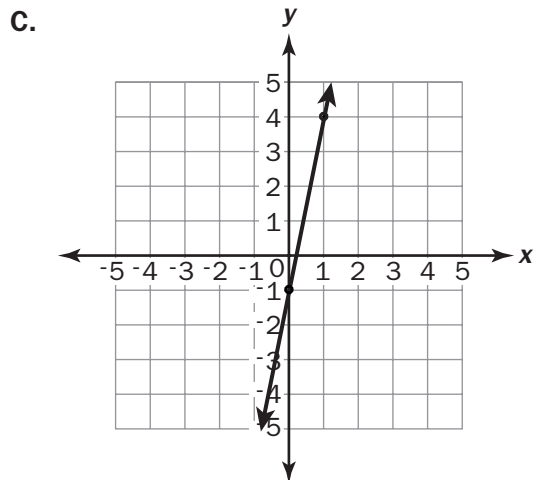

D. $y = -4x + 10$

Unit 5: Linear Functions

In this unit, you will work with ratios, slope, graphs, and linear functions. You will compare two proportional relationships using the unit rate as the slope. You will compare proportional relationships and determine the rate of change.

KEY TERMS

Proportional relationship: A relationship between two ratios that are equivalent. (EE.5)

Slope: The steepness of a line, also the **unit rate** in proportional relationships. (EE.5)

Graph proportional relationships on the **coordinate plane** using the **unit rate** as the slope. (EE.5)

Compare two proportional relationships that are written in different **forms**, including graphed on the coordinate plane or written as an equation. Determine the proportional relationship that has the greater **rate of change**. (EE.5)

Slope can be determined using any two points on a **straight line** by finding the **ratio** between the **vertical rise** of the line and the **horizontal run** of the line. For example, a line that passes through (0, 0) and (4, 1) has a vertical rise of 1 and a horizontal run of 4, so the slope of the line is $\frac{1}{4}$. (EE.6)

A **straight line** continues at the same steepness, or **slope**, through its entire length. The measure of the slope is the same between any two points on the line. (EE.6)

The **slope** of the side lengths will remain the same between **similar triangles**. This can be proven using the endpoints of corresponding sides to determine and compare the slopes. (EE.6)

Linear function: A function that produces a straight line when graphed on the coordinate plane. The linear function can be written as an equation in slope-intercept form.

- **$y = mx$:** the slope-intercept form of a line going through the origin, where m represents the slope.
- **$y = mx + b$:** the slope-intercept form of a line that crosses the y -axis at b , where m represents the slope. (F.3)

Important Tips

- ✍ A straight line on a coordinate plane can be vertical, horizontal, or diagonal.
- ✍ The slope of a line can be determined using any two points on the line by writing the ratio of the vertical rise to the horizontal run. The ratio written as a fraction can then be reduced to represent the slope if necessary. For example, a line going through the points (1, 2) and (9, 6) has a slope of $\frac{4}{8}$, which can be reduced to $\frac{1}{2}$.

Sample Items 14–17**Item 14****Selected-Response**

Which equation represents a nonlinear function?

A. $y = 3x^3$

B. $3x + 2y = 10$

C. $y = 15.3$

D. $y = \frac{1}{4}x - 2$

Item 15

Constructed-Response

Look at $\triangle ABC$ with coordinates $A(-1, -1)$, $B(2, 3)$, and $C(2, -1)$.

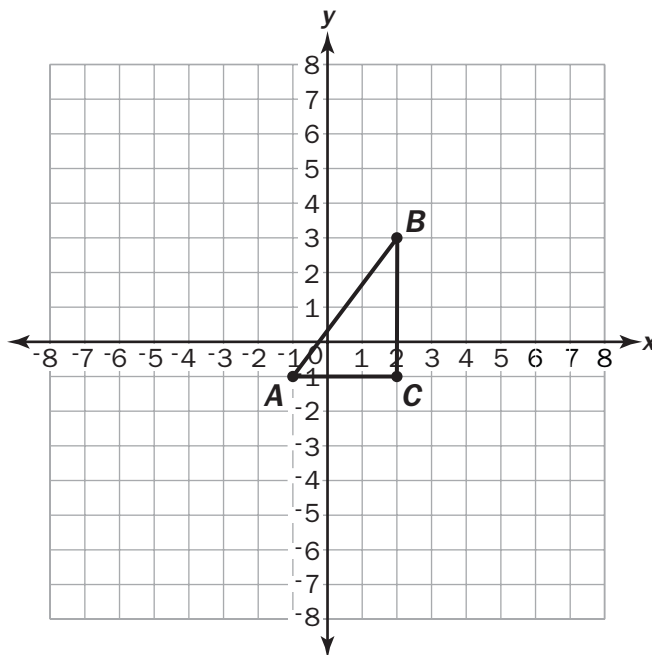

Part A: The ordered pair $(5, y)$ defines the location of point F , which is on line AB . What is the value of y for this ordered pair?

Part B: If you move 3 units to the right from point F , how many units up or down do you need to move in order to stay on line AB ?

Item 16**Selected-Response**

Consider this graph that passes through points (0, 0) and (5, 30).

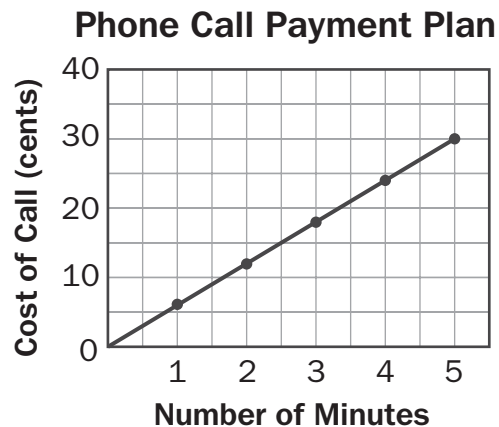

Which equation represents the cost of a phone call c after m minutes, according to the payment plan?

- A. $c = \frac{1}{6}m$
- B. $c = 6m$
- C. $c = \frac{1}{30}m$
- D. $c = 30m$

Item 17**Multi-Select Technology-Enhanced**

Select **THREE** equations whose graphs are straight lines.

- A. $y = 7$
- B. $y = \frac{1}{x}$
- C. $y = \frac{1}{2}x$
- D. $3x + y = 10$
- E. $y = x^2 - 2$
- F. $x^2 + y^2 = 1$

Unit 6: Linear Models and Tables

In this unit, you will work with models that are linear functions, the slope, qualitative and quantitative variables, data, and scatter plots. You will also identify the rate of change from tables, graphs, equations, or verbal description. You will describe patterns using bivariate data using different methods, including clustering, associations, and outliers. You will draw a line of best fit and use tables.

KEY TERMS

Rate of change: The ratio used to describe the change in the input and output values within a function. (F.4)

Model a linear relationship between values as a **linear function**. Determine the **rate of change**, or **slope**, based on a description of the linear relationship and a starting point (x, y) . Use this information to **graph** the linear function on the coordinate plane. (F.4)

Qualitative variable: A variable with a value that is not numerical—for instance, color, type of animal, or other variable in data collection that is described verbally. (F.5)

Quantitative variable: A variable with a value that is numerical—for instance, length, temperature, or other variable in data collection that is described numerically. (SP.2)

Bivariate data: Two response variables from data collection within the same population. For example, height and weight of dogs, with the height being an independent variable and the weight being a dependent variable related to the height. (SP.1)

Scatter plot: A graph placing a point for each **ordered pair** representing the bivariate data. Conclusions about a **data set** can be drawn using the visual representation of the scatter plot to look for relationships between values. (SP.1)

Describe **patterns** in bivariate data using:

- **Clustering:** breaking a data set into smaller groups that share a common trait or similarity.
- **Outliers:** pieces of data that stand out from the rest of the data set.
- **Positive association:** data that increase together; the data points rise from the lower left side to the upper right side of the graph.
- **Negative association:** data with one variable that increases while the other variable decreases; the data points fall from the upper left side to the lower right side of the graph.
- **Linear association:** a relationship that is represented using a straight line, such as a linear function.
- **Nonlinear association:** a relationship that is not represented by a straight line. (SP.1)

Line of best fit: A straight line drawn on a scatter plot that passes through the center of the group of data points. (SP.2)

Bivariate data can be used to create **graphs** and **linear equations** based on the slope and intercept of the line. (SP.3)

A **two-way table** can be used to represent bivariate data, including the **frequencies** of data occurring. Use the two-way table to identify **positive** or **negative association** between variables. (SP.4)

Important Tips

- ✍ A pattern in the data set can be used to predict the outcomes of other variables.
- ✍ The relationship between values can be represented using tables, graphs, and equations using the slope and y-intercept.

Sample Items 18–21

Item 18

Constructed-Response

This table of values represents a linear function.

x	y
0	80
4	60
8	40
12	20

Part A: Is the rate of change of this function -5 ? Explain how you know.

Part B: What is the initial value of this function?

Item 19

Selected-Response

Look at the scatter plot showing the relationship between the average daily temperature and the number of visitors at a beach.

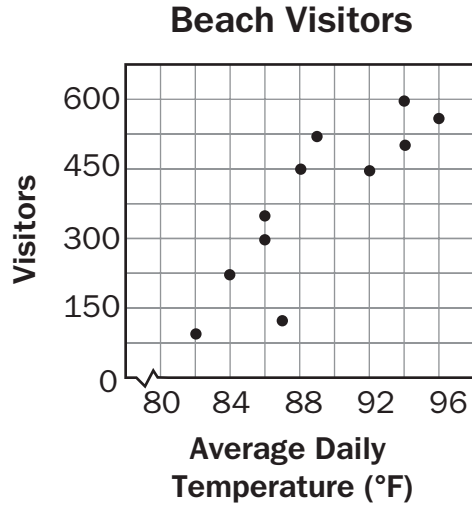

What is the pattern of association shown by the data?

- A. no association
- B. positive association
- C. negative association
- D. nonlinear association

Item 20

Selected-Response

Which straight line BEST fits the data for the scatter plot?

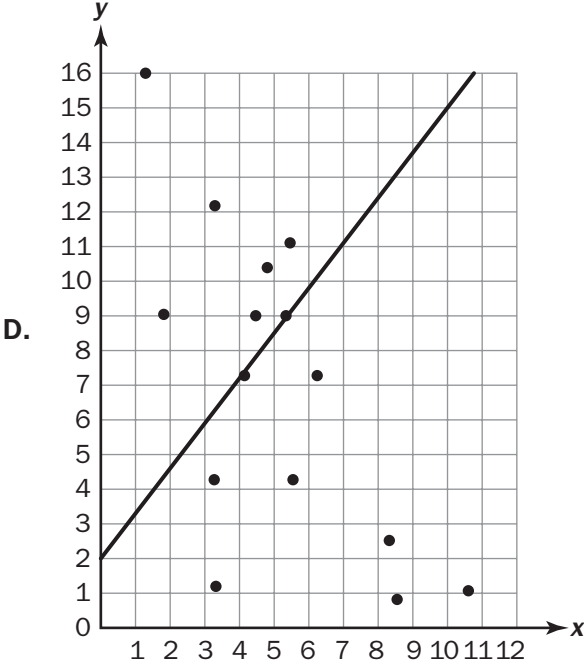
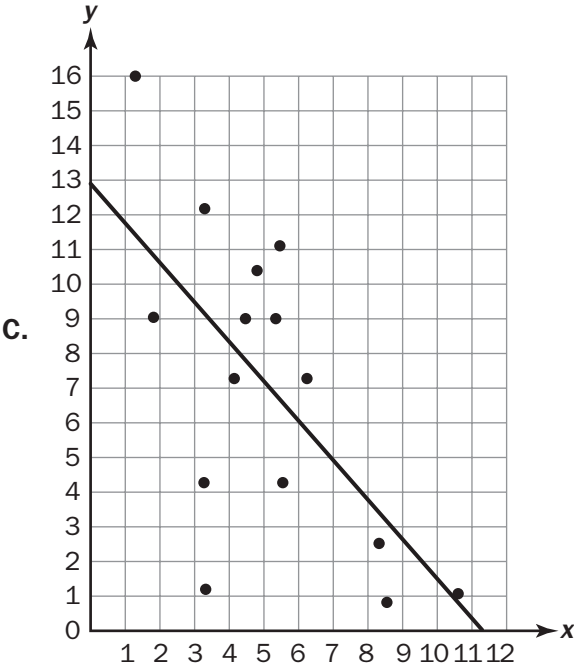
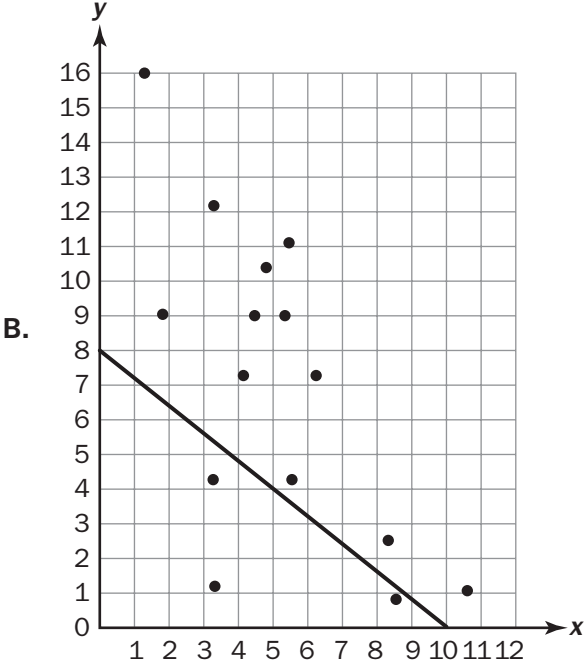
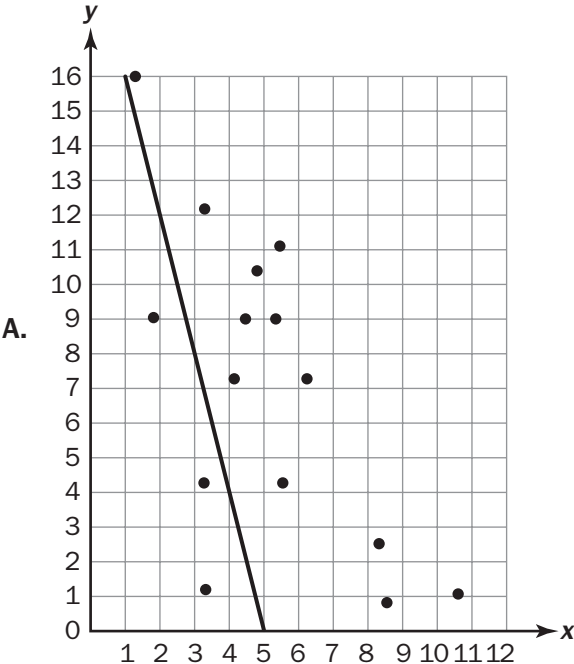

Item 21**Multi-Part Technology-Enhanced**

The two-way table shows some survey results from when 100 Georgia residents were asked whether they were born in Georgia.

Georgia Residents

	Born in Georgia	Not Born in Georgia	Total
Female			66
Male	16		
Total		47	

There are values missing from the two-way table. You will need to determine the missing values from the two-way table.

Part A

How many of the males surveyed were not born in Georgia?

- A. 16
- B. 18
- C. 29
- D. 34

Part B

Select **TWO** statements that are true about the data.

- A. There were more males born in Georgia than there were females born in Georgia.
- B. More than half of all residents surveyed were born in Georgia.
- C. More males were born in Georgia than were not born in Georgia.
- D. More females were not born in Georgia than were born in Georgia.
- E. There were more females not born in Georgia than there were males not born in Georgia.

Unit 7: Solving Systems of Equations

In this unit, you will work with systems of equations to define relationships between variables. You will find the solutions to systems of equations. You will learn about parallel, co-linear, and intersecting lines and about how to solve systems of equations algebraically.

KEY TERMS

System of equations: Multiple equations that work together to define the relationship between variables. (EE.8a)

The **solution** to a system of equations can be represented by graphing the line of solutions for each equation. The point or points where the lines **intersect** on the **coordinate plane** show the valid solutions to all of the equations in the system. (EE.8a)

Parallel lines: Two lines that have the same slope and do not intersect. A system of equations that produces two parallel lines has no solution. (EE.8b)

Collinear lines: Two lines that share all of the same points. A system of equations that produces two co-linear lines has an infinite number of solutions. (EE.8b)

Systems of equations can also be solved **algebraically** by completing the operations on each side of the equation using the **addition property of equality** and **multiplication property of equality**. (EE.8b)

Addition property of equality: Adding the same number or value to both sides of an equation results in equivalent equations. (EE.8b)

Multiplication property of equality: Multiplying the same number or value to both sides of an equation results in equivalent equations. (EE.8b)

Use systems of equations in **real-world situations** by determining the solution or set of solutions that will satisfy a set of equations. A solution can also be determined based on **sets of points**. Given two sets of points, draw the corresponding line for each set and identify any locations where the lines intersect. (EE.8c)

Important Tip

 The number of solutions to a system of equations can be no solution, one solution, or multiple solutions, including an infinite number of solutions.

Sample Items 22–24

Item 22

Selected-Response

Consider this system of equations.

$$\begin{aligned} -7x + 8y &= 1 \\ 4x - 8y &= 20 \end{aligned}$$

What is the y -coordinate of the solution for this system?

- A. -1
- B. -6
- C. 1
- D. 6

Item 23

Selected-Response

Consider this system of equations.

$$y = -2x - 1$$

$$y = \frac{1}{2}x + 4$$

Which graph represents the solution of the system?

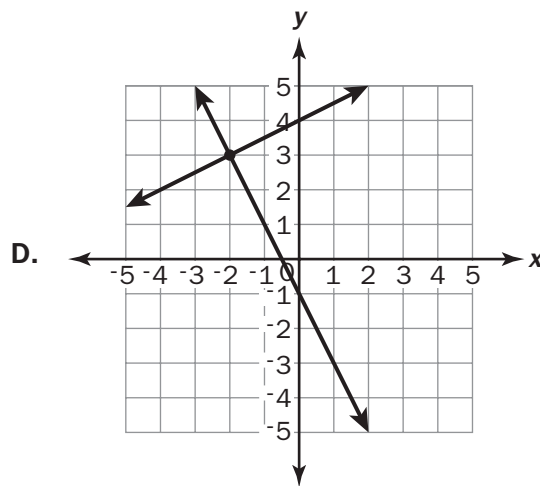
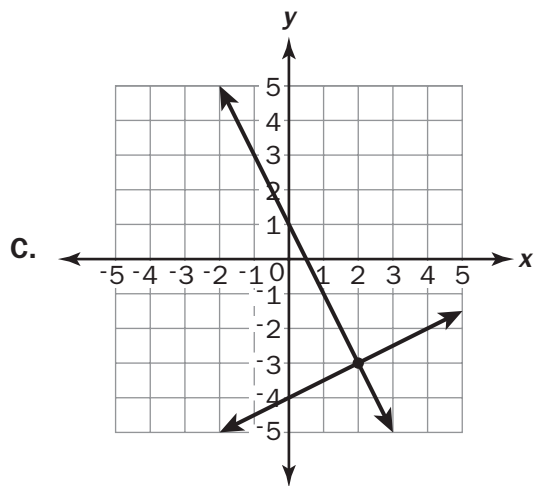
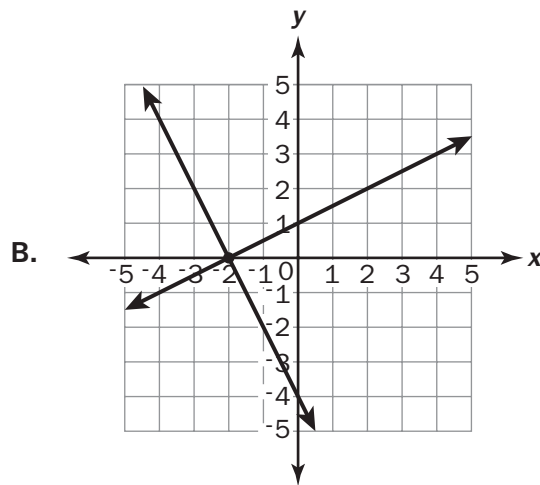
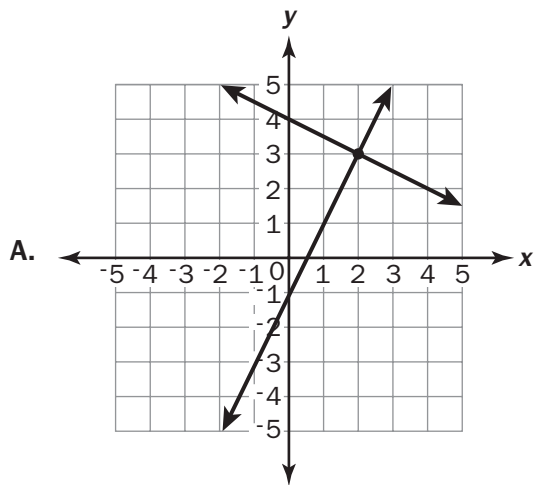

Item 24

Selected-Response

Which system of equations has exactly one solution?

- A. $5x - y = -3$
 $5x - y = -2$
- B. $8x - 3y = -12$
 $x - 3y = 9$
- C. $3x - y = 4$
 $9x - 3y = 12$
- D. $2x - y = 3$
 $2x - y = -4$

MATHEMATICS ADDITIONAL SAMPLE ITEM KEYS

Item	Standard/ Element	DOK Level	Correct Answer	Explanation
1	MGSE8.G.1	2	C	The correct answer is choice (C) because the before and after segments have the same x -coordinates and opposite y -coordinates. Choice (A) is incorrect because the before and after segments are congruent, while a dilation by a factor of $\frac{1}{2}$ would make the after segment half the length of the before segment. Choice (B) is incorrect because rotation would not result in the vertices having the same x -coordinates. Choice (D) is incorrect because the line segment was translated 6 units down, but it was not translated 1 unit to the left.
2	MGSE8.G.3	3	N/A	See scoring rubric beginning on page 114 and sample response on page 115.
3	MGSE.8.G3	2	C	The correct answer is choice (C) because it follows the correct sequence of transformations. Choice (A) is incorrect because it is translated and only the right endpoint is reflected. Choice (B) is incorrect because it is reflected without the translation. Choice (D) is incorrect because it is reflected first and then translated.
4	MGSE8.N.S.2	2	B	The correct answer is choice (B) because 21 falls between 16 and 25, the perfect squares of 4 and 5. Choice (A) is incorrect because it does not show understanding that the number is not a fractional value. Choice (C) is incorrect because the square of all the values in this range is greater than 21. Choice (D) is incorrect because it is the result of dividing 21 by 2.
5	MGSE8.EE.3	1	D	The correct answer is choice (D). The exponents are subtracted because these two numbers are being divided. Choice (A) is incorrect because the exponents are multiplied together. Choice (B) is incorrect because the exponents are divided. Choice (C) is incorrect because the exponents are added together.
6	MGSE8.EE.1	2	N/A	See scoring rubric on page 116 and sample response on page 117.
7	MGSE8.G.8	2	C	The correct answer is choice (C) because each slanted side length = $\sqrt{18^2 + 16^2} \approx 24$. So the perimeter of the triangle $\approx 24 + 24 + 32 = 80$ ft. Choice (A) is incorrect because only the slants of the roof are calculated, without including the horizontal distance. Choice (B) is incorrect because the slants of the roof are calculated without doubling the horizontal distance to cover both right triangles. Choice (D) is incorrect because the height of the triangle is included in the total length.

Item	Standard/ Element	DOK Level	Correct Answer	Explanation
8	MGSE8.G.9	2	B	The correct answer is choice (B) because the volume of each cup is $\frac{1}{3} \pi (3.5)^2(12) \approx 154$ cm. There is a total of $12.850 = 10,200$ cm ³ of punch. So $10,200 \div 154 \approx 66$ cups can be filled. Choice (A) is incorrect because the diameter was mistakenly used. Choice (C) is incorrect because the radius was not squared in the calculations. Choice (D) is incorrect because half the radius was mistakenly used in the formula.
9	MGSE8.G.8	2	D	The correct answer is choice (D) because the length of the hypotenuse = $\sqrt{8^2 + 3^2} = \sqrt{73}$. Choice (A) is incorrect because the legs were not squared before finding the hypotenuse value. Choice (B) is incorrect because it is the square root of the product of two legs. Choice (C) is incorrect because the squares of the leg values are subtracted instead of added.
10	GSE-1: 8.G.8	2	Part A: C Part B: C	See scoring rubric on page 117.
11	MGSE8.F.2	2	A	The correct answer is choice (A) because it has the greatest rate of change, which is 6. Choice (B) is incorrect because the rate of change is 2.3. Choice (C) is incorrect because the rate of change is 5. Choice (D) is incorrect because it has the rate of change as -4 .
12	MGSE8.F.1	2	N/A	See scoring rubric and sample response on page 118.
13	MGSE8.F.2	2	N/A	See scoring rubric and sample response on page 119.
14	MGSE8.F.3	1	A	The correct answer is choice (A) because the exponent of 3 causes the graph to be a curve. Choice (B) is a straight line when graphed. Choice (C) is a straight line when graphed. Choice (D) is a straight line when graphed.
15	MGSE8.EE.6	2	N/A	See scoring rubric and sample response on page 120.
16	MGSE8.EE.6	2	B	The correct answer choice is (B) because every minute costs 6 cents. Choice (A) is incorrect because the line was interpreted with the x-value read before the y-value. Choice (C) is incorrect because the slope was misinterpreted to have a rise of 1 and a run of 30. Choice (D) is incorrect because, though there is a point with the rise of 30, the run was not interpreted.
17	GSE-1: 8.F.3	2	A/C/D	See scoring rubric on page 121.
18	MGSE8.F.4	2	N/A	See scoring rubric and sample response on page 122.

Item	Standard/ Element	DOK Level	Correct Answer	Explanation
19	MGSE8.SP.1	1	B	The correct answer choice is (B) because the scatter plot shows the warmer the temperatures the more visitors there are. Choice (A) is incorrect because there is an association because the dots are clustered together near a line of best fit. Choice (C) is incorrect because a negative association would mean that as the temperature gets warmer, the number of visitors goes down. Choice (D) is incorrect because the points seem to follow a linear pattern.
20	MGSE8.SP.2	2	C	The correct answer is choice (C) because the points are distributed evenly above and below the line. Choice (A) and choice (B) are not correct because, though they show a negative slope with a line of best fit, the points are not distributed equally above and below the line of best fit. Choice (D) is incorrect because the line of best fit shows a positive slope that does not match the pattern of the data points.
21	GSE-1: 8.SP.4	3	Part A: B Part B: B/E	See scoring rubric on page 123.
22	MGSE8.EE.8b	2	B	The correct answer is choice (B) because -6 is the y -coordinate of the point that makes both equations true. Choice (A) is incorrect because the rules for integer operations were not followed, though the steps were performed correctly. Choice (C) is incorrect because the integer sign rules were not followed initially, but the steps thereafter are correct. Choice (D) is incorrect because the integer rules were not followed.
23	MGSE8.EE.8a	2	D	The correct answer is choice (D) because the solution to both the system of equations and the graph is $(-2, 3)$. Choice (A) is incorrect because the graph has correct y -intercepts but incorrect slopes. Choice (B) is incorrect because the graph has incorrect slopes but correct y -intercepts. Choice (C) is incorrect because the y -intercepts are incorrect, though the graph has the correct slopes.
24	MGSE8.EE.8b	2	B	The correct answer is choice (B) because the solution is $(-3, -4)$. Choice (A), choice (C), and choice (D) are all systems with no solution or infinitely many solutions.

MATHEMATICS SAMPLE SCORING RUBRICS AND EXEMPLAR RESPONSES

Item 2

Scoring Rubric

Points	Description
4	<p>The response achieves the following:</p> <ul style="list-style-type: none"> • The response demonstrates a complete understanding of applying a sequence of transformations to obtain a similar figure. • Give 4 points for four parts answered correctly. <ul style="list-style-type: none"> • Response is correct and complete. • Response shows application of a reasonable and relevant strategy. • Mathematical ideas are expressed coherently through a clear, complete, logical, and fully developed response using words, calculations, and/or symbols, as appropriate.
3	<p>The response achieves the following:</p> <ul style="list-style-type: none"> • The response demonstrates a nearly complete understanding of applying a sequence of transformations to obtain a similar figure. • Give 3 points for three parts answered correctly OR for correct answers for four parts but no explanation given for either Part C or Part D. <ul style="list-style-type: none"> • Response is mostly correct but contains either a computational error or an unclear or incomplete explanation. • Response shows application of a relevant strategy, though it may be only partially applied or remain unexplained. • Mathematical ideas are expressed only partially using words, calculations, and/or symbols, as appropriate.
2	<p>The response achieves the following:</p> <ul style="list-style-type: none"> • The response demonstrates a partial understanding of applying a sequence of transformations to obtain a similar figure. • Give 2 points for two parts answered correctly OR for correct answers for four parts but no explanations given for both Part C and Part D. <ul style="list-style-type: none"> • Response is only partially correct. • Response shows application of a relevant strategy, though it may be only partially applied or remain unexplained. • Mathematical ideas are expressed only partially using words, calculations, and/or symbols, as appropriate.

Points	Description
1	<p>The response achieves the following:</p> <ul style="list-style-type: none"> • The response demonstrates a minimal understanding of applying a sequence of transformations to obtain a similar figure. • Give 1 point for one part answered correctly. <ul style="list-style-type: none"> • Response is only partially correct. • Response shows incomplete or inaccurate application of a relevant strategy. • Mathematical ideas are expressed only partially using words, calculations, and/or symbols, as appropriate.
0	<p>The response achieves the following:</p> <ul style="list-style-type: none"> • The response demonstrates limited to no understanding of applying a sequence of transformations to obtain a similar figure. <ul style="list-style-type: none"> • Response is incorrect. • Response shows no application of a strategy. • Mathematical ideas cannot be interpreted or lack sufficient evidence to support even a limited understanding.

Exemplar Response

Points Awarded	Sample Response
4	<p>Part A: Figure is translated 1 unit up and 4 units to the right. Part B: Figure is translated 4 units to the right and 2 units down. Part C: Figure is dilated by a scale factor of 2. Part D: Yes. You could translate the quadrilateral $A'B'C'D'$ first (by different amounts) and then dilate it by 2. <i>Or other valid explanation</i></p>
3	The student correctly answers three out of the four parts.
2	The student correctly answers two out of the four parts.
1	The student correctly answers one of the four parts.
0	<i>Response is irrelevant, inappropriate, or not provided.</i>

Item 6

Scoring Rubric

Points	Description
2	<p>The response achieves the following:</p> <ul style="list-style-type: none"> • Response demonstrates a complete understanding of applying properties of integer exponents to perform operations. • Give 2 points for Part A correct AND Part B correct. <ul style="list-style-type: none"> • Response is correct and complete. • Response shows application of a reasonable and relevant strategy. • Mathematical ideas are expressed coherently through a clear, complete, logical, and fully developed response using words, calculations, and/or symbols, as appropriate.
1	<p>The response achieves the following:</p> <ul style="list-style-type: none"> • Response demonstrates a partial understanding of applying properties of integer exponents to perform operations. • Give 1 point for Part A OR Part B correct. <ul style="list-style-type: none"> • Response is mostly correct but contains either a computational error or an unclear or incomplete explanation. • Response shows application of a relevant strategy, though it may be only partially applied or remain unexplained. • Mathematical ideas are expressed only partially using words, calculations, and/or symbols, as appropriate.
0	<p>The response achieves the following:</p> <ul style="list-style-type: none"> • The response demonstrates limited to no understanding of applying properties of integer exponents to perform operations. <ul style="list-style-type: none"> • Response is incorrect. • Response shows no application of a strategy. • Mathematical ideas cannot be interpreted or lack sufficient evidence to support even a limited understanding.

Exemplar Response

Points Awarded	Sample Response
2	Part A: 343 or 7^3 or equivalent Part B: I found the answer by adding the exponents because the two factors have the same base. The result is 7 to the third power, which equals 343.
1	Part A: 6 Part B: By adding them together
0	<i>Response is irrelevant, inappropriate, or not provided.</i>

Item 10

Scoring Rubric

Points	Description
2	The response achieves the following: <ul style="list-style-type: none"> A score of 2 indicates complete understanding of how to apply the Pythagorean Theorem to find the distance between two points in a coordinate system. The student determines that the correct answer for Part A is Choice (C). AND <ul style="list-style-type: none"> The student determines that the correct answer for Part B is Choice (C).
1	The response achieves the following: <ul style="list-style-type: none"> A score of 1 indicates a partial understanding of how to apply the Pythagorean Theorem to find the distance between two points in a coordinate system. The student determines that the correct answer for Part A is Choice (C). OR <ul style="list-style-type: none"> The student determines that the correct answer for Part B is Choice (C).
0	The response achieves the following: <ul style="list-style-type: none"> A score of 0 indicates limited to no understanding of how to apply the Pythagorean Theorem to find the distance between two points in a coordinate system.

Item 12

Scoring Rubric

Points	Description
2	<p>The response achieves the following:</p> <ul style="list-style-type: none"> • Response demonstrates a complete understanding of functions as the set of ordered pairs consisting of an input and the corresponding output. • Give 2 points for Part A correct AND Part B correct. <ul style="list-style-type: none"> • Response is correct and complete. • Response shows application of a reasonable and relevant strategy. • Mathematical ideas are expressed coherently through a clear, complete, logical, and fully developed response using words, calculations, and/or symbols, as appropriate.
1	<p>The response achieves the following:</p> <ul style="list-style-type: none"> • Response demonstrates a partial understanding of functions as the set of ordered pairs consisting of an input and the corresponding output. • Give 1 point for Part A OR Part B correct. <ul style="list-style-type: none"> • Response is mostly correct but contains either a computational error or an unclear or incomplete explanation. • Response shows application of a relevant strategy, though it may be only partially applied or remain unexplained. • Mathematical ideas are expressed only partially using words, calculations, and/or symbols, as appropriate.
0	<p>The response achieves the following:</p> <ul style="list-style-type: none"> • The response demonstrates limited to no understanding of functions as a set of ordered pairs consisting of an input and corresponding output. <ul style="list-style-type: none"> • Response is incorrect. • Response shows no application of a strategy. • Mathematical ideas cannot be interpreted or lack sufficient evidence to support even a limited understanding.

Exemplar Response

Points Awarded	Sample Response
2	<p>Part A: Table D Part B: It is not a function because the same value of x has two different output values and a function can have only one unique output for every input.</p>
1	<p>Part A: Table D Part B: It is not a function.</p>
0	<p><i>Response is irrelevant, inappropriate, or not provided.</i></p>

Item 13

Scoring Rubric

Points	Description
2	<p>The response achieves the following:</p> <ul style="list-style-type: none"> Response demonstrates a complete understanding of comparing properties of two functions represented in different ways. Give 2 points for Part A correct AND Part B correct. <ul style="list-style-type: none"> Response is correct and complete. Response shows application of a reasonable and relevant strategy. Mathematical ideas are expressed coherently through a clear, complete, logical, and fully developed response using words, calculations, and/or symbols, as appropriate.
1	<p>The response achieves the following:</p> <ul style="list-style-type: none"> Response demonstrates a partial understanding of comparing properties of two functions represented in different ways. Give 1 point for Part A OR Part B correct. <ul style="list-style-type: none"> Response is mostly correct but contains either a computational error or an unclear or incomplete explanation. Response shows application of a relevant strategy, though it may be only partially applied or remain unexplained. Mathematical ideas are expressed only partially using words, calculations, and/or symbols, as appropriate.
0	<p>The response achieves the following:</p> <ul style="list-style-type: none"> The response demonstrates limited to no understanding of comparing properties of two functions represented in different ways. <ul style="list-style-type: none"> Response is incorrect. Response shows no application of a strategy. Mathematical ideas cannot be interpreted or lack sufficient evidence to support even a limited understanding.

Exemplar Response

Points Awarded	Sample Response
2	<p>Part A: The equation represents the function with the greater rate of change.</p> <p>Part B: The rate of change for the table is 3. I know because as the value of x increases by 1, the value of y increases by 3. The rate of change for the equation is 5. I know because the equation is in slope-intercept form and the slope, m, is 5. Since 5 is greater than 3, the equation has the greater rate of change.</p>
1	<p>Part A: The equation represents the function with the greater rate of change.</p> <p>Part B: I know because the initial value of the equation is greater than the initial value for the table.</p>
0	<i>Response is irrelevant, inappropriate, or not provided.</i>

Item 15

Scoring Rubric

Points	Description
2	<p>The response achieves the following:</p> <ul style="list-style-type: none"> • Response demonstrates a complete understanding of using similar triangles to define the slope between any two points and writing an equation of the line using the slope. • Give 2 points for Part A correct AND Part B correct. <ul style="list-style-type: none"> • Response is correct and complete. • Response shows application of a reasonable and relevant strategy. • Mathematical ideas are expressed coherently through a clear, complete, logical, and fully developed response using words, calculations, and/or symbols, as appropriate.
1	<p>The response achieves the following:</p> <ul style="list-style-type: none"> • Response demonstrates a partial understanding of using similar triangles to define slope between any two points and writing an equation of the line using the slope. • Give 1 point for Part A OR Part B correct. <ul style="list-style-type: none"> • Response is mostly correct but contains either a computational error or an unclear or incomplete explanation. • Response shows application of a relevant strategy, though it may be only partially applied or remain unexplained. • Mathematical ideas are expressed only partially using words, calculations, and/or symbols, as appropriate.
0	<p>The response achieves the following:</p> <ul style="list-style-type: none"> • The response demonstrates limited to no understanding of using similar triangles to define slope between any two points and writing an equation of the line using the slope. <ul style="list-style-type: none"> • Response is incorrect. • Response shows no application of a strategy. • Mathematical ideas cannot be interpreted or lack sufficient evidence to support even a limited understanding.

Exemplar Response

Points Awarded	Sample Response
2	<p>Part A: 7 Part B: You must move 4 units up.</p>
1	<p>Part A: 7 Part B: You must move 1 unit up.</p>
0	<p><i>Response is irrelevant, inappropriate, or not provided.</i></p>

Item 17

Scoring Rubric

Points	Description
2	<p>The response achieves the following:</p> <ul style="list-style-type: none"> • A score of 2 indicates complete understanding of how to interpret the equation $y = mx + b$ as defining a linear function, whose graph is a straight line; give examples of functions that are not linear. • The student selects Choice (A), Choice (C), and Choice (D).
1	<p>The response achieves the following:</p> <ul style="list-style-type: none"> • A score of 1 indicates a partial understanding of how to interpret the equation $y = mx + b$ as defining a linear function, whose graph is a straight line; give examples of functions that are not linear. • The student selects Choice (A) and Choice (C), with or without an additional incorrect answer. OR • The student selects Choice (A) and Choice (D), with or without an additional incorrect answer. OR • The student selects Choice (C) and Choice (D), with or without an additional incorrect answer.
0	<p>The response achieves the following:</p> <ul style="list-style-type: none"> • A score of 0 indicates limited to no understanding of how to interpret the equation $y = mx + b$ as defining a linear function, whose graph is a straight line; give examples of functions that are not linear. • The student selects Choice (A), with or without any additional incorrect answers. OR • The student selects Choice (C), with or without any additional incorrect answers. OR • The student selects Choice (D), with or without any additional incorrect answers. OR • The student does not select any correct answers.

Item 18

Scoring Rubric

Points	Description
2	<p>The response achieves the following:</p> <ul style="list-style-type: none"> • Response demonstrates a complete understanding of determining the rate of change and initial value of a function. • Give 2 points for Part A correct AND Part B correct. <ul style="list-style-type: none"> • Response is correct and complete. • Response shows application of a reasonable and relevant strategy. • Mathematical ideas are expressed coherently through a clear, complete, logical, and fully developed response using words, calculations, and/or symbols, as appropriate.
1	<p>The response achieves the following:</p> <ul style="list-style-type: none"> • Response demonstrates a partial understanding of determining rate of change and initial value of a function. • Give 1 point for Part A OR Part B correct. <ul style="list-style-type: none"> • Response is mostly correct but contains either a computational error or an unclear or incomplete explanation. • Response shows application of a relevant strategy, though it may be only partially applied or remain unexplained. • Mathematical ideas are expressed only partially using words, calculations, and/or symbols, as appropriate.
0	<p>The response achieves the following:</p> <ul style="list-style-type: none"> • The response demonstrates limited to no understanding of determining rate of change and initial value of a function. <ul style="list-style-type: none"> • Response is incorrect. • Response shows no application of a strategy. • Mathematical ideas cannot be interpreted or lack sufficient evidence to support even a limited understanding.

Exemplar Response

Points Awarded	Sample Response
2	<p>Part A: Yes, that is the correct rate of change. I know because as x increases by 1, y decreases by 5. Part B: 80</p>
1	<p>Part A: Yes, that is the correct rate of change. I know because as x increases by 1, y decreases by 5. Part B: 0</p>
0	<p><i>Response is irrelevant, inappropriate, or not provided.</i></p>

Item 21

Scoring Rubric

Points	Description
2	<p>The response achieves the following:</p> <ul style="list-style-type: none"> • A score of 2 indicates complete understanding that patterns of association can also be seen in bivariate categorical data by displaying frequencies and relative frequencies in a two-way table. • The student determines that the correct answer for Part A is Choice (B). AND • The student determines that the correct answers for Part B are Choice (B) and Choice (E).
1	<p>The response achieves the following:</p> <ul style="list-style-type: none"> • A score of 1 indicates a partial understanding that patterns of association can also be seen in bivariate categorical data by displaying frequencies and relative frequencies in a two-way table. • The student determines that the correct answer for Part A is Choice (B). OR • The student determines that the correct answers for Part B are Choice (B) and Choice (E).
0	<p>The response achieves the following:</p> <ul style="list-style-type: none"> • A score of 0 indicates limited to no understanding that patterns of association can also be seen in bivariate categorical data by displaying frequencies and relative frequencies in a two-way table.

SCIENCE

DESCRIPTION OF TEST FORMAT AND ORGANIZATION

The Grade 8 Science EOG assessment has a total of 76 items.

The test will be given in two sections.

- You may have up to 70 minutes per section to complete Sections 1 and 2.
- The total estimated testing time for the Grade 8 Science EOG assessment ranges from approximately 90 to 140 minutes.

CONTENT

The Grade 8 Science EOG assessment will measure the Grade 8 Science standards that are described at www.georgiastandards.org. The Science Georgia Standards of Excellence are designed to provide foundational knowledge and skills for all students to develop proficiency in science. These standards focus on a limited number of core disciplinary ideas and crosscutting concepts which build from kindergarten to high school. The standards are written with the core knowledge to be mastered integrated with the science and engineering practices needed to engage in scientific inquiry and engineering design. Crosscutting concepts are used to make connections across different science disciplines.

The content of the assessment covers standards that are reported under these domains:

- Matter
- Energy
- Motion
- Waves
- Force

ITEM TYPES

Operational items in the Science portion of the Grade 8 EOG assessment consist of selected-response (multiple-choice) and technology-enhanced (multiple-select or two-part) items.

SCIENCE DEPTH OF KNOWLEDGE EXAMPLE ITEMS

Example items that represent applicable DOK levels of the Science assessment are provided for you on the following pages. The items and explanations of what is expected of you to answer them will help you prepare for the test.

All example and sample items contained in this guide are the property of the Georgia Department of Education.

Example Item 1

Selected-Response

DOK Level 1: This is a DOK level 1 item because the question requires the student to recall information concerning a known relationship between scientific quantities.

Science Grade 8 Content Domain: Matter

Standard: S8P1. Obtain, evaluate, and communicate information about the structure and properties of matter.

- b. Develop and use models to describe the movement of particles in solids, liquids, gases, and plasma states when thermal energy is added or removed.

Look at the illustrations.

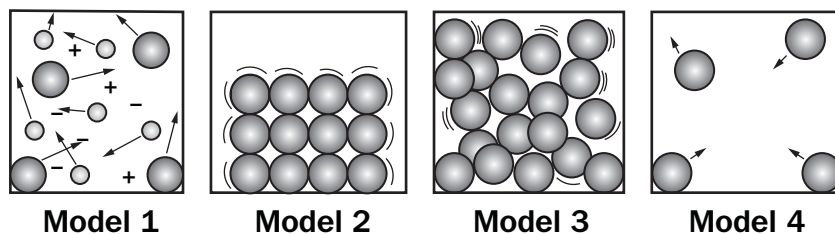

Which model shows the structure and movement of particles in a solid?

- A. model 1
- B. model 2
- C. model 3
- D. model 4

Correct Answer: B

Explanation of Correct Answer: The correct answer is choice (B) model 2. Model 2 shows particles that are held in a fixed position. Choice (A) is incorrect because model 1 shows plasma. The particles in plasma move more freely and have electrical charges. Choice (C) is incorrect because model 3 shows a liquid. Particles in a liquid are more randomly distributed and move more freely than those in a solid. Choice (D) is incorrect because model 4 shows a gas. Particles in a gas are spread far apart and move randomly.

Example Item 2

Selected-Response

DOK Level 2: This is a DOK level 2 item because the question requires the student to apply learned information to abstract and real-life situations.

Science Grade 8 Content Domain: Force

Standard: S8P5. Obtain, evaluate, and communicate information about gravity, electricity, and magnetism as major forces acting in nature.

- a. Plan and carry out investigations to identify the factors (e.g., distance between objects, magnetic force produced by an electromagnet with varying number of wire turns, varying number or size of drycells, and varying size of iron core) that affect the strength of electric and magnetic forces.

(*Clarification statement:* Including, but not limited to, generators or motors.)

A group of students is investigating the different factors that affect the strength of an electric motor. A diagram of the motor is shown.

Inner Workings of an Electric Motor

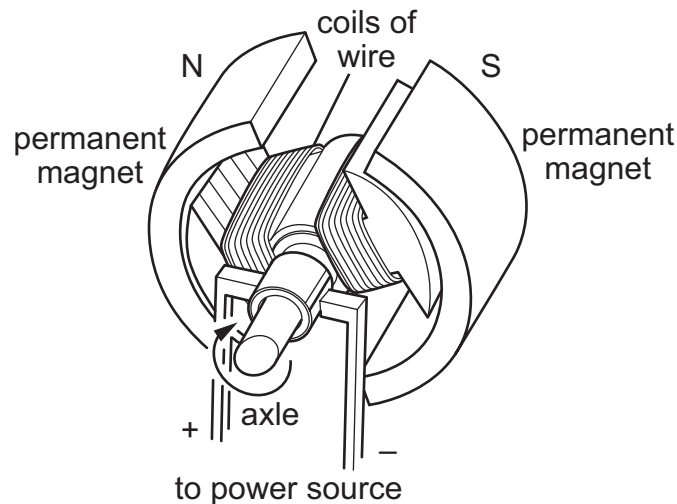

What step should the students take next in the investigation to increase the strength of the motor?

- A. Reduce the size of the axle running through the center of the motor.
- B. Increase the number of coils of wire within the two sections of the motor.
- C. Decrease the voltage of the power source being used to operate the motor.
- D. Place the permanent magnets and coils of wire farther apart inside the motor.

Correct Answer: B

Explanation of Correct Answer: The correct answer is choice (B) Increase the number of coils of wire within the two sections of the motor. Increasing the number of coils of wire makes each loop of the coil closer to the other coils. This makes the magnetic fields from each coil overlap more, so their strengths add up. This makes the total magnetic field of both parts of the motor stronger, which makes the motor stronger. Choice (A) is incorrect because reducing the size of the axle might allow the motor to spin faster, but it will not increase the strength of the motor. Choice (C) is incorrect because a decrease in the battery voltage will cause less current and result in less strength for the motor. Choice (D) is incorrect because moving the magnets and coils farther apart will reduce the magnetic field strength and strength for the motor.

Example Item 3

Selected-Response

DOK Level 3: This is a DOK level 3 item because the question requires the student to construct arguments supported by evidence, to analyze and interpret data, to construct explanations and design solutions, and to plan and carry out investigations.

Science Grade 8 Content Domain: Motion

Standard: S8P3. Obtain, evaluate, and communicate information about cause and effect relationships between force, mass, and the motion of objects.

b. Construct an explanation using Newton's Laws of Motion to describe the effects of balanced and unbalanced forces on the motion of an object.

A force diagram of a tennis ball flying through the air toward the right is shown in the diagram below. The arrows show the direction of the gravitational force (F_{grav}), the drag force (F_{drag}), the lift force (F_{lift}), and the direction of movement of the tennis ball.

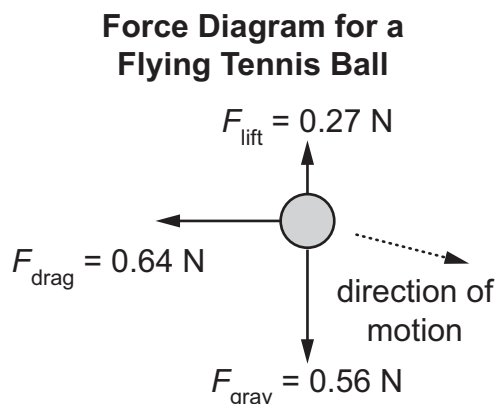

Which pair of statements is a valid description and explanation of the motion of the ball based on evidence from the diagram?

- A. description:** The ball slows down as it moves to the right because the horizontal forces are unbalanced, with the larger force acting to the left.
explanation: The ball speeds up as it moves downward because the vertical forces are unbalanced, with the larger force acting downward.
- B. description:** The ball speeds up as it moves to the right because the horizontal forces are unbalanced, with the larger force acting to the right.
explanation: The ball speeds up as it moves downward because the vertical forces are unbalanced, with the larger force acting downward.
- C. description:** The ball moves at a constant speed to the right because the horizontal forces are unbalanced, with the larger force acting to the left.
explanation: The ball slows down as it moves downward because the vertical forces are unbalanced, with the larger force acting upward.
- D. description:** The ball slows down as it moves to the right because the horizontal forces are unbalanced, with the larger force acting to the right.
explanation: The ball moves at a constant speed downward because the vertical forces are unbalanced, with the larger force acting upward.

Correct Answer: A

Explanation of Correct Answer: The correct answer is choice (A)

description: The ball slows down as it moves to the right because the horizontal forces are unbalanced, with the larger force acting to the left.

explanation: The ball speeds up as it moves downward because the vertical forces are unbalanced, with the larger force acting downward.

Choice (B) is incorrect because, while the horizontal force is unbalanced, the net force is to the left, not to the right, so the ball slows down as it moves to the right. Choice (C) is incorrect because the ball speeds up while moving downward because the unbalanced vertical forces produce a large downward force.

Choice (D) is incorrect because the net horizontal force is to the left, and the ball is speeding up as it moves downward.

SCIENCE CONTENT DESCRIPTION AND ADDITIONAL SAMPLE ITEMS

In this section, you will find information about what to study in order to prepare for the Grade 8 Science EOG assessment. This includes main ideas and important concepts. This section also contains practice questions with an explanation of the correct answers that you can use to prepare for the test.

All example and sample items contained in this guide are the property of the Georgia Department of Education.

CONTENT DESCRIPTION

- Develop an understanding of the structure and properties of matter.
- Investigate the law of conservation of energy.
- Investigate the cause-and-effect relationships between force, mass, and the motion of objects.
- Compare and contrast the energy and behavior of electromagnetic (light) waves and mechanical (sound waves).
- Investigate the major forces acting in nature of gravity, electricity, and magnetism.

Force

This section will focus on developing a conceptual understanding of the relationship between force, mass, and the motion of objects; and energy transformations. You will develop an understanding that all objects and substances in the natural world are composed of matter that is influenced by forces. You will explore the relationship between velocity and acceleration through graphical representations of the motion of objects. You will gain a qualitative understanding of the universal laws of motion through scenarios in which forces act through direct physical contact between objects as well as examples in which forces act on objects at a distance (via gravitational force).

KEY CONCEPTS

Displacement is the length and direction of a straight line between two locations, or positions. Since displacement considers only the length and direction of a straight line, it doesn't depend on the actual path of a moving object. If Town A is 10 miles east of Town B, the displacement of Town A is 10 miles east relative to Town B. For a moving object, displacement can be defined as the change between the initial and final position of the object. (S8P3a)

Distance is a measure of the length of a path that a moving object travels. If the only road between the two towns has to wind through hills, the distance traveled between the two towns is longer than 10 miles, even though the displacement between the two towns is 10 miles east. (S8P3a)

Velocity is a quantity that measures the rate at which the position of an object changes in time. Velocity always describes a distance and a direction. Since velocity has direction, one way to show this numerically is to assume that travelling in a certain direction is symbolized with positive numbers while traveling opposite that direction is shown using negative numbers. (S8P3a)

Speed measures the rate at which an object moves along a path. Unlike velocity, speed is not considered to have a direction. (S8P3a)

Acceleration is a quantity that measures the rate at which an object changes its velocity. People often talk about an object decelerating when the object slows down. An object that slows down is actually experiencing a negative acceleration. This means the rate of change is a negative value. An object can have a velocity but not acceleration if it is moving at a constant velocity. For example, a car takes one hour to make a trip of 80 kilometers on a straight road pointing due east. In the middle of the trip, the car accelerated to 100 kilometers per hour (kph) and operated at that speed for 10 minutes and then accelerated to 60 kph and operated at that speed for 10 minutes. After the first acceleration the speed of the car was 100 kph, and during that time, the velocity of the car was 100 kph eastward. After the second acceleration the speed of the car was 60 kph and the velocity of the car during that time was 60 kph eastward. Finally, the car accelerated again back to 80 kph. The average velocity of the car over the whole trip was 80 kph eastward, and the average speed was 80 kph. (S8P3a)

A **force** is a push or pull on an object. Force can be the result of contact, such as when you push a book across your desk. Forces between objects that are not in contact with each other can be explained by the presence of force fields, like the magnetic field and the gravitational field. When one magnet repels another magnet, there is a push force that acts on the magnets even though the magnets are not in contact. (S8P3b)

When two or more forces act on an object but the object's velocity does not change, the object is being acted on by **balanced forces**. A book on your desk that is not moving is said to be **stationary**. The book is said to be at **rest** in relation to the desk. Gravity is acting to pull the book down. The desk pushes up against the book, and the book is at rest in relation to the desk. (S8P3b)

An accelerating object is being acted on by **unbalanced forces**. When you push your book across your desk, you are applying force to one side of the book. The force of friction acts on the book in the opposite direction that the book is moving, reducing the speed at which the book moves. Because the book begins to move in the direction you are pushing it, these forces are unbalanced. (S8P3b)

Friction is the force that resists motion between two surfaces. (S8P3b)

Inertia is the resistance to any change in the state of motion of any physical object. All matter has inertia, and the inertia of matter does not change until the matter is acted on by unbalanced forces that cause a change in motion. (S8P3b)

Mass is the total amount of matter of an object. Mass is a numerical measure of the object's inertia. The mass of an object does not change, regardless of where the object is located. (S8P3c)

Gravity is the force of attraction that exists between any two or more masses. Gravity can refer to the force that Earth exerts on everything. (S8P3b, S8P5a)

Important Tip

✍ When thinking of energy transforming from one form to another, remember that, in most cases, it is not a matter of one form of energy being transformed into only one other form of energy. When you rub your hands together, the kinetic energy of your hands is transformed by friction into heat energy. You can also hear your hands rubbing together, which is the result of the friction converting some of the kinetic energy into sound energy. (S8P2c)

Sample Items 1–3

Item 1

Selected-Response

A coach at a track meet measured the time of a runner every 10 meters (m) during a 100 m dash. The data for the runner are shown.

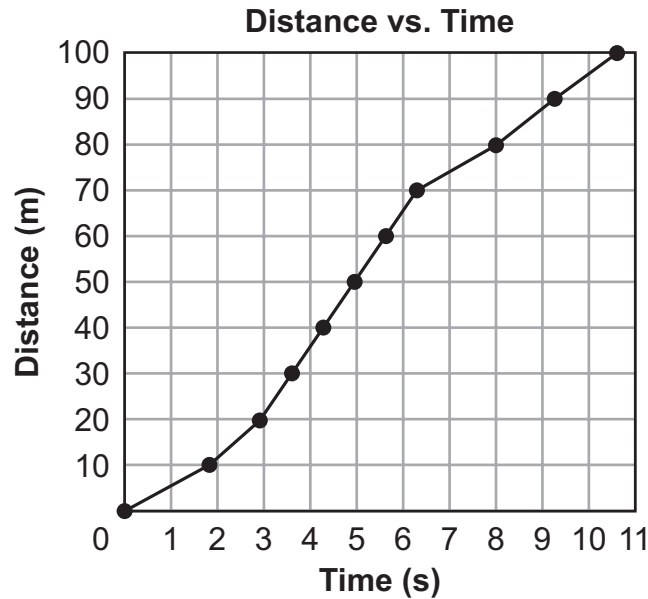

Which statement is the BEST analysis of the data for the runner?

- A. The runner covers the first 80 m running at a constant speed and then slows down, reaching a minimum speed during the final 20 m.
- B. The runner starts slower and speeds up, reaching a constant speed between 20 and 80 m, and then speeds up again during the final 20 m.
- C. The runner covers the first 70 m running at a constant speed and then speeds up, reaching a maximum speed during the final 30 m.
- D. The runner starts slower and speeds up, reaching a maximum speed between 50 and 70 m, and then slows down during the final 30 m.

Item 2**Selected-Response**

A force diagram for a downhill skier is shown.

Force Diagram for Downhill Skier

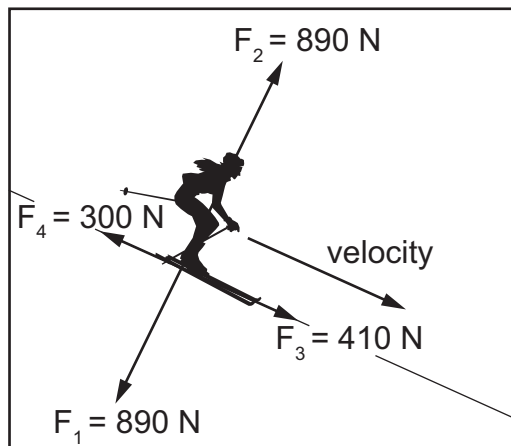

Which statement is a valid description and explanation of the skier's motion based on evidence from the diagram?

- A. The skier's speed decreases going down the hill because forces F_1 and F_2 are balanced and acting perpendicular to the direction of the velocity, causing the skier to speed up.
- B. The skier's speed increases going down the hill because forces F_1 and F_2 are balanced and acting perpendicular to the direction of the velocity causing the skier to slow down.
- C. The skier's speed increases going down the hill because forces F_3 and F_4 are unbalanced, with F_3 acting in the same direction as the velocity, causing the skier to speed up.
- D. The skier's speed decreases going down the hill because forces F_3 and F_4 are unbalanced, with F_4 acting in the opposite direction of the velocity, causing the skier to slow down.

Item 3**Selected-Response**

During a shot put event, athletes throw a very heavy round ball, called a shot, as far as possible. The graph shows the vertical velocity of a shot that was thrown by an athlete.

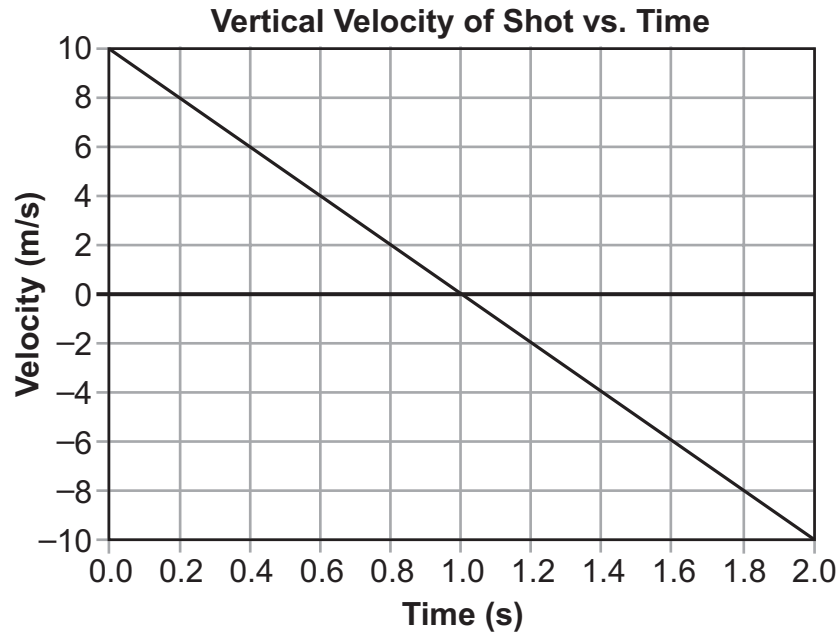

Which statement is an accurate analysis of the vertical motion of the shot?

- A. The direction of the velocity is upward for both the first second and the last second, and the acceleration remains constant for the entire period.
- B. The direction of the velocity is downward for both the first second and the last second, and the acceleration decreases during the entire period.
- C. The direction of the velocity is upward for the first second and then downward for the last second, and the acceleration decreases during the entire period.
- D. The direction of the velocity is upward for the first second and then downward for the last second, and the acceleration remains constant for the entire period.

Structure and Properties of Matter

In this section, you will develop a conceptual understanding of the nature of matter. You will understand that, in a chemical reaction, matter can be neither created nor destroyed, only transformed. You will learn about the characteristics of matter (i.e., physical and chemical properties) that are useful to classify and differentiate substances.

KEY CONCEPTS

Atoms are the smallest unit of matter that defines the chemical element. **Elements** are pure chemical substances that are made up of one type of atom. A **molecule** is made of two or more atoms joined together chemically. Molecules can be made of the same element or more than one element. Water molecules are made up of two atoms of hydrogen and one atom of oxygen. (S8P1a, e)

The **Periodic Table of Elements** is a table arranging all the known elements into groups with common properties. This arrangement also demonstrates trends based on those properties. (S8P1e)

Periodic Table of Elements

1 1 H Hydrogen																	2 2 He Helium																	
3 Li Lithium	4 Be Beryllium											5 B Boron	6 C Carbon	7 N Nitrogen	8 O Oxygen	9 F Fluorine	10 Ne Neon																	
11 Na Sodium	12 Mg Magnesium											13 Al Aluminum	14 Si Silicon	15 P Phosphorus	16 S Sulfur	17 Cl Chlorine	18 Ar Argon																	
19 K Potassium	20 Ca Calcium	21 Sc Scandium	22 Ti Titanium	23 V Vanadium	24 Cr Chromium	25 Mn Manganese	26 Fe Iron	27 Co Cobalt	28 Ni Nickel	29 Cu Copper	30 Zn Zinc	31 Ga Gallium	32 Ge Germanium	33 As Arsenic	34 Se Selenium	35 Br Bromine	36 Kr Krypton																	
37 Rb Rubidium	38 Sr Strontium	39 Y Yttrium	40 Zr Zirconium	41 Nb Niobium	42 Mo Molybdenum	43 Tc Technetium	44 Ru Ruthenium	45 Rh Rhodium	46 Pd Palladium	47 Ag Silver	48 Cd Cadmium	49 In Indium	50 Sn Tin	51 Sb Antimony	52 Te Tellurium	53 I Iodine	54 Xe Xenon																	
55 Cs Cesium	56 Ba Barium											72 Hf Hafnium	73 Ta Tantalum	74 W Tungsten	75 Re Rhenium	76 Os Osmium	77 Ir Iridium	78 Pt Platinum	79 Au Gold	80 Hg Mercury	81 Tl Thallium	82 Pb Lead	83 Bi Bismuth	84 Po Polonium	85 At Astatine	86 Rn Radon								
87 Fr Francium	88 Ra Radium											104 Rf Rutherfordium	105 Db Dubnium	106 Sg Seaborgium	107 Bh Bohrium	108 Hs Hassium	109 Mt Meitnerium	110 Ds Darmstadtium	111 Rg Roentgenium	112 Cn Copernicium	113 Uut Ununtrium	114 Fl Flerovium	115 Uup Ununpentium	116 Lv Livermorium	117 Uus Ununseptium	118 Uuo Ununoctium								
																		57 La Lanthanum	58 Ce Cerium	59 Pr Praseodymium	60 Nd Neodymium	61 Pm Promethium	62 Sm Samarium	63 Eu Europium	64 Gd Gadolinium	65 Tb Terbium	66 Dy Dysprosium	67 Ho Holmium	68 Er Erbium	69 Tm Thulium	70 Yb Ytterbium	71 Lu Lutetium		
																		89 Ac Actinium	90 Th Thorium	91 Pa Protactinium	92 U Uranium	93 Np Neptunium	94 Pu Plutonium	95 Am Americium	96 Cm Curium	97 Bk Berkelium	98 Cf Californium	99 Es Einsteinium	100 Fm Fermium	101 Md Mendelevium	102 No Nobelium	103 Lr Lawrencium		

Substance is matter of any form that cannot be broken down into separate elements by physical means but can be broken down using chemical changes. (S8P1a)

A **compound** is a pure chemical substance that is made up of two or more different elements. Salt is a compound whose molecules are made up of one atom of sodium and one atom of chlorine. (S8P1a)

A **mixture** is made of two or more substances that are not combined chemically. Salted popcorn is an example of a mixture. (S8P1a)

Matter is anything that has mass and occupies space. Matter can be found in several states (e.g., solid, liquid, gas, plasma). (S8P1b, c)

Physical properties are any properties that are measurable and can be observed. Physical properties can be determined without changing the chemical properties of an object. Color, hardness, area, length, strength, temperature, and state of matter are some examples of physical properties. (S8P1c)

The **states of matter** are the different forms that matter can be found in. Water is a **liquid**, the state of matter that has a definite volume but no fixed shape. When water is ice, it is a **solid**. Solids have a definite shape and volume. Their shape and volume cannot be easily changed. When water is steam, or water vapor, it is a **gas**. Gases have no definite shape and take the shape of their container. **Plasma** is gas that is charged. Plasma conducts electricity easily. Stars and neon lights are examples of plasma. Plasma is different from the other states of matter in that it is a high-energy state of matter. (S8P1b)

Mass is the total amount of matter of an object. Mass is a numerical measure of the object's inertia. The mass of an object does not change regardless of where the object is located. (S8P3c)

Volume is the amount of space that an object or substance occupies. Volume is a physical property. (S8P1b)

Density is the physical property that describes how tightly matter is put together. A pure element, such as gold, will have a characteristic density and mass. (S8P1c)

Boiling point is the physical property that describes the temperature at which a substance will change from a liquid to a gas. Water boils at 100°C (212°F). (S8P1c)

Melting point is the physical property that describes the temperature at which a solid will become a liquid. Ice, a solid, will change into liquid water at 0°C (32°F). This is the melting point of water. (S8P1c)

Chemical properties are any properties that can be measured only by chemically changing an object. Paper starts to burn at around 249°C (480°F). At this temperature the paper combines with oxygen in the air and new substances are formed. (S8P1c)

Combustibility is the chemical property of how easily a substance will set on fire. For example, paper's heat of combustion is around 249 degrees Celsius. (S8P1c)

Reactivity is the chemical property of the capacity of an atom or molecule to go through a chemical reaction with another atom or molecule. Sodium is a very reactive metal. Sodium reacts rapidly and energetically with other substances. Gold is a metal that is not very reactive. It won't tarnish from oxygen or water. (S8P1c)

A **physical change** happens when matter has a change in its physical properties but not its chemical properties. For example, salt can be dissolved in water, but if the water evaporates, the salt is still there. (S8P1d)

A **chemical change** happens when matter breaks down into two or more substances or when more than one substance is combined to form a new substance. Hydrogen peroxide forming bubbles on its own is an example of matter breaking down into two substances. Vinegar and baking soda turning into bubbling foam is an example of two substances combining to create other substances. (S8P1d)

A **chemical reaction** is a process where two or more substances combine chemically in some way to form one or more other substances. When iron is combined with air and water, the iron is slowly converted into rust. (S8P1f)

A **precipitate** is a solid that is formed by a chemical reaction. Precipitates can form in a solution or inside another solid. (S8P1d)

The **law of conservation of matter** states that the total amount of matter in a system cannot be created or destroyed. When a piece of paper burns, it becomes ash, water vapor, and carbon dioxide. If the mass of the ash, water vapor, and carbon dioxide were found, it would be the same as the mass of the paper before the paper was burnt. (S8P1f)

Important Tip

✍ The movement of particles within the different states of matter can vary greatly. Particles in solids are packed together very tightly, and they do not move around easily. This is why solids tend to be hard. Particles in a liquid move around and are packed loosely. Particles in gases move in all sorts of directions, and the particles are spread very far apart. (S8P1b)

Sample Items 4–7

Item 4

Selected-Response

A student is planning an investigation to explore different properties of matter.

Which investigation will help the student explore a physical property of matter?

- A. **investigation:** Place a solid in a beaker and add a small amount of liquid.
observation: The beaker becomes warm to the touch.
- B. **investigation:** Add a small amount of solid to a liquid in a beaker.
observation: The solid dissolves in the liquid.
- C. **investigation:** Add a small amount of solid to a liquid in a beaker.
observation: The solution starts to fizz and overflows the container.
- D. **investigation:** Place a solid in a beaker and add a small amount of liquid.
observation: Bubbles form on the top of the solid.

Item 5

Selected-Response

Iron can be found as a gray powder and sulfur can be found as a yellow powder. A student is shown models of two substances made of iron (Fe) and sulfur (S).

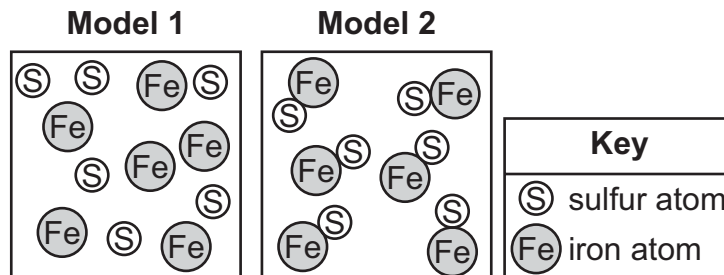

The student is asked to classify each substance as a mixture or a pure substance and describe how it would appear. Which classification and description of the models is correct?

A.

Model	Classification	Description
1	pure substance	uniform
2	homogeneous mixture	gray and yellow particles visible but evenly distributed

B.

Model	Classification	Description
1	pure substance	gray and yellow particles visible but evenly distributed
2	heterogeneous mixture	uniform

C.

Model	Classification	Description
1	homogeneous mixture	uniform
2	pure substance	gray and yellow particles visible but evenly distributed

D.

Model	Classification	Description
1	heterogeneous mixture	gray and yellow particles visible but evenly distributed
2	pure substance	uniform

Item 6

Multi-Part Technology-Enhanced

A student is shown a simple model of particles that make up a liquid, as shown.

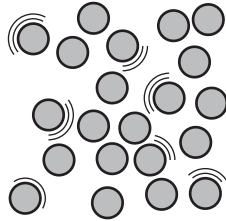

Part A

How should the model be changed to show the particles of a solid?

- A. Increase the velocities of the particles, and increase the space between the particles.
- B. Increase the velocities of the particles, and decrease the space between the particles.
- C. Decrease the velocities of the particles, and increase the space between the particles.
- D. Decrease the velocities of the particles, and decrease the space between the particles.

Part B

How should the model be changed to show the particles of a liquid at a higher temperature?

- A. Separate the particles into positive and negative charges, and increase the space between the particles.
- B. Separate the particles into positive and negative charges, but maintain the same space between the particles.
- C. Decrease the velocities of the particles, and decrease the space between the particles.
- D. Increase the velocities of the particles, but maintain the same space between the particles.

Item 7**Multi-Part Technology-Enhanced**

A student is asked to conduct an investigation that will determine a physical property of a cube-shaped solid block of salt sample.

Part A

Which procedure BEST measures a physical property of the sample?

- A.** 1. Measure 10 mL of vinegar (acetic acid) in a graduated cylinder.
2. Pour the acetic acid into a beaker.
3. Drop the sample into the beaker of acetic acid to determine what happens to the sample.
4. Record your observations.
- B.** 1. Gently break the solid sample into smaller pieces using a hammer.
2. Use long-handled forceps to pick up one of the small sample pieces.
3. Hold the small sample piece in the flame of a Bunsen burner for a few seconds to determine what happens to the sample.
4. Record your observations.
- C.** 1. Use a ruler to measure the length of one side of the sample.
2. Record this value to the nearest millimeter.
3. Cube the value in step 2.
4. Place the cubed sample on the digital balance.
5. Record this value to the nearest tenth of a gram.
6. Divide the value in step 5 by the value in step 3.
- D.** 1. Cut away two different-sized pieces of the sample and place into a container on a hot plate.
2. Place two thermometers in the containers, one touching each sample.
3. Record the time it takes the temperature of the smaller sample to increase 1°C.
4. Continue to heat the sample.
5. Record the time it takes the temperature of the larger sample to increase 1°C.
6. Subtract the value in step 3 from the value in step 5.

(The question continues on the next page.)

Part B

Which statement supports the answer to Part A?

- A. The physical property being tested is density; the procedure selected measures the mass and the volume of the sample.
- B. The physical property being tested is reactivity; the procedure selected determines whether the sample will change to a different substance due to mixing with acetic acid.
- C. The physical property being tested is melting point; the procedure selected measures the temperature at which the sample changes to a liquid.
- D. The physical property being tested is combustibility; the procedure selected determines whether the sample will begin to burn due to exposure to a flame.

Energy and Force

In this section, you will develop an understanding that energy exists in many forms. You will learn that in a closed system, energy can be transferred and transformed, but the total amount of energy available is always the same—it is conserved. You will also learn about two of the four main forces in the universe: gravitational and electromagnetic forces. You'll determine how these forces influence the motion of objects and are responsible for the work that a system does or for the work that is done on a system.

KEY CONCEPTS

The **law of conservation of energy** states that the total amount of energy in a system cannot change unless energy enters or leaves that system by some form and that energy cannot be created or destroyed. Energy can only change forms. An **energy transformation** refers to the changing of energy from one form to another. (S8P2b, c)

Gravitational potential energy is the energy stored in an object due to its position. The energy stored in a ball sitting at the top of a ramp is all potential energy. In the case of the ball, gravity is pulling down on the ball. Although the ball is not rolling down the hill, it has potential energy due to the pull of gravity. (S8P2a, b)

Kinetic energy is the energy of **motion**. As the ball starts to roll down the ramp, the potential energy of the ball transforms into kinetic energy. The energy in the system is converted from potential energy to kinetic energy. (S8P2a, b)

Mechanical energy is the total of all the potential energy and kinetic energy in an object. (S8P2b)

Thermal energy is the random motion of particles (whether vibrations in solids or molecules in free motion in a gas). This energy is distributed among all the particles in a system through collisions and interactions at a distance. Thermal energy flows from an object that has a higher temperature to one that has a lower temperature. (S8P2c, d)

Conduction is the movement of heat through an object or from one object to another when they are touching. In conduction, thermal energy is transferred between atoms when they collide with each other. Thermal energy moves from warmer areas, those with higher energy, to cooler areas, those with less energy. This is why ice in a glass of water melts on a warm day. Warm air molecules collide with the molecules of the glass container and transfer thermal energy to them. The molecules in the container then pass the thermal energy between themselves by direct contact. Finally, the energy is transferred to the water and ice by the water molecules coming in contact with both. The thermal energy flows toward the ice and the energy turns the ice into water. (S8P2d)

Convection is the movement of heat through fluids and gases. In convection, thermal energy is transferred due to differences in density caused by temperature variations. When you heat a pot of soup, the liquid becomes warm through convection. As the liquid at the bottom of the pot becomes warmer, its density decreases. The increased thermal energy causes the molecules to move faster, which spaces them farther apart, increasing the volume and thus decreasing the density. The change in density causes the warm liquid to rise to the top of the soup and the colder liquid to sink. It is this motion of the warm and cold masses that is called convection. (S8P2d)

Heat can also move by means of **radiation**. Thermal radiation does not require any form of matter to move through, as conduction and convection require. Thermal radiation energy moves via electromagnetic waves. Because of this, thermal radiation moves very fast. (S8P2d)

Electric energy is the energy of electrons moving through a conductor. Electricity is the name for the motion of electrons along the path formed by a conductor. (S8P2c)

Magnetic energy is produced when magnetic fields are generated. (S8P2c)

Gravity also refers to the **gravitational force** every object exerts on every other object. (S8P3b)

A **force** is a push or pull on an object. Force can be the result of contact, such as when you push a book across your desk. Forces between objects that are not in contact with each other can be explained by the presence of force fields, like the magnetic field and the gravitational field. When one magnet pushes another magnet, there is a force that acts on the magnets even though the magnets are not in contact. (S8P3b)

When two or more forces act on an object, but the object's velocity does not change, the object is being acted on by **balanced forces**. A book on your desk that is not moving is said to be **stationary**. The book is said to be at **rest** in relation to the desk. Gravity is acting to pull the book down. The desk pushes up against the book, and the book is at rest in relation to the desk. (S8P3b)

An accelerating object is being acted on by **unbalanced forces**. When you push your book across your desk, you are applying force to one side of the book. The force of friction acts on the book in the opposite direction that the book is moving, reducing the speed at which the book moves. Because the book begins to move in the direction you are pushing it, these forces are unbalanced. (S8P3b)

Magnetic materials have what are known as magnetic domains—they are sort of like pieces of a big puzzle, as shown in the illustration of magnetized material below. The two poles of a magnet result when these magnetic domains align in such a way that they point in the same direction. If you cut a magnet in half, the domains of each half will still line up so that the two new magnets each have a north pole and a south pole. In an object that is not magnetized, the domains lie in many different directions (as shown in the illustration below) and mostly cancel each other out. (S8P5a, c)

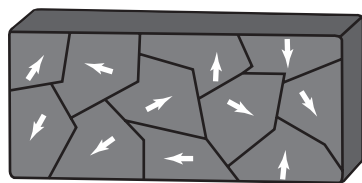

Not Magnetized

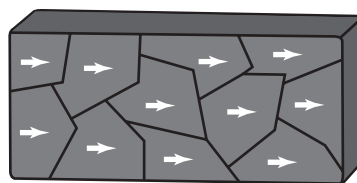

Magnetized

An **electromagnet** is created when a wire is coiled and an electric current flows through it. Generally, electromagnets have a metal core that helps to increase the strength of the electromagnet. Magnetic force is created by the movement of electrical charges through a wire. A magnetic field is created around the wire, and this magnetic field lines up the domains in the core, turning the core into a temporary magnet. When the electric current is turned off, the magnetic field quickly fades. An electromagnet can be made using a circuit with a battery, a switch, and wire wrapped around a nail. (S8P5c)

Sample Items 8–12**Item 8****Selected-Response**

A physics student used radar to measure the velocity of a vehicle over a 10-second period. The student presented the data in the graph shown.

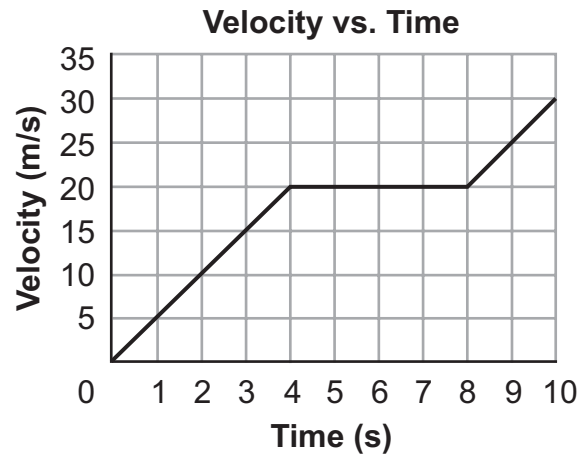

(Answer the question on the next page.)

Which graph of the kinetic energy of the vehicle versus time corresponds to the velocity versus time graph?

A. Kinetic Energy vs. Time

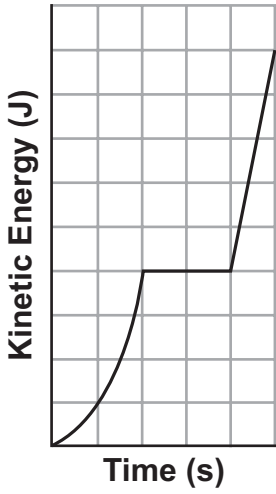

B. Kinetic Energy vs. Time

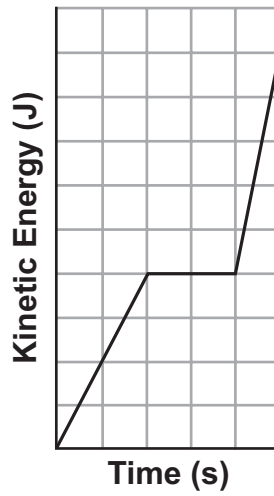

C. Kinetic Energy vs. Time

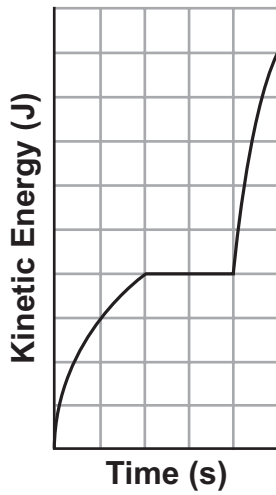

D. Kinetic Energy vs. Time

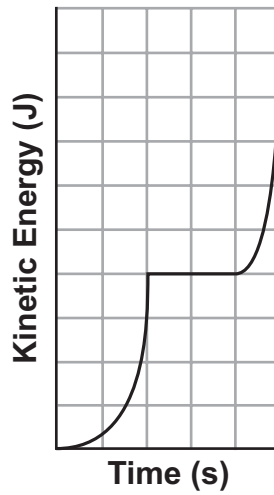

Item 9**Selected-Response**

A space agency tracked the path of an asteroid named 2011 MD, which passed within 12,300 kilometers of Earth's surface. The path of the asteroid is projected onto the plane of the moon's orbit around Earth in the diagram.

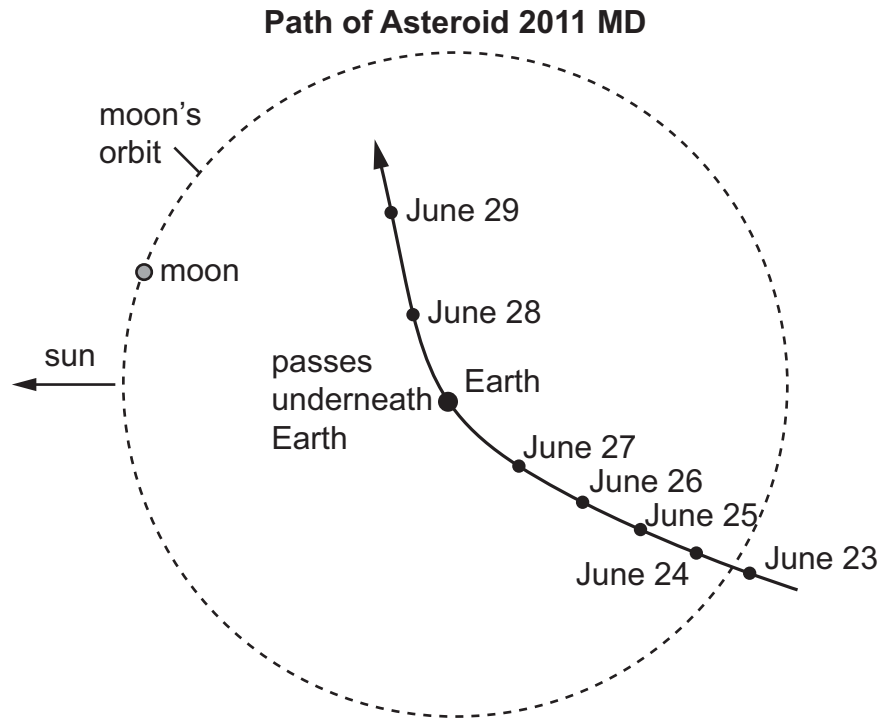

(Answer the question on the next page.)

Space scientists claimed that Earth's strong gravitational field was responsible for the path of asteroid 2011 MD. Which argument BEST supports this claim?

- A. The velocity of the asteroid changed as evidenced by the changing direction of the asteroid.
- B. The velocity of the asteroid changed as evidenced by the straight line path after it passes Earth.
- C. The position of the asteroid bends slightly away from Earth as evidenced by the different locations relative to Earth.
- D. The position of the asteroid bends slightly toward the sun as evidenced by the different locations relative to the sun.

Item 10

Selected-Response

A student is planning an investigation in which different modes of heat transfer will be used to heat a thermometer. The diagram shows the setup used to conduct the first part of the investigation.

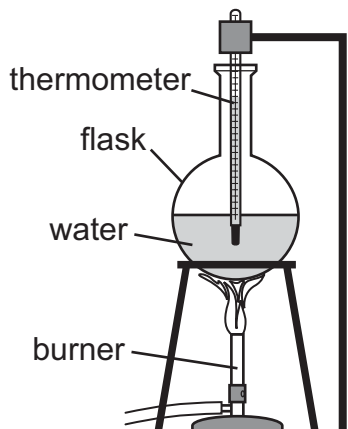

In this setup, the thermometer is being heated by conduction and convection. How should the student change the setup to heat the thermometer by using only radiation?

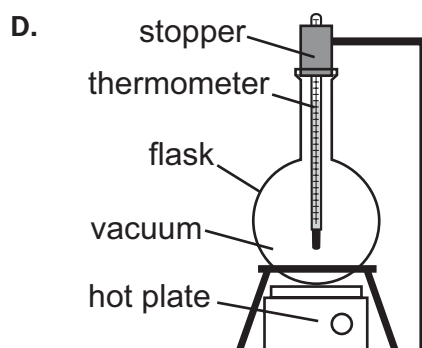
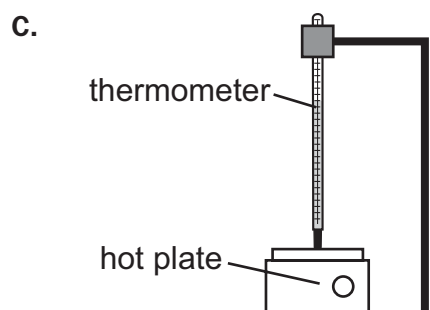
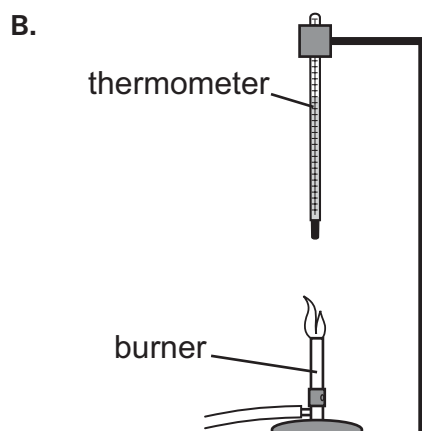
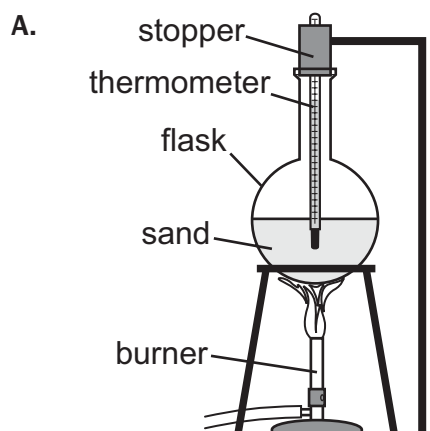

Item 11

Selected-Response

A student is investigating how a negatively charged rubber rod affects how charges are distributed on two stainless steel spheres that are touching each other. A diagram that shows two steps of the investigation is shown.

Investigation of the Process of Induction

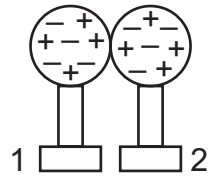

Step 1

Place two stainless steel spheres, both on hard rubber stands, in contact with each other.

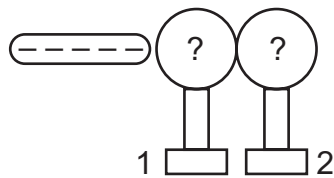

Step 2

Bring a negatively charged rubber rod near sphere 1.

Which diagram for step 2 correctly predicts the distribution of charges on the stainless steel spheres?

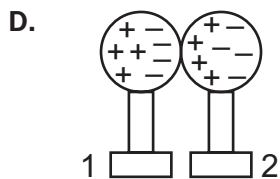
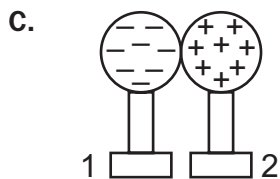
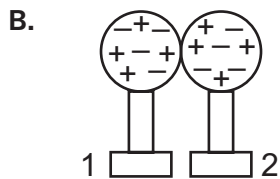
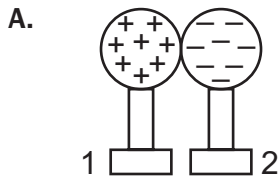

Item 12**Selected-Response**

A student wishes to use the pendulum and wooden block shown to investigate energy transfer between kinetic and potential.

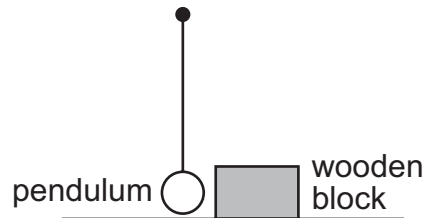

(Answer the question on the next page.)

Which procedure would BEST allow the student to complete measurements for the investigation and which energy transformation will occur during the investigation?

- A. step 1:** Release the pendulum from a measured height and allow it to swing down and collide with the wooden block at the bottom of the swing.
step 2: Allow the wooden block to come to rest, then measure the distance the block slid.
step 3: Repeat steps 1 and 2 using different starting heights for the pendulum. Compare the data for the different starting heights.
transformation: The potential energy of the pendulum transforms into kinetic energy, which then is transferred to the wooden block. The higher the pendulum is raised, the more potential energy the pendulum has. This means the pendulum will have more kinetic energy when it hits the block. This kinetic energy causes the block to travel. The more kinetic energy that is transferred from the pendulum, the farther the block will travel.
- B. step 1:** Release the pendulum from a measured height and allow it to swing down and collide with the wooden block at the bottom of the swing.
step 2: Allow the wooden block to come to rest, then measure the distance the block slid.
step 3: Repeat steps 1 and 2 using different starting heights for the pendulum. Compare the data for the different starting heights.
transformation: The kinetic energy of the pendulum transforms into potential energy, which then is transferred to the wooden block. The higher the pendulum is raised, the more kinetic energy the pendulum has. This means the pendulum will have more potential energy when it hits the block. This potential energy causes the block to travel. The more potential energy that is transferred from the pendulum, the farther the block will travel.
- C. step 1:** Pull the pendulum back and throw it downwards, allowing it to swing down and collide with the wooden block at the bottom of the swing.
step 2: Allow the wooden block to come to rest, then measure the distance the block slid.
step 3: Repeat steps 1 and 2, throwing the pendulum with different amounts of force. Compare the data for the different throws.
transformation: The potential energy of the pendulum transforms into kinetic energy, which then is transferred to the wooden block. The larger the force used to throw the pendulum, the more potential energy the pendulum has. This means the pendulum will have more kinetic energy when it hits the block. This kinetic energy causes the block to travel. The more kinetic energy that is transferred from the pendulum, the farther the block will travel.
- D. step 1:** Pull the pendulum back and throw it downwards, allowing it to swing down and collide with the wooden block at the bottom of the swing.
step 2: Allow the wooden block to come to rest, then measure the distance the block slid.
step 3: Repeat steps 1 and 2, throwing the pendulum with different amounts of force. Compare the data for the different throws.
transformation: The kinetic energy of the pendulum transforms into potential energy, which then is transferred to the wooden block. The larger the force used to throw the pendulum, the more kinetic energy the pendulum has. This means the pendulum will have more potential energy when it hits the block. This potential energy causes the block to travel. The more potential energy that is transferred from the pendulum, the farther the block will travel.

Waves

In this section, you will acquire a conceptual understanding of the nature of sound and electromagnetic radiation. You will study how sound behaves in the presence of different obstacles and how light is manipulated by positioning mirrors and lenses in its path.

KEY CONCEPTS

Waves are constant fluctuations that travel through space (either in the vacuum of outer space or through matter), transferring energy. When you throw a rock in a puddle, the water forms waves that move outward from the place where the rock hit the water. Waves can move through solids, liquids, gases, and empty space (i.e., a vacuum, a volume containing no matter). (S8P4a)

Frequency is the number of vibrations a wave makes per a unit of time, commonly measured in Hertz, which is waves per second. If you counted the number of wave peaks that occurred in a minute after throwing a rock in a puddle, you could determine the frequency of that wave. (S8P4f)

Wavelength is the distance from one peak of a wave to the next peak of the wave. (S8P4f)

Amplitude is the property of a wave that describes half the distance between the height of the peak of the wave and the trough (the bottom) of the wave, or the maximum distance from the resting position. In a surf wave, the amplitude represents the amount of water displaced, which can be very large. (S8P4f)

Electromagnetic radiation is a form of energy that is produced by oscillating electric and magnetic disturbances, or by the movement of electrically charged particles traveling through a vacuum or matter. It is used to describe radio waves, microwaves, infrared radiation, visible light, ultraviolet radiation, X-rays, and gamma rays. The **electromagnetic spectrum** consists of all the different kinds of electromagnetic radiation. Radio waves have the smallest frequency and longest wavelength in the electromagnetic (EM) spectrum (the complete set of electromagnetic radiation) and therefore contain the least energy. Gamma rays have the largest frequency and shortest wavelength in the EM spectrum and therefore contain the most energy. (S8P4a)

Electromagnetic waves do not require a medium to move through. Electromagnetic waves transport energy that is stored in the electric and magnetic fields. (S8P4a)

Mechanical waves are caused by a disturbance or vibration that causes the molecules in matter to bump into each other and transfer the energy from one molecule to the next in a set direction. Mechanical waves require matter to provide a **medium** for the waves to move through, so mechanical waves cannot occur in the vacuum of space. (S8P4a, e)

Sound is a mechanical wave that can be heard as it moves through a medium, such as air, and temporarily displaces the particles of the medium, either by rarefaction (the particles temporarily move farther apart, creating lower pressure) or compression (the particles temporarily move closer together, creating higher pressure). When fireworks go off on the Fourth of July, you can hear the sound. With some of the larger fireworks, you can also feel the air as the pressure from the firework exploding pushes the air away from the firework. (S8P4d)

When people refer to **light**, they are usually referring to the visible light they can see. Light is not considered matter and has no mass. The behavior of light can be explained by the introduction of a massless particle called a photon or by studying the way that electromagnetic waves interact with matter. (S8P4d)

There are several processes that light can go through as it encounters matter. **Reflection** occurs when light bounces off a medium. When light is reflected, not all the light is reflected. **Refraction** occurs when light moves from one medium to a new medium and bends as the medium changes the speed of the light as it moves through the new medium. When you look through a glass of water and an object behind

the glass appears to change shape, the light reflected by that object has been refracted by the glass.

Diffraction occurs when light encounters an obstacle and slightly bends as it passes around the object. If you hold a CD and see the colors of the rainbow, this is the light being diffracted by the surface of the CD.

Absorption occurs when light strikes a surface and the energy of the photon is taken up by the matter. An object lying in the sun will warm up as the sunlight transforms into heat energy. (S8P4d)

When the human eye sees **colors**, it is seeing the parts of the spectrum of light that are reflected from an object. A blue object reflects the wavelengths of light that we see as blue. (S8P4d)

Important Tip

✍ The way waves travel is known as wave propagation. As waves propagate, some of the energy is transferred. When light travels through a glass of water, it slows down and is refracted. Some of the energy that is lost from the wave—and that causes the light to slow down—is transferred into the water and glass as thermal energy. (S8P4b, d)

Sample Items 13–16

Item 13

Selected-Response

The model shows how light waves are transmitted through a transparent substance.

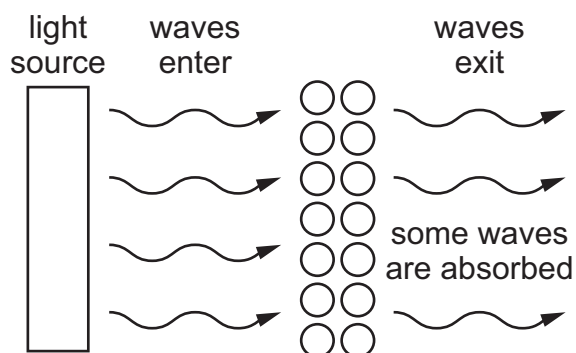

How would the model be different for a sound wave that is being transmitted through the same substance?

- A. The wavy arrows representing sound waves would have a smaller wavelength.
- B. The wavy arrows representing sound waves would go in the opposite direction.
- C. The atoms in the model would move parallel to the direction of the incoming wave.
- D. The atoms in the model would move perpendicular to the direction of the incoming wave.

Item 14**Selected-Response**

The diagram shows three types of electromagnetic radiation and their range of frequencies.

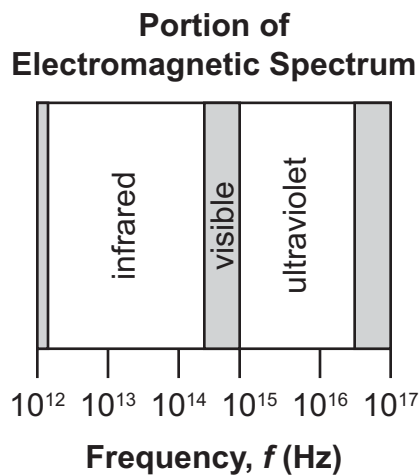

Which explanation correctly uses the data in the diagram to show how infrared radiation and ultraviolet radiation are related in terms of energy?

- A. Ultraviolet radiation has less energy than infrared radiation because energy is inversely proportional to frequency and the frequency of ultraviolet radiation is higher.
- B. Ultraviolet radiation has more energy than infrared radiation because energy is inversely proportional to frequency and the frequency of ultraviolet radiation is lower.
- C. Ultraviolet radiation has less energy than infrared radiation because energy is proportional to frequency and the frequency of ultraviolet radiation is lower.
- D. Ultraviolet radiation has more energy than infrared radiation because energy is proportional to frequency and the frequency of ultraviolet radiation is higher.

Item 15

Selected-Response

A student drew the diagram below to model an electromagnetic wave from the sun.

Model of Electromagnetic Wave from Sun

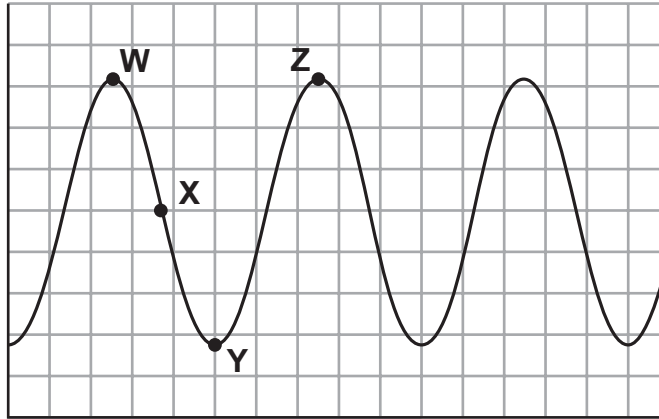

Scientists have shown that ultraviolet light from the sun that has a wavelength of 315 to 400 nm can damage the retina. Which question is the **BEST** question for the student to ask to determine whether the electromagnetic wave modeled will cause damage to the retina?

- A. What is the vertical distance between point Y and point Z on the model?
- B. What is the vertical distance between point X and point Y on the model?
- C. What is the horizontal distance between point W and point Z on the model?
- D. What is the horizontal distance between point W and point Y on the model?

Item 16

Multi-Select Technology-Enhanced

A student questioned how the properties of different materials affect the speed of sound waves traveling through them. The student found the following data in a chemistry handbook for the speed of sound in gases, liquids, and solids.

Speed of Sound in Different Materials at Room Temperature

State	Material	Density (kg/m ³)	Speed of Sound (m/s)
gas	carbon dioxide	1.842	267
	helium	0.166	1,007
	methane	0.668	446
liquid	benzene	874	1,310
	ethanol	789	1,162
	water	1,000	1,497
solid	aluminum	2,700	6,420
	copper	8,790	5,010
	gold	19,290	3,240

The student analyzed the data to make predictions about the speed of sound on materials with various densities and states of matter. Which **TWO** predictions can be made based on the data shown in the table?

- A. The speed of sound generally increases as it moves from gases to liquids to solids.
- B. The speed of sound generally increases as it moves from liquids to gases to solids.
- C. The speed of sound generally increases as it moves from solids to gases to liquids.
- D. As the density of liquids and solids increases, the speed of sound generally increases.
- E. As the density of gases and liquids increases, the speed of sound generally decreases.
- F. As the density of solids and gases increases, the speed of sound generally decreases.

Motion and Force

In this section, you will focus on acquiring a conceptual understanding of energy conservation; heat transfer processes; and the relationships between force, mass, and acceleration. Throughout this section, you will be expected to analyze scientific data by collecting, using, interpreting, and comparing experimental results.

KEY CONCEPTS

Displacement is the length and direction of a straight line between two locations, or positions. Since displacement considers only the length and direction of a straight line, it doesn't depend on the actual path of a moving object. If Town A is 10 miles east of Town B, the displacement of Town A is 10 miles east relative to Town B. For a moving object, displacement can be defined as the change between the initial and final position of the object. (S8P3a)

Distance is a measure of the length of a path that a moving object travels. If the only road between the two towns has to wind through hills, the distance traveled between the two towns is longer than 10 miles, even though the displacement between the two towns is 10 miles east. (S8P3a)

Velocity is a quantity that measures the rate at which the position of an object changes in time. Velocity always describes a distance and a direction. Since velocity has direction, one way to show this numerically is to assume that travelling in a certain direction is symbolized with positive numbers while traveling opposite that direction is shown using negative numbers. (S8P3a)

Speed measures the rate at which an object moves along a path. Unlike velocity, speed is not considered to have a direction. (S8P3a)

Acceleration is a quantity that measures the rate at which an object changes its velocity. People often talk about an object decelerating when the object slows down. An object that slows down is actually experiencing a negative acceleration. This means the rate of change is a negative value. An object can have a velocity but not acceleration if it is moving at a constant velocity. For example, a car takes one hour to make a trip of 80 kilometers on a straight road pointing due east. In the middle of the trip, the car accelerated to 100 kilometers per hour (kph) and operated at that speed for 10 minutes and then accelerated to 60 kph and operated at that speed for 10 minutes. After the first acceleration the speed of the car was 100 kph, and during that time, the velocity of the car was 100 kph eastward. After the second acceleration the speed of the car was 60 kph and the velocity of the car during that time was 60 kph eastward. Finally, the car accelerated again back to 80 kph. The average velocity of the car over the whole trip was 80 kph eastward, and the average speed was 80 kph. (S8P3a)

A **force** is a push or pull on an object. Force can be the result of contact, such as when you push a book across your desk. Forces between objects that are not in contact with each other can be explained by the presence of force fields, like the magnetic field and the gravitational field. When one magnet repels another magnet, there is a push force that acts on the magnets even though the magnets are not in contact. (S8P3b)

When two or more forces act on an object but the object's velocity does not change, the object is being acted on by **balanced forces**. A book on your desk that is not moving is said to be **stationary**. The book is said to be at **rest** in relation to the desk. Gravity is acting to pull the book down. The desk pushes up against the book, and the book is at rest in relation to the desk. (S8P3b)

An accelerating object is being acted on by **unbalanced forces**. When you push your book across your desk, you are applying force to one side of the book. The force of friction acts on the book in the opposite direction that the book is moving, reducing the speed at which the book moves. Because the book still begins to move in the direction you are pushing it, these forces are unbalanced. (S8P3b)

Friction is the force that resists motion between two surfaces. (S8P3b)

Inertia is the resistance to any change in the state of motion of any physical object. All matter has inertia, and the inertia of matter does not change until the matter is acted on by unbalanced forces that cause a change in motion. (S8P3b)

Gravity is the force of attraction that exists between any two or more masses. Gravity can refer to the force that Earth exerts on everything. (S8P3b, S8P5a)

Sample Items 17–20

Item 17

Selected-Response

Two toy cars move in the same direction with velocities that are shown in the graph.

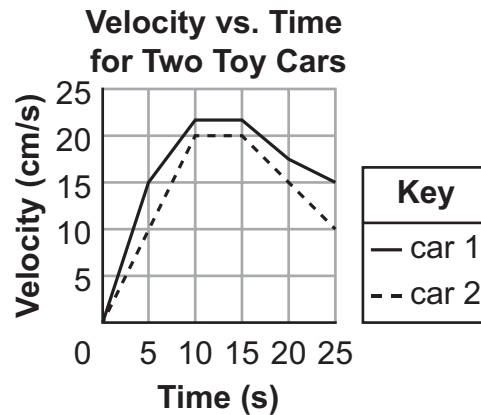

Based on the information in the graph, which statement describes the motion of the two toy cars?

- A. Car 1 is traveling faster than car 2.
- B. Car 2 is traveling farther than car 1.
- C. Car 1 has constant velocity between 0 and 10 seconds.
- D. Car 2 is changing direction between 10 and 15 seconds.

Item 18**Selected-Response**

A lab group is investigating how Earth's gravitational acceleration affects the force exerted on toy blocks of different masses. The diagram shows the results of their investigation.

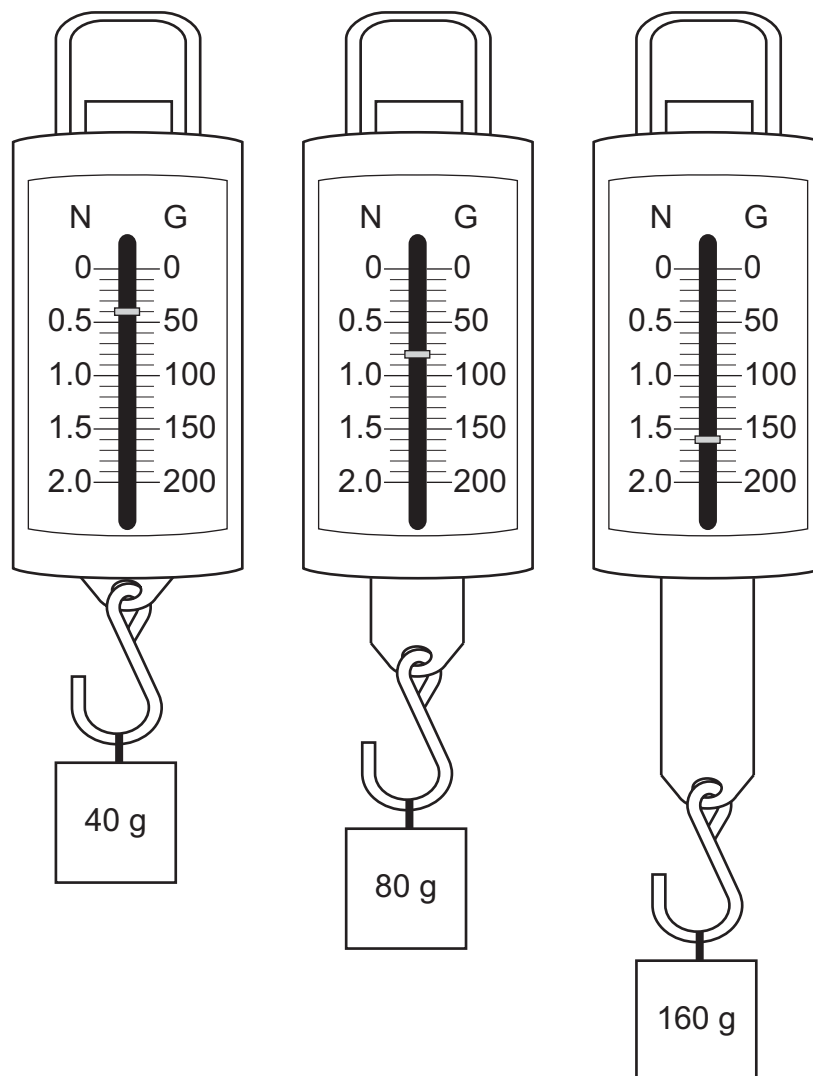
Force vs. Mass Investigation

The group claims that the amount of force needed to accelerate a toy block is directly proportional to its inertia.

(Answer the question on the next page.)

Which explanation presents the BEST argument for whether the group's claim is true?

- A. The claim is false because every time the mass of the metal cube is increased, the pointer on the spring scale moves downward.
- B. The claim is true because every time the mass of the metal cube is doubled, the gravitational force doubles.
- C. The claim is false because every time the volume of the metal cube is increased, the pointer on the spring scale moves downward.
- D. The claim is true because every time the volume of the metal cube is doubled, the gravitational force doubles.

Item 19

Selected-Response

Students are exploring the relationship between velocity and acceleration. This graph shows the acceleration of a remote-controlled toy car.

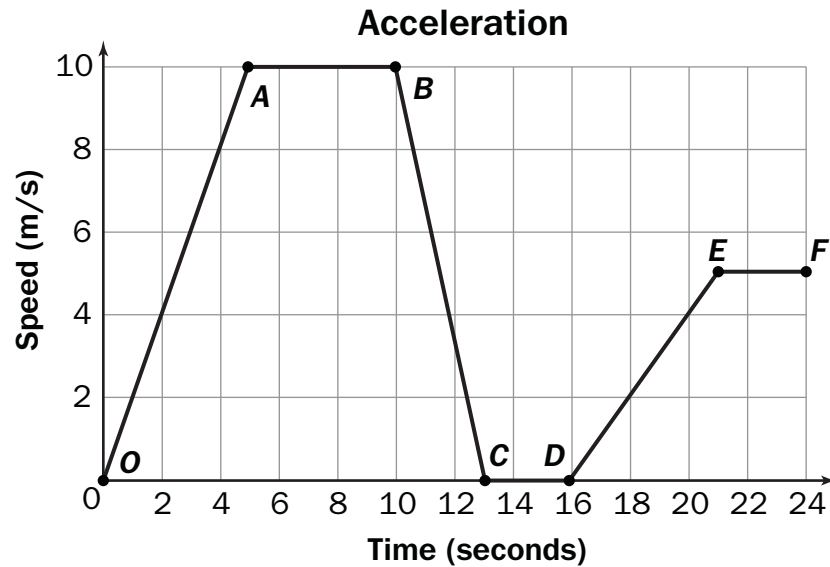

Which statement is TRUE based on the graph?

- A. Segment *BC* and segment *EF* show constant speed.
- B. Segment *OA* and segment *BC* show constant speed.
- C. Segment *AB* and segment *CD* show positive acceleration.
- D. Segment *OA* and segment *DE* show positive acceleration.

Item 20

Multi-Select Technology-Enhanced

A magnet is moved toward a paper clip, as shown in the drawing. Students want to investigate how the strength of the force between the paper clip and a magnet changes under different conditions.

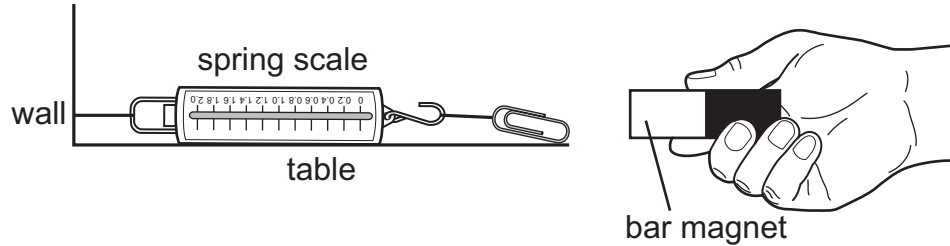

Which **TWO** factors should the students vary to **BEST** investigate the strength of the force between the paper clip and a magnet?

- A. Attach the spring scale to the table.
- B. Move the magnet farther away from the paper clip.
- C. Replace the bar magnet with a horseshoe magnet.
- D. Replace the spring scale with a larger spring scale.
- E. Increase the length of the string attaching the spring scale to the wall.
- F. Increase the length of the string attaching the spring scale to the paper clip.

SCIENCE ADDITIONAL SAMPLE ITEM KEYS

Item	Standard/ Element	DOK Level	Correct Answer	Explanation
1	S8P3a	2	D	The correct answer is choice (D) The runner starts slower and speeds up, reaching a maximum speed between 50 and 70 m, and then slows down during the final 30 m. Choice (A) is incorrect because the runner's speed is not constant during the first 80 m because the slope is not the same, and the minimum speed occurs during the first 10 m. Choice (B) is incorrect because the runner's speed is not constant between 20 and 80 m because the slope is not the same, and the runner is slowing down during the final 20 m. Choice (C) is incorrect because the runner actually speeds up during the first 70 m, reaching a maximum constant speed between 50 and 70 m, and then slows down during the last 30 m.
2	S8P3b	3	C	The correct answer is choice (C) The skier's speed increases going down the hill because forces F_3 and F_4 are unbalanced, with F_3 acting in the same direction as the velocity, causing the skier to speed up. Choices (A) and (B) are incorrect because the net force is zero perpendicular to the ski slope so these forces are not responsible for the motion of the skier. Choice (D) is incorrect because while F_3 and F_4 are unbalanced, force F_3 is larger, so the skier is speeding up, not slowing down.
3	S8P3a	3	D	The correct answer is choice (D) The direction of the velocity is upward for the first second and then downward for the last second, and the acceleration remains constant for the entire period. Because the velocity is positive between time 0 and 1 second the shot is traveling upward during this time period. Because the velocity is negative between 1 second and 2 seconds, the shot is traveling downwards during this time period. Choice (A) is incorrect because the velocity of the shot is actually negative for the last second so the direction of the velocity is downward for that period. Choice (B) is incorrect because the velocity of the shot is positive for the first second so the direction is upward. The slope is constant, so the acceleration is constant. Choice (C) is incorrect because although the line drops down to the right and the slope is negative, the change in the slope is constant, so the acceleration is constant.
4	S8P1c	2	B	The correct answer is choice (B) investigation: Add a small amount of solid to a liquid in a beaker. observation: The solid dissolves into the liquid. This is correct because the investigation tests the solubility of the solid substance, and solubility is a physical property. Choices (A), (C) and (D) are incorrect because reactivity is a chemical property.

Item	Standard/ Element	DOK Level	Correct Answer	Explanation
5	S8P1a	2	D	<p>The correct answer is choice (D). Choice D is correct because model 1 shows a heterogeneous mixture and the description is accurate, and model 2 shows a pure substance (iron sulfide compound) and the description is accurate. Choice (A) is incorrect because model 1 shows a heterogeneous mixture and would not be uniform in appearance. Model 2 shows a pure substance and would appear uniform. Choice (B) is incorrect because model 1 and the description apply to heterogeneous mixtures. Model 2 and the description apply to pure substances. Choice (C) is incorrect because model 1 is a heterogeneous mixture that would not appear uniform.</p>
6	S8P1b	3	D, D	<p>The correct answer for Part A is choice (D) Decrease the velocities of the particles, and decrease the space between the particles. Choice (A) is incorrect because it would increase the temperature and not produce a solid. Choice (B) is incorrect because it would increase the temperature and density but would not produce a solid. Choice (C) is incorrect because the space between the particles would decrease.</p> <p>The correct answer for Part B is choice (D) Increase the velocities of the particles, but maintain the same space between the particles. Choices (A) and (B) are incorrect because they would show a change of state to a plasma. Choice (C) is incorrect because would show a lower temperature.</p>

Item	Standard/ Element	DOK Level	Correct Answer	Explanation
7	S8P1c	3	C, A	<p>The correct answer for Part A is choice (C)</p> <ol style="list-style-type: none"> 1. Use a ruler to measure the length of one side of the sample. 2. Record this value to the nearest millimeter. 3. Cube the value in step 2. 4. Place the cubed sample on the digital balance. 5. Record this value to the nearest tenth of a gram. 6. Divide the value in step 5 by the value in step 3. <p>This choice is correct because this process allows the student to measure the density of the block of salt, which is a physical property. Choices (A) and (B) are incorrect because this is testing a chemical property. Choice (D) is incorrect because the time it takes the sample to increase in temperature is not a physical property.</p> <p>The correct answer for Part B is choice (A) The physical property being tested is density; the procedure selected measures the mass and the volume of the sample. Choice (B) is incorrect because reactivity is a chemical property. Choice (C) is incorrect because none of the options in Part A actually tests the melting point of a sample. Choice (D) is incorrect because combustibility is a chemical property.</p>
8	S8P2a	3	D	<p>The correct answer is choice (D). Choice D is correct because the graph shows the kinetic energy increasing as the square of the velocity during the two time periods when the object is increasing in speed. Choice (A) is incorrect because the last section is linear rather than proportional to the square of the velocity. Choice (B) is incorrect because the relationship to the velocity is linear between these values instead of proportional to the square of the velocity. Choice (C) is incorrect because the curvature of the line indicates that the vehicle's kinetic energy increases less as its velocity continues to linearly increase.</p>
9	S8P5a	3	A	<p>The correct answer is choice (A) The velocity of the asteroid changed as evidenced by the changing direction of the asteroid. Choice (B) is incorrect because a straight line path does not necessarily indicate a change in velocity and not enough points are shown for this latter stage of the asteroid's path to make that determination. Choice (C) is incorrect because the path of the asteroid bends toward Earth, not away from it. Choice (D) is incorrect because the asteroid's positions indicate that the asteroid is not bending toward the sun.</p>

Item	Standard/ Element	DOK Level	Correct Answer	Explanation
10	S8P2d	2	D	The correct answer is choice (D). Choice (D) shows the thermometer surrounded by a vacuum; therefore, conduction and convection cannot transfer thermal energy to the thermometer since they require the movement of energy through matter. Radiation, however, can transfer through a vacuum. Choice (A) is incorrect because this would eliminate heat transfer by convection, which does not occur in solids or masses of granular solids like sand, but not conduction and would not add radiation. Choice (B) is incorrect because convection is still occurring to transfer thermal energy from the flame to the thermometer and conduction still occurs to transfer thermal energy from the air to the thermometer itself. Choice (C) is incorrect because a hot plate touching the thermometer would heat the thermometer by conduction.
11	S8P5b	2	A	The correct answer is choice (A). Choice (A) is correct because the negatively charged rod will repel negative charges from the nearer (left) sphere, so that they will flow into the more distant sphere. Similarly, positive charges in the more distant (right) sphere will be attracted to the negatively charged rod, so will flow into the left sphere. Choice (B) is incorrect because the charges on the two spheres don't simply mix to form a uniform distribution of charges on both spheres, but rather the positive charges should accumulate on the left sphere and negative charges on the right sphere. Choice (C) is incorrect because the negatively charged rod attracts opposite charges, not like charges, thus the positive charges should accumulate on the left sphere and negative charges on the right sphere. Choice (D) is incorrect because this would be the distribution of charges if the two spheres were located close together but not touching when the negatively charged rod is brought near the left sphere.

Item	Standard/ Element	DOK Level	Correct Answer	Explanation
12	S8P2b	3	A	<p>The correct answer is choice (A) step 1: Release the pendulum from a measured height and allow it to swing down and collide with the wooden block at the bottom of the swing.</p> <p>step 2: Allow the wooden block to come to rest, then measure the distance the block slid.</p> <p>step 3: Repeat steps 1 and 2 using different starting heights for the pendulum. Compare the data for the different starting heights.</p> <p>transformation: The potential energy of the pendulum transforms into kinetic energy, which then is transferred to the wooden block. The higher the pendulum is raised, the more potential energy the pendulum has. This means the pendulum will have more kinetic energy when it hits the block. This kinetic energy causes the block to travel. The more kinetic energy that is transferred from the pendulum, the farther the block will travel.</p> <p>Choice (B) is incorrect because the pendulum starts with potential energy, which is transferred to kinetic as it falls, which then is transferred to kinetic energy of the block. Choice (C) is incorrect because the procedure shown here does not allow for measurements of the initial kinetic energy or potential energy of the pendulum. Choice (D) is incorrect because the procedure does not measure the initial kinetic energy or potential energy of the pendulum.</p>
13	S8P4d	2	C	<p>The correct answer is choice (C) The atoms in the model would move parallel to the direction of the incoming wave. Choice (A) is incorrect because sound would not change in wavelength when transmitted. Choice (B) is incorrect because this would show reflection. Choice (D) is incorrect because atoms do not move perpendicular to the direction of sound waves, as sound waves are longitudinal.</p>
14	S8P4b	2	D	<p>The correct answer is choice (D) Ultraviolet radiation has more energy than infrared radiation because energy is proportional to frequency and the frequency of ultraviolet radiation is higher. Choice (A) is incorrect because the energy is inversely proportional to the wavelength of the radiation, not the frequency, so the ultraviolet radiation should have more energy than infrared radiation. Choice (B) is incorrect because the energy is inversely proportional to the wavelength of the radiation, not the frequency, and the frequency of ultraviolet radiation is higher, not lower. Choice (C) is incorrect because the frequency of ultraviolet radiation is higher, not lower; thus it should have more energy, not less energy, than infrared radiation.</p>

Item	Standard/ Element	DOK Level	Correct Answer	Explanation
15	S8P4b	2	C	The correct answer is choice (C) What is the horizontal distance between point W and point Z on the model? Choice (A) is incorrect because this represents the wave height, not the wavelength of the wave modeled. Choice (B) is incorrect because this represents the amplitude of the wave, not the wavelength of the wave modeled. Choice (D) is incorrect because this only represents half the wavelength and not the full wavelength of the wave modeled.
16	S8P4e	3	A, F	The correct answers are choice (A) The speed of sound generally increases as it moves from gases to liquids to solids, and choice (F) As the density of solids and gases increases, the speed of sound generally decreases. Choice (B) is incorrect because the general trend is increasing speed from gases to liquids. Choice (C) is incorrect because the speed of sound generally increases as it moves from gases to liquids to solids, not solids to gases to liquids. Choice (D) is incorrect because this statement is true of gases, but not solids. Choice (E) is incorrect because this statement is true of gases, but not liquids.
17	S8P3a	2	A	The correct answer is choice (A) Car 1 is traveling faster than car 2 since car 1 has a larger velocity than car 2 during the same 25 seconds. Choice (B) is incorrect because car 1 travels farther than car 2. Choice (C) is incorrect because car 1 is moving at a constant acceleration during this time. Choice (D) is incorrect because the graph shows only that the velocity changed in magnitude but not in direction.
18	S8P3c	2	B	The correct answer is choice (B) The claim is true because every time the mass of the metal cube is doubled, the gravitational force doubles. Choice (A) is incorrect because the claim is true. Choice (C) is incorrect because the claim is true and inertia depends on mass, not volume. Choice (D) is incorrect because the mass of the metal cube is a better representation of the inertia than the volume which is not represented quantitatively in the investigation to determine a proportionality with gravitational force.

Item	Standard/ Element	DOK Level	Correct Answer	Explanation
19	S8P3a	2	D	The correct answer is choice (D) Segment <i>OA</i> and segment <i>DE</i> show positive acceleration. Choice (A) is incorrect because segment <i>BC</i> shows negative acceleration and segment <i>EF</i> shows constant speed. Choice (B) is incorrect because segment <i>OA</i> shows positive acceleration and segment <i>BC</i> shows negative acceleration, not constant speed. Choice (C) is incorrect because segment <i>AB</i> shows constant speed as shown by the straight line. Segment <i>CD</i> shows speed of zero.
20	S8P5c	3	B, C	The correct answers are choice (B) Move the magnet farther away from the paper clip, and choice (C) Replace the bar magnet with a horseshoe magnet. Each of these changes a characteristic/factor that influences the strength of the magnetic force. Choice (A) is incorrect because changing where the scale is attached does not test the strength of the magnetic force. Choice (D) is incorrect because the size of the scale does not test the strength of the magnetic force. Choice (E) is incorrect because the length of the string attached to the wall does not test the strength of the magnetic force. Choice (F) is incorrect because the length of the string attached to the paper clip does not test the strength of the magnetic force.

SOCIAL STUDIES

DESCRIPTION OF TEST FORMAT AND ORGANIZATION

The Grade 8 Social Studies EOG assessment has a total of 76 items.

The test will be given in two sections.

- You may have up to 70 minutes per section to complete Sections 1 and 2.
- You will have about 90 to 140 minutes for the complete Social Studies EOG assessment.

CONTENT

The Grade 8 Social Studies EOG assessment will measure the Grade 8 Social Studies standards that are described at www.georgiastandards.org.

The content of the assessment covers standards that are reported under these domains:

- History
- Geography
- Government and Civics
- Economics

ITEM TYPES

Operational items in the Social Studies portion of the Grade 8 EOG assessment consist of selected-response (multiple-choice) and technology-enhanced items.

SOCIAL STUDIES DEPTH-OF-KNOWLEDGE EXAMPLE ITEMS

Example items that represent applicable DOK levels of the Social Studies assessment are provided on the following pages. The items and explanations of what is expected of you to answer them will help you prepare for the test.

All example and sample items contained in this guide are the property of the Georgia Department of Education.

Example Item 1

Selected-Response

DOK Level 1: This is a DOK level 1 item because it asks students to recall a fact.

Social Studies Grade 8 Content Domain: History

Standard: SS8H2. Analyze the colonial period of Georgia's history.

- a. Explain the importance of the Charter of 1732, including the reasons for settlement (philanthropy, economics, and defense).

What was one purpose of the founding of Georgia?

- A. to establish bases to expand the fur trade
- B. to learn about the culture of the native people
- C. to provide military protection for other colonies
- D. to establish places to practice religious freedom

Correct Answer: C

Explanation of Correct Answer: The correct answer is choice (C) to provide military protection for other colonies. Choice (A) is incorrect because although the fur trade was important to some early explorers and settlers, this was not the purpose of the founding of Georgia colony. Choice (B) is incorrect because although the first settlers of Georgia did interact with the native people, this was not one purpose for the founding of the colony. Choice (D) is incorrect because although some British colonies were established as places where settlers could worship freely, this was not one purpose of the founding of Georgia.

Example Item 2

Selected-Response

DOK Level 2: This is a DOK level 2 item because it involves reasoning and comparing.

Social Studies Grade 8 Content Domain: Geography

Standard: SS8G1. Describe Georgia's geography and climate.

b. Distinguish among the five geographic regions of Georgia in terms of location, climate, agriculture, and economic contribution.

Read the information in the box.

This region of Georgia contains the highest elevation in the state. This area also receives the most rainfall of any of the regions.

Which geographic region is described in the box?

- A. Coastal Plain
- B. Valley and Ridge
- C. Appalachian Plateau
- D. Blue Ridge Mountains

Correct Answer: D

Explanation of Correct Answer: The correct answer is choice (D) Blue Ridge Mountains. This region contains the highest mountain range and receives the most rain of all the regions in the state of Georgia. Choices (A), (B), and (C) are all incorrect because they are regions in the state that do not match the description in the box. They receive less rain and are at lower elevations than the Blue Ridge Mountains.

Example Item 3

Selected-Response

DOK Level 3: This is a DOK level 3 item because students must evaluate the advantage described in each answer choice and make an inference as to which one would meet a given criterion.

Social Studies Grade 8 Content Domain: History

Standard: SS8H12. Explain the importance of developments in Georgia since the late 20th century.

d. Analyze Georgia's role in the national and global economy of the 21st Century, with regard to tourism, Savannah port expansion, and the film industry.

A production company is considering filming a movie in Georgia. Which statement would probably be MOST persuasive in convincing the company to film in Georgia?

- A. Georgia's rivers provide recreational opportunities for production companies.
- B. Georgia's many hotels and restaurants are available to serve production companies.
- C. Georgia's state and local governments offer financial incentives to production companies.
- D. Georgia's unemployed people are available for temporary work with production companies.

Correct Answer: C

Explanation of Correct Answer: The correct answer is choice (C) Georgia's state and local governments offer financial incentives to production companies. Georgia's state government has offered significant tax credits to film and television production companies as an incentive to attract new business to the state. Choices (A), (B), and (D) are incorrect because although Georgia's physical features, hospitality services, and available workers would be attractive to production companies, these would not likely be the most persuasive factors in determining film locations.

SOCIAL STUDIES CONTENT DESCRIPTION AND ADDITIONAL SAMPLE ITEMS

In this section, you will find information about what to study in order to prepare for the Grade 8 Social Studies EOG assessment. This includes key terms and important vocabulary words. This section also contains practice questions, with explanations of the correct answers, and activities that you can do with your classmates or family to prepare for the assessment.

The organization of Social Studies units in this guide is based on Frameworks developed by the Curriculum and Instruction Division of the Georgia Department of Education. The Social Studies section begins with Unit 2. Unit 1 focuses on overarching themes and concepts, rather than on specific standards. Unit 1 will, therefore, not be a part of the EOG assessment. These Frameworks can be accessed at <https://www.georgiastandards.org/Georgia-Standards/Pages/Social-Studies-Grade-8.aspx>.

All example and sample items contained in this guide are the property of the Georgia Department of Education.

Content Description

The four domains (History, Geography, Government and Civics, and Economics) are fully integrated.

Some of the topics you will study in this guide are the following:

- Georgia history, geography, government, and economics
- Georgia's role in the history of the United States and the impact of historical events on the state, with a primary focus on the period from the Civil War to the present
- Georgia's role in and contributions to American history
- The impact of historical figures and events and how they shape and define contemporary economic, political, and social conditions in Georgia
- The influence of location and physical features on economic growth and development in the state of Georgia
- Georgia's location relative to the nation, continent, and Western Hemisphere
- The process of government in the state of Georgia and the political role of citizens under its constitution
- The political and legal structures and institutions that govern Georgia
- The factors that have influenced and shaped Georgia's economic growth and development
- The importance of both domestic and international trade, the role of the entrepreneur in generating economic growth and productivity, personal money management, and government revenue sources

Unit 2: Geography of Georgia and the American Indians

In this unit, you will study the geography of Georgia. You will learn about the rivers, mountains, plains, and plateaus. You will locate specific places, such as the barrier islands and Okefenokee Swamp. You will learn about the climate in the state. You will also learn about the development that occurred among prehistoric cultures.

KEY TERMS

American Indians: Many groups of American Indians lived in what is now Georgia when the first Europeans arrived. These groups typically obtained food by farming, hunting, fishing, and gathering. They grew corn and other vegetables and hunted deer and other game. They used tools such as bows and arrows, nets, traps, and spears. Many Indians lived in wattle and daub houses, which were made of walls from interwoven sticks and twigs covered with mud or clay. (SS8H1a)

Appalachian Mountains: A large mountain chain in eastern North America extending from Canada into Alabama. (SS8G1c)

Barrier islands: A group of mostly undeveloped islands along Georgia's coast. The islands protect the mainland from storms and erosion. (SS8G1c)

Chattahoochee River: A long river that flows from northern Georgia along the Georgia/Alabama border and into the Apalachicola River. The river is used for rafting and fishing and is a national recreation area. (SS8G1c)

Fall Line: A geological boundary that divides the rocks of the upper Coastal Plain from those of the Piedmont. Because the line is marked by rivers, it has been a center for commerce and trade throughout Georgia's history. (SS8G1c)

Georgia: A state in the southern United States and the last of the thirteen original colonies. It is the largest state east of the Mississippi River. Parts of Georgia have a subtropical climate, but the areas northwest of the Chattahoochee River are cooler. The state is the largest producer of peanuts in the United States. (SS8G1a)

Okefenokee Swamp: A large but shallow wetland in southeast Georgia and northeast Florida. It is the largest freshwater swamp in North America. Much of the area is today protected as part of a national refuge. (SS8G1c)

Regions: Georgia can be divided into regions based on similarities in geographic features such as climate, rocks and minerals, soil, elevation, and vegetation. The state is often divided into these five regions: Appalachian Plateau, Valley and Ridge, Blue Ridge, Piedmont, and Coastal Plain. (SS8G1b)

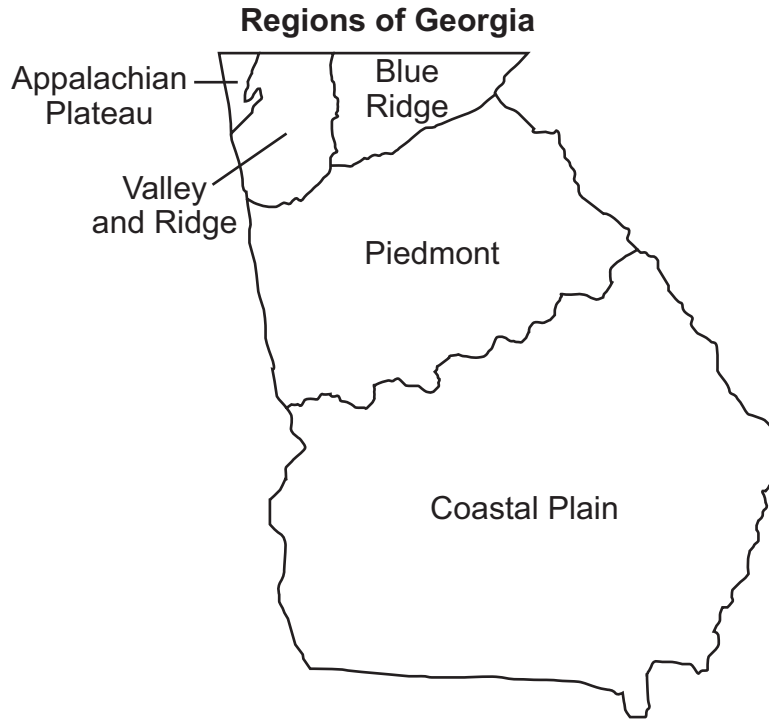

Savannah River: A river that begins in South Carolina, flows along the South Carolina/Georgia border, and empties into the Atlantic Ocean. It is about 300 miles long. (SS8G1c)

KEY IDEA**Regions of Georgia**

Region	Location	Climate	Agriculture	Economic Contribution
Appalachian Plateau	northwestern Georgia	cooler temperatures, some snow and ice in winter	corn, soybeans	coal, forestry, limestone, tourism
Valley and Ridge	northern Georgia	cooler temperatures, some snow and ice in winter	corn, cotton, soybeans, timber, wheat	mining, textiles
Blue Ridge	northeastern Georgia	cooler temperatures, highest precipitation rate	apples, corn, livestock, vegetables	mining, timber
Piedmont	central Georgia	hot and humid summers, some snow in winter	cattle, cotton, hogs, poultry/eggs, soybeans, wheat	aircraft and automobile manufacturing, carpet milling, poultry processing, timber
Coastal Plain	southern Georgia	hot and humid summers, cool winters	cotton, onions, peaches, peanuts, pecans, soybeans	fishing, pulp and paper, recreation, seafood processing, tourism

(SS8G1b)

Sample Items 1–2

Item 1

Selected-Response

Which phrase **BEST** describes the shelters of many American Indians living in Georgia at the time of European contact?

- A. pueblos made from adobe bricks
- B. longhouses made from thick cedar planks
- C. tepees made from wooden poles covered with buffalo hides
- D. circular houses made from interwoven sticks covered with mud

Item 2

Selected-Response

Examine the map.

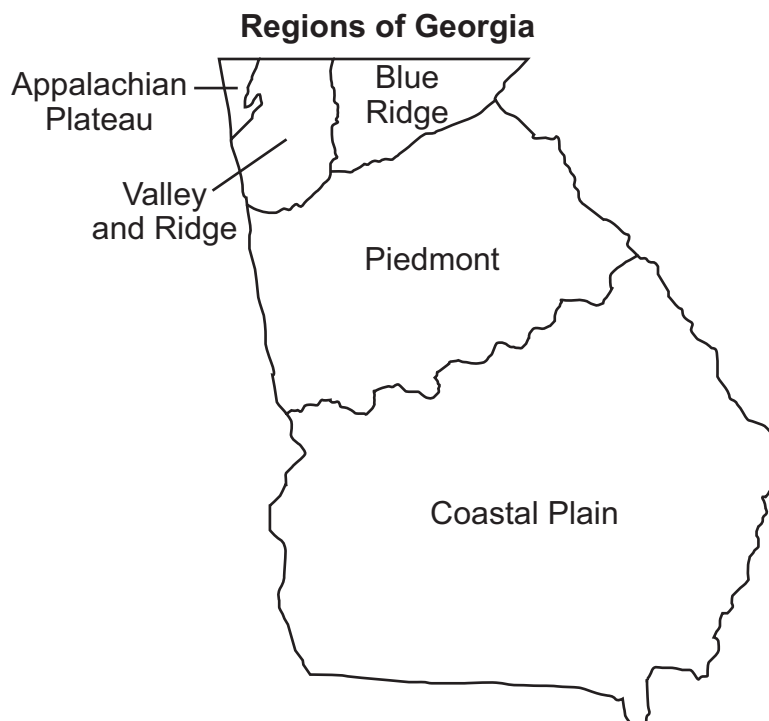

In which region of Georgia is the Okefenokee Swamp located?

- A. Piedmont
- B. Blue Ridge
- C. Coastal Plain
- D. Valley and Ridge

Unit 3: Exploration and Colonization

In this unit, you will learn about Georgia's past. You will study the explorers who came here and set up colonies. You will learn about the American Indians who lived in Georgia. You will read about the royal governors who ruled the state at one time.

KEY TERMS

Charter of 1732: Signed by King George II, it established the royal colony of Georgia and appointed a Board of Trustees to govern it. (SS8H2a)

Hernando de Soto: A Spanish explorer and conquistador who landed in what came to be known as Florida in 1539. He explored the Southeast, including Georgia, from 1539 to 1542. He and his 600 men searched for wealth, sparking conflict with American Indian groups, whom they exploited and enslaved. (SS8H1c)

European exploration: The Spanish and British sent explorers to the southeastern part of North America. The Spanish, believing the area to be rich in gold, searched for wealth. They also believed it was their mission to convert the natives to Christianity. The British wanted to colonize the area for a number of reasons. Some sought the riches offered by the area's abundance of resources. Others hoped to escape religious persecution in Europe. (SS8H1b)

Highland Scots: A group of Scottish people who came to Georgia in the 1730s. Known for being good soldiers, they provided protection for the colony. They founded the city of Darien along the colony's southern border. (SS8H2c)

Jews: People descended from the Hebrews of the Middle East whose traditional religion is Judaism. The trustees included a prohibition of Jews in Georgia in the original charter; however, a group of Portuguese Jews arrived in Georgia soon after the colony was established. In the group was a doctor, Samuel Nunes, who is often credited for "saving the colony." Against the rules of the trustees, Oglethorpe allowed the Jewish immigrants to settle in Savannah. (SS8H2c)

Land ownership: Under the royal charter signed by King George II, colonists were not permitted to own land. This caused discontent, because of their hard work in developing and cultivating the region. (SS8H2d)

Malcontents: A group of mostly Scottish colonists who loudly opposed the policies of James Oglethorpe and Georgia's Board of Trustees. (SS8H2c)

Mary Musgrove: An American Indian woman who was James Oglethorpe's Creek interpreter and negotiator during Georgia's earliest years. (SS8H2b)

James Oglethorpe: The British general and philanthropist who helped to found the colony of Georgia. Oglethorpe was one of the original trustees, and the only trustee to come to Georgia. (SS8H2b)

Philanthropy: The desire to help others (charity). Philanthropy, economics, and defense were the main reasons for Georgia's founding. James Oglethorpe and the trustees hoped to create a colony for the poor and debt-ridden people of England. However, no debtor was ever released from debtors' prison to come to Georgia. (SS8H2a)

Salzburgers: A group of German-speaking Protestant refugees who helped settle the colony of Georgia in the 1730s. (SS8H2c)

Savannah: A Georgia city near the mouth of the Savannah River, founded in 1733 by James Oglethorpe. Savannah was Georgia's first city and first capital. (SS8H2b)

Slavery: A condition in which people are considered legal property of someone and are forced to obey their owners. The Charter of 1732 banned slavery in the colony of Georgia, but many colonists growing labor-intensive crops felt that they needed enslaved workers in order to become as economically stable and successful as the Carolinas. (SS8H2d)

Spanish missions: Places of worship set up by Spanish Catholic missionaries to convert native peoples to Christianity. In Georgia, many such places were established along the barrier islands. (SS8H1c)

Tomochichi: A Creek leader who acted as a mediator between British settlers in Georgia and the American Indians of the region. (SS8H2b)

Trustee Period: The period from 1732 to 1752 when a board of trustees governed the colony of Georgia. (SS8H2c)

Sample Items 3–4

Item 3

Selected-Response

Read the information in the chart.

	Dates of Exploration/Colonization of the Southeast	Motives for Exploration and Colonization	Key Details
Spanish	1500s–1600s	Conversion of American Indians to Catholicism, adaptation of American Indians to Spanish social and economic colonial system, and the search for silver and gold	The Spanish established missions, which eventually collapsed because of the deaths of American Indians from disease and from slave raids by English traders.
French	1500s	To claim land in the Southeast and find resources to trade	Although the French managed to establish colonies north and south of Georgia in South Carolina and Florida, both colonies were short-lived.
British	1600s	To find deerskins and other items to trade, claim land in the Southeast, and limit Spanish influence in Florida	The British trade led to the disruption of American Indian societies in the Southeast.

Which conclusion can BEST be drawn from this chart?

- A. The Spanish supported French land claims in the Southeast.
- B. The Spanish had the least impact on the American Indians in the Southeast.
- C. The Spanish, French, and British all had economic interests in the Southeast.
- D. The Spanish, French, and British all wanted to bring their religion to the Southeast.

Item 4**Selected-Response**

Read the information in the box.

- Many American Indians converted to a new religion.
- American Indians allied themselves with various European groups.
- Many American Indians became ill from newly introduced diseases.
- American Indian economies responded to European demand for goods.

Which of these was the **MAIN** cause of the conditions listed in the box?

- A. the American Revolution
- B. the Spanish search for gold
- C. European exploration and colonization
- D. European involvement in the slave trade

Unit 4: Statehood

In this unit, you will study Georgia's history and how Georgia became a state. You will learn about important events in Georgia's past, such as the Battle of Kettle Creek, the invention of the cotton gin, the Dahlonega Gold Rush, the Trail of Tears, and the building of railroads. You will study famous battles of the American Revolution and learn more about key historical figures such as Andrew Jackson and John Marshall.

KEY TERMS

Articles of Confederation: The first constitution of the United States of America. Because it allowed for only a weak central government, it was later replaced with the U.S. Constitution, which established a federal government with a president, a judicial system, and the authority to tax. (SS8H3d)

Battle of Kettle Creek: A battle of the American Revolution fought in Georgia on February 14, 1779. The battle raised the morale of Georgia Patriots, gave them much needed supplies, and set the stage for several victories in the southern backcountry toward the end of the war. (SS8H3c)

Cherokee: A group of American Indians who lived in the southeastern United States, including Georgia, before being forcibly removed to reservations in Oklahoma on what would become known as the Trail of Tears. (SS8H4e)

Cotton gin: A machine that separates small particles, such as seeds, from cotton fibers. Its invention in the 1790s made cotton easier to process and cheaper to produce. It had a profound impact on Georgia, where cotton became a large and profitable industry, and it enabled the state to trade with not only other states but also other nations. Due to the cotton gin's effectiveness and the crop's profitability, slavery increased in Georgia and the Deep South. This led to the South's support and defense of the institution of slavery and later led to the Civil War. (SS8H4c)

Creek: A group of American Indians who lived in the southeastern United States, including Georgia, before being moved to reservations in Oklahoma. The Creek chief William McIntosh supported the efforts of the U.S. government to obtain Creek land. (SS8H4d)

Dahlonega Gold Rush: A rapid increase of settlers to Georgia sparked by the discovery of gold near the town of Dahlonega. It spread throughout the state and onto land given to American Indian groups as part of a treaty. Land seized from the Creek and Cherokee for the white settlers eventually led to the removal of the Indians on what would become known as the Trail of Tears. (SS8H4e)

Georgia's state constitution: A document that divides Georgia's government into three branches: the legislature, which is bicameral (two houses); the judiciary, which is made up of the state supreme court and lower courts; and the executive, which is presided over by the governor. Checks and balances among the branches prevent any one branch from becoming too powerful. (SS8CG1a, b)

Headright system: A system in which up to 200 acres of land were granted to people willing to voyage from Great Britain or from other colonies to settle in Georgia colony. Georgia employed the system in an effort to grow its population. (SS8H4b)

Andrew Jackson: The president of the United States during the Georgia Gold Rush. He ordered the Cherokee and Creek off Georgian land granted to them by a treaty with the U.S. government. This action led to the removal of the American Indians on what would become known as the Trail of Tears. (SS8H4e)

Land lotteries: A system employed by the state of Georgia in the early 1800s in which some citizens could register to win land previously held by the Cherokee and the Creek. (SS8H4b)

Loyalist: A colonist who remained loyal to the British government during the American Revolution. (SS8H3c)

John Marshall: The chief justice of the U.S. Supreme Court at the time of *Worcester v. Georgia*. (SS8H4e)

William McIntosh: A controversial Creek chief who supported the United States in its efforts to take Creek land. (SS8H4d)

Patriot: A person who supported breaking from the British government and forming a new government ruled by colonists. (SS8H3c)

Railroad: A means of transporting people and goods that made interstate commerce easier and more profitable beginning in the mid- to late 1800s. (SS8H4c)

John Ross: A chief who presided over the Cherokee during their migration from Georgia to Oklahoma on what is commonly known as the Trail of Tears. (SS8H4e)

Siege of Savannah: A battle of the Revolutionary War that took place in 1779. It was the second-deadliest clash of the war. The British maintained control of Savannah at the end of the siege. (SS8H3c)

Signers of the Declaration of Independence: Button Gwinnett, Lyman Hall, and George Walton were the three Georgians who signed the Declaration of Independence. Gwinnett was a British-born colonist who served in the colonial legislature and the Second Continental Congress. Hall served in the Second Continental Congress and as governor of the state of Georgia. Walton also served as governor of Georgia. (SS8H3b)

Trail of Tears: The route along which various American Indian groups were forced to walk from the Southeast to reservations west of the Mississippi. (SS8H4e)

University of Georgia: A university created by the General Assembly in 1785. It was the first university in the United States to be created by a state government and it later became a land-grant institution. The founders believed that educated citizens were important to a democratic society, that education should be available to all people, and that the government had a role in providing education. (SS8H4a)

Worcester v. Georgia: The case in which the U.S. Supreme Court ruled that states could not make or enforce laws dealing with American Indian groups, reserving such authority for the federal government. (SS8H4e)

Yazoo land fraud: The controversial sale of land by the governor of Georgia and the state's legislature during the mid-1790s. Tracts of land in what would become Mississippi and Alabama were sold cheaply to political supporters. Though reformers later passed a law nullifying the sales, the U.S. Supreme Court overruled the law. (SS8H4b)

KEY IDEA

The American Revolution

In the 1750s, conflict between the British and the French over control of North America escalated. The result was a war, known as both the Seven Years' War and the French and Indian War, that lasted from 1754 to 1763. Ultimately, British victories forced the French to sign over much of their territory.

Following the war, King George III signed the Proclamation of 1763, which forbade British colonists from settling west of the Appalachian Mountains. The settlers were unhappy with this, and their discontent grew when the king passed various acts to recoup the costs Britain had incurred during the war. These included the Stamp Act of 1765, which was the first British tax levied directly on American colonists. Every newspaper, pamphlet, and legal document had to include a British seal that was taxed. The Intolerable Acts were passed by Parliament to punish the colonies after the Boston Tea Party. These laws forced American colonists to quarter, or house, British soldiers in their homes and allowed royal officials accused of crimes to be tried in Britain rather than America.

In response, a group of leaders in the colonies formed the Continental Congress. They formally declared their independence from Britain in 1776 in a document known as the Declaration of Independence. They sent the document to King George III, who rejected it. War broke out, the colonists won, and the United States of America became an independent nation. (SS8H3a)

Sample Items 5–6

Item 5

Selected-Response

What was one reason for the Siege of Savannah during the American Revolution?

- A. to end the colonial boycott of British products
- B. to end the British military occupation of the city
- C. to force Savannah Loyalists to support the independence movement
- D. to force Savannah businesses to provide military support to the Patriots

Item 6

Selected-Response

How did the development of the cotton gin influence the economy of Georgia?

- A. The planting of cotton became quicker, leading to an increase in farm workers' wages.
- B. Cotton mills in the state became more efficient, helping the South to industrialize.
- C. Cotton could be processed much faster, leading to an increase in demand for slave labor.
- D. Southern plantations moved their cotton swiftly to northern factories, raising the price of cotton.

Unit 5: The Civil War

In this unit, you will study the Civil War period of history. You will learn about the passage of constitutional amendments and some major battles of the Civil War. You will read about many key events, including the Compromise of 1850, the Dred Scott decision, the Emancipation Proclamation, Sherman's March to the Sea, and tenant farming.

KEY TERMS

Andersonville: A small town in southwest Georgia known for its Confederate prisoner-of-war camp. (SS8H5b)

Chickamauga: The largest battle fought in the state of Georgia. The battle lasted three days and was the second-bloodiest battle of the Civil War. This was the largest Union defeat in the west. (SS8H5b)

Civil War: The name of a war fought in the United States between the Northern industrial states and the Southern agricultural states (which had seceded over the issue of slavery and states' rights). It lasted from 1861 to 1865. (SS8H5a)

Compromise of 1850: A federal compromise between anti-slavery and pro-slavery forces. It allowed each new state to determine its own status as a free or slave state when entering the Union. It also resulted in California joining the Union as a free state and the passage of the Fugitive Slave Act. (SS8H5a)

Debate over secession: Even within the Southern states, there was much debate over whether leaving the Union was constitutional. Ultimately, Georgia voted to secede. (SS8H5a)

Dred Scott: A slave who, on the basis of having lived in free states, sued for his freedom in federal court. The U.S. Supreme Court ultimately decided that, as "property," he had no right to sue. The court also declared parts of the Missouri Compromise unconstitutional because they deprived slave owners of their property. (SS8H5a)

Election of 1860: A presidential election that focused on the issue of slavery. Abraham Lincoln, the Republican nominee, opposed slavery, though he promised not to abolish the institution. When he won, however, a number of Southern states voted to secede from the Union. (SS8H5a)

Emancipation Proclamation: An executive order issued by President Abraham Lincoln on January 1, 1863, in the midst of the Civil War, declaring an end to slavery in those states that had seceded from the Union. (SS8H5b)

Freedmen's Bureau: A government agency established to help former slaves and poor whites in the South after the Civil War. It helped former slaves adjust to their new freedoms and responsibilities. (SS8H6c)

Georgia Platform: A statement issued by the Georgia Convention in response to the Missouri Compromise, affirming state acceptance of the Compromise. (SS8H5a)

Ku Klux Klan: A secretive, violent organization of white supremacists that arose after the Civil War to restrict the rights of African Americans/Blacks. (SS8H6c)

Nullification: The failure or refusal of a state to follow or enforce a federal law. A constitutional crisis was created when the state of South Carolina passed an ordinance declaring that two federal tariffs would not be observed. (SS8H5a)

Reconstruction: A period of rebuilding the country after the Civil War, during which the former Confederate States were governed under strict regulations before being readmitted into the Union. (SS8H6b)

Sharecropping: An institution of labor in which laborers agree to exchange labor and a portion of their crops to a land owner in return for land to work. Though sharecropping and tenant farming were similar, there was a major difference. Tenant farmers usually owned their own tools, animals, and other equipment, while sharecroppers brought only their labor into the agreement. (SS8H6e)

Sherman's Atlanta Campaign: A series of battles fought in Georgia after Union General William T. Sherman invaded the state in an attempt to weaken the South. (SS8H5b)

Sherman's March to the Sea: The movement of General William T. Sherman's Union forces from Atlanta, Georgia, to the port of Savannah, resulting in the capture of the port. The march destroyed much of the Confederate army's infrastructure, support, and trade routes. (SS8H5b)

Slavery: The ownership and forced labor of one person by another. In the early history of the United States, many Black men and women were enslaved in the South. Tensions between anti-slavery forces and pro-slavery forces led to the American Civil War. (SS8H5a)

States' rights: The idea that each state can pass laws without federal involvement. In the decades leading up to the Civil War, most Southerners saw slavery as a states' rights issue. (SS8H5a)

Tenant farming: A system, prevalent in the South after the Civil War, in which landowners allowed farmers to cultivate their land for a percentage of the profits and/or rent and food. Though sharecropping and tenant farming were similar, there was a major difference. Tenant farmers usually owned their own tools, animals, and other equipment, while sharecroppers brought only their labor into the agreement. (SS8H6e)

Union blockade: A strategy by the Union navy to prevent the South from trading its goods with Europe. (SS8H5b)

13th Amendment: An amendment to the U.S. Constitution that ended slavery in the states. (SS8H6a)

14th Amendment: An amendment to the U.S. Constitution that granted citizenship rights to all persons born in the United States. The amendment also declared that no state could make laws that took away rights of citizens. The amendment was ratified in 1868 to protect the rights of freed slaves after the Civil War. (SS8H6a)

15th Amendment: An amendment to the U.S. Constitution that guaranteed each individual's right to vote, regardless of race. (SS8H6a)

Sample Items 7–8

Item 7

Selected-Response

How did Sherman’s March to the Sea affect the state of Georgia?

- A. Sherman’s march diverted Union attention from Georgia, allowing the state’s militia to recover.
- B. The March to the Sea destroyed Georgia’s agriculture and roads, devastating the state’s economy.
- C. People in the state were proud that Georgia-born Sherman distinguished himself during the march.
- D. The March to the Sea was the first time the Union army actually entered the state of Georgia.

Item 8

Selected-Response

What was ONE reason whites removed African American/Black legislators from the Georgia General Assembly during Reconstruction?

- A. to end Jim Crow laws
- B. to gain political power
- C. to reinforce military rule
- D. to promote New South goals

Unit 6: The New South

In this unit, you will read about important people and events of the New South. The focus will be on the changes that occurred in Georgia between the end of the Civil War and the end of World War I. Many new businesses were developed by entrepreneurs as the South became more industrialized like the North.

KEY TERMS

Bourbon Triumvirate: A name for the three most powerful politicians of the post-Reconstruction era: John B. Gordon, Alfred H. Colquitt, and Joseph E. Brown. Two goals of the Bourbon Triumvirate were to promote the development of industry in Georgia and to maintain segregation. (SS8H7a)

Disenfranchisement: Being deprived of the right to vote. During the Jim Crow era, Georgia established laws such as poll taxes and literacy tests that prevented African Americans/Blacks and poorer whites from voting, leading to disenfranchisement. (SS8H7b)

W. E. B. Du Bois: A civil rights activist and author known for his opposition to the Atlanta Compromise, which called for African Americans/Blacks to accommodate whites in return for basic educational and economic opportunity. (SS8H7c)

Henry Grady: A journalist from Georgia. He was instrumental in the integration of Southern states back into the Union during the Reconstruction era. He is credited with introducing the term “the New South.” (SS8H7a)

Alonzo Herndon: Born into slavery, Alonzo Herndon was emancipated at the end of the Civil War. He went on to own many businesses, including barber shops in Atlanta and the Atlanta Life Insurance Company. (SS8H7c)

International Cotton Exposition: An event held in Atlanta in 1881 to showcase Atlanta as an industrial center and to promote investment in the state. (SS8H7a)

Jim Crow laws: Starting in the 1890s, Jim Crow laws, named after a fictional African American/Black minstrel character, took away most of the citizenship rights of African Americans/Blacks. Under these laws, most African Americans/Blacks could not vote or serve on juries and were denied many of the other rights of U.S. citizens. (SS8H7b)

Leo Frank: A Jewish man from Atlanta, Georgia, who was convicted of murdering a 13-year-old girl. He was believed to be innocent, and his conviction led to protests and even riots. Some attributed his conviction to prejudice because he was Jewish. After his murder by a lynch mob, the state of Georgia pardoned him. (SS8H7d)

Plessy v. Ferguson: A U.S. Supreme Court decision that upheld the “separate but equal” doctrine. The Court ruled that African Americans/Blacks had political rights under the 14th and 15th Amendments but that social rights were not required. According to the Supreme Court, as long as facilities were equal for both races, they could be separate. (SS8H7b)

Populists: Members of the Populist Party, or “People’s Party,” which formed in 1890 primarily to support resentful farmers and the working class against the interests of railroads, bankers, and corporations. The party gained substantial support among Georgia farmers in the late 1800s and early 1900s. (SS8H7a)

Booker T. Washington: An author and civil rights activist who supported the Atlanta Compromise, which called for African Americans/Blacks to accommodate whites in return for basic educational and economic opportunity. (SS8H7c)

Tom Watson: A writer from Georgia and a leader of the Populist Party of the United States, which sought greater protections for agricultural workers. (SS8H7a)

1906 Atlanta riot: In September of 1906, white mobs killed dozens of African Americans/Blacks and caused property damage in an Atlanta riot. The spark for the riot was a series of local newspaper reports (later proved to be untrue) of alleged assaults by African American/Black men on white women. Other causes of the riot included the large number of unemployed whites, who viewed African Americans/Blacks as threats to jobs and the established social order. (SS8H7b)

Sample Items 9–10

Item 9

Selected-Response

Which of these was an effect of the U.S. Supreme Court ruling in *Plessy v. Ferguson*?

- A. Many African Americans/Blacks became small-business owners.
- B. Many African American/Black youths were required to work in the fields.
- C. African Americans/Blacks were restricted from entering many public places.
- D. African American/Black students had access to a college education for the first time.

Item 10

Selected-Response

Read the list in the box.

The Bourbon Triumvirate

- Powerful political leaders in the post-Reconstruction era
- Developed railroad and mining industries
- ?

Which phrase **BEST** completes the list?

- A. Opposed to New South industrial growth
- B. Supported the desegregation of public schools
- C. Supported the interests of former plantation owners
- D. Reformed the state prison system to end convict labor

Unit 7: The 20th Century

In this unit, you will read about events that happened in the 20th century. These include a drought, the Great Depression, and World Wars I and II. You will learn about the invention of aircraft, the destruction by the boll weevil, the lend-lease program, and the Savannah and Brunswick shipyards.

KEY TERMS

Agricultural Adjustment Act: A federal law passed in 1933, ruled unconstitutional, and then modified and passed again in 1938. It set quotas on farm produce in an attempt to keep farmers in business during the Great Depression. (SS8H8e)

Bell Aircraft: A corporation that manufactured aircraft, including the B-29, and was active during World War II. (SS8H9b)

Boll weevil: A beetle that feeds on flowers and cotton buds. Not native to the United States, it proved disastrous to cotton producers in the American Southeast, including those in Georgia, during the Great Depression. (SS8H8b)

Civilian Conservation Corps: A Great Depression-era work relief program that put young American men to work in rural areas. (SS8H8e)

Drought: A period of little or no rainfall. A widespread drought in the United States during the 1930s created the Dust Bowl in parts of the Midwest and West. (SS8H8b)

The Great Depression: A sustained period of American economic decline. It lasted from 1929 until the mid-1940s. U.S. entry into World War II led to the end of the Great Depression. (SS8H8b)

Lend-Lease Act: The Lend-Lease Act in 1941 let the United States aid the Allies in World War II. It was signed by President Franklin Delano Roosevelt, and it allowed the United States to provide aid to Great Britain. (SS8H9a)

Military bases: Georgia provided more military bases for World War I than any other state. These bases included Fort McPherson, Camp Gordon, Camp Benning, and Camp Stewart. (SS8H8a)

New Deal: A series of laws enacted by President Franklin Delano Roosevelt during the Great Depression, aimed at rebuilding the American economy. (SS8H8e)

Pearl Harbor: A naval base in Hawaii that was attacked by Japan on December 7, 1941, prompting the United States' entry into World War II. (SS8H9a)

Franklin Delano Roosevelt: The president of the United States from 1933 until his death in 1945. He governed the nation during both the Great Depression and World War II. He first visited Brunswick, Georgia, in 1913 on business for the U.S. Navy. After contracting polio in 1921, he returned to the state, this time to visit Warm Springs, where he hoped the waters would restore him to health. He later purchased a home there, visiting often, and it was to become the site of his death. (SS8H8d)

Rural Electrification Administration: A federal agency established by the Rural Electrification Act, which was signed into law by President Franklin Roosevelt in 1936 to bring electricity to rural areas throughout the United States. (SS8H8e)

Richard Russell: Former governor of Georgia and U.S. senator. He was known for working to strengthen national defense as well as for opposing civil rights. (SS8H9c)

Savannah and Brunswick shipyards: Two deepwater ports in Georgia where ships were built. Both were extremely important to the United States during World War II. (SS8H9b)

Social Security Administration: It provides an income to elderly people who can no longer work by giving them benefits based on what they paid into the system while working. (SS8H8e)

Eugene Talmadge: A three-term governor of Georgia who served in the 1930s and 1940s. (SS8H8c)

Carl Vinson: A Georgia native who served in the U.S. House of Representatives. He was the first to hold congressional office for a period of 50 years. He is known as “The Father of the Two-Ocean Navy.” (SS8H9c)

World War I: Known at the time as the Great War, this war was largely fought in Europe, Africa, and parts of Asia. Georgia contributed more than 100,000 men and women to the war effort. (SS8H8a)

World War II: The largest war in history. Conflict extended into Europe, Africa, Asia, and both the Pacific and Atlantic Oceans. (SS8H9a)

Sample Items 11–13

Item 11

Selected-Response

Which group of people was MOST affected by the boll weevil in the years between World War I and World War II?

- A. cotton farmers
- B. factory workers
- C. railroad workers
- D. government officials

Item 12

Selected-Response

How was Georgia significant in the life of President Franklin Delano Roosevelt?

- A. President Roosevelt traveled to Warm Springs frequently to recover from complications of polio.
- B. President Roosevelt used his Warm Springs home as his military headquarters during World War II.
- C. President Roosevelt tested his New Deal programs in Georgia before spreading them across the country.
- D. President Roosevelt received support from Georgia Governor Eugene Talmadge to implement New Deal programs.

Item 13**Multi-Select Technology-Enhanced**

Read the information in the box.

The Civilian Conservation Corps (CCC), a public work relief program, was part of the New Deal. Operating between 1933 and 1942, it employed young men to work on conservation projects around the country. Its goals were to provide jobs for young men who had trouble finding work, to provide financial relief for their families, and to develop and conserve natural resources in public rural areas.

Which type of evidence would **BEST** help determine whether the CCC had been successful in meeting the goals listed in the passage? Select **TWO** responses.

- A. maps showing locations of CCC camps
- B. letters to family written by CCC participants
- C. legislation authorizing the creation of the CCC
- D. records showing the number of CCC participants
- E. posters encouraging men to apply to join the CCC
- F. estimates of the value of CCC improvements to public lands

Unit 8: Post–World War II Georgia

In this unit, you will learn about Georgia after World War II. You will study the rise of agriculture, the growth of businesses, and the importance of transportation. You will also learn about the capital, Atlanta.

KEY TERMS

Agriculture: The science of farming. It is an important part of Georgia’s economy. During the Civil War, cotton was the state’s leading product and was shipped to ports around the world. Today, the state is the world’s leading producer of pecans. It continues to produce cotton and is a major world supplier of peaches, peanuts, rye, and tobacco, as well as poultry and eggs. (SS8H10a)

Ivan Allen Jr.: The two-term mayor of Atlanta during the civil rights era of the 1960s. He opposed segregation and helped revitalize the city’s economy. (SS8H10b)

Atlanta: The capital of and largest city in Georgia, founded in 1837. It is the ninth-largest metropolitan area in the United States, and its economy is the tenth largest in the nation. (SS8H10b)

Entrepreneurship: The process of starting and organizing a business. The economies of many countries are supported by small businesses begun by entrepreneurs who were willing to take risks to start businesses. (SS8E2a, b)

Governor’s Race of 1946: In 1946, Georgia’s governor-elect, Eugene Talmadge, died before taking office. The General Assembly voted his son, Henry Talmadge, into office. The newly elected lieutenant governor, Melvin Thompson, however, insisted that he was the new governor. The Georgia Supreme Court ultimately ruled that Thompson was the rightful acting governor until a special election could be held to replace the elder Talmadge. (SS8H10c)

William B. Hartsfield: The two-time mayor of Atlanta who helped develop the city’s airport into the major transportation hub it has become today. He also worked with civil rights leaders during the Civil Rights Movement. (SS8H10b)

White primary: Primary elections in which only whites were allowed to vote. In 1944, the U.S. Supreme Court ruled them unconstitutional, and most Southern states ended the practice. (SS8H10c)

KEY IDEA

Transportation in Georgia

Georgia is a major transportation hub. The state capital, Atlanta, is one of the nation’s leading railroad centers. The city also has one of the nation’s largest airports, Hartsfield-Jackson Atlanta International Airport, which has been considered the busiest passenger airport in the world since 1998.

Georgia also has two of the nation’s busiest deep-water ports at Savannah and Brunswick. Between the years 2000 and 2005, Savannah was the nation’s fastest-growing seaport. The port at Brunswick is equally important and was once known as “The Shrimp Capital of the World.”

The state is also home to a number of important highways that connect Atlanta to other parts of the nation. Among them is I-75, which connects Michigan to Florida while going through a number of important cities. (SS8E1a)

Sample Items 14–16

Item 14

Selected-Response

How did changes in Georgia’s agriculture during the second half of the 20th century affect the distribution of the population in the state?

- A. New agricultural practices were developed, leading more people to move to rural areas.
- B. Many small farms were consolidated into larger farms, causing thousands of farmers to move to the cities.
- C. Severe droughts reduced the productivity of farms, forcing farm workers to move to cities and suburbs.
- D. New cotton mills were built as a result of the increase in cotton production, forcing people to move near the mills.

Item 15

Selected-Response

What was ONE way Mayor William B. Hartsfield helped the development of Atlanta?

- A. He brought several major league sports teams to the city.
- B. He helped implement peaceful integration of the city schools.
- C. He promoted the development of a commuter rail line in the city.
- D. He established affirmative action programs for hiring city contractors.

Item 16**Multi-Part Technology-Enhanced**

Examine the graph.

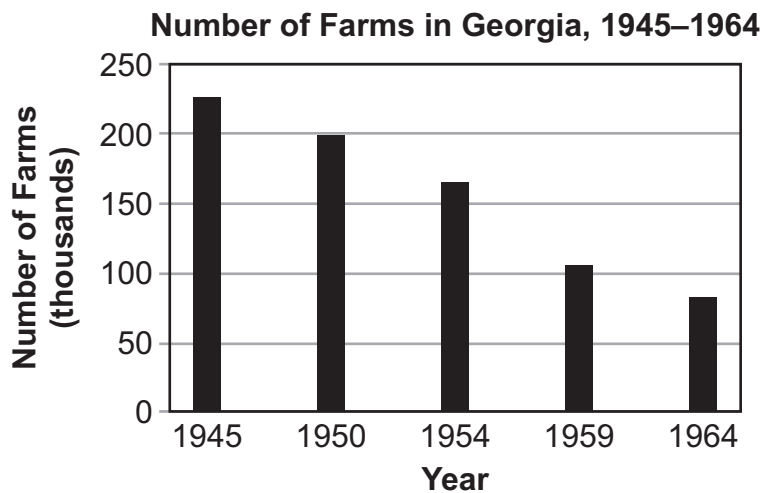

Source: U.S. Department of Agriculture

Part A

What was **MOST LIKELY** a major cause of the trend shown on the graph?

- A. the slowed growth of suburbs
- B. an infestation of agricultural pests
- C. the continuation of a long-term drought
- D. an increased use of agricultural technology

Part B

Based on the graph, which conclusion can **BEST** be made about Georgia between 1945 and 1964?

- A. There was a shortage of farm workers in the state.
- B. There was a population shift to urban areas of the state.
- C. There was a surge of immigration to rural areas of the state.
- D. There was a decreased demand for farm products in the state.

Unit 9: Civil Rights

In this unit, you will learn about the Civil Rights Movement and some of its leaders. You will learn about a landmark court case and the March on Washington. You will read about Martin Luther King Jr., John Lewis, and Lester Maddox.

KEY TERMS

Albany Movement: A partnership of the Student Nonviolent Coordinating Committee (SNCC), the National Association for the Advancement of Colored People, and activists from Albany, Georgia, that worked to end segregation. (SS8H11b)

Brown v. Board of Education: A landmark 1954 case in which the U.S. Supreme Court ruled “separate but equal” and race-based segregation of public school students to be unconstitutional. (SS8H11a)

Civil Rights Act of 1964: Ended segregation in public places and banned employment discrimination on the basis of race, color, religion, sex, or national origin. The Act was signed into law by President Lyndon B. Johnson. (SS8H11c)

Civil Rights Movement: A national movement undertaken by African Americans/Blacks and their supporters in the 1950s and 1960s to end segregation and ensure equal rights for minorities. (SS8H11b)

Martin Luther King Jr.: African American/Black civil rights leader of the 1950s and 1960s, from Atlanta, who opposed segregation. He believed in nonviolence and organized the March on Washington. He received a Nobel Peace Prize in 1964. He was assassinated on April 4, 1968. Martin Luther King Jr. Day is a federal holiday honoring his date of birth. (SS8H11b)

John Lewis: A civil rights leader who was chairman of the Student Nonviolent Coordinating Committee (SNCC) and organized the 1963 March on Washington. He has served as a U.S. Representative for Georgia’s 5th congressional district since 1987. (SS8H11b)

Lester Maddox: A segregationist who rose to fame after refusing to serve African Americans/Blacks in his restaurant. After a long legal battle, Maddox closed his restaurant rather than desegregate it. He later became governor of Georgia and softened his views on civil rights. His administration saw improved conditions for minorities in the state, and he later served as lieutenant governor under Jimmy Carter. (SS8H11c)

March on Washington: On August 28, 1963, approximately 250,000 people, mostly African American/Black, gathered before the Lincoln Memorial in Washington, DC, to demand equal protection under the law for African Americans/Blacks. It was at this event that Martin Luther King Jr. gave his famous “I Have a Dream” speech. (SS8H11b)

Sibley Commission: A commission charged by Governor Ernest Vandiver Jr. with studying segregation in the state of Georgia. The commission laid the groundwork for the end of state resistance to forced integration. (SS8H11a)

Southern Christian Leadership Conference (SCLC): A partnership of civil rights organizations and churches that worked for desegregation and other civil rights. The SCLC, led by Martin Luther King Jr. promoted nonviolent direct action to meet its goals. (SS8H11b)

Student Nonviolent Coordinating Committee (SNCC): An organization formed in 1960 to further the cause of equal rights for minorities. It is most famous for organizing sit-ins at universities, and freedom rides into the South. (SS8H11b)

Sample Item 17

Item 17

Selected-Response

What was a major effect of the March on Washington?

- A. It led to the creation of the Sibley Commission.
- B. It led to the president enacting most of the marchers' demands.
- C. It helped many of the march's leaders to win political campaigns.
- D. It created momentum for the passage of the Civil Rights Act of 1964.

Unit 10: Modern Georgia

In this unit, you will learn about modern-day Georgia. You will learn about the development of Atlanta under mayors Maynard Jackson and Andrew Young. You will learn about the Olympic Games of 1996, and you will study President Jimmy Carter and his many contributions to the state and the nation. You will also learn about Georgia's role in the national and global economy of the 21st century.

KEY TERMS

Maynard Jackson: First African American/Black mayor of Atlanta and of a major southern city. He served three terms. (SS8H12a)

Olympic Games of 1996: Held in Atlanta, Georgia, the Summer Games brought international attention to the state. The Games are estimated to have brought over \$5 billion into the city of Atlanta. The economic boost resulted in improved housing, sidewalks, and roads and in the construction of new sports venues in the city. (SS8H12c)

Transportation: Today, there are four major systems of transportation in Georgia that work together to move goods throughout the state, the nation, and the world. These are the interstate highway system, Hartsfield-Jackson Atlanta International Airport, Georgia's deep-water ports, and the state's railroads. All four systems enable goods to enter and leave the state with relative ease. (SS8E1a)

Andrew Young: An African American/Black minister and activist from Georgia who served as a representative for Georgia's 5th District, mayor of Atlanta, president of the National Council of the Churches of Christ in the USA, and U.S. ambassador to the United Nations. (SS8H12a)

KEY IDEAS

Jimmy Carter

Georgia native Jimmy Carter began his career in the U.S. Navy. After leaving the military, Carter, by then married and with three children, took over the family peanut farm.

In 1962, Carter jumped into local politics. He ran for the state senate, losing at first. He challenged the results, and when they were revealed to have been illegally tampered with by a local sheriff, another vote was held and Carter won.

After running for governor and losing, Carter returned to farming. Four years later, he again ran for governor, but this time he won. Carter's major accomplishments as governor include reorganizing state government; improving Georgia's educational, justice, and mental health systems; and appointing many women and minorities to governmental positions.

In 1976, Carter threw his hat into the presidential ring. A relative unknown at first, he became the frontrunner by mid-March of that year. In November, he won the election against incumbent president Gerald Ford with 50.1% of the vote. His presidency proved controversial, but he did oversee the creation of over 10 million jobs. Additional achievements as president include the Camp David Accords between Egypt and Israel and the Strategic Arms Limitation Treaty (SALT II) with the Soviet Union.

Despite losing reelection to Ronald Reagan in a landslide in 1980, Carter has kept busy in his later years. In addition to teaching, lecturing, and writing multiple books, he established the Carter Center in Atlanta in 1982. The purpose of the center is to fight human rights abuses, human trafficking, and disease worldwide. In 2002, he was awarded the Nobel Peace Prize. He is one of only four presidents to win the prize and the only one to do so for work not related to his presidency. (SS8H12b)

Georgia's Role in the National and Global Economy

Georgia has a key role in the national and global economy of the 21st century. Three of the state's top industries are tourism, shipping, and film production. Tourism, from domestic and foreign visitors, recently produced an economic impact of \$59 billion, supported over 400,000 jobs, and generated \$3 billion in tax revenue for the state.

Savannah is the fastest-growing container port and handles millions of container units for thousands of U.S. businesses. Construction is currently underway for an expansion of the port to accommodate larger vessels, thus increasing Georgia's role in domestic and international trade.

The film industry also contributes significantly to the global economy: Georgia ranks third in the nation for film and television production, creating a \$7 billion impact in 2016. Financial incentives, industry professionals, diverse film locations, and numerous other support services contribute to this rapid growth. (SS8H12d)

Sample Items 18–19

Item 18

Selected-Response

How has Jimmy Carter contributed to the area of human rights?

- A. He worked for human rights as a constitutional lawyer in Georgia.
- B. He drafted human rights legislation when he was Georgia’s governor.
- C. He rescued victims of human rights abuses when he was a naval officer.
- D. He helped build democracies that protect human rights after his presidency.

Item 19

Selected-Response

Which Atlanta event contributed MOST to making it an “international city”?

- A. hosting the Olympic Games
- B. sponsoring jazz music festivals
- C. supporting the Civil Rights Movement
- D. building a public transportation system

Unit 11: State and Local Government

In this unit, you will focus on the state and local government systems. You will learn about laws and the separation of powers. You will study the justice system and the courts and learn something about criminal law and the state's constitution.

KEY TERMS

Executive branch: The branch of government tasked with enforcing the law. It is headed by the governor and includes the aspects of government that cover public safety, education, transportation, human resources, and economic development. It also includes state agencies and law enforcement. (SS8CG3a, b)

General Assembly: Georgia's legislative branch of government is bicameral, meaning it has two houses. Those two houses are the Georgia House of Representatives and the Georgia Senate. Each of the General Assembly's 236 members is elected directly by the people of his or her district and serves a two-year term. Each member must be a resident of the district that he or she represents, must have been a resident of the state for at least two years, and must be at least 25 years of age. The General Assembly includes committees that study and examine issues pertaining to bills before they are presented to the entire Assembly. The ultimate job of the Assembly is to craft the state's laws. (SS8CG2a, b, c, d)

Georgia's state constitution: The Georgia state constitution consists of a preamble, a bill of rights, articles, and amendments. It divides government into three branches: the legislature, which is bicameral; the judiciary, which is headed by the state supreme court; and the executive, which is presided over by the governor. Checks and balances among the branches prevent any one branch from becoming too powerful. (SS8CG1a, b)

Governor: The leader of the executive branch of state government. In Georgia, the governor is tasked with signing bills into law or vetoing them; appointing leaders to various state agencies; and overseeing the state's affairs in general. Candidates for governor must be at least 30 years old when taking office, must have been a U.S. citizen for 15 years, and must have been a resident of the state for at least 6 years. Each term is limited to four years, and individuals are limited to two consecutive terms. (SS8CG3a)

Judicial branch: The branch of government tasked with applying and interpreting laws in the state. It consists of the state Supreme Court, a Court of Appeals, Juvenile Courts, Superior Courts, and additional lower courts. (SS8CG4a, b)

Legislative branch: The branch of government tasked with creating laws for the state. It consists of the Georgia General Assembly. (SS8CG2a, c)

Lieutenant governor: As both the leader of the Senate and the second-in-command of the state, the lieutenant governor is a member of both the legislative and executive branches. He or she is elected by popular vote and reports to the governor. If the governor dies in office, the lieutenant governor assumes the role of governor for the remainder of the term. As president of the Senate, he or she guides bills through the General Assembly but does not vote on them. Each term is four years in length, and candidates must meet the same requirements as candidates for governor. Unlike the governor, the lieutenant governor can run for an unlimited number of terms. (SS8CG3a)

Local government: In Georgia, local government is divided between counties and cities. The counties are overseen by either a single commissioner or a committee of multiple commissioners, who are elected to terms lasting anywhere from two to six years. They hold both legislative and executive power. Cities are mostly governed by a mayor and a city council. (SS8CG6a, b)

Special purpose governments: Districts usually created by cities or counties as "city business improvement" districts. (SS8CG6a)

KEY IDEA**State Revenue**

State revenue is the money gathered by the state to pay its bills. This money can be collected through a sales tax charged to customers when they purchase a product, a federal grant given to the state for a specific purpose, personal income taxes collected from an individual from the money he or she makes in a year, and property taxes collected from individuals who own property. The money that is collected is then spent on such things as police officers, firefighters, judges, statewide officeholders, programs designed to benefit members of the state, and so on. (SS8CG2d)

Sample Items 20–22

Item 20

Selected-Response

Look at the list in the box.

<p>Some Powers of the Georgia Governor</p> <ul style="list-style-type: none">• veto legislation• enforce the state’s laws• oversee the executive branch• ?

Which power **BEST** completes the list?

- A. pass the state’s operating budget
- B. command the state’s military forces
- C. hold trials in civil and criminal cases
- D. vote on proposed constitutional amendments

Item 21

Selected-Response

Throughout much of its history, Georgia has had a mostly rural population. How has this affected the development of government in the state?

- A. It has concentrated power in city governments.
- B. It has increased the powers of county governments.
- C. It has increased government representation in urban areas.
- D. It has led to the creation of many special-purpose governments.

Item 22**Multi-Select Technology-Enhanced**

Civil law and criminal law have similarities and differences. Select the TWO statements that are true ONLY about civil law.

- A. Trials are held in superior courts.
- B. Juries can determine the outcome of a trial.
- C. A plaintiff brings a lawsuit against a defendant.
- D. A government brings charges against a defendant.
- E. A defendant can be sentenced to serve time in prison.
- F. A private party tries to settle a disagreement with another private party.

Unit 12: Adult and Juvenile Justice Systems

In this unit, you will learn about the adult and juvenile justice systems. You will read about civil and criminal law and the court system.

KEY TERMS

Adult criminal justice system: A system of law enforcement tasked with apprehending, prosecuting, defending, sentencing, and punishing adults who are suspected or convicted of committing crimes. (SS8CG4d)

Civil law: A body of laws that relates to the resolution of legal issues between private individuals which can involve money damages. (SS8CG4c)

Court system: Georgia's judicial branch is divided into trial and appellate courts overseen by a supreme court. Trial courts are concerned with cases that are tried; appellate courts hear appeals from those trial courts. Judges are chosen by voters in nonpartisan elections. Midterm vacancies are filled by the governor. One role filled by the judicial branch in Georgia is the interpretation of laws. Courts must sometimes decide whether a law meets the standards set by the state constitution. (SS8CG4a, b)

Criminal law: A body of laws that relates to criminal acts, which can involve the loss of rights and imprisonment. (SS8CG4c)

Delinquent behavior: A type of behavior committed by a juvenile (a person 16 years old or younger) that would be considered criminal if committed by an adult. Theft is an example of delinquent behavior. (SS8CG5a)

Juvenile justice system: A system of justice that treats juveniles differently than adults. It is controlled by the juvenile code and is administered by juvenile courts. (SS8CG5a, b, c)

Unruly behavior: A type of behavior committed by a juvenile that would not be considered criminal if committed by an adult. Truancy is an example of unruly behavior. (SS8CG5a)

Sample Items 23–24

Item 23

Selected-Response

Which right do all juveniles have when taken into custody?

- A. the right to a fair trial
- B. the right to be judged as an adult
- C. the right to have a jury of juvenile peers
- D. the right to a lesser sentence than an adult

Item 24

Selected-Response

Which action by a juvenile would be considered delinquent behavior under Georgia law?

- A. stealing from a store
- B. being out after curfew
- C. disobeying family rules
- D. being truant from school

Unit 13: Personal Finance

In this unit, you will learn about personal finance. You will read about income, budgets, saving, and the uses and risks of debt.

KEY TERMS

Credit: An arrangement to obtain money, goods, or services with a promise to pay later, usually with added interest. (SS8E3d)

Debt: An amount of money that is owed to an individual or institution. (SS8E3d)

Household budget: A finance plan that tracks a household's income and general living expenses. (SS8E3b)

Income: The money a person earns through work or investments. (SS8E3a)

Risk: The possibility of financial loss. People who invest in stocks or bonds, for example, run the risk of losing their invested money. (SS8E3d)

Savings: Money a person or institution sets aside. Money saved in a bank earns interest over time. (SS8E3c)

Sample Items 25–27

Item 25

Selected-Response

Which of these is an example of income?

- A. Ali buys a new pair of brand-name sneakers.
- B. Sam takes out a loan to pay for his tuition for college.
- C. Maria puts money into a savings account at her local bank.
- D. Timothy earns an hourly wage working at a fast-food restaurant.

Item 26

Selected-Response

Which phrase describes a significant risk associated with mishandling credit?

- A. paying more sales taxes
- B. paying higher interest rates
- C. receiving higher credit scores
- D. receiving more credit card offers

Item 27**Multi-Part Technology-Enhanced**

Read the information in the box.

Matt and Jenna are married. They each have jobs that allow them to pay their bills and save money each month. They would like to have children in the next few years.

Part A

Based on the circumstances described in the box, which type of debt would probably be the **MOST** reasonable for Matt and Jenna to incur?

- A. using a credit card to pay for an extended vacation
- B. getting a loan from a bank to buy a new sports car
- C. using a credit card to buy the latest personal electronics
- D. getting a loan from a mortgage company to purchase a home

Part B

What would be the **MOST LIKELY** risk to Matt and Jenna if they were to incur debt?

- A. having fewer job opportunities
- B. having to decline credit card offers
- C. being unable to save for emergencies
- D. being unable to establish a household budget

SOCIAL STUDIES ADDITIONAL SAMPLE ITEM KEYS

Item	Standard/ Element	DOK Level	Correct Answer	Explanation
1	SS8H1a	2	D	The correct answer is choice (D) circular houses made from interwoven sticks covered with mud. American Indians living in Georgia built wattle and daub houses, which consisted of a wood framework covered with mud or clay. Choices (A), (B), and (C) are not correct because they describe the shelters of Southwest Indians, Northwest Indians, and Plains Indians, respectively.
2	SS8G1c	2	C	The correct answer is choice (C) Coastal Plain. The Okefenokee Swamp is located in this region. Choices (A), (B), and (D) are the names of other Georgia regions.
3	SS8H1b	3	C	The correct answer is choice (C) The Spanish, French, and British all had economic interests in the Southeast. The conclusions in choices (A), (B), and (D) are not supported by the chart.
4	SS8H1c	2	C	The correct answer is choice (C) European exploration and colonization. Choices (A), (B), and (D) are incorrect because although some of the conditions listed in the box were caused by these events, only European exploration and colonization caused all of them.
5	SS8H3c	2	B	The correct answer is choice (B) to end the British military occupation of the city. Choice (A) is incorrect because there was no boycott of British products. Choice (C) is incorrect because, although Savannah, like most American cities, had both Loyalists and Patriots, the main objective of the siege was to end British occupation. Choice (D) is incorrect because this was not a goal of the Continental Army.
6	SS8H4c	2	C	The correct answer is choice (C) Cotton could be processed much faster, leading to an increase in demand for slave labor. Choices (A), (B), and (D) are incorrect because they are unrelated to the cleaning of cotton for the mills.
7	SS8H5b	2	B	The correct answer is choice (B) The March to the Sea destroyed Georgia's agriculture and roads, devastating the state's economy. Choices (A) and (C) are incorrect because Sherman was a Union general, not a Confederate general. Choice (D) is incorrect because the March to the Sea was not the first time that the Union army entered Georgia.

Item	Standard/ Element	DOK Level	Correct Answer	Explanation
8	SS8H6d	2	B	The correct answer is choice (B) to gain political power. Choice (A) is incorrect because the white legislators wanted to keep Jim Crow laws rather than end them. Choice (C) is incorrect because the white legislators were opposed to military rule. Choice (D) is incorrect because the removal of African American/Black legislators would not have had a specific effect on the goals of the proponents of the New South.
9	SS8H7b	2	C	The correct answer is choice (C) African Americans/Blacks were restricted from entering many public places. Choice (A) is incorrect because <i>Plessy v. Ferguson</i> enforced segregation and did not promote African American/Black business owners. Choice (B) is incorrect because African Americans/Blacks were not necessarily forced to work in the fields. Choice (D) is incorrect because African American/Black students attended college throughout the post-Civil War era.
10	SS8H7a	2	C	The correct answer is choice (C) Supported the interests of former plantation owners. Choices (A) and (B) are incorrect because the Bourbon Triumvirate supported the industrial growth of the “New South” as well as segregation. Choice (D) is incorrect because the Bourbon Triumvirate utilized convict labor in their own enterprises.
11	SS8H8b	2	A	The correct answer is choice (A) cotton farmers. Choices (B), (C), and (D) are incorrect because an insect that attacked cotton plants would not affect these populations as much as it would affect cotton farmers.
12	SS8H8d	2	A	The correct answer is choice (A) President Roosevelt traveled to Warm Springs frequently to recover from complications of polio. Choice (B) is incorrect because President Roosevelt spent most of the World War II years in the nation’s capital. Choice (C) is incorrect because although President Roosevelt conceived of some New Deal programs while visiting Georgia, the state was not a testing ground for its programs. Choice (D) is incorrect because Georgia Governor Talmadge was an opponent of President Roosevelt’s New Deal policies.
13	SS8H8e	3	D, F	The correct answers are choice (D) records showing the number of CCC participants and choice (F) estimates of the value of CCC improvements to public lands. Choices (A), (B), (C), and (E) are incorrect because although these pieces of evidence would provide information about the CCC and the program’s participants, they would not be especially useful in determining whether the CCC had been successful in meeting the goals listed in the passage.

Item	Standard/ Element	DOK Level	Correct Answer	Explanation
14	SS8H10a	2	B	The correct answer is choice (B) Many small farms were consolidated into larger farms, causing thousands of farmers to move to the cities. Choice (A) is incorrect as changes in agricultural practices led people to live in urban areas rather than in rural areas. Choice (C) is incorrect because droughts did not reduce agricultural productivity at this time or force farm workers to move to cities and suburbs. Choice (D) is incorrect because the growth of cotton decreased during this period.
15	SS8H10b	2	B	The correct answer is choice (B) He helped implement peaceful integration of the city schools. Choices (A), (C), and (D) are incorrect because these were accomplishments of other Atlanta mayors.
16	SS8H10a	3	D, B	<p>The correct answer for Part A is choice (D) an increased use of agricultural technology. Choice (A) is incorrect because urban and suburban areas grew during this time period. Choice (B) is incorrect because although the boll weevil did cause widespread damage to Georgia's farms, this occurred during an earlier time period. Choice (C) is incorrect because although drought did affect parts of the United States during the 1930s, this was not a cause of the reduction in farms in Georgia in the post-World War II period.</p> <p>The correct answer for Part B is choice (B) There was a population shift to urban areas of the state. Choice (A) is incorrect because many farm workers lost their jobs during this time period. Choice (C) is incorrect because any immigrants were more likely to move to urban areas where there were more jobs. Choice (D) is incorrect because although there were fewer farms, they were more productive and a growing population would have continued demand for farm products.</p>
17	SS8H11b	2	D	The correct answer is choice (D) It created momentum for the passage of the Civil Rights Act of 1964. Choice (A) is incorrect because the Sibley Commission's work took place before the March on Washington. Choice (B) is incorrect because demands for increased civil rights were not assured until the passage of the Civil Rights Act of 1964 under a new president. Choice (C) is incorrect because, while some of the leaders of the march did win political office, this was not the major effect of the march.

Item	Standard/ Element	DOK Level	Correct Answer	Explanation
18	SS8H12b	2	D	The correct answer is choice (D) He helped build democracies that protect human rights after his presidency. Choice (A) is incorrect because he never worked as a constitutional lawyer. Choice (B) is incorrect because he never drafted human rights legislation as governor. Choice (C) is incorrect because, although he served in the U.S. Navy, he did not rescue victims of human rights abuses.
19	SS8H12c	2	A	The correct answer is choice (A) hosting the Olympic Games. Choices (B), (C), and (D) are incorrect because although they are events associated with Atlanta, they did not have an international component.
20	SS8CG3a	2	B	The correct answer is choice (B) command the state's military forces. Choices (A) and (D) are incorrect because they are powers of the legislative branch. Choice (C) is incorrect because this is a power of the judicial branch.
21	SS8CG6a	2	B	The correct answer is choice (B) It has increased the powers of county governments. Choice (A) is incorrect because rural areas depended more on county governments than on city governments. Choice (C) is incorrect because rural areas did not result in an increase in urban representation. Choice (D) is incorrect because special-purpose governments are not necessarily associated with rural areas.
22	SS8CG4c	3	C, F	The correct answers are choice (C) A plaintiff brings a lawsuit against a defendant and choice (F) A private party tries to settle a disagreement with another private party. Choices (A) and (B) are incorrect because they are true about both civil and criminal law. Choices (D) and (E) are incorrect because they are true only about criminal law.
23	SS8CG5b	1	A	The correct answer is choice (A) the right to a fair trial. Choices (B) and (D) are incorrect because they are true only in some circumstances. Choice (C) is incorrect because juvenile cases are judged in the juvenile court and not by a jury of juveniles.
24	SS8CG5a	2	A	The correct answer is choice (A) stealing from a store. Choices (B), (C), and (D) are incorrect because these describe actions that are considered unruly rather than delinquent behavior under Georgia law.
25	SS8E3a	2	D	The correct answer is choice (D) Timothy earns an hourly wage working at a fast-food restaurant. Choice (A) is an example of spending. Choice (B) is an example of credit. Choice (C) is an example of saving.

Item	Standard/ Element	DOK Level	Correct Answer	Explanation
26	SS8E3d	2	B	The correct answer is choice (B) paying higher interest rates. Choice (A) is incorrect because mishandling credit is not associated with more sales taxes. Choice (C) is incorrect because mishandling credit would likely lower one’s credit score. Choice (D) is incorrect because people with poor credit usually receive fewer credit card offers.
27	SS8E3d	3	D, C	<p>The correct answer for Part A is choice (D) getting a loan from a mortgage company to purchase a home. Choices (A), (B), and (C) are incorrect because these are considered luxuries rather than needs.</p> <p>The correct answer for Part B is choice (C) being unable to save for emergencies. Choice (A) is incorrect because incurring debt does not necessarily result in fewer job opportunities. Choice (B) is incorrect because declining credit card offers is not considered a particular risk. Choice (D) is incorrect because incurring debt does not prevent someone from establishing a household budget.</p>

ACTIVITY

The following activity develops skills in Unit 5: The Civil War.

Standard: SS8H6c

Impact of Reconstruction

- I. Select one of the topics listed below:
 - a. Freed slaves
 - b. Plantation owners
 - c. White sharecroppers
 - d. Ku Klux Klan
 - e. Freedmen's Bureau

- II. Research the topic and note the following:
 - a. The status of this group before the Civil War
 - b. How the group was affected by the events of the Civil War
 - c. How Reconstruction has changed the group's life (in positive and/or negative ways)
 - d. How the group might feel about the changes Reconstruction brought to Georgia

- III. Imagine that you lived in 1876. Based on your research, write a letter to your local newspaper giving your opinion on whether Reconstruction should be ended in the South. Be sure to cite evidence (based on your research) on how Reconstruction has affected Georgia.

This activity could be adapted to different eras in Georgia history. Possibilities include the following:

- a. Georgia Exploration and British Colonization (American Indians, mission American Indians, Spanish, English, etc.)
- b. Revolution (American Indians, enslaved Africans, Loyalists, Patriots, British soldiers)
- c. Civil War (enslaved Africans, soldiers' wives and sisters, soldiers, generals, plantation owners)
- d. The New South (rural Georgians, urban Georgians, factory workers, sharecroppers, etc.)

ACTIVITY

The following activity develops skills in Unit 11: State and Local Government.

Standard: SS8CG1

Rights of Citizens

Identify various rights of the citizens of Georgia.

Read the Georgia Constitution, Article I, Section 1. Identify 7–8 rights that may particularly apply to you.

Remember that citizens have rights and responsibilities.

Write down each right in a chart similar to the one below. Then discuss with a family member or friend what these rights mean, and note the meaning in the right column.

Right	What it means

1. Choose a particular right from the 7–8 rights selected.
2. Write a paragraph describing the significance of that right in your life or the lives of people you know. For example, the right to freedom of speech and of the press might mean that a newspaper can publish an editorial about a government leader, Maria can state her opinion at a public meeting, and Parker can write about his ideas in an Internet blog.
3. Share what you wrote with a family member or friend and discuss whether there are other examples of the significance of that right.

APPENDIX A: LANGUAGE PROGRESSIVE SKILLS, BY GRADE

The following skills, marked with an asterisk (*) in Language standards 1–3, are particularly likely to require continued attention in higher grades as they are applied to increasingly sophisticated writing and speaking.

Standard	Grade(s)									
	3	4	5	6	7	8	9–10	11–12		
L.3.1f. Ensure subject-verb and pronoun-antecedent agreement.										
L.3.3a. Choose words and phrases for effect.										
L.4.1f. Produce complete sentences, recognizing and correcting inappropriate fragments and run-ons.										
L.4.1g. Correctly use frequently confused words (e.g., <i>to/too/two; there/their</i>).										
L.4.3a. Choose words and phrases to convey ideas precisely.*										
L.4.3b. Choose punctuation for effect.										
L.5.1d. Recognize and correct inappropriate shifts in verb tense.										
L.5.2a. Use punctuation to separate items in a series.†										
L.6.1c. Recognize and correct inappropriate shifts in pronoun number and person.										
L.6.1d. Recognize and correct vague pronouns (i.e., ones with unclear or ambiguous antecedents).										
L.6.1e. Recognize variations from standard English in their own and others' writing and speaking, and identify and use strategies to improve expression in conventional language.										
L.6.2a. Use punctuation (commas, parentheses, dashes) to set off nonrestrictive/parenthetical elements.										
L.6.3a. Vary sentence patterns for meaning, reader/listener interest, and style.†										
L.6.3b. Maintain consistency in style and tone.										
L.7.1c. Places phrases and clauses within a sentence, recognizing and correcting misplaced and dangling modifiers.										
L.7.3a. Choose language that expresses ideas precisely and concisely, recognizing and eliminating wordiness and redundancy.										
L.8.1d. Recognize and correct inappropriate shifts in verb voice and mood.										
L.9-10.1a. Use parallel structure.										

* Subsumed by L.7.3a

† Subsumed by L.9-10.1a

† Subsumed by L.11-12.3a

APPENDIX B: CONDITION CODES

Condition Codes (Non-Score)

A student response may receive a condition code in place of a score for various reasons. Students who receive a condition code (non-score) have a score of zero (0). The chart below explains the various condition codes that a student response may receive.

- For the extended writing tasks, both traits receive a score of 0. For Trait 1: Ideas, the score is 0 out of 4 possible points, and for Trait 2: Language Usage, the score is 0 out of 3 points. (Or the score is 0 points out of a possible 7 points.)
- For the narrative item, the score is 0 out of a possible 4 points.

Non-Score (Code)	Performance Scoring: Non-Score (Code) Description	Full Description
B	Blank	<ul style="list-style-type: none"> • Blank • Student's response did not contain words. • In some instances, student may have drawn pictures.
C	Copied	<ul style="list-style-type: none"> • Student's response is not his/her own work. • Student does not clearly attribute words to the text(s). • Student copies from the text(s) that serve(s) as writing stimulus.
I	Too Limited to Score	<ul style="list-style-type: none"> • Student's response is not long enough to evaluate his/her ability to write to genre or his/her command of language conventions.
F	Non-English/Foreign Language	<ul style="list-style-type: none"> • Written in some language other than English • The writing items/tasks on the test require the student to write in English.
T	Off Topic/Off Task	<ul style="list-style-type: none"> • Student may have written something that is totally off topic (e.g., major portion of response is unrelated to the assigned task). • Student response did not follow the directions of the assigned task (i.e., off task).
U	Unreadable/Illegible/Incomprehensible	<ul style="list-style-type: none"> • Response is unreadable. • An illegible response does not contain enough recognizable words to provide a score. • An incomprehensible paper contains few recognizable English words or it may contain recognizable English words arranged in such a way that no meaning is conveyed.
S	Offensive	<ul style="list-style-type: none"> • Student uses inappropriate or offensive language or pictures.

END OF GRADE 8
*EOG STUDY/RESOURCE GUIDE
FOR STUDENTS AND PARENTS*

Study/Resource Guide
for Students and Parents
Grade 8
End-of-Grade

