

MARINE CORPS

Junior Reserve Officers' Training Corps



LEADERSHIP EDUCATION I
STUDENT TEXT

LEADERSHIP
EDUCATION
STUDENT TEXT

I

LE-I TABLE OF CONTENTS

Leadership

Leadership Defined.....	1
The Leader Within	7
Leadership Primary and Secondary Objectives	11
Ethics, Morals, Values	15
Marine Corps' Core Values	21
Using Introspection to Develop Leadership Traits	27
Military Leadership Traits	31
The 11 Leadership Principals.....	41

Citizenship

Defining Patriotism.....	47
Rights, Responsibilities, and Privileges.....	51
Attaining Citizenship.....	57
Volunteerism.....	61
Getting Involved	

Personal Growth and Responsibility

Physical Training: The Daily Sixteen	65
The National Youth Physical Fitness Program	83
Personal Hygiene	93
Suicide Awareness and Prevention	107
Managing Your Stress.....	117
Drug and Alcohol Use and Abuse.....	127
Drug and Alcohol Abuse: Prevention and Intervention	139
Tobacco – Use and Effects	155
You Are What You Eat.....	165
Nourishing Your Body.....	171
Practicing Good Manners	187
Proper Table Manners.....	197
Effective Study Skills: Note-Taking and SQ3R	205
Communicating Effectively Through Writing.....	215
Becoming a Better Listener	223
Becoming a Better Speaker.....	229

Public Service and Career Exploration

Introduction to Career Preparation – The Portfolio 235

General Military Subjects

Introduction to MCJROTC Leadership Education 239

MCJROTC Unit Organization 247

Requirements for MCJROTC Participation 253

The Benefits for Successful Completion of MCJROTC 257

Promotions and Awards – Signs of Success 259

Codes of Conduct 265

Professional Personal Appearance 269

Introduction to MCJROTC Uniforms 275

Wear and Care of the Utility and Physical Training Uniforms 285

Wear and Care of the Service Uniforms 289

The Salute: A Sign of Respect 295

Rendering Salutations 299

Marines’ Hymn 303

A Symbol of Pride 307

Marine Corps Birthday 309

The United States Flag – Colors of Pride 311

Pledge of Allegiance 319

Marine Corps JROTC Rank Structure 323

Marine Corps Rank Structure 327

The Purpose of the Chain of Command 333

MCJROTC Unit Chain of Command 335

Marine Corps Chain of Command 339

From the Halls of Montezuma – The Marine Corps (1775-1848) 343

Growth in Size and Stature (1859-1918) 349

World War II and the Korean War 357

The Marines in the Modern Era 365

The History of Marksmanship 375

Firearm Safety and Safe Range Operation 381

Target Shooting Equipment and Its Operation 387

The Four Life Saving Steps 395

Heat Injuries 403

Treatment of Cold Weather Injuries 407

Leadership Defined

PURPOSE

This lesson explores the Marine Corps definition of leadership. Learning good leadership skills and becoming a successful leader are not easy tasks. With this introduction to leadership, you can begin to appreciate the characteristics that successful leaders exhibit to themselves, their team members, their supervisors, and their organization.

Introduction

Leadership is the art of influencing men and women to obtain their obedience, respect, confidence, and loyal cooperation. Good leadership develops through a never-ending process of self-study, education, training, experience, observation, and emulation. All cadets can sharpen their leadership abilities through a conscious effort of self-improvement.

Leadership in MCJROTC will give you the skills, confidence, and character necessary to become a good leader. In this lesson you will identify leader behaviors you have that are most appreciated when working with others toward accomplishing a task. You will link those behaviors to a definition of leadership and begin to assess your own leadership behaviors.

Definition

Leadership is the ability to influence, lead, or guide others to accomplish a mission in the manner desired by providing purpose, direction, and motivation.

Purpose gives others a reason for why they should do something.

Direction gives others the “knowledge” to complete the task.

Motivation gives others the will to do what they are capable of doing.

Purpose

A purpose gives people a reason to do things. This does not mean that as a leader you must explain every decision to the satisfaction of others. However, it does mean that you must earn their trust. They must know from experience that you care about them and would not ask them to do something unless there was a good reason, unless the task was essential to mission accomplishment. Trust is a basic bond of leadership, and it must be developed over time.

Direction

When providing direction, you communicate the way you want to accomplish the mission. It is accomplished by prioritizing tasks, assigning responsibility for their completion, and making sure your team members understand the standards. In short, you figure out how to get the work done right with the available people, time, and resources, then you communicate that information to your team members.

Motivation

Motivation gives others the will to do everything they can to accomplish a mission. It results in their acting on their own initiative when they see something that needs to be done. Leaders

motivate people by more than words. The example you set is at least as important as what you say and how well you manage the work.

Organizational Structures

Organizational structures consist of assigned leadership positions. These positions usually have others reporting to them. This structure is similar in team sports, scouts, church, schools, and government. It is a “chain of command” that is respected and followed.

Leadership and You

Are you a leader? Let’s return to the definition: The ability to influence others. Influence is defined as the power to control or affect others by authority, persuasion, or example.

Do you influence your parents? Your brothers or sisters? Do you influence members of a team in your school? Do you influence others in your church? Scouts? JROTC? Sure you do! You lead others every day in so many ways. And most often it is NOT because you have the authority. You lead by your behavior and by setting the example for your brothers and sisters. You persuade your friends to do something they had not thought possible. You even lead yourself. In fact, that is where leadership begins: WITHIN YOU!

Case Studies

Which leader behaviors do you possess right now? Which behaviors do you need to improve upon to become a good leader? Think about these two questions as you read the following case studies. They will give you the opportunity to see how three very different people used some leadership behaviors effectively,

ineffectively, or not at all. Read each case study carefully.

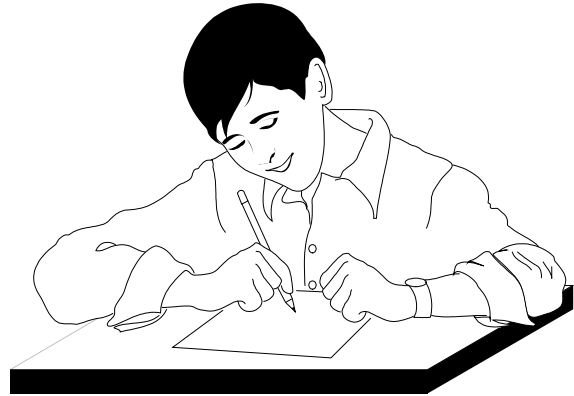

Case Study #1

Jon is normally an average student. However, when he takes charge of a group to complete a project, his work and the finished effort of the group are always outstanding.

When asked about his group’s results, his teammates proudly answered, “Jon makes it easy for us to complete our tasks. He helps us and makes suggestions when we need help, but he lets us do the work. If we have a problem, he always listens to our ideas on how to fix it.

“Because he is always excited about what he is doing, we get excited, too. He learns all he can about a task before we get started on it. While we are doing the task, he respects our views about how to complete it, he effectively uses the talents of everyone on the team, and he makes smart decisions. He is always there for us if we need him and, somehow, he still finds the time to do his share of the project. Because of his effective work habits, he instills good works habits in us.

“He accepts responsibility for the outcome of our tasks, whether they are good or bad. None of us wants a project to be done poorly, but he does not blame others for any mistakes that he or the team may have made. After finishing one

task, we are always glad to begin the next project under his direction.”

Would you like to be a member of Jon’s team? What are his desirable characteristics? What are his undesirable characteristics?

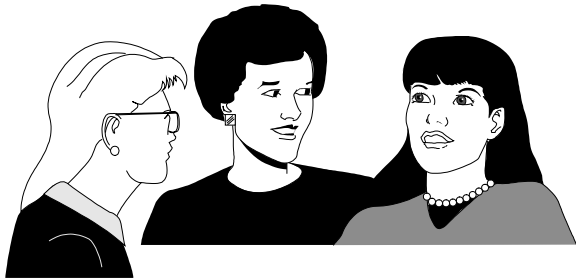

Case Study #2

Maria knows exactly what her position is all about. She gets excited whenever an instructor assigns her a project because she knows that she can get it done. Sometimes, she even suggests projects to her instructor. Based on her ideas, the instructor usually assigns them to her and her team.

Maria is highly motivated and has very structured work habits. She likes to map out a project in which everything is her decision. She then tells her team members how to do each step of their tasks according to her direction. She watches everything that her team members do, and if they appear to be doing a task differently from her plan, she criticizes them.

Once, Maria got upset when a teammate was caught cheating. At first, she was afraid to talk to that person about the incident, and she did not know what to say to her peers who had also heard about it. Finally, after asking herself how she would like to be treated if she were the one involved, she called a team meeting.

At the meeting, Maria informed everyone that all team members make mistakes, not only as

a team but also as individuals. She hoped that if they ever had any problems, they would turn to her and/or another team member for help. They agreed.

Would you like to be a member of Maria’s team? What are her desirable characteristics? What are her undesirable characteristics?



Case Study #3

Brian is an easy-going person. He wants to complete projects with plenty of time left so that he and his friends on the team can relax. After he assigns tasks to each of his team members, he lets them figure out the best way to complete the tasks—without giving them any help, direction, or supervision. He rarely makes any decisions.

Then, when the time comes to complete the project, he still turns it in even though parts of it are not finished. When the final grade comes back, his group makes the lowest mark in the class, prompting an instructor to ask, “Why wasn’t your project done?”

Brian passes the blame on to his team members by saying, “They didn’t complete their tasks like they should have. I don’t believe that I should have to be responsible for their sloppy efforts and receive a bad grade.”

When the other team members find out their grades, they approach Brian and say, “Why didn’t you tell us everything that we were supposed to do? We could have worked harder and done better if we had just known.”

Would you like to be a member of Brian’s team? What are his desirable characteristics? What are his undesirable characteristics?

Questions for Case Studies 1-3:

These case studies illustrate the positive and negative application of leadership behaviors. Do you possess any of them? What do you appreciate most about your leadership behaviors? Can you identify which behaviors you need to work on to become an effective leader? Would you like to change or add any of them? Can you identify any positive behaviors in other people that you would like to adopt? In the next case study, see if you can identify ways to add new leadership behaviors to your character.



Case Study #4

Jason North had an opportunity one day to visit his father at work. He noticed that his dad’s employees worked very hard for him. However, Peter, a mechanic who had worked on the assembly line for many years, seemed to resist

all friendliness or help from the others. He also avoided speaking to Mr. North most of the time.

That afternoon, while the other employees and Jason were present, Mr. North approached Peter. He asked him, “What do you think of us purchasing the MXR-78 to help increase the production of the assembly line?”

Peter answered, “Why are you asking me? I really don’t know much about it.”

Mr. North responded, “You have a lot of experience here and I would like you to find out if the MXR-78 would make the line run more efficiently. So, will you do this for me?” With urging from the others, Peter accepted.

Later that evening, Jason asked his dad, “Why did you ask Peter to do that job?” Mr. North replied, “Peter is a reliable and experienced employee. He just needed some individual recognition. So, I gave him that assignment to make him feel more a part of the team.”

Although the previous story is just one example that pertains to only several leadership behaviors, Jason can definitely learn from his father’s approach in dealing with Peter. A positive role model like Mr. North can be a powerful influence in one’s desire to adopt another person’s positive leadership behaviors.

Questions for Case Study 4:

What did you learn about influencing others? How effective do you think you are in influencing others? Are there some leadership characteristics you would like to adopt? Why?

Conclusion

Now is the time to begin identifying the leadership behaviors that you would like to possess. By adding new behaviors and/or

changing other behaviors, you can have a major influence on the development of your leadership potential. ❖

The Leader Within

PURPOSE

This lesson will help you develop your own personal definition of leadership by evaluating yourself, identifying the leadership behaviors that you desire most, and developing a plan for improvement of personal leadership behaviors.

The Study of Leadership

There have been a number of studies over the years directed at understanding effective leadership. The desire to assist people in the behaviors that effectively influence, lead, and guide others remains a highly regarded search.

The more you understand the behaviors that create the desire to follow, the more you will be able to determine the leadership behaviors that will work best for you. Even more important, the ones that do not.

Have you ever wondered how some leaders influence, excite, stimulate, and energize others? When you were influenced, excited, stimulated, or energized by someone else to do something you thought impossible? Do you reflect on those times so you could copy the behaviors you liked? Think of those teachers you remember most. What was it they did that made you remember them?

As researchers continue to study the characteristics of leaders and as the world we live in continues to change through technology and human growth, we are finding that one key ingredient to leading others successfully is the ability to successfully lead oneself. Leading from

the inside out is the foundation to building successful relationships in your family, church, community, and school.

What Guides Your Behaviors?

Beliefs, values, and norms guide the actions of individuals and groups. They are like a traffic control system; they are signals giving direction, meaning, and purpose to our lives. They are powerful. Experiences involving such things as family, school, church, work, and social relationships shape your individual values, beliefs, and attitudes. Understand the importance of nurturing and shaping these qualities in your followers because they are fundamental motivating factors.

Mutual respect between you and your team members motivates them to follow your orders. So, make it a general rule to think through situations and choose the course of action that will gain you the long-term respect of your followers, seniors, and peers. By earning their respect, you will be exerting your influence on their beliefs, values, and norms.

What Is Your Self-Image?

Leading from the inside out means to set examples and model the behavior that you want others to exhibit. By knowing what is important to you, you can make sure your actions are supporting the things you value most. You need to lead yourself before you can lead others.



Self-image is how you see yourself. It is what you think about your characteristics, your physical body, your morals and values, your needs and goals, and your dreams. Having a good self-image is being satisfied with and accepting what you see in yourself.

When you become a leader, you need to constantly be aware of how you see yourself. Be honest with yourself and try not to have illusions about what you are or what you would like to be. If you believe that you cannot do a task, or if you are not consistent with the values that you think you have, then you may begin to have doubts about yourself. Leaders who openly display doubt, hesitation, or uncertainty in their own abilities will likely cause their followers to have doubts about them and their ability to lead.

If what you see is not what you want to be, you can make changes. You can become the person you want to be. You will need to determine what is important to you and what you value most. If you begin to think positively about yourself, others will see your confidence and will want to follow you. Here are some things to remember as you begin to develop your self-image.

Focus on the Positive

One way to improve your self-image is to identify all of the positive qualities that you possess. A certain amount of emphasizing the positive is necessary to boost your own self-image. What do you like **MOST** about yourself? How can you do **MORE** of what you like most?

Self-disclosure

Self-disclosure is talking to others about you. As you talk to others, you will realize that your problems and shortcomings are no different from theirs. What do they like **MOST** about you? How can you do **MORE** of what they like most about you?

Making the Change

Once you identify the behaviors that you wish to have, then what? Think of ways to fit the behavior into your personality and into the way you want to lead. Use that skill whenever it is appropriate--practice will make it a part of your style.

On the other hand, changing a negative behavior into a positive one is not easy. It may be like breaking an old habit. Use the following steps to change a negative behavior:

1. Realize the need for change
2. Have a positive attitude toward the change
3. Follow through

Change is never easy, so keep trying. Just like other tasks, change requires dedication and perseverance. If you can perform a task a certain way and can see it through to completion, that positive behavior can become a lifetime habit.

Conclusion

As a leader, you are responsible for making decisions, but do not decide on a course of action without thinking over the consequences -- the choice you make should be based on your values. Then, apply these values to every leadership situation in order to build the trust and confidence of your followers. Finally, beware of temptations and pressures that can affect a leadership situation. Remember, anyone can make a decision, but effective leaders base their decisions on the highest moral good. Let your personal and professional codes of ethics guide you to do what is morally right. ❖

Leadership Primary and Secondary Objectives

PURPOSE

This lesson will explain to you the primary and secondary objectives of leadership as defined by the Marine Corps.

Introduction

The primary objective of leadership is **mission accomplishment**. Mission accomplishment is achieving your goal. Achieving your goal is your primary focus when asked to take on a task. The secondary goal of leadership is **troop welfare**. The welfare of your troops should always be a consideration for you as a leader. Both objectives go hand and hand in accomplishing any task.

In the MCJROTC program, these same objectives apply. You are expected to accomplish assigned missions and to take care of the cadets under your leadership. Accomplishing your primary and secondary objectives develops leadership.

Mission Accomplishment

Mission accomplishment means that you must know your job and do it well. You must know how to control and employ your unit under varied conditions. In military situations, leaders must be skilled in military sciences and in the use of weapons. Military leaders must ensure their troops know the basics: care and use of weapons and equipment; camouflage, fire and maneuver; cover and concealment; preparation of fighting

positions; use of supporting arms, land navigation, discipline, hand to hand combat; and other essentials on how to fight, survive and win.

In MCJROTC, mission accomplishment is also your primary objective. As a cadet you are given many different tasks that your instructor expects you to carry out properly. Examples include: executing drill movements properly, or completing your assignments in a timely fashion. It is your responsibility to accomplish these tasks.

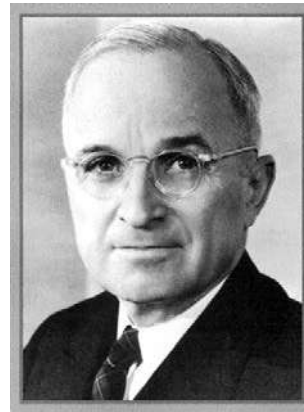

DID YOU KNOW?

President Harry S. Truman kept a plaque on his desk with the inscription “The buck stops here.” Truman was one of America’s most honest and ethical presidents. He never flinched from accepting responsibility for his decisions, however, unpopular or controversial.

Troop Welfare

The secondary objective of leadership is troop welfare. Marine leaders must know their Marines and take care of them. They must learn all they can about each Marine in their unit: their background, their problems, their strong and weak points, their military skills, their endurance, and their courage. This knowledge will help predict and influence their actions. It enables the Marine leader to make the most of each Marine's ability.

Leaders must put the needs of their troops before their own needs. They must instill a feeling of camaraderie and team spirit in their troops and a sense of trust in the leader.

In MCJROTC, the welfare of the cadets is of no less importance. In order to be the best, cadets must know that their leader is concerned about their welfare. Leaders, at every level, must make an effort to get to know the cadets they lead. No cadet is exempt. The leader must set the example and in doing so, will earn the trust and respect of their cadets.

BE a leader of character. Embrace the values and demonstrate the leader attributes. Study and practice so that you will have the skills to KNOW your job. Then act, DO what is right to achieve excellence.

Case Study

You are a newly promoted sergeant and the platoon leader just made you a squad leader. During your initial encounter with the members of your squad, you sense some resentment toward you as their "new" leader. The squad leader you replaced was popular with them, but the platoon

leader relieved him for failure to motivate the squad to achieve standards.

Your first assignment as squad leader is to fold the U.S. flag at a ceremony. While you are meeting briefly with the platoon sergeant, your squad departs for the football field to prepare for a rehearsal. During the meeting, the platoon sergeant tells you who in your squad has been on these details before.

As you approach the field, you see your squad relaxing. Instead of going straight into a rehearsal, you decide to have a few knowledgeable people demonstrate how to fold the flag.

You state to the squad that you are going to conduct a demonstration and for them to move into a circle. They don't move. You walk up to PFC Hart, whom the platoon sergeant said knows how to fold the flag, and he gives you a challenging stare as if to say, "I don't want to be a demonstrator." You ask him to come forward and take the flag. He says something disrespectful and still doesn't move.

This action infuriates you, but you control your emotions and remain calm. Your mind swiftly goes to work on the situation. This subordinate has challenged your authority and put you in a difficult position. He has given you a major disciplinary problem – disrespect and insubordination – before you have even had the opportunity to get to know your squad members and the informal norms of the squad. The way you handle this situation will have a major impact on the cohesion, discipline, and the respect these people will have for you.

Case Study Options

After identifying this challenge as one of how to take immediate action to gain control and maintain discipline while earning the long-term

respect of your subordinates, you consider the following alternatives:

- Reprimand PFC Hart in front of the squad, informing him that you will recommend him for an instructor's reprimand for his insubordination. If he continues to disobey, you will recommend that he be demoted.
- Stand directly in front of PFC Hart, look him in the eye, and order him to stand up and take the flag from you.



You quickly weigh the advantages and disadvantages of each course of action.

If you take the first course of action, you come across as decisive and strong and you immediately assert yourself as the authority. The disadvantage is that it is normally unprofessional to reprimand someone in front of others. In addition, it is never wise to tell a subordinate exactly what punishment you would recommend until you have had a chance to think the situation through and discuss it with your seniors.

If you take the second course of action, you would not be reprimanding PFC Hart in front of others – you could do that later in private. You would show your squad that you do not back

down from a challenge, and that you do not resort to threats in order to maintain discipline. Remember, you could still recommend punishment that you believe is appropriate later depending on PFC Hart's actions. The disadvantages are that you would not be immediately asserting yourself as the unquestioned authority, and that some of your subordinates might think they could get away with disrespectful and insubordinate behavior.

You quickly think through the actions you could take, including the use of possible contingencies. If you order PFC Hart to stand and take the flag and he does, continue with the demonstration; then order him and his team leader to meet you immediately after the rehearsal. If he refuses, inform him: (1) that he is being insubordinate and give him another order, and (2) by refusing your order, he will have committed two serious offenses. If he still refuses, immediately send for the platoon sergeant or platoon leader while you select other squad members to do the demonstration. This plan prepares you for possible contingencies if he finally obeys you or if he continues to disobey.

Depending on what PFC Hart does, take action in terms of your plan or make appropriate changes. Also, observe the effect of your actions on the manner and obedience of the other squad members. Explain that you will not tolerate insubordination and disobedience, and that you will always take suitable disciplinary action against those offenses.

You decide on the second course of action. Initially, some squad members do think that PFC Hart got away with his insubordination, but they discover otherwise when they find out that you sternly reprimanded him in the presence of his team leader, counseled him, and recommended him for additional punishment.

Conclusion

As MCJROTC cadets, it is important that you know and understand the primary and secondary objectives of leadership. These objectives are key to effective leadership. Remember, you must accomplish your mission but in doing so, you must also ensure that you are taking care of the cadets whom you lead. Understanding that good judgment, and respect for your own subordinates as people, will make you an effective leader in the Marine Corps JROTC program. ❖

Ethics, Morals, Values

PURPOSE

This lesson explains ethics, morals, and values as they relate to the Marine Corps.

Introduction

What leads you to make a decision in a given situation? What tells you when to act and when not to act?

You determine whether you are acting in a correct way based on your personal **code of ethics**. This is not usually a conscious effort. However, you may find yourself in a situation that does not have an easy solution. It is then that you must think carefully and decide what is the appropriate thing to do. In other words, you must rely on your **ethics** and **morals**.

Definition of Ethics and Morals

Many of the great minds of history have directed their thoughts toward the complex subject of ethics. Many books have been written and many opinions have been expressed. For our purposes, the definition of ethics will concern how you go about determining whether or not you are acting in a correct manner. Refer to the following definitions:

- Ethics are a set of standards or a value system by which human actions are determined to be right or wrong, good or evil.
- A code of ethics contains rules of conduct generally recognized in respect to a particular class of actions.

Morals are defined as conforming to an established set of codes or accepted notions of right and wrong.

Marine Ethics and Morals

In the Marine Corps, ethics and morals are constantly tested. Throughout their history, Marines have been called upon to make life or death decisions. They have been given the trust of the American people. For this reason, they are expected to be disciplined and show courage in defense of their ethics and morals.

While there is no written list of rules for ethical behavior, some standards have been established. Two primary examples of Marine Corps standards include the following:

- A Marine's word is his bond.
- Marines take care of their own.

The above is an example of written standards. A code of ethics is not documented. It is not carved in stone, nor is it handed down from superiors. A code of ethics evolves naturally through an individual's upbringing, education, maturity, and social influences. The Marine Corps, then, gives the guidelines and guidance that should allow for further development of this code.

Take note that these standards not only apply to Marines but also to MCJROTC cadets. As a MCJROTC cadet, you are a reflection of the Corps itself. Therefore, you must develop ethical standards in line with the standards of the Corps.

Professional Ethics

Marines have a basic set of professional ethics to guide their actions. Not only must they

act in accordance with these guidelines, but they must also inspire and encourage others to follow this code.

The professional beliefs and values that are encouraged in the Marine Corps consist of the following:

- Loyalty to the Ideals of the Nation
- Loyalty to the Unit
- Personal Responsibility
- Selfless Service
- Self-Discipline



Background

You may be asking where did this code come from and who decided that things should be as they are?

The code of ethics of the United States Marine Corps is directly traced to the Declaration

of Independence and the Constitution. These documents are the basis of American life for they guarantee freedom and justice. They state the rights of all human beings. The authority of freedom and justice is indisputable. It is upon these values that the founding fathers constructed this nation.

It is also upon these values that the great leaders of American military history based their code of ethics. In order to maintain the honor of the nation, Marines must act in a moral and upright manner. This kind of behavior will only be possible if they have a code by which to judge their actions. They must also remember that their professional code must come before their personal values. They must be absolutely committed to the institutional values that form the basis of the professional ethic.

Loyalty to the Ideals of the Nation

The first of these values is **loyalty** to the ideals of the nation. The only reason that the Marine Corps exists is for the defense of the nation. It is the function of the military to enforce the policies of the nation, not to dictate them. This requires that every military leader must be prepared to carry out orders, so long as they are lawful and moral.

Loyalty to the nation means a number of things. It means believing in truth, justice, freedom, and equality. For Marines, it means they are willing to defend these ideals, ideals for which many wars were fought and many Marines died. Actions that support these ideals are right and actions that do not support these ideals are wrong. Therefore, Marines must always support the ideals found in the Declaration of Independence and the Constitution, regardless of where they are or what the circumstances are. It demands both loyalty and commitment, and it asks that they desire only to serve their country. Marines are defenders of their

country, which is an honorable profession. There is no greater calling, nor higher virtue.

As a MCJROTC cadet, it is important for you to be familiar with these aspects of professional ethics and to understand the concept behind each.

Loyalty to the Unit

Loyalty to the unit is of great importance to any leader. Next to the accomplishment of the mission, the most important thing for a leader is the unit. Leaders have certain obligations to the unit. These obligations include the following:

- Conservation of Lives
- Well-Being of their Team
- Development of a Cohesive Group

Conservation of Lives

Although the accomplishment of the mission comes first, a leader must also be concerned with the conservation of lives. Everyone admires courage, while no one admires foolishness. To be reckless in the accomplishment of the mission is wrong, for it is unethical to unnecessarily put anyone's life in danger.

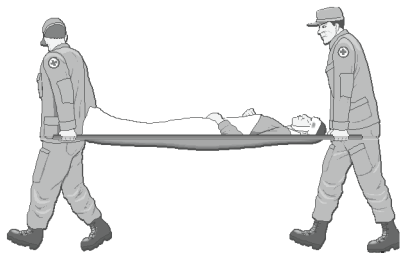

Well-Being and Pride of their Team

Leaders must also see to the well-being of their team. This means that they must ensure that their unit has the best possible care. Marines should be devoted to their unit and proud of their

unit. Much of what they do as leaders will affect whether their team members share in their pride and devotion. If a leader is not devoted to the unit, the members of the unit will not be devoted to the unit either. This results in a lack of cohesion.

Development of a Cohesive Group

Cohesion is very important and must be one of the main concerns of a leadership decisions. A leader must develop a unit from a group of individuals. To accomplish this, it is necessary to form and mold the individuals into a unit that can accomplish its mission. The unit must see itself as a team, and must place the goals of the unit ahead of their own personal needs and desires.

If Marines are loyal to their unit, it will help the unit gain in strength and character. Loyalty to the unit is a significant part of the Marine code of ethics. Likewise, cadets in the MCJROTC must be loyal to their units, thus developing a unit with high ethical standards.

Personal Responsibility

To be personally responsible means that Marines are obligated to accomplish their mission to the best of their ability. It also means that they should attend to their commitments, and seek to improve themselves in all ways at all times. Personal responsibility means that leaders are responsible for their actions and for the actions of those in their command. Personal responsibility for MCJROTC cadets applies to their obligation to accomplish their assigned tasks and performances to the best of their ability.

Selfless Service

Selfless service means that a leader's actions and the unit's actions should always reflect what is best for the Corps and the nation. For

Marines as individuals, selfless service means that the needs and goals of the nation, the Corps, the unit, and other Marines come before their own. Service is a Marine's job and this means that each Marine should strive to work harder than anyone else in the unit.

Keep in mind that the mission always comes first, then the unit, and then the leader. In order to accomplish these priorities, a leader must have self-discipline. The ideal of selfless service in the MCJROTC is upheld, although on a smaller scale.

Self-Discipline

As an individual and a MCJROTC cadet, self-discipline means that you do what needs to be done regardless of stress, exhaustion, or other conditions in the situation. Self-discipline will help you develop your natural talents and abilities. You will be able to withstand more and you will be able to do more in various situations. In order to develop the kind of self-discipline that will be needed, you must have pride in your unit and yourself.

This pride cannot be taught, but it can be developed. It must come from within the individual, who must be proud to be a cadet, and proud to be a member of the MCJROTC. Cadets must be concerned with their personal standards of conduct. A MCJROTC cadet possesses the right attitude, a sincere sense of obligation, and high standards.

Core Values

In order to develop this sense of pride in the unit and the MCJROTC, cadets must be in tune with their values. Values are your attitudes about the worth or importance of people, concepts, or things. It is upon these values that

the fate of the program rests, so these values must be of a high enough caliber to allow each member of a unit to become a good cadet. Traditionally the core values are:

- Honor
- Courage
- Commitment

Honor

Honor is the quality that guides Marines to exemplify ethical and moral behaviors, such as:

- Never lie, cheat, or steal
- Maintain integrity
- Respect human dignity

Courage

Courage means doing the right thing, regardless of the consequences, and taking responsibility for all actions. Moral courage, not physical courage, is what it takes to do the right thing in the face of adversity and disapproval.

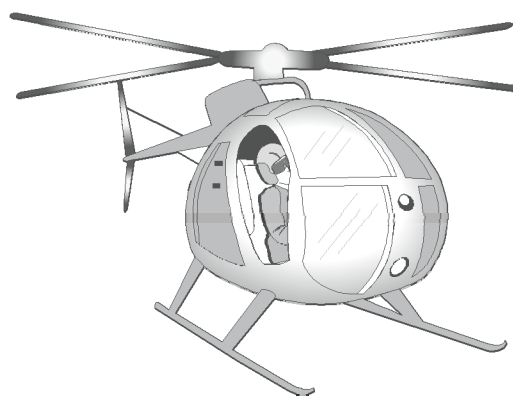

For you, there may be a time when having to make a decision will be a very stressful situation. You might be under pressure from a

superior, a peer, or a team member to act in a manner not in accordance with your code of ethics. In times such as these, you will need to exhibit great courage to adhere to your ethics. An example of these situations might include cheating on exams, using drugs, or any number of other unethical activities. You must act in a correct manner, regardless of the source or the kind of pressure. (Courage is discussed in more detail in a subsequent lesson.)

Commitment

Commitment is the spirit of determination and dedication within individuals. Commitment is defined as an agreement or pledge to do something.

When contemplating possible solutions to a problem or dilemma, you should remember that you are committed to your school and to the MCJROTC program. You must remember that you have the responsibility to act in a manner that exhibits your dedication and devotion.

Values and Standards

In the Marine Corps, Marines must be committed to adhering to the values and standards that will lead them to act correctly. These values and standards are listed as follows.

- Legal Standards are formal regulatory standards contained in law.
- Basic National values established in the Constitution, Declaration of Independence, and other documents and traditions that provide the foundation for required behavior for all Marines.
- Traditional Marine Corps values are required behavior for all Marines such as Loyalty to the Ideals of the Nation, Loyalty to the Unit, Personal Responsibility, and Selfless Service.

- Actual Marine Corps values are the values that are functioning in the local units. They are the standards governing day-to-day behavior in the Corps. Actual Marine Corps values are often the same as traditional Marine Corps values.
- Individual values are values held by the individual Marine involved in the situation.
- Institutional pressures are elements of Marine Corps policies, procedures, operations, and other aspects that influence the ethical behavior of Marines.

As a MCJROTC cadet, if you keep all of these values and standards in mind when making decisions, you will be able to act correctly. You will be able to stay within your code of ethics. It should be remembered that ethics are an extension of the individual.

Conclusion

As you can see, the subject of ethics is very involved and complicated. Ethics involves your attitudes about your unit and yourself. You have learned that your ethics should be based on values that are traditional and beyond question. If you remember what you have learned today, you will be better equipped to make tough decisions in the future. ❖

Marine Corps' Core Values

PURPOSE

This lesson explains and provides examples of honor, courage, and commitment as they relate to the Marine Corps.

Introduction

The 31st Commandant, General Charles C. Krulak, said in July 1996:

“Our challenge is to be a Corps of men and women who consistently represent the highest moral character in and out of uniform. Character creates a foundation of which successful military units are built. From this foundation, Honor, Courage, and Commitment will always be evident, providing the perfect description of a United States Marine.”

Core Values

By understanding the core values, Honor, Courage, and Commitment, you will understand how these ideals will make better MCJROTC cadets and ultimately better people.

Honor

Honor is the quality that guides Marines to exemplify ethical and moral behavior. These behaviors include:

- Never lie, cheat, or steal
- Abide by an uncompromising code of integrity

- Respect human dignity
- Respect and concern for each other
- Quality of maturity, dedication, trust, and dependability that commits Marines to act responsibly
- Accountability for your actions
- Fulfillment of obligations, and hold others accountable for their actions

By following this code of conduct, you will be able to make better decisions to difficult problems.

Courage

Courage is a mental quality that recognizes fear of danger or criticism, but enables a leader to proceed in the face of it with calmness and firmness. It is a quality of mind that gives leaders control over fear, enabling them to accept responsibility and to act properly in a threatening situation.

There are two kinds of courage: physical courage and moral courage. Physical courage is the ability to overcome the fear of bodily harm. All people feel fear, but not all overcome it. Should you become a MCJROTC leader, this hurdle must be cleared. Your unit will not follow you if you do not lead and you will not be able to lead if you cannot overcome your natural physical fears.

Moral courage is the courage to stand firm in your values, morals, and convictions. You must do what you feel is right, for if you go against your own morals, values, and convictions, you have betrayed yourself, your unit, and the MCJROTC. Moral courage means knowing and standing up for what is right in the face of popular

disagreement. Leaders who have moral courage will admit their errors and accept blame when they are at fault, but will enforce their decisions when they are sure they are correct. To help attain and demonstrate courage, leaders should study and understand their reactions to fear and control their fear by developing self-discipline and courage.

Commitment

Commitment means the dedication to carry out all unit tasks and to serve the values of the country, the MCJROTC, and the unit. Commitment leads to the highest discipline for your unit and yourself.

For Marines, commitment is the ingredient that enables 24-hour-a-day dedication to Corps and country. As a cadet, you can exhibit commitment in the following ways:

- Being proud of your unit
- Having concern for others
- Keeping the determination to achieve excellence in any endeavor

In addition to these ideals, your values must also be applied to other areas. These might be ideas such as punctuality, truthfulness, and fidelity. You must also value the outer signs of these ideals, such as having good personal hygiene and a spotless uniform. Last, but by no means least important, you must apply your values to friends, family, and fellow cadets.

Pressures of Leadership

Since leaders are decision makers, they must make choices based on values and beliefs. Sometimes leaders are put in situations where two or more values conflict, otherwise known as a **dilemma**. You may have to choose between two or more undesirable alternatives. Perhaps you are

faced with a “simple” dilemma such as when you choose between going hungry or eating something you really dislike.

An ethical dilemma, on the other hand, is more complicated because an individual must decide between two or more values that are at odds. When you find yourself in an ethical dilemma, you must search for the morally right thing to do. The right thing to do is the moral action that best serves the ideals of your organization or group. The “highest moral good” is what professional ethics are all about.

If you make the right decisions when faced with an ethical problem, you will continually build your character and leadership. However, if you fall into the trap of taking the easy way once or twice, you will tend to justify your actions and then begin to erode your character. Your fellow cadets will sense this over a period of time and gradually lose respect for you. You will then be forced to use coercion to motivate them and will eventually lose the necessary foundation for positive, inspired leadership.

Anyone can be ethical when there are no pressures to be unethical. At times, however, there are certain things such as personal ambition, convenience, greed, and prejudices that get in the way of ethical behavior. After all, leaders have human desires and motivations.

Sometimes there is pressure to bend or break the rules a little in order to get a promotion, gain popularity, or make it easier on a subordinate. That old saying, “The end justifies the means,” could provide every leader with an easy excuse for doing something questionable. Leaders must be aware of these temptations and guard against them by maintaining a professional code of ethics. A **principle**, a belief, or a value is but a concept until it is tested under pressure.

Maintaining Your Ethics

You usually know in your heart the right thing to do. The real question is whether you have the character to live by sound professional values when under pressure. If you have the right beliefs and values, the thing to do in most situations will be clear and you will do it. Just think through the problem, sort out the facts, and weigh the alternatives.

Developing an Ethical Climate

To develop and maintain the correct ethical climate, leaders should reach out to their organizations, know the details of their job, trust their people, and take risks on their behalf. Recognizing that actions speak more powerfully than words, leaders encourage openness and even criticism, they listen and support followers who show initiative, and they forgive honest mistakes made in the process of learning.



Historical Case Study # 1

The story of Lieutenant Presley Neville O'Bannon begins in 1805. For several years American ships plying the waters along the coast of North Africa had been endangered by bands of Barbary pirates who grabbed what loot they wanted, killed many of the seamen, or shackled them to lives of slavery. Annual payments in tribute to the area's many rulers were demanded for "protection" of American lives and shipping.

Although the United States was tired of a Naval war, which had dragged on for several years, it decided to carry the fight to Derne, the inland stronghold of the enemy and chief fortress at Tripoli. To do this, General William Eaton, U.S. Navy agent in charge of the region, asked for 100 Marines from a nearby U.S. squadron. In answer to his request, a young Virginian, Lieutenant Presley Neville O'Bannon, and seven enlisted Marines were placed at Eaton's disposal.

O'Bannon was given an odd assortment of men to form a task force formidable enough to seek the surrender of Jussup - the reigning Bey of Tripoli. Together with his handful of Marines, a few Greek mercenaries, and a motley crew of cutthroats and sheiks loyal to Hamet Karamanli, the disgruntled brother of the Tripolitan ruler, he started from Egypt on the 600-mile trek across the desert of Barca.

Along the way, every obstacle known to the East beset Eaton and O'Bannon. Instead of the usual two weeks, the trip took 45 days. While on his journey, O'Bannon was called upon to prevent the Moslems plundering the Christians. It was he who brought the numerous revolts of the camel drivers to a halt. He constantly prodded the Arab chiefs who repeatedly refused to proceed. All these delays prolonged the journey, stretched food rations, and at times, exhausted water supplies.

On April 25th, the forces under Eaton and O'Bannon reached Derne and terms of surrender were offered to the enemy. The flag of truce was immediately returned. "My head or yours," came the reply from the Government's stronghold.

O'Bannon then swung into action. With the support of naval gunfire from American ships in the harbor and accompanied by his seven Marines, he spearheaded a bayonet charge, which resulted in the capture of the fort on April 27, 1805. O'Bannon personally lowered the Tripolitian flag and hoisted the Stars and Stripes for the first time on foreign soil, securing the War with Tripoli.

Hamet Karamanli promptly took over as ruler of Tripoli and presented the Marine lieutenant with his personal jeweled sword, the same type used by his Mameluke tribesmen. Today, Marine officers still carry this type of sword, commemorating the Corps's service during the Tripolitian War, 1801 - 1805.

Appropriately, the actions of O'Bannon and his small group of Marines are commemorated in the second line of the Marines' Hymn with the words, "To the Shores of Tripoli." These same words were also inscribed across the top of the Marine Corps' first standard, which was adopted around 1800.

Upon his return to this country O'Bannon was given a welcome by the people of Philadelphia and was acclaimed, "The Hero of Derne." After leaving the service, O'Bannon went to Kentucky, where his brother, Major John O'Bannon, a Revolutionary War figure, was living. Shortly after his arrival he was elected by the people of Logan County to represent them in the state legislature. He served from 1812 through 1820.



QUICK, John Henry
Sergeant, U.S. Marine Corps
G.O. Navy Department, No 504
December 13, 1898

Historical Case Study # 2

John Henry Quick was born on June 20, 1870, in Charleston, W. Va. He enlisted in the Corps in Philadelphia on August 10, 1892. Participating in every campaign the Marines were involved in during his enlistment, he was the holder of several awards for valor. In particular, an act written about Quick by Stephen Crane, a war correspondent and novelist, won Quick the Medal of Honor.

June 14, 1898, during the Spanish American War, two companies of Marines were tasked to capture Cuzco well, an important water supply in Cuba. As the Marines advanced on the well, they were attacked by the Spanish troops positioned in defense. The Captain in charge of the Marines signaled the USS *Dolphin* to provide naval gunfire in support of the Marines assault. As a result of poor positioning, the signal was

misinterpreted and the Marines became the subject of "friendly fire." John Quick, then a Sergeant, placed himself where he could be seen by the ship's crew, stood up in the midst of the incoming shells and explosions and signaled for a cease-fire. The flag he was using was not very visible, so the intrepid Marine shifted his position to the top of the hill. At this point, the Sergeant came under intense enemy small arms fire. He calmly turned his back to the enemy and continued to signal the ship. Letter by letter, sending Morse code, he completed his message, picked up his rifle, and rejoined the firefight. Crane wrote:

I watched his face, and it was as grave and serene as a man writing in his own library . . . I saw Quick betray only one sign of emotion. As he swung his clumsy flag back and forth, an end of it once caught on a cactus pillar. He looked annoyed.

During the Philippine insurrection Quick participated in the ill-advised but heroic march across the island, Samar. The leadership and courage of Quick is credited with giving other members of that patrol the fortitude to complete that ordeal. "Stand, Marines, He served on Samar" became a standard greeting when any member of that unit entered a room for several years after this action in honor of the character displayed by the men of this patrol.

Twenty-six years of service as a Marine involved Quick in places and situations that are legendary and still spoken of with awe by Marines to this day. Some of them were the West Indian Campaign, the Spanish Campaign, Philippine Campaign, Cuban Campaign, Mexican Campaign and finally, World War I. While it was an important time for the Marines, it was also a period of deep and influential changes in the Marine Corps theory of operations, which remains

valid for the most part into today. One thing that never changed, though, was the solid leadership displayed by this heroic Noncommissioned Officer.

During the Vera Cruz Campaign of 1913 he was again cited for valor during the assault of that Mexican city, for which the Secretary of the Navy commendation said of his performance: "He was continually exposed to fire during the first two days of the operation and showed coolness, bravery, and judgment in the prompt manner in which he performed his duties."

He spent only four years before he was again thrown into the burning cauldron of war. This time he sailed for France as part of the Marine Brigade, as Sgt. Major of a battalion of the sixth Marines. It was at Belleau Wood, where an Old World army was introduced to the fighting abilities of the modern U.S. Marines for the first time. This is where the Marines earned a new name, Teufelhunde-Devil Dogs. It also earned the Sgt. Maj. the Distinguished Service Cross and the Navy Cross.

Sergeant Major Quick retired from the Marine Corps on November 20, 1918, and died in St. Louis, Mo., September 10, 1922. He was fifty-two years old.

Conclusion

Everyone lives according to what they feel is worthwhile or according to their value system. A person's value system motivates their thinking and actions. Values and leadership are closely linked. By exploring this connection and understanding the enormous impact of personal values on individual behavior, you will be better equipped as a MCJROTC leader. By understanding human behavior, leaders are more able to analyze, predict, and influence the behavior of others. ❖



MACKIE, John F.
Corporal, U.S. Marine Corps
G.O. Navy Department, No. 17
July 10, 1862

Historical Case Study # 3

Corporal John F. Mackie was the first U.S. Marine ever to receive the Medal of Honor. He earned the medal on May 15, 1862, while serving on board the U.S.S. *Galena*. Confederate forces repulsed a Federal fleet attempting to reach Richmond in the attack on Fort Darling at Drewry's Bluff, James River.

As enemy shellfire raked the deck of his ship, Corporal Mackie maintained his musket fire against the rifle pits along the shore. When ordered to fill vacancies at guns caused by men wounded and killed in action, he manned the weapon with skill.

The Medal of Honor is the highest decoration for valor given by the U.S. Armed Forces.

Using Introspection to Develop Leadership Traits

PURPOSE

This lesson addresses one of the primary questions concerning leadership: “How do I go about developing the traits, qualities, and principles necessary to become an effective leader?”

Introduction

The development of positive leadership traits and qualities is an internal maturing process that you control. It is up to you to decide what kind of person you are going to be. Character development takes a great deal of soul searching and introspection.

Definition

Introspection is when you examine your actions and motives to see whether you are acting in a correct and responsible manner. Socrates, the Greek philosopher, once said, “The unexamined life is not worth living.” One might paraphrase Socrates by saying that the leaders who have not taken stock of themselves and have not corrected any mistakes are not worth following; nor will they be able to lead effectively.

Introspection, or self-assessment, takes time and effort. It requires that you be dedicated and patient. Developing strong leadership traits takes a great deal of hard work. The road to success in this respect has always been difficult, for there is no such thing as easy growth.



Introspection will help you develop character.

Methods of Introspection

Different people have different ways of achieving “self-assessment” or “introspection.” Most, however, take a few moments out of the day to take stock of their attitudes and actions of the past 24 hours. Some people call this a prayer exercise or meditation. Others refer to it as a moment of introspection or peace and quiet. Regardless of what it is called, it accomplishes the same thing: It gives the individual peace of mind and direction, provided the individual looks honestly at what has been done.

Specific Time

The best way to go about this exercise is to designate a certain time every day for **contemplation** and **reflection**. If you make

introspection a habit, eventually it will become easier. This is not to say that you will be able to take five minutes and solve all your problems. It means that you will become familiar with those attitudes and methods that allow self-examination. You will become more comfortable with the process and it will become easier for you to recognize problems as they arise.

Involve Yourself

The success of introspection depends on your willingness to involve yourself. If you are to become a leader, some endeavor involving self-assessment is necessary. Remember, it is for your own leadership development.

Getting Started

When you begin the exercise of introspection, you must establish the following guidelines so that the exercise is an effective and positive method of developing your leadership traits.

No Perfect Leader

The first thing to remember is that you need not try to make yourself into a perfect leader on the first day. No one is perfect; everyone has faults. If you were to list all of your faults every day, it would have a negative effect. Rather, try to come up with alternatives to how you could better handle a given situation.

Learn from Mistakes

You should not be too hard on yourself for making mistakes in areas where you are trying to improve. Suppose you have been trying to be more understanding and pleasant with members of your family. This is not always the easiest thing to do. You are human and are prone to mistakes; hence, in anger, you might lash out at someone

unjustly. It is important for you to recognize that you have done this, just as it is important for you to not condemn yourself for one mistake. Correct it, stay with it, and above all, work on the problem. Self-improvement takes time and effort. It is not easy for anyone.

Questions for Introspection

When exercising introspection, you should evaluate how ethical your actions have been. You might ask yourself some of the following questions:

- Have I been honest with my teachers, peers, parents, and family?
- Have I been kind in my dealings with subordinates, peers, parents, and family?
- Have I been firm in my decisions?

You will find that this kind of inquiry will give you excellent insight into your own thinking processes and actions. It will give you a clear idea of where you are going and how you are getting there.

While you are involved in this, you should remember to be positive in your assessment, otherwise you will fall into the trap of negative thinking. The object of introspection is to improve yourself, not to concentrate on your faults. You should concentrate on what you can be. Few people ever realize their potential; however, if you work hard at it, you will reach yours.

Positive Attitude

During introspection, it is best to have a positive attitude. This does not mean, however, that you can afford to ignore your faults and weaknesses. It means that you should concentrate

on what you can do to improve yourself. A positive attitude will allow you to make improvements in your character by seeing what you can become. All that is asked of you is that you achieve your potential.

Conclusion

You should ask yourself: “What can I do today that will help me to become a better person? What can I do within my daily routine that will help me to develop the traits of leadership that I will need?” If you can generate one or two good ideas a week that will help you alter your behavior for the better, then you will be making excellent progress.❖

Military Leadership Traits

PURPOSE

This lesson explains and provides examples of the fourteen military leadership traits used in the Marine Corps.

Introduction

Many traits allow you to become a good leader. The list is probably endless. The following fourteen military leadership traits will help you to be a good leader in the MCJROTC.

Your personal development of these traits will take time and effort. First, evaluate yourself and see what traits you have or want to develop. Then, determine what you need to do to improve the traits you have or will develop. Ask yourself, am I living up to the standards of a leader? Ask yourself, “Would I be willing to follow the same kind of person that I am?”

1. Bearing

You should always attempt to create a favorable impression by your appearance. You should carry yourself well, and always act in a manner becoming to an officer.

This means that you should always look, act, and speak like a leader -- whether you feel like it or not. There will be times when you will wish that someone else could take the responsibility for a while. To feel this is one thing; to let it show in your actions and appearance is quite another. If people see that you are discouraged, then they, too, will be discouraged. Remember, you lead by

example and to hang your head, to be out of uniform, or to speak in pessimistic tones implies a sense of fear and a lack of desire. Your job is to lead; where you lead, is up to you. If you have a positive attitude, so will your team members. Your appearance and carriage will express your attitude and feelings.

There are many examples of **bearing** in American history. An outstanding example is George Washington, whose great bearing and stature were displayed at Valley Forge and at Trenton. Robert E. Lee showed, in his attitude and appearance at Appomattox, that he was an officer and a gentleman. Nathan Hale exhibited great bearing and courage at the makeshift gallows that took his life. Of course, you may never be asked to exhibit your own bearing and courage to this degree, but you must understand the significance of this trait.

2. Courage

The **courage** that allows one to perform effectively, in spite of hardships, takes many forms. Courage is the mental quality that allows you to face fear and to overcome it. This means both the fear of physical harm and the fear of criticism.

Courage is a quality or trait that all people must have in order to face danger. The courage of men in the Marine Corps like Smedly Butler, Dan Daly, and “Chesty” Puller are examples to us all. These men showed us how to lead during difficult times. They did so with little regard for their own welfare and with nearly complete disregard for the possibility of physical harm. They showed great physical and moral courage. Their moral courage was shown in the fact that they could not have

faced danger in the manner that they did, unless they believed in what they were doing. They had the courage to stand up for their beliefs and to do their duty as required by the situation.

You must also have the courage to stand up for your beliefs. You might not ever be asked to exhibit the physical courage of the men mentioned above; however, you will be asked to exhibit courage in defending your ethics and values. To do the right thing in the face of adversity and opposition is not easy. One of your friends may ask you to do something unethical. It will be up to you to do what is right.



A good example of this kind of courage can be found in the presidencies of Abraham Lincoln and Gerald Ford. Abraham Lincoln had to take drastic actions to keep the Union intact. He stretched his powers to the limit. He even went beyond the legal limits set by the Constitution. This took great courage and heart, but Lincoln knew that the Union had to be preserved, so he did what he had to do. Consequently, he paid for it with his life.

Gerald Ford was asked to show the same kind of courage, although to a lesser degree. Ford came into office in one of the worst situations in the history of the presidency. Former President Nixon had left the presidential office in disgrace and the faith of the public in our system of justice and government was shaken. The populace was divided concerning how to deal with the actions of the former president. President Ford was faced with the difficult decision of whether to prosecute or pardon former President Nixon. He knew the consequences. He knew that the pardon was a move that could cost him his political career. He also knew that the country would be divided if the former president were prosecuted. Finally, he mustered the courage to do what was necessary and issued the pardon.

3. Decisiveness

Decisiveness is a quality that allows an individual to take swift and firm action. To be able to make such decisions, and take such actions, you must also be informed of all available facts. A person must also be courageous to be decisive. The decisions you make will not always be popular.

Those same decisions of Lincoln and Ford also provide excellent examples of decisiveness. President Lincoln realized that some of his decisions would be unpopular but that in order to save the Union he would have to act quickly and decisively. If he had waited to take a stand, the South might have had time to establish control over the seas. It would have set up defenses, solidified its own system of government, and united its military. For this reason, Lincoln acted quickly. If he had not, the war might have lasted longer than four years.

President Ford understood the unfortunate situation concerning Richard Nixon

when he came into office. He realized that if something was not done right away, the situation would worsen. As we saw earlier, the country was split on the question of how the former president should be treated. Ford acted quickly and decisively and granted former President Nixon a full pardon.

When you are making a decision, you must always remember that you should get all the available information within the constraints of time. When this is done, you must act as quickly as the situation requires. You must be firm in your actions and confident in your decisions.



4. Dependability

Being dependable means other people will know that you will perform your duties in a proper manner. In the eyes of your superiors, this is a quality or trait that is of the utmost importance.

If your superiors give you a mission to accomplish, they **want** to be sure that it will be completed. Your team members will be depending on you to lead them in a manner that will allow them the most safety under the given conditions. You will have to be able to follow orders. You will have to instill in your unit the same attitude.

President Harry S. Truman demanded **dependability** from his subordinates. He was not a man who was willing to put up with anything less. He needed to be sure that when he gave an order, it would be followed to the letter. It was for this reason that Gen. Douglas MacArthur was relieved of command in 1951. MacArthur went beyond his orders by trying to dictate foreign policy to the President. He could no longer be depended upon to carry out the mission his country had set for his forces.

You must accomplish your tasks according to your orders. Civil and military laws require that you follow your orders and that you accept that no one is above the law. Douglas MacArthur was a five-star general, but he could not be depended upon politically and for this reason he was relieved of his command in Korea (1951). This is the worst of all possible fates for an officer, who is expected to serve the country according to the nation's standards, not the officer's own.

You will find that if you follow your orders and accomplish your tasks, you will always have the trust and respect of your superiors, your peers, and your followers. Trust and respect for a leader are of great importance. Would you want to follow a person whom you did not trust and respect?

5. Endurance

Endurance is the ability to endure hardships. These hardships might include hunger, cold, heat, and excessive stress.

Physical and mental endurance and toughness are necessary for all cadets. This trait, like those that have been discussed above, will serve you well in many situations. Endurance helps one to deal with hardships. No one enjoys uncomfortable or stressful situations, but they can be endured if you develop a sense of pride in your work.

When you have to work long hours with little rest, you will need to be able to endure both physically and mentally. You will need to maintain a positive attitude and be physically fit to accomplish your task.

This trait of endurance is not new to the Marine Corps, since Marines have been enduring hardships throughout their history. They have been away from their families, they have been in constant danger, and they have had to fight for their lives. Sometimes, the Corps itself has had to fight for its very existence as the politicians tried to dismantle it. To endure and to overcome is the essence of the Corps. To endure in order to accomplish one's mission is the duty of every Marine.

Marines have endured from the “Halls of Montezuma to the Shores of Tripoli,” from Iwo Jima to the Chosin Reservoir. Marines have always managed to accomplish their mission. Although you as a cadet may not face the rigors of a Marine, endurance can nevertheless be of great value. It can help you in both the MCJROTC competitions and in school activities.

6. Enthusiasm

In order to be enthusiastic, you must show interest and exuberance in the performance of your duties. It is necessary that you remain optimistic and, if possible, cheerful. Remember, a positive attitude is a necessity if you are to make

any progress in this attempt to acquire the traits that will allow you to become an effective leader. You must always keep your bearing. Keep your head up, and maintain your appearance so that your team members can see that you have kept up your level of **enthusiasm**.

The reason for the maintenance of this attitude is the fact that you must set an example for your team members. If they see that their leader is despondent and distraught, then they will be also. Even in the face of overwhelming odds, you must remain optimistic. Many examples of this are found in the history of military conflicts.

When surrounded by the advancing German army at Bastogne during the Battle of the Bulge in World War II, Brig. Gen. Anthony McAuliffe was asked by the enemy for his surrender. He replied, “Nuts.” His answer inspired his men to fight and turn the tide in one of the last great battles of the war.



At Chosin Reservoir in Korea, the First Division was surrounded by eight Chinese divisions at the same time. Yet, Col. Lewis B. “Chesty” Puller said: “We’ve got them right where we want them. They won't get away this time.” Puller’s First Division defeated all eight divisions during their breakout and march to the sea.

You may or may not be involved in such a situation, but you must keep your enthusiasm on a daily basis, regardless. If you have an after-school job, are on an athletic team, or are a member of a school club, you must remain enthusiastic. Your enthusiasm is important in your studies and in your devotion to your MCJROTC unit and your school.

7. Initiative

Initiative is the ability, or presence of mind, to take action in the absence of any clearly defined orders. It means doing something on your own, not just when you are ordered. You must go the extra mile.

It will often be necessary for you to work with little or no supervision. During these times, you will have to make decisions concerning how the work is to be done. If your commanding officer tells you to accomplish a task, but does not tell you how to do it, you must take the initiative and develop your own plan of action.

There may be other situations that also call for initiative. For example, a Marine in a combat situation, isolated from his own line or having lost his commanding officer, may have to lead. He has to take the initiative. This is something that has happened in virtually every conflict in which the U.S. Marine Corps has been involved.

As a cadet, your leader may not always be present, thus forcing you to take initiative. Initiative means having the ability to see what has to be done and doing it. You should not have to be told everything, so if something needs to be done, do it. Enthusiasm has a great deal to do with initiative. The exuberance that you show in doing your job will often lead to going beyond your orders and going the extra distance.

Initiative also sets a fine example for your team members. It shows that you have the enthusiasm, the decisiveness, and the dependability to get the job done. Remember, part of your job is to train others to lead and to take on greater responsibilities. With the exception of the accomplishment of the mission, this is your greatest responsibility and you should take it very seriously.

8. Integrity

Integrity means that in order to lead, you must be honest and upright; you must be truthful in your actions and words. If you are anything less, your team members, your peers, or your superiors will not be able to trust you.

Trust is essential in any leadership situation, for if your team members cannot trust you, they will not follow you. You must also have the trust of your peers. If you cannot be trusted, you should not be leading.

In order to maintain your integrity, you must adhere to your code of ethics. Your code of ethics guides you to do the correct and moral thing, consistent with the highest values of your society as a whole. This is not always easy. There will be times when you will be tempted to act in a manner that will threaten your integrity. In times such as these, you must ask yourself whether or not you are doing the right thing. If you behave in an unethical manner, your team members will come to distrust you.

You might be asked to lie, cheat, or engage in illegal activities. Some of the things that might seem to be meaningless may well turn out to be very important. You never know how many people are depending on you. If you always do the right thing, then you will have nothing to worry about.

9. Judgment

Judgment is the ability to consider all of the factors of a problem or situation. It is then up to the leader to make a correct decision. Good judgment is important for a leader. Your judgment is what will keep your unit running smoothly.

If you show good judgment, it will give your team members faith in your abilities. This in turn will earn their respect and their loyalty.

Quality judgment is not something that comes easily, or naturally, to most people. It is something that must be nurtured and developed. You must take all aspects of a situation into consideration before making a judgment or decision. Without proper knowledge, a judgment cannot be made.

Good judgment is interrelated with most other leadership traits and cannot stand alone. You must use your knowledge, your decisiveness, and your courage in your judgments. You must examine a situation before you can make a decision concerning it.

Your judgment will tell you when to act, how to act, and where to act. It will have to be developed through experience. Learn from what you see and hear and you will develop good judgment.

10. Justice

Judgment will assist you in seeing that **justice** is done. Nearly all decisions that you make can be made solely based on merit, but first you must examine the evidence, or information, to see what does, and does not, pertain to the situation at hand. You must be fair and even in your decisions, and impartiality should be your watchword. Favoritism should never be a factor in the equation.

Justice, like most other leadership traits, will help you to earn the respect of your team members, peers, and superiors. If your team members see that they are treated fairly, they will trust your judgment. Justice will also help you to enforce discipline, because when people see that the rules have been clearly defined and consistently enforced, they will be inclined to follow them.

11. Knowledge

Knowledge consists of both technical and tactical knowledge as well as the knowledge of human nature. It will be necessary for you to keep up with the latest developments in military science and with what is going on in the world as a whole. In order to lead, you must know where you are going and how you are going to get there.

Technical and tactical knowledge will help you accomplish your task, regardless of what that task may be. To develop this knowledge, you will need to become familiar with equipment and the capabilities of the individuals assigned to your unit. You must also be in tune with the individual's emotional states and attitudes. This will help you to recognize and eliminate problems before they get out of hand.

In some historical cases, knowledge of the habits and capabilities of the enemy was essential. This allowed for a fairly accurate prediction of activities and movements. An example of this is from the Revolutionary War. Washington knew that the Hessian troops at Trenton would be celebrating their holiday and would not suspect an attack from the Continental Army. He took them completely by surprise. This gave his men a victory and renewed confidence. It also strengthened the spirit of the American people in their fight for freedom and liberty.

Leaders should develop a program that keeps them abreast of current developments in their specialty (or field), organizational policies, and local and world communities. Technical publications, directives, books from recommended reading lists, magazines, newspapers, and periodicals are valuable aids toward achieving this goal. Serious group discussions, research, professional development/leadership seminars, and experience also contribute to broadening a leader's knowledge.

12. Loyalty

Loyalty is the quality of faithfulness to the country, one's organization (such as the U.S. Marine Corps), seniors, subordinates, and peers. The confidence and respect that leaders can gain from superiors and team members is immeasurable. Conversely, the damage resulting from a lack of loyalty is also immeasurable. For example, although a leader's reputation can spread everywhere if it is based on actions to protect subordinates from injustice, a breach in confidentiality will cause subordinates to lose respect in that leader.

A good leader does not allow personal opinion to interfere with the mission, nor give the impression of disagreement with orders when relaying them to subordinates. View orders as a superior's method of dealing with a situation and support him or her wholeheartedly.

The necessity for loyalty in the unit is beyond question. You must be dedicated to the ideals of the unit. In order to be successful in this, you must also be loyal to subordinates, peers, and superiors. Loyalty is the essence of serving your unit.

Loyalty takes form in many actions that may be required of you. Sometimes you will be asked to follow orders that seem to make little sense, but you must follow them anyway. There are many examples of this kind of loyalty and dedication in the history of the Corps. Marines captured in various conflicts have remained loyal and have thought only of their country and of escape. This is the kind of selfless dedication and loyalty that is required of a leader.

13. Tact

Tact is the ability to deal with others without creating offense. To treat others with courtesy is a sign of maturity and it requires you to be tactful in your dealings with your peers, subordinates, and superiors.

Being tactful and diplomatic in your communications should come as naturally as possible. You should speak to others without being demeaning or condescending. Treat others as you think all people should be treated.

This means that if you have a problem with a subordinate, you should wait for a private moment to discipline the subordinate. Likewise, if your commanding officer makes a mistake in front of others, wait until later to discuss it. Your consideration will be appreciated. No one enjoys being embarrassed. Consequently, if you treat others with courtesy, you will be treated with courtesy in return. Although this practice is not difficult, the use of tact becomes challenging during conditions of stress or when giving criticism to a subordinate.

Usually, a calm, courteous, and firm approach will bring a cooperative response without creating ill feelings. Even though inexperienced leaders sometimes feel that politeness implies softness, there is no reason to

be discourteous when using abrupt and/or forceful orders in emergencies.

14. Unselfishness

As an officer and a leader, you must put the comfort and advancement of others ahead of your own; particularly, you must never achieve at the expense of others.

This does not mean that you should put the needs of your subordinates ahead of the accomplishment of the task, for the task always comes first. However, you must see that the needs of subordinates are taken care of before your own. Such a natural tendency toward **unselfishness** shows subordinates that you are considerate and compassionate.

Unselfish leaders avoid providing for their own comfort and personal advancement at the expense of others. Leaders should place the comfort, pleasure, and recreation of subordinates before their own. It is difficult to respect leaders who seek their own comfort over that of their subordinates or who hoard credit for achievement made possible by subordinates. True leaders place themselves last in priority and share the dangers and hardships with their subordinates.

Importance of Leadership Traits

These fourteen leadership traits are important characteristics for a leader. If subordinates think that you are not concerned with their welfare, they will follow you unwillingly. If you treat them with care and compassion, they will be more likely to follow you anywhere, anytime, for any reason. Never take credit for something a subordinate has accomplished. Also,

remember, you cannot merely act concerned; you must be concerned.

The fact that these traits interrelate cannot be ignored. One must also use discretion in adherence to these traits and qualities, for they sometimes may conflict. It may prove difficult to serve both integrity and tact at the same time. For example, in being honest and in accomplishing the task someone has his or her feelings hurt.

In order to lead others, you must be able to lead and control yourself. A wise man once said, “If one man was to conquer a thousand men in a thousand battles and another was to conquer himself, the latter of the two would be the greater.” In other words, you must first conquer yourself. Only when this is done, may you then teach others.

Everything in leadership starts with the leader. If leaders cannot judge their own character, how can they judge others? If leaders do not know themselves, how can they know others? If leaders are fearful, how can they expect those who follow them to be courageous? If leaders cannot endure, how can they expect those they lead to endure? If leaders are not dependable, how can they expect others to depend on them?

Men and women alike have adhered to these leadership traits, often at great personal sacrifice. John Goreham, a Massachusetts man, formed the first American Rangers in 1743 to help the British defeat the French in L'Acadie, or what is now Nova Scotia. He spent much of his own money and founded a great tradition with those first “ranging companies.” Men like Merritt A. Edson and Evans F. Carlson, founders of the Marine Raiders, carried this tradition into the Marine Corps in 1942. These men practiced the traits of leadership and never abandoned them. They each displayed those qualities, or traits, of leadership described in 1930 by General Lejeune:

The young American responds quickly and readily to the exhibition of qualities of leadership on the part of his officers. Some of these qualities are industry, energy, initiative, determination, enthusiasm, firmness, kindness, justness, self-control, unselfishness, honor, and courage.

John A. Lejeune: Reminiscences of a Marine, 1930

traits and try to apply them in all that you do. If you do these things, you should be able to begin to develop the traits of a leader.

You have just reviewed the fourteen military leadership traits. If you are going to be a strong leader, you must develop within yourself the traits of a good leader. The process is one that takes place from within. ❖

Conclusion

It is up to you to see that you become the kind of person that others will follow. You might try using some of the following ideas to help you to develop the traits that you will need.

For a few minutes each day, sit and contemplate what you can do to make yourself a better person. Consider in what areas you have a chance to make improvements. What are some of the routine situations that will allow you to make some progress toward being a better, more capable, or more effective cadet or cadet officer?

Voice your ideas aloud. Often if you can verbalize an idea, it makes it easier to comprehend and easier to realize. This will help you organize your thoughts and develop them to a greater degree.

Think about your ideas for improvement during the day. You can do this whether you are at school, at work, at home, or anywhere else. In addition to thinking about what you can be, think about what you already are. Concentrate on the positive side of your personality. Negative thoughts are of little or no help.

Learn to relax yourself mentally. In a situation where you are trying to accomplish a difficult task, you need to be relaxed, not tense. Likewise, work on learning the fourteen leadership

The 11 Leadership Principles

PURPOSE

This lesson explains and provides examples of the 11 leadership principles.

Introduction

For any group to be successful, an effective leader must guide it. As a **potential** MCJROTC leader, there are certain proven guidelines, or leadership principles, that will help you to be an effective leader. The implementation of the 11 leadership principles will give you the ability to earn the respect of your fellow cadets, both seniors and subordinates.

1. Self-Knowledge and Improvement

The first and most important leadership principle is to “know yourself and to seek self-improvement.” Successful leaders must be able to honestly evaluate themselves, realizing both personnel strengths and weaknesses. Individuals who rely on their strengths while ignoring their weaknesses cannot be successful leaders. They should continually work to improve their weaknesses, thus developing more strengths.

Not only can you discover your strengths and weaknesses through self-evaluation, but also through evaluation by others. The objective opinions of your friends and superiors can help you further realize your true abilities.

After realizing your strengths and weaknesses, you should seek self-improvement. Self-improvement can be achieved through both study and observation. Study the causes for the success or failure of other leaders: Why did they succeed or fail? How can you avoid similar mistakes? How can you achieve similar successes? If you are able to identify a case where you have failed as a leader, make every effort to analyze that failure objectively and try to determine what you might have done to produce success. Never blame your failure on others or on the circumstances. It is a weakness if you fail to face your own shortcomings. Also, study and practice effective writing and speaking skills. By mastering such skills, you will be able to better communicate and understand commands.

Close observation of people will help you acquire a better understanding of human nature. With such knowledge, a leader can better determine the best way to deal with any given situation. A leader may deal with one situation in a firm, “hard stand” manner, while another situation may call for a “big brother” approach. The manner in which a leader leads varies from situation to situation.

Finally, it is necessary to set a definite goal or plan of self-improvement. Establish what it is that you want to improve and how to go about it. For example, if you wanted to be able to give a successful speech, you could take a class in speech, read speeches given by prominent people, or attend and observe a speech given by a local official.

2. Be Technically and Tactically Proficient



Before you can lead, you must be able to do the job, or “be **technically and tactically proficient.**” This is the second principle of leadership. Technical and tactical training can be gained through books, classroom instruction, or on-the-job training. Respect is the reward of the leader who is technically and tactically competent.

To develop this leadership principle as a cadet, you should first seek a well-rounded education. Taking a variety of courses, practicing the principles set forth in MCJROTC, and studying and researching can contribute to increased technical and tactical knowledge. As a cadet, take every advantage of learning that your unit provides.

You can also increase your knowledge through association with capable leaders. Observe and study their actions. Through observation, you can further develop your technical and tactical knowledge and better understand how to apply that knowledge.

3. Know Your Subordinates

The third principle, “Know your subordinates,” is extremely important. You should know and understand the behavior of each subordinate in your unit and how they react in different situations. This knowledge can prevent future problems, while the lack of this knowledge could endanger the success of the unit. Knowledge of each unit member’s personality will enable you to decide whether close supervision is needed and when and to whom to delegate authority. A cadet who lacks self-confidence and is nervous under stress should not be placed in a position in which a quick and decisive decision is needed.

As a leader, you should always place your unit’s welfare before your own. Oliver Wendell Holmes, Jr., said that “the reward of a general is not a bigger tent - but command.” This statement is pertinent to all leaders. It simply means that a leader’s reward is not luxuries such as a bigger tent, but command itself. It is important that you as a commander share the hardships of your unit.

You should concern yourself with your unit’s health and physical well-being. Protect the health of your unit by supervising hygiene and sanitation. Provide sufficient recreational time and insist on participation.

You are also responsible for your unit’s mental well-being. Be sure to quickly correct **grievances** and remove discontent. Try to keep in touch with the unit’s thoughts. You can do this by making yourself approachable to your subordinates. Make them feel free to come to you for counseling or advice.

4. Keep Your Subordinates Informed

It is impossible to accomplish a task efficiently without correct information. This brings us to the fourth principle, “Keep your subordinates informed.” To promote efficiency and morale, you must inform your subordinates of all happenings that will affect them and give reasons as to why things are to be done. (Of course, the **conveyance** of information is done when time and security permit.) When you keep your unit members informed, they feel they are a part of the team. Information will help them do their job intelligently and will also inspire initiative, enthusiasm, loyalty, and conviction.

A leader should use the chain of command to pass on information. Always be sure that your **immediate** subordinates are passing the necessary information correctly. This can be checked through frequent inspections. Be alert to rumors within your unit, and replace them with the truth. Rumors, or misinformation, can cause serious problems.

5. Set the Example

“Set the example” is principle number five. The attitude of “do as I say, not as I do” is NOT the manner in which a cadet should lead. As a leader, it is your responsibility to set standards for your unit by your personal example. This principle does not only apply when you are on duty, but also when you are off duty. If your personal standards are high, you can expect your cadets to also have high standards. Remember that leadership is set by example and that your cadets will reflect your image.

There are several techniques that can be used to apply this principle. First of all, set the example in personal appearance. Be physically fit,

well-groomed, and properly dressed. If you are sloppy in appearance, your superiors and subordinates will likely lose respect for you.

Second, set an example in your personal conduct. Conduct yourself in such a manner that your personal habits are not open to criticism. Display an outlook that is calm, confident, and optimistic in nature, because your attitude, directly affects your unit's attitude.

Third, set an example of performance. Show your unit that you are willing to do the same things that you ask of them. Share danger and hardship with your unit to demonstrate your willingness to assume your share of difficulties. All of these steps will help you acquire the respect, trust, and confidence of your unit.

6. Insure the Task Is Understood, Supervised, and Accomplished

The sixth principle, “Insure the task is understood, **supervised**, and accomplished,” is necessary in the exercise of command. You cannot expect your unit to perform if they do not know what is expected of them. This principle is applied in two ways communication and supervision.

A leader must communicate with subordinates in a clear and **concise** manner. Talk on a level that your subordinates will be sure to understand. Do not talk down to them but if you talk at too high a level, they will not understand you. If you talk at a level too low, you will insult their intelligence. Communication should always be two-way, thus giving your unit members a chance to ask questions and seek advice.

Supervision is also essential, for without supervision you cannot be sure that your orders will be properly executed. Under-supervision will

possibly result in the incompleteness or inaccuracy of a task. On the other hand, over-supervision hurts initiative and is viewed as harassment. Therefore, take thought and care in your supervision.



7. Training Your Subordinates as a Team

“Training your subordinates as a team” is the seventh principle of leadership. It is the combination of all the unit members’ efforts that makes a unit successful. Teamwork applies to cadets both in and out of school. Even the most difficult tasks become easier to accomplish when teamwork is evident. Teamwork is a give-and-take situation in which the individuals give their best to the unit; and in turn, the unit provides individuals with security, recognition, and a sense of accomplishment.

As a leader, it is your responsibility to develop teamwork. To do this, you must train, challenge, test, correct, and encourage your entire unit. The hard work strengthens a unit, reduces problems, and is one of the best ways to develop teamwork, morale, and esprit de corps. To further develop teamwork emphasize the “buddy system” and encourage unit participation in recreational and school events.

8. Make Sound and Timely Decisions

The eighth principle of leadership is “Make sound and timely decisions.” Situations frequently call for quick and strong decision making. A leader must be able to rapidly evaluate a situation and make an accurate decision based on that evaluation. Hesitation and indecisiveness might not only cause the unit to fail in the accomplishment of a task, but also could lead to subordinates losing confidence. Loss of confidence, in turn, creates confusion and hesitation in a unit.

If you make a decision and discover that it is the wrong one, do not blame it on others or ignore it. Immediate correction of your mistake will help you to retain the respect of your unit. People do not respect leaders who bluff their way through poor decisions.

There are several steps that can be taken to develop this principle. Plan for situations that are foreseen and announce your decisions in time to allow your subordinates to be prepared. Also, consider the advice and suggestions of your subordinates whenever possible before making a decision. Their ideas are often valuable and can be effectively applied. Finally, consider the effects of your decisions on the members of your unit: How did your decision affect your unit? Was it a good decision? How would you revise your decision under a similar situation?

9. Develop a Sense of Responsibility among Your Subordinates

“Ability is important, but the ability to discover ability in others and then help them develop it is the true test of leadership.” - L. Rader.

This concept brings us to the ninth principle of leadership, “Develop a sense of responsibility among your subordinates.” Mutual respect and confidence can be developed between a leader and a subordinate by assigning tasks and delegating authority. When delegating authority, you should show your faith in your unit members to increase their desire for greater responsibility.

Recognize your subordinates’ accomplishments when they demonstrate responsibility, resourcefulness, and initiative. Let your subordinates know that honest errors will NOT result in punishment. Instead, use their mistakes for critique and constructive guidance. Always be sure to avoid public criticism or condemnation when correcting the errors of your subordinates. Corrections should be done privately, and never in the presence of personnel whom they command or lead.

10. Employ Your Command in Accordance with Its Capabilities

The tenth principle of leadership is “Employ your command in accordance with its capabilities.” Your unit cannot complete a task for which it has not been trained. Failure of such a task causes a loss of morale and self-esteem within the unit. It is wrong to expect five cadets to do a job that would take ten. You also would not send a medical unit to repair a truck. In both cases, the task is not within the unit's capabilities. If you volunteer your unit for impossible tasks, your unit will think that you are seeking personal glory, rather than looking out for their welfare.

A leader should not only avoid assigning tasks that are beyond the unit's capabilities, but should also avoid tasks that do not challenge the unit. Sending ten cadets to do the job of five is a ridiculous waste of manpower and will result in boredom and dissatisfaction within your unit.

11. Seek Responsibility and Take Responsibility for Your Actions

Finally, the eleventh leadership principle is “Seek responsibility and take responsibility for your actions.” You must actively seek out challenging assignments to develop professionally. Seeking responsibility also means that you must take responsibility for all your actions. This means that you are responsible for all that your unit does or fails to do. Never remove or demote a subordinate for a failure that is a result of your own mistake. The great flyer Antoine de Saint-Exupery said, “A chief is a man who assumes responsibility. He says, ‘I was beaten,’ not ‘My men were beaten.’” This is true of an MCJROTC cadet leader. Regardless of the actions of your subordinates, the responsibility for decisions and their application falls on you.

As a leader, you must always issue orders under your own name. Do not issue orders under your commander’s name. In the absence of orders, take initiative to perform the actions your seniors would direct you to perform if they were present. Remember, in such cases, “doctrine” is there to guide you in the absence of instructions. “Doctrine” is the rules and regulations, as well as what you have been taught. It allows you to exercise initiative.

Conclusion

The 11 leadership principles are an intrinsic part of effective leadership. As a potential leader, you must know yourself and continually seek self-improvement. You must be both technically and tactically proficient, so that you can accomplish any task. You must know your subordinates, look out for their welfare, and keep them informed at all times. Insure that every task is understood, supervised, and accomplished by your unit as a team. Be sure to set an example in physical appearance, personal conduct, and performance for your unit.

Always make sound and timely decisions after evaluating a situation and then employ your command in accordance with your unit's capabilities. Develop responsibility among your subordinates and also seek and take responsibility for your own actions.

The implementation of these principles will strengthen you as a leader and increase the respect with which your seniors and subordinates will view you. The eleven leadership principles are the sound basis on which to build successful leadership. ❖

Defining Patriotism

PURPOSE

*What is a symbol? **Symbol** comes to us from the Latin word meaning, “a sign by which one knows something.” A soldier sees a vehicle with a white star on it and knows it to be American. A United States citizen knows the red, white, and blue sewn cloth as the flag of the nation. Many things have come to be special in representing this country. The following is information about some of the symbols that represent the United States.*

Patriotic Symbols

Feelings of **patriotism** are often evoked by the vision of a flag, the sound of a song, or the sight of a statue. Because the emotional impact of a visit to the Vietnam Memorial stirs many different kinds of feelings in each of us, it is difficult to develop a definition of patriotism that fits everyone. However, it is clear that many different symbols have special patriotic meanings for millions of Americans. The following is background on five of the best-known American patriotic symbols.

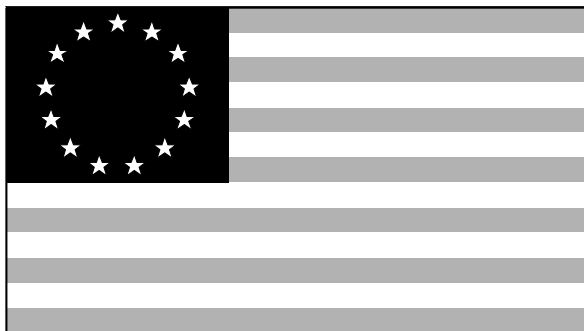

Old Glory

Many Americans believe Betsy Ross made the first flag as a favor to George Washington. Historians dispute this, however. Another disputed story is that the first flag faced enemy fire at Fort Schuyler in August 1777. Someone made a flag in the fort from a soldier's white shirt, a captain's blue coat, and the red petticoat of a young lady. This was probably a flag different from the Stars and Stripes.

The Continental Congress passed a resolution on June 14, 1777:

That the flag of the thirteen United States be thirteen stripes, alternate red and white: that the union be thirteen stars, white in a blue field, representing a new constellation.

They did not say how the stars should be arranged. The first army flag had the stars in a circle. When the army first flew the flag, General George Washington was supposed to have said:

We take the stars from heaven, the red from our mother country, separating it by white stripes, thus showing that we have separated from her. The white stripes shall go down to posterity representing Liberty.

After Kentucky and Vermont were added to the Union, Congress added to the flag in 1794 so that it had 15 stars and 15 stripes. In 1818, realizing the design would be cumbersome with the addition of more states; Congress ordered a return to 13 stripes for the original colonies. A star was to be added for each new state on the fourth day of July after its admission to the Union. The

sixteenth star was added for Tennessee in 1796. A 48-star flag came into being after Arizona and New Mexico were added in 1912. The 49th and 50th stars were added in 1959 and 1960 for Alaska and Hawaii, respectively.

Old Glory is the symbol citizens encounter most often. There are strict rules on how this important symbol should be properly displayed, cared for, and used. In the summer of 2001, the House of Representatives passed a constitutional amendment that would return to the Congress the right to protect the U.S. flag from acts of physical desecration. The Senate must, by a 2/3-majority, pass the amendment if it is to go to the states for ratification. Forty-nine states have passed resolutions petitioning Congress to send them a flag-protection amendment. Three-fourths of the states would have to ratify the amendment before it could officially become the 28th amendment to the Constitution.

The Pledge of Allegiance

The wording of the pledge varies slightly from the original, which was written in 1882 in the office of *The Youth's Companion* magazine in Boston. It was first used in the public schools in celebration of Columbus Day, October 12, 1892. Congress adopted the pledge in an act approved on June 22, 1942. Congress added the phrase “under God” in 1954.

“I pledge allegiance to the flag of the United States of America, and to the republic for which it stands, one nation under God, indivisible, with liberty and justice for all.”

The National Anthem

In September 1813, the British attacked Baltimore, Maryland. Their ships sailed up the Chesapeake Bay and entered Baltimore harbor, which was protected by Fort McHenry’s battery of guns and cannons. Francis Scott Key, a Washington lawyer, had gone aboard a British ship to negotiate the release of a prisoner. Unfortunately, he was detained on the ship when the fighting began. Just before dawn the fighting stopped. As the sun rose, Key could faintly see above the fort the flag of the United States. He was proud his young nation had not lost this battle in the War of 1812. He began writing a poem called “The Defense of Fort McHenry,” that later became known as the “The Star-Spangled Banner,” on an envelope while he was still aboard the British ship. Later, back in his hotel, he completed it.

The song was sung and the music played for years. In 1916 it was called our national anthem, and Congress confirmed this in 1931. The first of the four verses of the Star-Spangled Banner is the one usually sung to demonstrate patriotism at gatherings.

Oh, say can you see, by the dawn’s early light,

What so proudly we bailed at the twilight’s last gleaming?

Whose broad stripes and bright stars, through the perilous fight,

O’er the ramparts we watched were so gallantly streaming?

*And the rockets’ red glare, the bombs bursting in air,
Gave proof through the night that our flag was still there.*

Oh say, does that star-spangled banner yet wave

O’er the land of the free and the home of the brave?



The Liberty Bell

The Liberty Bell was rung with other church bells in July 1776 to announce the adoption of the Declaration of Independence. It was rung each year thereafter to celebrate the anniversary. The colony of Pennsylvania purchased the bell for \$300 in 1752 after it was cast in England. Unfortunately, it cracked soon after its arrival and was recast in Philadelphia with the same metal. An inscription from Leviticus 25:10 was engraved on the bell: “Proclaim Liberty throughout all the land unto all the inhabitants thereof.”

On July 8, 1835, the bell broke again when it was being tolled during the funeral procession of Chief Justice John Marshall. The bell was silenced at that time and was never recast.

The bell became known as the “Liberty Bell” about 1839 when people advocating the abolition of slavery for all Americans used it as a symbol. It hangs today in a pavilion across the street from Independence Hall in Philadelphia, Pennsylvania.

The Washington Monument

Visitors flying into our nation’s capital are first likely to notice the Washington Monument. Almost 556 feet tall, the Washington Monument towers over the city. Its white marble is beautiful in sunlight and shines at night in the reflection of floodlights.



The idea of a national monument to honor George Washington, a general during the Revolutionary War and our first President, began in 1833. A contest was held encouraging architects to design the monument. By 1836 the design was set, but construction did not begin until 1847. Only 156 feet of the structure had been built by 1858. Work was halted for 20 years as the nation was caught in the turmoil of the Civil War. Building began again in 1878, and in December 1884 the monument was finally finished.

Millions of visitors to Washington, D.C., have climbed the stairs or taken elevators to the top of the Washington Monument. It is a famous landmark in our capital. It is a symbol of our respect for George Washington.

Conclusion

There are many other monuments and works of art, music, and literature that evoke feelings of patriotism. Among them are the Lincoln Memorial, the Capitol, the Gettysburg Address, the Declaration of Independence, the song “God Bless America,” the Statue of Liberty, and many more. The list is quite long and growing each day. These symbols are an important part of our national culture and heritage. They are part of what it means to be an American.❖

Rights, Responsibilities, and Privileges

PURPOSE

*The first ten amendments to the Constitution of the United States are collectively known as the **Bill of Rights**. These amendments identify the basic freedoms and rights guaranteed to all American citizens. The purpose of this lesson is to explore these rights in greater detail.*

Each American citizen has rights and responsibilities that go hand in hand with our democracy. Because of our democratic form of government, we enjoy freedoms and rights that do not exist in other countries.

The Bill of Rights

The United States is a **representative democracy**: a government under which voters elect their representative. In this sense, the United States is, as Abraham Lincoln said, “A government of the people, by the people, and for the people.”

When the framers of the Constitution met in Philadelphia and wrote the document that serves as the supreme law of the land, they wanted to ensure that government would not attain too much power. The Constitution included a series of checks and balances between the executive, legislative, and judicial branches. The Constitution also established a separation of power between the branches of government. However, many of those involved in the discussion of the document felt that it was fatally flawed because it did not include written protection for the rights of the people. It

specified what the government could do, but did not say what it could not do.

The absence of a “bill of rights” turned out to be an obstacle to the ratification of the Constitution by the states. For the next four years there was intense debate about what form the new government would take. The Federalists, including George Washington, Alexander Hamilton, and John Adams, opposed including a bill of rights on the grounds that it was unnecessary. Well-known colonists like George Mason and Patrick Henry of Virginia actively campaigned against ratification. Anti-Federalist Thomas Jefferson argued that, “A bill of rights is what the people are entitled to against every government on earth, general or particular, and what no just government should refuse.”

The American Bill of Rights, inspired by Jefferson and drafted by James Madison, was accepted as the first ten amendments to the Constitution in 1791. It was the guarantee of the individual freedoms identified in the Bill of Rights that enabled the state legislatures to agree to ratify the Constitution.

Many people feel that their constitutional rights are absolute (without limitations). Other people weigh these rights against the need to preserve order in America. Our nation has seen a constant disagreement of majority rule and minority rights. However, the Constitution provides a balance that allows majority rule while protecting the rights of all.

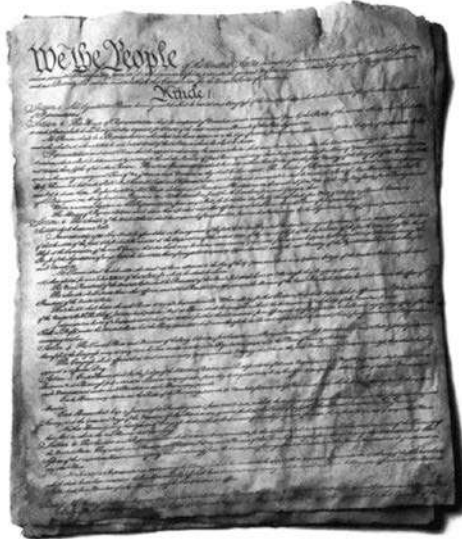

The First Amendment – Religious and Political Freedom

“Congress shall make no law respecting the establishment of religion, or prohibiting the free exercise thereof; or abridging the freedom of speech, or of the press; or the right of the people to peaceably assemble, and to petition the Government for redress of grievances.”

Freedom of Religion

The first right guaranteed in the *Bill of Rights* is the freedom of religion. Religious freedom was important to the colonists because the religious intolerance that many had experienced in Europe caused them to migrate. Many experienced that same intolerance in America.

The First Amendment contains laws that protect the religious freedom of the citizens: the establishment clause and the free exercise clause. Both of these clauses apply to state and local governments.

The establishment clause states that the government can neither impose a specific religion nor can it prevent the practice of a specific religion. This amendment prohibits the government from setting up an official or established church and prevents it from passing laws that would aid one or all religions or that would show preference for one religion over another.

The free exercise clause states that citizens are free to join any religious body (or none at all) and that each religious body is free to practice its own beliefs and form of worship, without government interference.

Freedom of Speech

Freedom of speech is the right to say (express orally your thoughts, ideas, or opinions) the truth about anything.

However, there are important limitations to the freedom of speech. If false or harmful statements unjustly damage someone’s reputation, the person about whom the statements were made may sue the speaker in a court of law. Additionally, you do not have the right to use your freedom of speech to cause someone physical harm. For example, you do not have the right to yell “Fire” in a building just to see what happens.

Within these limitations, citizens can discuss any question or express their ideas or opinions about anyone or anything freely, even to criticize the government or the president.

Freedom of the Press

Freedom of the press is the right to write, print, or publish truthful thoughts, ideas, or opinions about anything. The press includes magazines, newspapers, books, television, radio, movies, and other forms of communication. You cannot use this freedom to make false statements,

but you can use it to report any true incidents or violations including those within government agencies.

Freedom of Assembly

Freedom of assembly gives you the right to hold meetings and gatherings. This freedom allows Americans to come together, peaceably, for business or pleasure, to listen to speeches, stage demonstrations, or organize protest marches. However, the government (primarily local or state) can require individuals or groups to obtain permits before they speak or demonstrate on public property and can deny permission to assemble if it considers the assembly unreasonable or unconstitutional.

Freedom of Petition

Freedom of petition is the right to ask the government to take action -- or not to take action -- on something without fear of penalty. For example, you have the right to write your state representative in Congress and to ask him/her to work on, pass, or modify certain laws.

The Second Amendment – The Right to Bear Arms

“A well regulated militia, being necessary to the security of a free State, the right of the people to keep and bear arms, shall not be infringed.”

The Second Amendment prevents the government from prohibiting ownership of weapons by citizens. The framers of the Constitution did not foresee the ability of the United States to have a standing army with the rapid deployment capabilities of our modern armed forces. For that reason, a militia composed of ordinary citizens was essential to the new nation’s security.

The Second Amendment is extremely controversial. One side of the issue maintains that gun control laws such as registration, waiting periods, and banning of the sale of some types of weapons restricts but does not prohibit gun ownership. On the other hand, there are people who feel that the Second Amendment gives everyone the right to own or purchase a gun without restriction, and that the government cannot pass laws to take that right away.

The Third Amendment – Quartering of Soldiers

“No soldier shall, in time of peace, be quartered in any house, without the consent of the owner, nor in time of war, but in a manner to be prescribed by law.”

Congress added this amendment to the Bill of Rights to ensure the government could never force its citizens to house (or quarter) soldiers in their homes during peacetime without the owner’s consent. During colonial times, it was not an unusual practice to have British soldiers literally move into the homes of the colonists.

The Fourth Amendment – Search and Seizure

“The right of the people to be secure in their persons, houses, papers, and effects against unreasonable searches and seizures, shall not be violated, and no warrants shall issue, but upon probable cause, supported by oath or affirmation, and particularly describing the place to be searched, and the persons or things to be seized.”

This amendment limits the government’s power to search and to take custody of a citizen’s property. Courts require a search warrant and probable cause to conduct a legal search. Warrant means “justification” and refers to a document issued by a magistrate judge indicating the name,

address, possible offense committed, and property to be seized.



The Fifth Amendment – Criminal Proceedings and Due Process

“No person shall be held to answer for a capital, or otherwise infamous crime, unless a presentment or indictment of a Grand Jury, except for cases arising in the land or naval forces, or in the militia, when in actual service in time of war or public danger: nor shall any person be subject for the same offense to be twice put in jeopardy or life, liberty, or property, without due process of law; nor shall private property be taken for public use, without just compensation.”

The Fifth Amendment gives all citizens accused of major crimes the right to have their cases considered by a **grand jury** before the prosecution can take it to trial.

The Fifth Amendment also states that if a court tried and acquitted a citizen in a criminal case, another court may not try that citizen again for the same offense. This right is known as the protection against **double jeopardy**. However, individuals who have been acquitted of a crime in

criminal court may be sued for the offense in a civil court.

People cannot be made to testify against themselves. This protection against “self-incrimination” is often waived when the accused wishes to take the stand to defend themselves.

The last two sections of this amendment provide protection against the violation of **due process** and the arbitrary confiscation of property. The “due process” clause means that the courts must extend all protections in the Bill of Rights and in the Constitution to a person accused in a criminal action. Next, it gives all Americans the right to own private property. The government cannot take private property for public use without paying a fair price for it. The government’s power to take private property for public use is called eminent domain.

The Sixth Amendment – The Right to a Trial by Jury

“In all criminal prosecutions, the accused shall enjoy the right to a speedy and public trial by an impartial jury of the State and district wherein the crime shall have been committed, which by district shall have been previously ascertained by law, and to be formed of the nature and cause of the accusation; to be confronted with the witnesses against him; to have compulsory process for obtaining witnesses in his favor, and to have the assistance of counsel for his defense.”

Trial by jury is one of the cornerstones of the American legal system. Accused persons may usually waive this protection if they so choose. If, on the other hand, they demand a trial by jury, twelve jurors must reach a unanimous verdict in order to convict. This amendment also guarantees citizens the right to a prompt and public trial. Arresting officers must inform people of the crime with which they are charged. During the

trial, they have the right to hear and question all witnesses against them and to call witnesses to appear in court. Also, accused persons have the right to a lawyer.

The Seventh Amendment – The Right to a Civil Trial

“In suits at common law, where the value in controversy shall exceed twenty dollars, the right of a trial by jury shall be preserved, and no fact tried by a jury, shall be otherwise reexamined in any court of the United States, than according to the rules of the common law.”

Americans have the right to a trial by jury in certain cases where there is a dispute over money or property.



The Eighth Amendment – Punishment for Crimes

“Excessive bail shall not be required, nor excessive fines imposed, nor cruel and unusual punishment inflicted.”

Bail is the money (or property) given to a court by an accused person in order to guarantee that person will appear for the trial. This amendment states that bails cannot be set at unreasonable amounts. It has also been interpreted to mean that the amount of bail

should fit the seriousness of the crime. Paying bail allows the person to be out of jail. Courts return the bail at the end of the trial. This amendment also states that courts must not give fines and punishments that are cruel, excessive, or unusual.

The Ninth and Tenth Amendments – Other Rights

“The enumeration in the Constitution, of certain rights, shall not be construed to deny or disparage others retained by the people.”

“The powers not delegated to the United States Constitution, nor prohibited by it to the States, are reserved to the States respectively, or to the people.”

Simply stated, the Ninth Amendment indicates that the rights listed in the Constitution are not the only rights Americans have. The Tenth Amendment grants to the states and the people the powers not expressly given to the federal government or forbidden to the states or the people in the Constitution.

Conclusion

Congress added the Bill of Rights to the Constitution to prevent the government from limiting the rights of its citizens. The freedoms described in the first eight amendments, the other rights implied in the Ninth Amendment, and the reserved powers belonging to the states and the people by the Tenth Amendment are basic rights that the government cannot deny or take away from American citizens. ❖

Attaining Citizenship

PURPOSE

The lesson on attaining citizenship begins with the poem that is found on the base of the Statue of Liberty. After you have read and discussed the poem, you will learn how those “tempest-tost, yearning to be free” become U.S. citizens and how citizenship is granted in the United States.

The New Colossus

“Not like the brazen giant of Greek fame,
With conquering limbs astride from land to land;
Here at our sea-washed, sunset gates shall stand
A mighty woman with a torch, whose flame
Is the imprisoned lightning, and her name
Mother of Exiles. From her beacon-hand
Glow *world-wide welcome*; her mild eyes command
The air-bridged harbor that twin cities frame.
“Keep ancient lands, your storied pomp!” cries
she
With silent lips. “*Give me your tired, your poor,
Your huddled masses yearning to breathe free,
The wretched refuse of your teeming shore. Send these, the
homeless, tempest-tost to me,*
I lift my lamp beside the golden door!”

Emma Lazarus



Becoming an American Citizen

Legal Basis for U.S. Citizenship

The qualifications for U.S. citizenship have changed as this country has matured. At the time the Framers wrote the Constitution, citizenship was the states’ responsibility. A person who was a citizen of a state was also a citizen of the United States. The government made exceptions for immigrants who became citizens by **naturalization**.

The Fourteenth Amendment provides that, “All persons born or naturalized in the United States ... are citizens of the United States and the state in which they reside.” According to this amendment, children born in the United States, except those of foreign ambassadors, are automatically citizens. Two ways that we classify the **conferring** citizenship in the United States are known as ***jus soli*** and ***jus sanguinis***. *Jus soli* means the “law of the soil.” In other words, a person becomes a citizen by virtue of being born in the United States.

The conferring of citizenship by *jus sanguinis* (or the “law of the blood”) applies to all children born to United States citizens, either male or female. In other words, if one or both of the parents are American citizens, the children have the right to American citizenship. These children are citizens regardless if their parents live in the United States or in another country. For example, children born to American parents serving in the military overseas may hold dual citizenship: they are citizens of the United States and can hold the citizenship of the country in which they were born. However, if one of the parents is not an

American citizen, then some residency restrictions may apply.

Naturalization

Citizens of other nations who seek citizenship in the United States can do so through a process called naturalization. Any court of law can grant this privilege. Those who wish to become “naturalized citizens” must simply demonstrate to the court that they have met all of the legal requirements set by Congress.

Prospective citizens must then **renounce** the citizenship of their former country and swear an oath of allegiance to the Constitution and to the laws of the United States.

Collective naturalization is a process whereby a group of individuals may become United States citizens without going through the normal process. Although naturalization is an official act by which people become nationals of one country other than their native one, it does not necessarily confer citizenship. Specifically, when Congress admits a territory as a new state, the citizens of that territory become American citizens. In another situation, if our government grants a foreign country the right to become a United States controlled territory, but without approving statehood, its citizens become nationals of the United States.

Immigration

Countries around the world often characterize the United States as being a “nation of immigrants.” In fact, many of our ancestors immigrated to this country seeking freedom and opportunity. But there are restrictions. Congress decides who this country will admit, under what conditions we will admit them, and since 1924, the

number of persons who can immigrate into the United States per year.

A 1990 **immigration** act set an annual limit, beginning in 1995, of 675,000 new entrants (excluding refugees and other special categories), of whom no more than seven percent can come from any one country.

Political refugees represent a special category of immigrants. In 1996, 120,000 political refugees were allowed to enter the United States.

Undocumented aliens are people who enter into and remain in the United States in violation of immigration laws. An estimated five million undocumented aliens were living in the United States in 1996 and are estimated to be growing by 275,000 annually.



Qualifications for U.S. Citizenship

The 1952 *McCarran-Walter Immigration and Nationality Act* (as amended in 1965) established the following qualifications for United States citizenship:

- Has entered the United States lawfully for permanent residency
- Is of good moral faith

- Agrees to support the principles of the government of the United States
- Is able to read, write, and speak the English language
- Is able to demonstrate a knowledge of American history and government
- Is able to demonstrate a dedication to American values, which includes not being a member of a subversive organization such as a communist party.

To obtain citizenship, one must:

- File a petition
- Attend an Immigration and Naturalization Service Hearing with two witnesses
- Attend a final hearing to have an official administer the oath of citizenship

In order to file a petition, the person must be at least 18 years old. Further, that person must have: 1) lived in the United States for the past five years continuously and resided in a state for six months before filing, or 2) lived in the United States for three years if married to an American citizen.

Conclusion

Becoming a citizen is often an accident of birth. However, there are millions of people each year who apply for visas in the hopes that one day they might be able to share in the benefits of American citizenship. Our country's history indicates that we are a nation of immigrants. In many ways, it is the diversity of our people that makes us strong and unique. ❖

Volunteerism

PURPOSE

*In more and more school districts across the nation, students are being asked to provide as many as eighty hours of community service before they can receive a high school diploma. While required community **service** can provide worthwhile experiences for students, it should not be confused with **volunteerism**, which has three distinct features. First, volunteers act by their own choice. Secondly, volunteers provide a valuable service that the recipients would otherwise have to pay to receive. Thirdly, volunteers provide their service free of charge and with no personal reward other than the benefits they might receive from doing their activity.*

volunteered for an activity did it multiple times. In fact, approximately sixty-five per cent of those students said that they volunteered in this current school year.



Introduction

The following article was written by Hanna Gordola, a student at Forbush HS in Yadkin County, North Carolina, and appeared in the student newspaper, “The Tale Feathers.” In the article, she identifies a number of reasons why cadets can benefit from volunteerism.

“The majority of adults believe that young people these days are selfish and unconcerned about the world around them. They believe that teens only care about their social status and that they could not care less about the less fortunate. The truth is, teens are concerned and do care for others. Over half of the three hundred eighty Forbush students surveyed said that they have volunteered before. Most of the people that

There are many reasons why students should volunteer. One reason is that *volunteering helps others*. Various people said that they help in soup kitchens once in a while, and others have said that they visit senior citizens at the nursing home. Simple acts like these really do make a difference.

“Patients love it when young people read to them,” said head activity director Crystal Watkins of Yadkin Nursing Care Center, Inc., in Yadkinville. “They enjoy having young people listen to their stories of how they used to live and what life used to be like.”

Another reason that students should volunteer is the personal benefit that they may

Category 2 – Citizenship
Skill 2 – Civic Responsibility

gain. “*After I volunteer, I always feel good,*” said sophomore Adam Prim. “I try to do it as much as I can.”

They [volunteers] always say that they feel blessed after they volunteer. And they’re never bored here because no day is ever the same. “There’s always something new,” said Watkins.

In contrast to the personal rewards of volunteer work, a practical benefit is that *volunteer jobs look good on college applications.*

“Most colleges do look for students who have volunteered,” commented Vice-Principal Mrs. Jones.



College and university recruiters consider the good character traits of perspective students when they read an application. Having volunteer jobs listed on your application definitely shows you as a caring person one who would be an asset to their school.

Our seniors appear to be aware of how their character is perceived when applying to college. About eighty percent of the seniors surveyed said that they have volunteered before, and a large number of them, approximately eighty-six percent, volunteered within this school year.

Subsequently, the survey indicated that as students of Forbush High School get older and nearer to their graduation, the percentage of students who have volunteered got higher. In comparison to the eighty percent of seniors who volunteer, only forty-six percent of freshmen have ever volunteered.”

There are a good many other reasons why volunteerism is a benefit. Because volunteerism keeps teams occupied, students who volunteer are less likely to abuse drugs. They are likely to do well in school, vote in elections, and gain an understanding of civic responsibility.



Volunteer work provides a great benefit to the community. Billions of dollars are saved each year when volunteers provide services that would otherwise cost money to the city, state, or federal government. People who volunteer are better able to understand their role as citizens of a community. Volunteers are also able to practice their learned skills and even take on leadership roles.

Conclusion

The act of volunteering implies choice. Depending on how much time an individual has, they can volunteer a little or a great deal. No

Category 2 – Citizenship
Skill 2 – Civic Responsibility

matter, the voluntary service provided will always provide a benefit to the community and a sense of accomplishment to the volunteer. ❖

Physical Training: The Daily Sixteen

PURPOSE

The Marines define physical fitness to include, “a healthy body, the capacity for skillful and sustained performance, the ability to recover from exertion rapidly, the desire to complete a designated task, and the confidence to face any situation.”

Being physically fit means different things to different people. One person may claim to be in great physical shape while another would consider the same conditioning level as just adequate. Certainly, those involved in a fitness program achieve and maintain a different level of fitness based on their effort, regularity, and type of physical training (PT).

Despite the differences in definitions, physical fitness has several benefits for everyone. Among these benefits are improved muscle tone, cardio-respiratory endurance, and flexibility. People also achieve body weight regulation, improved quality of sleep, and reduced mental tension and emotional stress.

3. Decreasing body fat;
4. Improving movement in your joints and muscles; and
5. Improving your sense of well-being.

No one is too young or too old to exercise. However, there are risks to strenuous exercise. For more information, discuss these potential hazards with a physician. The American Heart Association recommends the following:

- Healthy individuals should engage in 30-minute or longer workouts at least three or four times per week. Exercising more than five times a week for 10 to 24 minutes each session is even better.
- People over 45 who have not had a physical exam in two years or longer, people with serious or chronic medical conditions or who are at risk for heart disease, and people on medication should consult a physician before embarking on a serious exercise program.
- One-half of all people who begin a vigorous training regime drop out within a year. The key to attaining and maintaining physical fitness is to find activities that are exciting, challenging, and satisfying.

Introduction

General Guidelines for Achieving Physical Fitness

In general, there are five basic goals of exercise, including:

1. Improving oxygen delivery and **metabolic** processes;
2. Building your strength and endurance;

Four Components of Physical Fitness

There are four different components of physical fitness, each of which must be developed in a good training program: strength, endurance, agility, and coordination.

1. **Strength** is defined as the amount of force that can be exerted by the contraction of a muscle. You need sufficient strength not only

to perform routine activities, but also to cope with emergency situations.

2. Endurance is your ability to perform work over an extended period. There are two types of endurance: **muscular endurance** and **cardio-respiratory endurance**. Muscular endurance is the ability to either sustain contractions of the muscle (**isometric**), or to perform repeated contractions (**isotonic**) of the muscle. Muscular endurance is concerned with the capacity of a single muscle or group of muscles. The other type of endurance, cardio-respiratory endurance, refers to the entire body's capacity to perform sustained work. This depends mainly on the capability and efficiency of the **circulatory system** (the heart, lungs, and blood vessels).
3. **Agility** is the ability to control your body movement so that you can change directions quickly and efficiently. **Neuromuscular condition** is the primary ingredient in agility. When you practice special skills such as climbing, dodging, and jumping, you improve this condition.
4. **Coordination** is the ability to move all parts of your body in a smooth, efficient, and concerted manner. It is a measure of how efficiently your body performs an action. When an unskilled performer attempts a movement, much of the energy expended is wasted through unnecessary effort. After some practice, less energy will be required, not because the task is easier, but because only those muscle groups required to do the job are used – the waste is eliminated. This “learning effect” results in a gain in performance without an increase in strength or endurance.

Although professional athletes often specialize in one component at the expense of the

others, to achieve a well-round state of physical fitness, you should work to develop all four components of physical fitness.

Stages of Conditioning

Many people fail to realize that improving your level of fitness takes much more than just exercising a few days in a row. Some people even think you can achieve improvement overnight. Unfortunately, this is not true, as you may have already discovered. No matter what program you choose to follow, everyone's body develops at its own pace. If you try to exceed what is your body's pace, you will experience unnecessary pain, frustration, and possibly even injury. The conditioning process consists of three distinct phases: preparatory, conditioning, and maintenance.

Preparatory Phase

This first stage lasts for about two weeks. During this phase you may experience sore stiff muscles, but do not be discouraged. Hang in there! Keep in mind how well you will feel once you reach your goal of a physically fit body.

The muscle soreness you experience in this phase is the result of irritation in muscle tissue caused by a build-up of acidic waste products. As time passes and your exercise program continues, your circulatory system adapts to the increased demand and is able to remove waste products more efficiently. The soreness disappears.

Conditioning Phase

As your body passes through the preparatory phase and continues into the conditioning phase, the volume of blood circulating in your muscles increases and your body functions more efficiently. In the first few weeks of this 6- to 10-week phase, you will see

rapid improvement. However, as you reach a higher level of skill and conditioning, your improvement will be less noticeable.

Maintenance Phase

The maintenance phase is the final phase of physical conditioning. During the first two phases, your body reached a level of physical conditioning close to or at peak condition. In some cases, this level may be a plateau beyond which you may progress only through continued rigorous physical training. However, for most people, it is really only necessary to continue exercising at approximately the same level you exercised in the conditioning phase. By exercising at approximately the same intensity, you will retain the level of conditioning you have developed.

Principles of Conditioning

There are a number of things to keep in mind as you work on improving your physical fitness:

- If you are just beginning a PT program, you must go through all three phases. No extra amount of effort or motivation can change that cycle. Structure your program to gradually increase the demand you make on your body in order to perform at higher levels.
- You will not see any improvement unless you push your body beyond its normal level of performance. For example, if you are trying to improve your 3-mile run from 25 minutes to 20 minutes, it will not help if you are only running one mile in 10 minutes. You need to push yourself to decrease the time it takes you to run a mile so that you are running a mile in less than 7 minutes.
- To achieve physical fitness in all four components of fitness, include activities that

work to achieve the results you want in strength, endurance, agility, and coordination.

- To have a successful program, you must include a variety of competitive events and skill development exercises. A boring, repetitive program usually fails because you lose interest in what you are doing.
- Exercising on a regular basis is critical for success. Most experts agree that you need at least 15 days to establish a habit – and unless regular exercise is your habit, you will not achieve the level of physical fitness you want.

Heart Rate Goal

Ideally, when you exercise, you should try to keep your heart rate at roughly 70% to 85% of its maximum rate. Keep in mind that exercise does not *increase* your maximum heart rate. Exercise strengthens your heart so that it can pump more blood at this maximum level and can sustain this level longer with less strain.

It is easy to determine your own maximum heart rate per minute. All you need to do is simply subtract your age from 220.

$$220 - \text{age (years)} = \text{maximal heart rate.}$$

To determine how intensely you are working out, you also need to calculate your resting heart rate (the rate at which your heart beats when you are performing your normal, everyday activities). The easy way to determine your resting heart rate is use the 10-second method:

- Measure your pulse by gently pressing the first two fingers of one of your hands on either the artery on the inside of your other wrist or on a **carotid artery** (located under your jaw either on the right or left side of the front of your neck).

U.S. MARINE CORPS. JROTC
Category 3 – Personal Growth and Responsibility
Skill 1 – Physical Fitness

- Count pulse beats for 10 seconds.
- Multiply the result by six. This gives you your per-minute total for your resting heart rate.

Now you need to calculate the higher and lower limits of your heart rate. Here are the formulas to do so:

- Maximal heart rate - resting heart rate = working heart rate
- Working heart rate x .60 + resting heart rate = lower limit
- Working heart rate x .80 + resting heart rate = upper limit

Since heart rate (beats per minute) is directly related to exercise intensity (the harder you exercise, the higher your heart rate), checking your heart rate during exercise is a good way to measure your exercise intensity.

You should measure your heart rate after the first 5 minutes of exercise and approximately every 10 minutes thereafter until you get a good feel for the appropriate exercise intensity. If your heart rate is lower than your lower limit heart rate, you need to increase your intensity level. If it is higher than your upper limit, you will probably not be able to continue for more than 20 minutes and you need to decrease your intensity level.

10 Second Heart Rate	Heart Rate (Beats Per Minute)
17	102
18	108
19	114
20	120
21	126
22	132
23	138
24	144
25	150

Here is an example for an average 20-year-old. This individual determined his resting heart rate was equal to 70 beats per minute. With this information, he determined that his working heart rate was equal to 130. You can see from the last two calculations, he also determined his lower (148) and upper limits (174).

$$220 - 20 = 200 \text{ (maximal heart rate)}$$

$$200 - 70 = 130 \text{ (working heart rate)}$$

$$130 \times .60 + 70 = 148 \text{ (lower limit)}$$

$$130 \times .80 + 70 = 174 \text{ (upper limit)}$$

From the example you can see that the target heart rate for our 20-year-old is **148 to 174** beats per minute. Therefore, for health purposes, the recommendations for this person would be to perform an aerobic exercise (such as running) for at least 20 minutes, 3 to 4 times per week at an intensity that results in a heart rate of 148-174 beats per minute. (As you will see later in this chapter, the general recommendation for aerobic exercise is 3 to 4 times per week.)

Rules for Any Exercise Method

There are a few simple rules you need to follow when developing your own exercise program or following a program through school or at a gym:

- Do not eat two hours before vigorous exercise.
- Drink plenty of fluids before, during, and after a workout.
- Adjust your activity according to the weather and reduce it when you feel fatigued or ill.
- When exercising, listen to your body's warning symptoms! If you experience chest

pain, irregular heartbeat, undue fatigue, nausea, unexpected breathlessness, or light-headedness during exercise, be certain to consult your doctor.

Warm-Up and Cool-Down Period

Warming up and cooling down are important parts of any exercise routine. They aid the body in making the transition from rest to activity and back again and can help prevent soreness or injury.

Warm-Up

The warm up allows a gradual redistribution of blood flow to the muscles, preparing both the cardiovascular and musculovascular systems for the exercise session. The increased blood flow to the muscles produces a warming effect, increasing the **elasticity** of the muscle and connective tissues, which is believed to reduce injury risks.

Warming up before you begin to exercise can help to prevent injuries and may enhance performance. A good rule of thumb is to warm up with low intensity versions of the exercise that you are about to begin. For example, before attempting a set of heavy bench presses you might do a couple of light sets first with some stretching. Before a hard run you might do a light ¼ mile and then stretch. Remember that you should always warm up before you stretch. An appropriate order would be to warm up, stretch, and then begin to exercise.

Warm-up exercises should be practiced for 10 to 15 minutes at the beginning of an exercise session. These exercises should employ large muscle groups and gradually progress to the conditioning activities. Walking briskly, swinging

your arms, or jogging in place (considered low-level aerobic exercise) are perhaps the best types of warm-up activities.

Cool-Down

The cool-down allows the body to gradually return to the resting state. To cool down, walk slowly until your heart rate is 10 to 15 beats above your resting rate. Stopping too suddenly can sharply reduce your blood pressure and may cause muscle cramping. Like the warm-up, the cool-down should last a minimum of 10 to 15 minutes. Cool down using the same large muscle groups used in the warm-up, gradually decrease in intensity, and finish with stretching exercises targeting all major muscle groups.

Stretching is appropriate for the cooling down period, but not for warming up because it can injure cold muscles. Particular exercises may require stretching specific muscles. For example, a jogger or biker might emphasize stretching the hamstrings, calves, groin, and quadriceps, while swimmers would focus on the groin, shoulders, and back.

Aerobic or Endurance Training

The word “aerobic” means “with oxygen.” During aerobic exercise, our bodies consume large quantities of oxygen. Consuming large quantities of oxygen places great demands on the respiratory system, the heart and the circulatory system (heart and blood vessels). Because it places great demands on these systems, aerobic exercises induce improvements in these systems. Aerobic exercise can be defined as any exercise that involves a large amount of muscle mass, is continuous and rhythmic in nature, and can be continued for at least 20 minutes non-stop. Good examples are running, swimming, walking, skating, jumping rope, and aerobics classes.

Benefits of Aerobic Exercise

Regular aerobic exercise provides the following benefits:

- Builds your endurance;
- Keeps your heart pumping at a steady and elevated rate for an extended period, boosts high-density lipoprotein (HDL), the “good” cholesterol levels, and helps control your blood pressure;
- Strengthens the bones in your spine;
- Helps maintain your normal weight; and
- Improves your sense of well-being.

Types of Aerobic Exercise

Aerobic exercise is usually categorized as high or low impact. Examples of each include the following:

- Low to moderate impact exercises include walking, swimming, stair climbing, step classes, rowing, and cross-country skiing. Nearly anyone in reasonable health can engage in some low to moderate impact exercise. Some research indicates that simply walking briskly for three or more hours a week reduces the risk for coronary heart disease by 65%. Brisk walking also burns as many calories as jogging for the same distance and poses less risk for injury to muscle and bone.
- High impact exercises include running, dance exercise, tennis, racquetball, and squash. Perform high-impact exercises no more than every other day and less if you are overweight, elderly, out of condition, or have an injury or other medical problem that would preclude high-impact.

Aerobic Regimens

As little as one hour a week of aerobic exercises is helpful, but three to four hours per week will achieve **optimal** results. The following guidelines are useful for most individuals:

- For most healthy young adults, the best approach is a mix of low and higher impact exercise. Two weekly workouts will maintain fitness, but three to five sessions a week is better.
- People who are out of shape or elderly should start aerobic training gradually with five to ten minutes of low-impact aerobic activity every other day and build toward a goal of 30 minutes per day, three to seven times a week. (For heart protection, frequency of exercises may be more important than duration.)
- Swimming is an ideal exercise for many people with certain physical limitations, including pregnant women, individuals with musculoskeletal problems, and those who suffer from exercise-induced asthma.
- People who seek to lose weight should aim for six to seven low impact workouts a week.
- One way of gauging the optimal intensity of exercise is to aim for a “talking pace,” which is enough to work up a sweat and still be able to talk with a friend without gasping for breath. As your fitness increases, your “talking pace” will become faster and faster.

Shoes and Clothing

All that is necessary for a workout, is a good pair of shoes, well made, well fitting, and broken in but not worn down. They should support your ankles and provide cushioning for impact sports such as running or aerobic dancing. Airing out your shoes and feet after exercising

reduces chances for getting skin conditions such as athlete's foot.

Comfort and safety are the key words for workout clothing. For outdoor nighttime exercise, wear a reflective vest and light-colored clothing. Bikers, rollerbladers, and equestrians should always wear safety devices such as helmets, wrist guards, and knee and elbow pads. Goggles are mandatory for indoor racquet sports. For vigorous athletic activities, such as football, ankle braces may be more effective in preventing ankle injuries than tape.

Shoes for Sports

Different types of exercise require different shoes in order to protect your feet and ankles.

For aerobic dancing, look for shoes that have sufficient cushioning to absorb the shock and pressure that is many times greater than ordinary walking. You also want shoes with arches that maintain side-to-side stability. Tennis coaches also recommend shoes with thick, upper leather support.

For running, as with aerobic dancing, you need shoes that provide sufficient cushioning to absorb shock and pressure. In addition, running shoes should be fully bendable at the ball of the foot and offer sufficient traction on the sole to prevent slipping.

If you prefer walking as your aerobic exercise, you want lightweight shoes that offer breathable upper material – either in leather or mesh. Walking shoes need to be wide enough to accommodate ball of your foot and have a firm padded heel counter that does not bite into your heel or touch your anklebone. The best walking shoe has a low heel close to the ground for

stability. Remember to get a shoe with good arch support.

Cycling shoes should provide rigid support across the arch of your foot to prevent collapse during pedaling.

For playing tennis, wear shoes that allow side-to-side sliding. Proper tennis shoes have a low-traction sole and a snug fitting heel with cushioning. You also want shoes with a padded toe box that offers adequate depth to ensure your toes have plenty of room. A soft-support arch in tennis shoes is also a must.

What about Equipment?

The following are a few observations on equipment for endurance or aerobic exercise:

- A simple jump rope improves aerobic endurance for people who are able to perform high impact exercise. You should only jump rope on surfaces that have some give to avoid joint injury.
- If you are looking for an exercise that burns calories, the treadmill has been ranked best, followed by stair climbers, the rowing machine, cross-country ski machine, and the stationary bicycle.
- Elliptical trainers may be even better than treadmills for elevating heart rate and increasing calorie expenditure and oxygen consumption.

Isometric -- Strength or Resistance Training

Benefits of Isometric Exercise

While aerobic exercise increases endurance and helps the heart, it does not build upper body strength or tone muscles. Isometric,

or strength-training, exercises provide the following benefits:

- Builds your muscle strength while burning fat;
- Helps you maintain bone density;
- Improves digestion; and
- Appears to lower high-density lipoprotein (LDL), the so-called “bad” cholesterol levels.
- Isometric exercise is beneficial for everyone, even people in their 90’s. In fact, strength training becomes even more important as you grow older. This is because after age 30 everyone undergoes a slow process of muscular erosion. This erosion can be reduced or even reversed by adding resistance training to an exercise program.

Strength-Training Regimens

Strength training involves intense and short-duration activities. It involves repetitions. You need to move specific muscles in the same pattern against a resisting force (such as a weight) for a preset number of times. To achieve a balanced exercise program, it is important to include 10 to 20 minutes of modest strength training two to three times a week.

Keep in mind the following guidelines as you start an isometric regimen:

- In the beginning, most people can start with one set of 12 to 15 repetitions per muscle group.
- Choose a weight that is about half of what would require a maximum effort in *one* repetition. In other words, if it would take maximum effort to do a single repetition with a 10 lb dumbbell, than you would start with a 5 lb dumbbell.
- Remember to breathe slowly and rhythmically. Exhale as you begin the

movement; inhale when you return to your starting point.

- The first half of each repetition typically lasts two to three seconds. The return to the original position lasts four seconds.

An alternative technique called “super slow” training stretches out one repetition to a 14-second count. This method places far more stress on the muscle group, so fewer repetitions are needed. A full week of recovery is required before repeating this workout. The goal is to initiate changes in the muscles so that the body continues to burn calories after the exercise. Some people report dramatic results from this approach, but scientific verification of these anecdotes is not available.

- Move your joints rhythmically through their full range of motion during a repetition and be certain not to “lock” your joints in place as you work with weights.
- For maximum benefit, wait 48 hours between workouts for full muscle recovery.

Strength-Training Equipment

Unlike aerobic exercise, strength training almost always requires some equipment. Strength-training equipment does not, however, have to cost anything. Any heavy object that can be held in your hand, such as a plastic bottle filled with sand or water, can serve as a weight. Many wearable weights are available to help strengthen and tone your upper body. Dumbbells (ranging in weight from 1 to 10 lbs.) and resistance bands, for example, are inexpensive, portable, and effective. You can use ankle weights to strengthen and tone the muscles in your lower body. Handgrips strengthen arms and are good for relieving tension. You can mount a pull-up bar in a doorway for chin-ups and pull-ups. Remember,

never purchase or use strength-training equipment without instruction from a professional.

Flexibility Training or Stretching

Flexibility is defined as being able to move your joints freely without restriction or pain through a wide range of motions. Muscles around your joints should be stretched regularly. A safe stretch is both relaxing and gentle. Move until you can feel the muscle stretch, holding the position approximately 30 seconds; relax and repeat if necessary. If you experience pain, stop doing the stretch. Remember to use slow, steady controlled movements. Do not bounce! Performing rapid or “ballistic” stretching is ineffective and can lead to injury. The muscle should be warm prior to stretching. The best way to accomplish this is to stretch following a low intensity warm up like jumping jacks or running in place.

Benefits of Flexibility Training

Flexibility training uses stretching exercises to achieve the following benefits:

- Flexibility training prevents cramps, stiffness, and injuries; and allow a wider range of motion
- Certain flexibility practices, such as Yoga and Tai Chi, also involve meditation and breathing techniques that appear to have many health and mental benefits.
- Certain stretching exercises are particularly beneficial for your back.

Flexibility Training Regimens

Authorities now recommend performing stretching exercises for 10 to 12 minutes at least

three times a week. Here are some general guidelines for stretching:

- When stretching, exhale and extend the muscles to the point of tension, not pain. Hold this position 20 to 60 seconds. If you are a beginner, you may need to start with a 5- to 10-second stretch and then gradually work up to longer times.
- Breathe evenly and constantly while holding the stretch.
- Inhale when returning to a relaxed position. Holding your breath causes your muscles to contract and raises your blood pressure. If you hold your breath, you defeat the purpose of stretching.
- When doing stretches that involve the back, it is important to relax your spine, to keep your lower back flush with the mat, and to work only the muscles required for changing position, usually your abdomen.

What Effect Does Exercise Have on Obesity and Weight Loss?

Exercising helps you reduce your weight, maintain weight loss, and can help fight obesity. However, the pounds will not melt off magically. It takes 35 miles of walking or jogging to burn the calories in one pound of fat! In addition, without dieting, you may only lose a few pounds with exercise alone because dense and heavier muscle mass replaces fat when you exercise. Even if you do not lose weight, however, remember that a fit body will look more toned and be healthier.

Here are some suggestions and observations on exercise and weight loss:

- The treadmill burns the most calories of standard aerobic machines. Exercise sessions

as short as 10 minutes in duration that are done frequently (about four times a day) may be the most successful program for overweight people.

- Even vigorous workouts do not immediately burn great numbers of calories. Your metabolism remains elevated after exercise; the more strenuous the exercise, the longer the metabolism continues to burn calories before returning to its resting level. This state of elevated metabolism can last for as little as a few minutes after light exercise, to as long as several hours after prolonged or heavy exercise.
- Resistance, or strength, training should be included in any regimen. If performed two or three times a week, strength training does a great job at replacing fat with muscles.
- Exercise improves your psychological well-being and replaces those **sedentary** habits that usually lead to snacking. Exercise may even act as a mild appetite suppressant. People who exercise are more apt to stay on a diet plan.
- You need to be aware that as you slim down, your initial level of physical activity becomes easier. As a result, you burn fewer calories per mile of walking or jogging. You may find that your rate of weight loss slows down after an initial dramatic head start using diet and exercise combinations. This can be very discouraging so you need to be aware of this and keep adding to your daily exercise regimen.

Warning Note

Because obesity is so often related to heart and other diseases, if you are overweight, you must discuss an exercise program with your doctor before starting.

Nutrition, Rest and Sleep

Although this chapter of your text focuses on physical fitness, remember that proper nutrition, as well as adequate amounts of sleep and rest are essential to your overall well-being.

Your body requires periods of relaxation and inactivity in order to recover from exertion and carry out normal metabolic functions. Even brief periods, such as 10-minute hourly breaks in a full day of physical activity, can produce dramatic results in terms of increased performance. Beyond such rest periods during daily routine, your body requires a certain amount of sleep each night to continue to function effectively. Although the amount of sleep an individual requires varies depending on your work and exercise load, eight hours of sleep per day is a good average to try to meet. Sleep requirements vary from person to person.

Your body needs essentially three basic types of food in addition to various vitamins and minerals, and adequate fluids. Each type of food offers different benefits. Carbohydrates serve as your body's chemical engine. Fats, which account for 11 to 18% of a normal person's body, serve as a reserve energy source stored within your body until it is needed. Proteins, which provide amino acids, serve as the material used for building the cells of your body.

The Daily Sixteen

The Daily 16 is a comprehensive warm-up, cool-down, and conditioning exercise program employed by the Marines. Command Cards use the 9 stretching and 7 conditioning exercises as the Daily 16; however, there are several warm-up exercises as well.

Warm-Up Exercises

The warm-up exercises include the following: toe heel rocking, partial squats, butt kicks, trunk bends, arm circles, prone row, supine lower body twist, and double time in place.

The following commands are used with the warm-up:

“Good morning _____ Company (or Series). We will begin today’s training session with a warm-up. Toe-heel rocking begin.”

1. No cadence or sounding off
2. 10 reps (2 count) or 10 seconds
3. Follow order on card
4. Perform in a “controlled” manner
5. Normal breathing

The following graphics provide a model for you to follow in performing each of the warm-up exercises:



TOE HEEL ROCKING



PARTIAL SQUATS

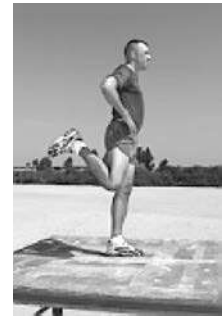

BUTT KICKS



TRUNK BENDS

ARM CIRCLES



PRONE ROW (on stomach)

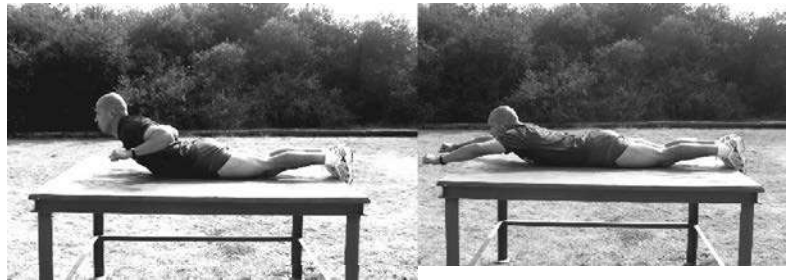

COUNT 1

COUNT 2



COUNT 3



COUNT 4 (arms/feet on the deck one second)

PRONE BODY TWIST (on back)



COUNT 3



COUNT 1



COUNT 4

COUNT 2



DOUBLE TIME IN PLACE



upper back, standing quadriceps, calf, hip flexor, groin (butterfly), and modified hurdler.

The following commands are used with the stretching exercises:

1. No cadence or sounding off
2. Hold 10 seconds warm up, 20-30 seconds for cool down
3. Follow order on card
4. Perform in a “controlled” manner
5. Breath normally; do not hold breath
6. Left side first, then “change over”

Stretching or Flexibility Exercises

The nine stretching exercises include the following: chest, triceps/side, posterior shoulder,

The following graphics provide a model for you to follow in performing each of the stretching exercises:



CHEST STRETCH



TRICEPS/SIDE STRETCH



POSTERIOR SHOULDER



UPPER BACK

STANDING QUADRICEPS STRETCH

CALF STRETCH



U.S. MARINE CORPS. JROTC
Category 3 – Personal Growth and Responsibility
Skill 1 – Physical Fitness



HIP FLEXOR STRETCH



GROIN STRETCH



MODIFIED HURDLER

The following stretching exercises are supplemental stretches that may be incorporated as part of a physical fitness training session:

SHOULDER and NECK STRETCH

STANDING ITB STRETCH



HIP AND BACK STRETCH



LOWER BACK STRETCH

HAMSTRING OPTION





Directions for hamstring stretch: While lying on your back, pick up one leg and hold it behind your thigh while leaving the other on the deck. Straighten the leg you are holding by contracting (squeezing) the quadriceps muscles. Repeat the movement with your opposite leg.

ABDOMINAL STRETCH (COBRA)



The following commands are used with the conditioning exercises:

1. Cadence from Series GySgt
2. Repetitions “sound off” from recruits
3. Follow order on card
4. Perform in a “controlled” manner
5. Five, four-count repetitions
6. Exhale on positive movement
7. Last rep, recruits shout “Marine Corps”

Conditioning Exercises

The seven conditioning exercises include side straddle hop, crunches, push-ups, elbow-knee crunches, diamond push-ups, front lunges, and side straddle hop.

The following graphics provide a model for you to follow in performing each of the stretching exercises:



SIDE STRADDLE HOPS

U.S. MARINE CORPS. JROTC
Category 3 – Personal Growth and Responsibility
Skill 1 – Physical Fitness



CRUNCHES



PUSH-UPS

ELBOW TO KNEE CRUNCHES



DIAMOND PUSH-UPS





FRONT LUNGES

Conclusion

Physical fitness will make you feel good about yourself, ensure a healthy lifestyle, and guarantee your ability to do any task you set or others set for you. To attain your optimum level of physical fitness, you must know which exercises to perform on a regular basis, understand what is meant by physical fitness as a whole. You need to know the components of physical fitness: strength, endurance, agility, and coordination. Finally, you also need to understand the stages of physical fitness and the principles of conditioning. Get out there and get fit! Start today! ❖

The National Youth Physical Fitness Program

PURPOSE

Some people consider exercise a chore, while others think it is fun – and then there are those who avoid it altogether! With the right outlook, however, everyone can find an exercise program they enjoy. More and more people are finding ways to keep fit, from walking to joining fitness clubs, because people are recognizing the importance of exercise to physical and mental health.

Although the fitness craze has hit many Americans, it has not reached most of America's youth. This is unfortunate because not only is exercise good for you, it can also be fun. You can form friendships with people you meet while exercising on the track or basketball court, working out at the gym or swimming laps at the pool. You will feel better about yourself, improve your resistance to disease, and relieve the stress of work or school. Basically, being fit improves your overall health – both physically and mentally.

*How can you determine if you are physically fit? One way to do so is to take a **physical fitness** test at least twice a year. The National Youth Physical Fitness Program is a recognized test for assessing your level of fitness. This chapter includes the five basic exercises that make up that test, the appropriate positions and movements for each exercise, how to perform each, and the scoring chart for each exercise.*

Introduction

The National Youth Physical Fitness Program (YPF) is designed to help young people gain both self-respect and self-esteem. The YPF program encompasses students from kindergarten and elementary school, through junior and senior high school to college. The United States Marine Youth Foundation, Inc., a non-profit corporation, has funded and administered this fitness program to all schools and youth groups in America for more than 35 years.

Students are tested in five basic exercises and are awarded scores that indicate their general physical fitness. Among its many objectives, the YPF program provides students the opportunity, encouragement, and guidance to participate in competitive physical activities. This program also provides young people with realistic challenges and inspires in youth a lifelong respect for a healthy body.

The YPF program recommends that students participate in a doctor-approved aerobic activity at least three times each week for a minimum of 20 minutes each time to improve cardiovascular fitness and performance of the five exercises. The YPF program recommends that students be tested three times during the school year. The first testing should take place near the beginning of the school year to assess each person's level of fitness. The second testing should be done near the middle of the school year to evaluate each student's progress. The final testing should be conducted near the end of the school year, and these scores can then be used to determine which students qualify for a Certificate of Athletic Accomplishment. This schedule represents recommendations from the United States Marine Youth Foundation. Your instructor

will determine how best to implement this program for you and your school.

Five Exercises

These are the five exercises that make up the physical fitness test and what each one is designed to improve in terms of physical fitness:

1. Sit-ups: strengthens abdominal muscles;
2. Push-ups: develops upper body strength;
3. Pull-ups: develops upper body **strength**;
4. Standing long jump: increases leg strength;
5. Shuttle run: increases **agility, speed** and **endurance**.

Sit-Ups

You need to take care in performing sit-ups so that you do not injure yourself. Sit-ups should be performed on mats such as those used for tumbling or wrestling. For the physical fitness test, you have a time limit of two minutes to perform as many sit-ups as you can. It is important to note that you may rest in either the up or down position as long as you maintain the correct body position while resting. There are three positions in which you can perform the sit-ups. Your instructor will determine which of these positions is most appropriate for you.

Full Exercise:



- Position: Lie on your back with your legs bent and your feet on the mat. Your thighs form a 45-degree angle with the ground. Place your hands behind your head with your fingers interlocked and touching the mat. A partner or an official counter holds your feet in place.
- Execution: Sit up, bending forward until your forehead is directly above or in front of your knees. Be certain you keep your elbows outside of your knees. Now return to the starting position, making sure that your knuckles or the backs of your hands touch the mat before you begin the next repetition.

Modification #1:



- Position: Lie on your back with your legs bent, your shoulders flat on the mat, your head raised, and your feet on the mat. Fold your hands across your chest. Again, as in the full exercise, your partner or an official counter holds your feet in place.
- Execution: Sit up, bending forward until your forehead is directly in front of your knees. Your arms remain folded across your chest. Return to the starting position, making sure that your shoulders touch the mat before you begin the next repetition.

Modification #2:



- Position: Sit on the mat with your legs bent and your feet flat on the mat. Your thighs form a 45-degree angle with the ground. Rest your weight on your elbows and your forearms, and place your thumbs on your groin. Again, as in the full exercise, your partner or an official counter holds your feet in place.
- Execution: Sit up, bending forward until your forehead is directly in front of your knees. Return to the starting position, making sure that your elbows and forearms are flat on the mat before you begin the next repetition.

The following chart provides the age, number of repetitions, and points awarded for the number of sit-ups completed within the two-minute time limit.

Sit-Ups

	Age	Age	Age	Age
Reps	14	15	16	17+
6	1	-	-	-
9	4	2	-	-
12	7	5	3	2
15	10	8	6	5
18	13	11	9	8
21	16	14	12	11
24	19	17	15	14
27	22	21	18	17
30	25	23	21	20

33	28	26	24	23
36	31	29	27	26
39	34	32	30	29
42	37	35	33	32
45	40	38	36	35
48	43	41	39	38
54	49	47	45	44
60	55	53	51	50
66	61	59	57	56
72	67	65	63	62
75	70	68	66	65
80	75	74	71	70
86	82	80	77	76
91	92	88	84	82
95	100	96	92	90
100	100	100	100	100

Push-Ups

Everyone seems to groan when push-ups are mentioned, but if you perform them correctly and gradually work up to an acceptable number of repetitions, you will find that they are well worth doing. Push-ups, done correctly, develop your upper body strength. There are three positions in which you can perform the push-ups. Your instructor will determine which of these positions is most appropriate for you.

Push-ups should be performed on mats such as those used for tumbling or wrestling. For the physical fitness test, you have a time limit of two minutes to perform as many push-ups as you can. It is important to note that no rest pause is permitted when you are performing push-ups. The exercise must be completed in a continuous motion.

Full Exercise:

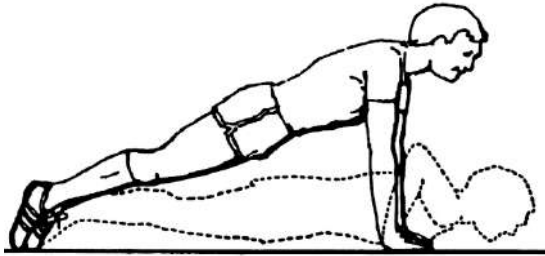

- **Position:** Place your hands, palms down, on the mat with your thumbs directly under your shoulders. Hold your body in a straight line from your shoulders to your feet with no part of your body touching the mat. Lock your elbows with your arms forming a straight line from your shoulders to your wrists. Your feet may be no more than one foot apart. The official counter lies face down on the mat opposite you, placing his or her hand palm down under your chest.
- **Execution:** Lower your body by bending your elbows and bringing your torso downward until your chest touches the back of the counter's hand. Your body must maintain a straight line from your shoulders to your feet. You then return to the starting position, always maintaining your body in a straight line. Your elbows lock straight before you begin your next repetition.

Modification 1:



- **Position:** Extend your arms to their full length with your hands and fingers pointing forward on the ground just under and slightly outside of your shoulders. Bend your knees at right angles to your body. Your body should be extended in a straight line. Your hands and knees support your weight. The counter lies face down on the mat opposite you, placing his or her hand down under your chest.
- **Execution:** You must keep your body tense and straight, bend your elbows and touch your chest to the back of the counter's hand. Your feet remain in the air and your knees remain at right angles to your body. Return by pushing your body back to its original position so that our elbows lock straight before you begin your next repetition.

Modification 2:

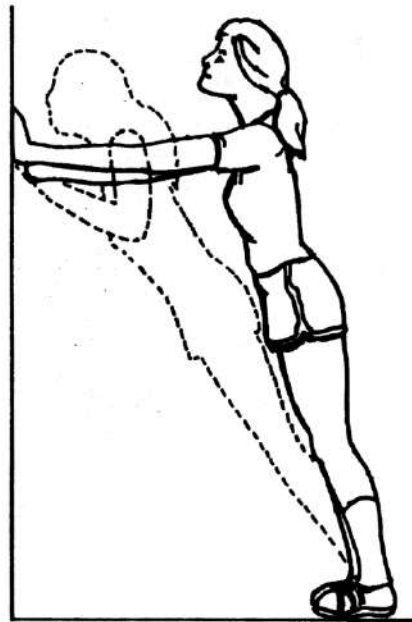

U.S. MARINE CORPS. JROTC
Category 3 – Personal Growth and Responsibility
Skill 1 – Physical Fitness

- Position: Stand with your feet together one arm's length from the wall. Place your hands flat on the wall approximately one body width apart, keeping your arms straight.
- Execution: Bending your elbows, lean your body into the wall until your forehead touches the wall. Push your body back until your arms are straight. Repeat the exercise as many times as possible.

The following chart provides the age, number of repetitions and points awarded for the number of push-ups completed within the two-minute time limit.

Push-Ups

	Age	Age	Age	Age
Reps	14	15	16	17+
2	2	2	2	2
4	4	4	4	4
6	6	6	6	6
8	8	8	8	8
10	12	10	10	10
12	16	12	12	12
14	20	14	14	14
16	24	16	16	16
18	28	20	20	18
20	32	24	24	20
22	36	28	28	24
24	40	32	32	28
26	44	36	36	32
28	48	40	40	36
30	50	44	44	40
32	56	52	48	44
35	64	58	54	50
38	76	68	60	56
40	84	76	68	60
42	92	84	76	68

44	100	92	84	76
46	"	100	92	84
48	"	"	100	92
50	"	"	"	100
54	"	"	"	"
58	"	"	"	"
60	"	"	"	"

Pull-Ups

Like push-ups, pull-ups develop your upper body strength. And like push-up and sit-ups, there are three positions in which you can perform pull-ups. Your instructor will determine which of these positions is most appropriate for you! You will need pull-up bars, approximately 1 ½" outside diameter. There is no time limit for this event and you are permitted to rest, but in the down position only.

Full Exercise:



- Position: Hang from the bar with your palms away from your body, your thumbs curled under and around the bar. Your arms and

legs must be completely extended with your feet off the floor. You may cross your ankles to keep your legs together.

- Execution: Pull your body straight up, placing your chin over the bar. Now, return to the starting position with your arms fully extended.

Modification 1:

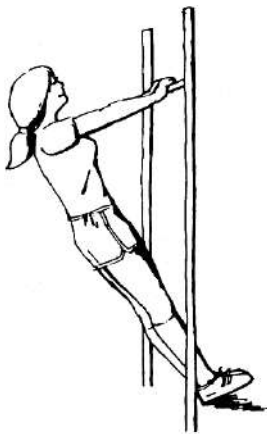

- Position: Adjust the height of the bar to the level of our chest. Grasp the bar with your palms facing out. Extend your legs under the bar, keeping your body and your knees straight. Be sure your heels are on the floor. Fully extend your arms so they form a 90-degree angle with the line of your body. A partner braces your heels to prevent you from slipping.
- Execution: Pull your body up with your arms until your chest touches the bar. Lower your body until your elbows are fully extended. Repeat the exercise as many times as you can.

Modification 2: Flexed Arm Hang

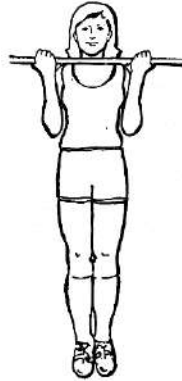

- Position: Grasp the bar with your palms facing your body. Your partner lifts you into place until your chest touches the bar.
- Execution: Hold your body straight with your chin above the bar as long as possible. When your chin is no longer above the bar, time is called.

The following chart provides the age, number of repetitions and points awarded for the number of pull-ups completed.

Pull-Ups

	Age	Age	Age	Age
Reps	14	15	16	17+
1	6	5	5	5
2	12	10	10	10
3	18	15	15	15
4	24	20	20	20
5	30	25	25	25
6	36	30	30	30
7	42	35	35	35
8	48	40	40	40
9	54	45	45	45
10	60	50	50	50
11	66	55	55	55
12	72	60	60	60
13	80	65	65	65
14	86	70	70	70

U.S. MARINE CORPS. JROTC
Category 3 – Personal Growth and Responsibility
Skill 1 – Physical Fitness

15	92	75	75	75
17	100	90	85	85
20	100	100	100	100

The following chart provides the age, number of repetitions and points awarded for the number of Flexed Arm Hangs completed.

Flexed Arm Hang										
Seconds	Points		Seconds	Points		Seconds	Points		Seconds	Points
70	100		52	64		34	34		17	17
69	98		51	62		33	33		16	16
68	96		50	60		32	32		15	15
67	94		49	58		31	31		14	14
66	92		48	56		30	30		13	13
65	90		47	54		29	29		12	12
64	88		46	52		28	28		11	11
63	86		45	51		27	27		10	10
62	84		44	48		26	26		9	9
61	82		43	46		25	35		8	8
60	80		42	44		24	24		7	7
59	78		41	42		23	23		6	6
58	76		40	40		22	22		5	5
57	74		39	39		21	21		4	4
56	72		38	38		20	20		3	3
55	70		37	37		19	19		2	2
54	68		36	36		18	18		1	1
53	66		35	35						

Standing Long Jump

The standing long jump should be performed on any surface where you can jump into a soft area. Your take-off line must be clearly marked and a tape measure is required to measure the distance you jump. For the physical fitness test, you have a time limit of three minutes to complete 3 jumps.

Only the best of three jumps will be recorded for scoring purposes. You must complete your three jumps within three minutes. Your jump is measured from the take-off line to the nearest point of contact on your landing. Stepping over the line and continuing the jump is considered a foul and counts as an attempt. Your foul jumps are not measured. Falling or stepping backward after your landing results in a measurement to that point of contact rather than where your feet first touched.

- **Position:** To complete a standing long jump, stand with your feet comfortably apart, your toes just behind an established take-off line. Flex your knees and then swing your arms forward and backward to build momentum for your jump.
- **Execution:** Jump forward as far as possible. Your landing can be on one or both feet.

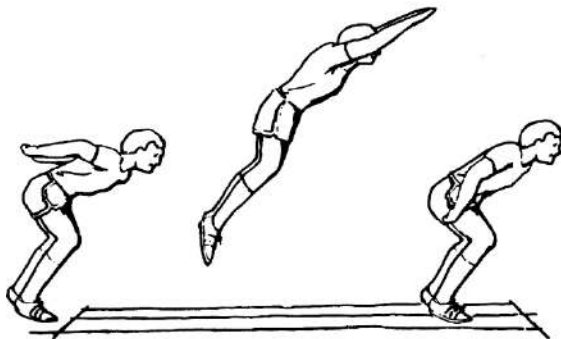

The following chart provides the age, the measure of feet and inches achieved in performing a long jump, and the points awarded each measurement.

		Age	Age	Age	Age
Ft.	In.	14	15	16	17+
4'	8"	-	-	-	-
4'	10"	2	-		
5'	1"	6	-		
5'	2"	10	4		
5'	4"	14	8	2	
5'	6"	18	12	6	
5'	8"	22	16	10	4
5'	10"	26	20	14	8
6'	0"	30	24	18	12
6'	2"	36	28	22	16
6'	4"	42	33	26	20
6'	6"	48	39	30	24
6'	8"	54	45	36	28
6'	10"	60	51	42	33
7'	0"	68	57	48	39
7'	2"	76	64	54	45
7'	5"	88	76	64	54
7'	8"	100	88	76	64
7'	11"	"	100	88	76
8'	2"	"	"	100	88
8'	5"	"	"	"	100
8'	8"	"	"	"	"
9'	0"	"	"	"	"
9'	4"	"	"	"	"
9'	8"	"	"	"	"
9'	10"	"	"	"	"

Shuttle Run

The shuttle run is 300 yards in length. Placing two pylons 60 yards apart sets up a "course," which must be level. To perform this event, you need stop watches to time the event

U.S. MARINE CORPS. JROTC
Category 3 – Personal Growth and Responsibility
Skill 1 – Physical Fitness

and starting pistols to properly start the shuttle run.

You must run the event continuously without stopping. If you fail to complete the run, you receive no points. If you knock over a pylon while making a turn, you must return it to the upright position before completing your event. If adequate equipment and timers are available, more than one person may run the event at a time.

- **Position:** You may use either a standing distance type start or a crouched **sprinters** start. No part of your body may extend over the starting line and no device such as starting blocks or depressions may be used to assist you.
- **Execution:** You must run the 60-yard distance five times, making a complete turn around each marker. On your fifth leg of the run, your total elapsed time is clocked and recorded as you cross past the pylon.

The following chart provides the age, the elapsed time run in the shuttle run event, and the points awarded each elapsed time.

		Age	Age	Age	Age
Min.	Sec.	14	15	16	17+
1	40	-	-	-	-
1	38	-	-	-	-
1	36	2	-	-	-
1	34	4	-	-	-
1	32	6	2	-	-
1	30	8	4	2	
1	28	10	6	4	2
1	26	12	8	6	4
1	24	14	10	8	6
1	22	18	12	10	8
1	20	22	14	12	10
1	18	26	18	14	12
1	16	30	22	18	14

1	14	34	26	22	18
1	12	38	30	26	22
1	10	44	34	30	26
1	08	50	38	34	30
1	06	56	44	38	34
1	04	62	50	44	38
1	02	68	56	50	44
1	00	76	62	56	50
	58	84	68	62	56
	56	92	76	68	62
	54	100	84	76	68
	52	"	92	84	76
	50	"	100	92	84
	48	"	"	100	92
	46	"	"	"	100
	44	"	"	"	"

How to Earn a Certificate of Athletic Accomplishment

Certificates of Athletic Accomplishment are awarded yearly by the United States Marines Youth Foundation, Inc. A student must earn a composite score of 250 points or more (for both boys and girls) to be considered eligible to receive a Certificate of Athletic Accomplishment. Composite scores are determined by adding up the scores from all five exercises. Any student who participates throughout the school year, but does not reach this score, is eligible to receive a Certificate of Participation. Your instructor can order certificates when the final testing is completed in March or April by mail or telephone at the following address:

United States Marines Youth Foundation, Inc.
 8626 Lee Hwy Suite #203
 Fairfax, VA 22031
 Phone: (703) 207-9690
 Fax: (703) 207-9692
 Toll Free: 888-876-2348
 Email: ypf@mcleague.org

Certificates are not awarded according to age or grade level. The first time a student passes the test, he or she is awarded the First Certificate of Athletic Accomplishment. The second time that same student passes the test, he or she is awarded the Second Certificate of Athletic Accomplishment. Only one certificate per student per year is awarded.

Conclusion

How well you perform on these five basic exercises indicates your general physical fitness. This program presents you with realistic challenges and hopefully inspires you to maintain a lifelong respect for a healthy body. Recognize the importance of exercise to your physical and mental health, and strive to achieve your best scores each time you take the Youth Physical Fitness test. ❖

Personal Hygiene

PURPOSE

To get the most out of anything that you own – a car, CD player, your golden retriever – it is important to take good care of it. The same goes for your body. To be your best, take the best care of yourself. Eat right, exercise on a regular basis, and above all (especially if you want to develop a good self-image and make a good impression on those you meet), practice personal cleanliness.

Begin each day with a bath or shower, shampoo your hair regularly, brush and floss your teeth daily, and see the dentist twice a year. Attend to any cuts, sores, or abrasions immediately to prevent infection. See your doctor if the problem worsens. Clean clothes every day are a must. At home, work, and school, wash your hands and face before mealtime to prevent contamination of your food.

These are all good habits we know, but do we know why we need to practice good personal hygiene and how to do it most effectively? Read on...

Introduction

Hygiene is the study and observance of health rules. Rules such as hand washing, bathing, and the avoidance of eating uncooked meat have been practiced since ancient times and are critical to the maintenance of personal and public health.

Hygiene begins the moment we get up. As soon as we begin our day, we begin to take care of our bodies. We use water, soap, and a washcloth to wash our faces. If necessary, we shampoo our hair, and shave. We brush our teeth, hopefully floss, and use mouthwash. We use a deodorant or antiperspirant. We may use talcum powder, or perhaps anti-fungal foot powder. We put on clean clothes – especially clean socks. We wash our hands, not just at the beginning of our day, but ideally 10 or 15 times a day.

We may or may not do some or all of these things daily. Why are these practices so important to our physical and emotional well-being? We can start to answer that question by looking first at our skin.

Your Skin

Skin is the largest organ in the body, both by weight and surface area. In adults, the weight of your skin accounts for about 16% of your total body weight. Normally, the skin separates you and your critical organs, blood vessels, nerves, etc. from the external environment. However, skin diseases and infections can compromise that barrier. Infections and diseases also affect your nails and hair.

The skin serves many purposes:

- It serves as a barrier to the environment, and some glands (sebaceous).
- It acts as a channel for communication to the outside world.
- It protects us from water loss, friction wounds, and impact wounds.

- It uses specialized pigment cells to protect us from ultraviolet rays of the sun.
- It produces vitamin D in the epidermal layer, when it is exposed to the sun's rays.
- It helps regulate body temperature through sweat glands.
- It helps regulate metabolism.
- It has aesthetic and beauty qualities.

General Personal Hygiene

All areas of the skin and mucous membranes such as the mouth and nose are colonized with **microorganisms**. Although not harmful under “normal” conditions to the carrier, microorganisms can produce infection if transferred to other areas of the body, e.g., the urinary tract, or if transferred to another person. Regular bathing or showering and good general personal hygiene can reduce the risks of self- as well as **cross-infection**.

Bathing or Showering

Bathing or showering is commonly viewed in our society as a source of relaxation or rejuvenation. There are all kinds and varieties of products available to us to make bathing a great pleasure -- bath oils, gels, salts, cleansing liquids, and bubble baths. Many of these come in a wide variety of scents. Many people also choose bathtubs that circulate or bubble the water, providing therapeutic as well as emotional benefits. However, the main reasons for bathing or showering are to remove dirt, dead skin cells, microorganisms, and body odor. In the U.S., most people bathe daily, however this is not the case in certain cultures.

When to Bathe?

This question particularly interests young women and girls, but it is just as important for young men and boys. It would be better to bathe every day. There are a number of good reasons for bathing. Cold water is useful for improving blood circulation in our organs, and warm water encourages the pores in the skin to open.

Is it best to bathe in a tub or under a shower? This is probably a personal preference, but you should consider that bathing under a shower is probably the best choice because flowing water not only assists us in the process of bathing, but also offers the benefits to our blood pressure, our nerves, and seems to remove some of the feeling of tiredness.

Soap

Soap making is an ancient art. Some recipes date back to some 6,000 years ago. Early soaps were a luxury item and although they were adequate cleansers and fully **biodegradable**, they were not very skin-friendly. Today's soaps are much easier on your skin.

Regular soap is generally fine for everyday bathing. Bathing with an antimicrobial soap decreases the rate of skin infections. It is a good idea to use it when infections are likely to occur. Washing your hands with an antibacterial soap may decrease the transmission of infectious agents. Antibacterial soap is a good choice for use before and after eating, using the bathroom, or doing dirty work such as gardening. If you work in food service, you will be required to use an antibacterial soap on the job.

Mildness, biodegradability, low toxicity, cleansing ability, emulsification, moisturization, skin appearance, and feel and lubrication are all important aspects of how a soap performs.

Sweating

Your body constantly produces heat because of the chemical reactions necessary to metabolism. Perspiration or sweating is the body's way to deal with the heat generated from exercise or heat in the environment. As water evaporates on the surface of the skin, heat is lost to the environment. Body water is routinely lost via perspiration and by the humidification of the air that enters and leaves the lungs.

The average adult loses about 0.7 liters of sweat per day but sweat losses can be as much as 2.5 liters per hour, for example, after exercising. Water must be replaced to maintain the necessary fluid balance in your body. Water imbalances of only 1-2% can lead to illness or even death. The general guideline for the amount of water you should drink each day is eight glasses. People who engage in strenuous exercise or work outside in hot climates; have a fever, diarrhea, excessive urine losses, or are vomiting; those on high protein diets or taking diuretics, all have increased fluid needs. These people need to drink more than eight glasses a day to compensate for this loss of fluid.

Body Odor

Body odor is commonly caused by a combination of perspiration and bacteria. Armpits, groin, and feet are the main sites from which bad body odor originates. Eating certain foods can also cause body odor. Spices such as garlic, cumin, and curry tend to linger in excretions and secretions of the body after eating these spices.

The skin produces an oily substance called **sebum** that helps protect the skin from the environment. This oil traps dirt, dust, dead cells, and the odor-causing substances created by the

action of bacteria on perspiration. Soap helps dissolve and remove this oily debris from the skin, which can then be washed away.

Since it is necessary to remove the protective sebum during bathing to remove the dirt, dust and dead skin cells, some people complain of dry skin, irritation, or itching after a bath. Using creams or lotions can help add back moisture to the skin after a bath or shower.

Deodorants and Antiperspirants

A deodorant is an agent that covers or absorbs bad odors without limiting perspiration. Antiperspirants are substances that inhibit perspiration either by reducing pore size or by clogging pores to retard perspiration. Aluminum chlorohydrate (or derivatives of this compound) is the most common compound used in antiperspirants and deodorants. Cyclodextrins, baking soda, or talc may be included in an antiperspirant or a deodorant to absorb moisture and odor.



Be aware, however, that deodorants and antiperspirants may contain antibiotics and preservatives that can cause skin irritation. Avoid applying deodorants and antiperspirants to broken or irritated skin.

Personal Hygiene Materials

Materials such as bath sponges, nail brushes, toothbrushes, and towels used for personal hygiene can become contaminated and can act as spreaders of infection if not correctly maintained. You should follow these suggestions:

- Washcloths, bath sponges, nail brushes, and toothbrushes should be thoroughly rinsed under running water after use and then dried as rapidly as possible.
- If washcloths or other items are left in a damp condition, contamination will rapidly multiply.
- Face cloths and sponges should be regularly laundered.

Hand Hygiene

As every doctor, nurse, and health-care worker will tell you, a great deal of infection and sickness can be prevented by not spreading germs in the first place. Because it is so easy to transmit infection via your hands, it is extremely important to be aware of the fact that *any* item, surface, or object (including human skin) touched by the hands after contact with a **contaminated** source will be contaminated with microorganisms from that source.

The major contamination sources include such things as raw food, pets, soiled diapers, contaminated surfaces, and reservoir sites such as toilets, sneezing, coughing, and transfer of nasal secretions to the hands. Thoroughly washing your hands with soap and running water can effectively

remove this microbial contamination picked up onto the hands by contact with a contaminated source.

Hands should be washed:

- Before handling food.
- Before eating.
- After using the toilet.
- After handling pets, pet cages, pet feeding utensils, or other pet objects.
- After coming into contact with body fluids, such as nasal secretions, saliva, vomit, etc., or after changing a baby's diapers.
- Whenever hands are visibly dirty.
- Before giving or applying medication to yourself or another person.
- Before applying contact lenses.

Most experts say effective hand washing should last 10 to 15 seconds. If that sounds short, count the seconds you spend washing and you will see that even the 10-second minimum feels like an eternity. It takes time to clean all the nooks and crannies, including the palms, spaces between the fingers, backs of the hands, and especially in and around the fingernails.

Instructions for Effective Hand Washing

The following instructions provide an effective method for hand washing.

- Use warm running water and preferably a liquid soap.
- Apply a small quantity of soap to your hands.
- Rub your hands together vigorously and be sure you apply soap and water to all surfaces of your hands.

- Be sure to scrub between your fingers, under your fingernails, and around the tops and palms of your hands.
- Rinse your hands under running water.
- Dry your hands with a clean towel.
- Turn the tap off. If possible, do not touch the tap directly with your washed hands to avoid possible recontamination.

Suggested Sequence for Hand Washing

- Palm to palm;
- With the palm over the back of the hand;
- Palm to palm with fingers interlaced;
- The back of the fingers with the opposing palm;
- Rotational rubbing of the thumbs in the palm of the hand;
- Rotational rubbing of fingers in the palm.

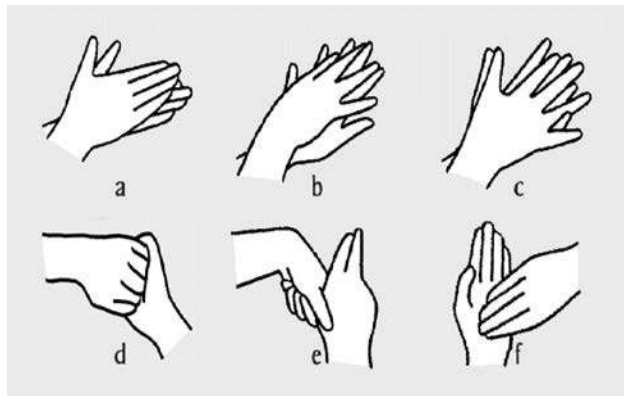

Fingernails and Toenails

Nails are important and useful parts of your body. They provide protection and support to the ends of your fingers and toes, heighten your

sense of touch, and make it easier for you to handle small objects. Nails also work great for taking care of that itch!

Cutting and cleaning nails properly can help avoid some nail problems. Be gentle when you clean underneath your nails in order to avoid breaking the protective seal underneath the nail plate called the hyponychium. Keep your nails smooth and properly trimmed. Trim your fingernails weekly. Your toenails grow slower; they do not need to be trimmed as often. Typically, you should trim your toenails about once a month.

Use sharp manicure scissors or clippers to trim nails, and an emery board to smooth the edges. Generally, nails are softer and easier to trim after bathing; this is a good time to do your nail care. Trim your fingernails with a slightly rounded edge. Your toenails should be trimmed straight across. Avoid cutting your toenails too short to reduce the chance of developing ingrown toenails.

Nail polish may coat and protect your nails slightly, but try to use nail care products only on occasion. Especially avoid using nail polish remover, which can weaken and dry your nails. Using nail strengtheners can discolor or break your nails and artificial nails may produce reactions under the nail. There is no scientific evidence that gelatin, calcium, or nutritional supplements will improve your nails if your general diet is good.

Do not trim your cuticles or use cuticle removers. Cuticle removers are corrosive and may damage the skin around the nail. Trimming the cuticle results in damage to the skin at the base of the nail and allows an entry point for fungi -- and bacteria -- that can result in infection.

Nails that are brittle and crack or split easily can result from excessive wetting and drying of the nails. To avoid this, use a moisturizer on

your hands, and especially the nails themselves, frequently. Nail polish can also be good for brittle nails since it protects them from water exposure. However, nail polish remover can be very harsh on the nails since it dries them out. It is a good idea not to remove and reapply nail polish frequently.

Fingernail and toenail damage or deformities can cause some people pain and embarrassment. Some symptoms may also be a sign of systemic diseases such as anemia and long-standing infections. Trouble signs to look for are nails that are discolored, thickened or become detached from the skin. Being aware of changes in your nails and seeking advice from your doctor can help determine how to correct the situation. If your fingernails or toenails look different, talk to your primary care doctor or a dermatologist.

Shampoos

Shampoos are designed to clean your hair and your scalp. They contain surfactants, or detergents, that lift dirt and oil off the hair so they can be rinsed away. Most shampoos clean your hair very well. Where they differ is how your hair feels afterward. Some surfactants are stronger than others, and might strip away too much of your natural oils. Most shampoos also contain a bit of conditioner, which can make a difference in how your hair feels afterward.



Key Features of Shampoo

Deciding which shampoo is right for you is probably a matter of trial and error. Most shampoos today fall into one of a few categories; figure out which category suits your head, then try a few different products.

Clarifying shampoos contain heavy-duty surfactants. Some are too strong for daily use. They are usually intended to be used once or twice a week to deep clean hair and remove the “gunky” build-up of conditioners, sprays, and gels.

Bodybuilding or volumizing shampoos promise to add body to limp hair. They often contain proteins that bond to hair and “pump it up.”

Moisturizing shampoos are the best choice for dry, flyaway hair. They can cut down on static, make split ends look better (by gluing them together with proteins), and add moisture to your hair to keep it from getting too dry.

Revitalizing or replenishing shampoos are made for color-treated, permed, and damaged hair. Some shampoos can be too harsh on treated hair; so revitalizing shampoos often use a gentler cleanser, and have ingredients that protect color from fading or help to repair split ends and other damage.

Dandruff shampoos contain medication that loosens and rinses away those annoying flakes. Some anti-dandruff shampoos need a few minutes so be sure to leave it on long enough to do its job.

Two-in-one shampoos with conditioner save time in the shower by giving you both products in one bottle. Unfortunately, these products may leave your hair feeling less conditioned than if you had used a separate conditioner.

Swimmer's shampoos remove chlorine and other minerals that can build up on your hair in the pool and cause damage, discoloration, and even a funny odor.

Conditioners

Conditioners use different ingredients to make your hair more manageable. Most contain compounds that reduce the static charge on your hair. Other ingredients, such as balsam and silicones, coat the hair to provide a protective coating and smooth out the frayed cuticles. Waxes can provide increased volume, and oils provide extra sheen.

Shaving Cream

Shaving cream softens body hair and skin, reduces razor friction on the skin during shaving, and helps prevent razor cuts and irritation. Whatever your skin type or shaving style, there is a shaving cream for you.

How to Choose a Shaving Cream

Most shaving creams include a mixture of ingredients known as moisturizers and protectants. These ingredients work by attracting and keeping moisture in your skin, which makes for a softer, smoother shave. Aloe, an ingredient often found in shaving creams for sensitive skin, is a moisturizer. Stearic acid, another ingredient common in shaving creams, is a softening protectant.

Finding the right shaving cream is a matter of trial and error and personal preference. Aside from men's and women's shaving creams, these are among your options:

- Soap-based shaving creams expelled from aerosol cans spout out rich, thick foam for a

clean, close, comfortable shave. Some foam shaving creams use moisturizers to soften the hair further.

- Gel emerges from the can in a liquid form, but turns into lather once you rub it onto your skin. Thicker and richer than shaving cream, gels offer increased protection against nicks and cuts with a blend of skin conditioners, protectants, and lubricants.
- Brushless shaving creams resemble shaving cream in a toothpaste tube. They are called brushless because you can work them into a lather using your hands as opposed to a shaving brush.
- Shaving powder is actually misnamed because it removes hair without shaving. The powders are depilatories that dissolve hairs just below the skin's surface, allowing them to be wiped away. Shaving powder is recommended for people who suffer from razor bumps caused by traditional shaving methods.

How to Use Shaving Cream

- Before you begin to shave, wash the area with hot water and enough soap to get your skin clean. Then use a warm washcloth to remove excess oil and soften up the hair.
- Use a clean, sharp razor and a dollop of shaving cream about the size of a cherry tomato.
- Shave the easiest areas first. The longer the tough-hair areas have to absorb water, the softer the hair will be when it is time to shave.
- Shave in the direction the hair grows. Take your time and shave carefully over sensitive areas. For a super-close shave, carefully shave against the grain.

- Applying an aftershave can soothe sensitive areas. You may also want to use a moisturizer between shaves.

Oral Hygiene

Oral hygiene is the best means of preventing cavities, **gingivitis**, **periodontitis**, and other dental disorders. It also helps prevent bad breath or **halitosis**. Oral hygiene is necessary to keep your teeth and mouth in good condition. Healthy teeth have fewer cavities, are clean and have minimal, or no **plaque** deposits. Healthy gums are pink and firm.

Oral hygiene consists of both personal and professional care.

Personal Care

Carefully brushing and flossing your teeth helps to prevent build-up of plaque and calculus or **tartar**. Brush your teeth at least twice daily and floss at least once each day. For some people, brushing and flossing may be recommended after every meal and at bedtime. Consult your dentist or dental hygienist if you need instruction or demonstration of proper brushing and flossing techniques.

Your dentist or dental hygienist may recommend fluoride containing or anti-plaque (“tartar control”) toothpastes or mouthwashes.

Dentures, retainers, and other appliances must be kept extremely clean. This includes regular brushing and may include soaking them in a cleansing solution.

Professional Care

Regular tooth cleaning by your dentist or dental hygienist is important to remove plaque that may develop even with careful brushing and flossing. Professional cleaning includes scaling and

polishing to loosen and remove deposits from your teeth that remain after normal brushing and flossing. Many dentists recommend having your teeth professionally cleaned at least every 6 to 12 months. You should have a routine examination of your teeth at least every year. Often an exam includes dental X-rays.

Good oral hygiene prevents and is vital to the treatment of many dental and oral disorders. Good oral hygiene results in healthy teeth and mouth. Usually there are no complications; however, overly vigorous or improperly performed brushing and flossing may result in injury to the gingival or gums.

Call your dentist or dental hygienist if you are unsure of how to properly brush or floss your teeth or to schedule a routine dental cleaning and exam.

Brushing Your Teeth

It is extremely important that you brush after every meal to prevent the build up of plaque. Plaque is a sticky bacterial substance that forms on your teeth. Plaque mixes with the sugars inside your mouth, forming strong acids that hasten tooth decay.

When your teeth are not properly brushed, plaque builds up on the surfaces of the teeth and irritates your gums. If this condition is left untreated, your gums will respond by pulling away from the teeth leaving pockets that contain bacteria and pus that irritate and destroy the bone that holds the teeth in place.

Eventually, the bone loss can become severe and the bones will no longer support the teeth. Tooth decay and gum disease are easily preventable by brushing, flossing, proper nutrition, and visiting your dentist once every six

months for a professional cleaning and examination.

The American Dental Association suggests these steps for home dental hygiene:

- Place the head of the toothbrush against your teeth, with the bristle tips angled against the gum line at a 45-degree angle.
- Move the brush back and forth with a short (half a tooth wide) stroke in a gentle scrubbing motion. Brush the outer surfaces of each tooth, upper and lower, keeping the bristles angled against the gum line.
- Using the same motion, brush the inside surfaces of your teeth.
- Scrub chewing surfaces of all teeth, using a light pressure and letting the bristles reach into the grooves of your teeth.
- To clean the inside of your front teeth, tilt the brush vertically and make several gentle up-and-down strokes with the “toe” (the front part) of the brush over the teeth and gum tissue of your upper and lower jaws.
- Brush your tongue to freshen your breath.

Toothbrushes

Did you know that the ancient Chinese get credit for the first toothbrush, made of hog hair bristles attached to a bamboo handle? Today, there are literally hundreds of varieties to choose from -- none with hog hair! All toothbrushes have the same purpose -- to remove plaque from the surface of your teeth, preventing tooth decay and gum disease and keeping your smile bright.

Most of us still use manual toothbrushes with nylon bristles and a plastic handle, but electric models, with brush heads that rotate several thousand times a minute, are increasing in

popularity. Whichever type of toothbrush you prefer, remember to brush at least twice daily for two to three minutes.



How to Choose a Toothbrush

The best toothbrush is the one you like best, so that you will be inclined to use it regularly. Some key features to consider as you make your choice are bristles, head size, handle shape, and whether to use a manual or an electric toothbrush.

Bristles

Bristles can range from extra-soft to soft, medium, or firm. Softer is better: Rigorous brushing with firm bristles can damage your gums. If your gums are especially sensitive, use a toothbrush with extra-soft bristles.

Most manufacturers use polished nylon bristles, which can be rounded and softened. Natural bristle brushes are also available, though most dentists do not recommend them. They tend to retain more oral bacteria than synthetic bristle toothbrushes do.

Whether your toothbrush has two, three, or four rows of bristles, most toothbrushes now feature rippled bristle lengths for deep, between-teeth cleaning. Longer outer bristles remove plaque along your gum line. Shorter inner bristles

sweep away plaque and debris, and more rows make a more efficient toothbrush.

Some “smart” toothbrushes like Oral-B have blue indicator dye on their bristles. When the dye wears off, it is time to replace your toothbrush.

Head size

Your toothbrush head should fit into your mouth easily to reach your back teeth. Luckily, there is a head size for every mouth. Compact brushes are built for teens and for women with small mouths. Full brushes suit adults with average-size to large mouths.

Handle shape

Straight brushes are the norm, but other shapes promise better flexibility and reach. A tapered shape can be easily maneuvered to reach your back molars. Angled handles can improve your reach.

Electric toothbrushes

Electric toothbrushes use small motors to rotate bristle heads thousands of times faster than is humanly possible.

Whether electric toothbrushes clean better than regular manual brushing is a subject of dispute. Consider the following:

- An electric brush is a good choice for people who have poor manual dexterity.
- Electric toothbrushes can require new replacement heads and batteries every few months.
- For effectiveness, the key is how long you brush, not how fast. If you use an electric brush, you will still need to brush for two to three minutes twice each day.

Toothpaste

Not too long ago all anyone expected from toothpaste was minty-fresh breath. These days, however, you will find all kinds of other benefits as well. Current toothpastes can help keep your mouth healthy by fighting tartar, attacking plaque, and even wiping out the bacteria that can cause gum disease.

There are literally dozens of brands to choose from. But do not feel overwhelmed; dentists say it is hard to make a wrong choice. Most toothpastes, used regularly for two minutes twice a day, get rid of plaque and mild stains and get fluoride to teeth to help fight cavities.

Here is a guide to some of the key ingredients and features available in different types of toothpastes.

Key Features of Toothpaste

Fluoride:

This is the key ingredient in toothpaste. Available in most brands since the 1960s, fluoride fights cavities by hardening the outer enamel surface of your teeth, making them less susceptible to decay. Once decay is present, however, do not count on fluoride to reverse the damage. By that time, it is too late. Some toothpastes have more fluoride than others, but experts say that the difference is insignificant in terms of effectiveness.

Plaque Removers

Plaque is the sticky film of saliva and bacteria that can cause tooth decay, if not removed. Most toothpastes are formulated with mild abrasives (silica is a common one) that do a good job at fighting plaque. To ensure that your toothpaste has plaque-fighting properties, look for

products with the seal of approval from the American Dental Association (ADA). However, to remove plaque from between teeth, you have to floss.

Tartar Control

Tartar is hardened plaque. Experts say you can help prevent tartar from forming by using tartar-control toothpastes, which feature ingredients called pyrophosphates. These work by clinging to your teeth above the gum line and absorbing the plaque that would otherwise collect on your teeth and harden. Tartar-control toothpastes do not remove existing tartar; that can only be done with a professional cleaning.

Antigingivitis

The latest innovation in toothpaste is the addition of an antimicrobial agent called Triclosan that kills the bacteria that cling to teeth and cause gingivitis, a form of gum disease. The ingredient is also used as a bacteria-fighter in lots of other products, ranging from hand soaps and lotions to children's toys and kitchen utensils.

Sensitive teeth

When gums recede, the root of the tooth, where nerve endings are found, can become exposed, causing increased sensitivity. Some toothpastes use an ingredient called potassium nitrate to seal off these nerve endings, making teeth less sensitive. Experts say you may need to use desensitizing toothpaste for several weeks to start noticing a benefit. These toothpastes do not work if your sensitivity is due to problems such as cavities or grinding teeth.

Whiteners

The effectiveness of whitening toothpastes is somewhat in question. These brands, which can cost significantly more than regular toothpastes, use a combination of

abrasives and bleaching agents to lighten or remove some stains from tooth enamel. Dentists are generally wary of this combination and worry that these ingredients may be harmful to your gums. Some manufacturers counter that dentists are trying to protect their own profits, which increasingly come from patients seeking professional bleaching. One thing is clear: no toothpaste can permanently whiten your teeth.

Baking Soda

Although mildly abrasive, baking soda has no real dental health benefits. Some consumers like the taste or the frothy bubbles produced by some baking soda toothpastes, but again these are not indicators of effectiveness. Be careful, though. Baking soda does not hurt your teeth, but it may irritate your gums.

Other Ingredients

What else is in those tubes? The rest of the ingredients in toothpaste, say experts, make brushing more pleasurable. Manufacturers add flavoring to improve taste, binding agents to give pastes and gels their consistency, and coloring. It is all designed to keep you brushing -- and smiling -- on a regular basis.

Dental Floss

Even with proper brushing, you only clean about three-fifths of the surfaces on your teeth. The areas in between teeth that you cannot reach with a toothbrush are best cleaned with floss or interdental cleaners.

Most of us do not floss daily, according to surveys, but dentists say we should. Flossing removes food particles and plaque from the crevices between teeth where decay and gum disease often first take root.

How to Choose Dental Floss

Choose a product that is easy to handle and glides between your teeth without shredding. Which floss works best for you will depend in large part on how closely packed together your teeth are. If you are not sure about the right floss for you, ask your dentist for a recommendation.

Dental Floss Types

Standard dental floss is nothing more than a string of coated nylon fiber. Dental tape or ribbon is as thin as regular floss but is flatter to provide a broader cleaning surface. Flosses and tapes come in a variety of widths—from thin to thick.

Waxed floss might be best for people with tight spaces between their teeth. It moves more easily between your teeth than unwaxed.

Some flosses are treated with flavors that range from mint to cinnamon and ingredients from baking soda to fluoride.

Woven floss is yarn-like and gentler on the gums than standard floss, making it a good choice for lapsed flossers. (You know who you are!)

How to Use Dental Floss

- Break off about 18 inches of floss and wind most of it around one of your middle fingers.
- Wind the remaining floss around the same finger of the opposite hand. This finger will take up the floss as it becomes dirty.
- Hold the floss tightly between your thumbs and forefingers. Guide it between your teeth using a gentle rubbing motion. Never snap it into the gums.
- When the floss reaches the gum line, curve it into a “C” shape against one tooth. Gently

slide it into the space between the gum and the tooth.

- Hold the floss tightly against the tooth. Gently rub the side of the tooth, moving the floss away from the gum with up-and-down motions.
- If floss cuts into your fingers or you have difficulty holding onto it, use a specially made dental floss handle.
- Brush after you floss.

Mouthwash

While you sleep, less of your cleansing saliva flows, so bacteria in your mouth -- the ones that form plaque and cause gingivitis (gum disease) -- start working overtime. That is the reason why you wake up with that yucky-smelling morning breath. Mouthwashes contain active ingredients that kill bacteria and prevent them from attaching to your teeth. As a result, your breath is fresh and clean smelling.

How to Choose a Mouthwash

Most brands are marketed as antiseptic. That is simply another way of saying that they kill germs. Besides choosing a mouthwash by its flavor (and there are plenty—from mint and cinnamon to bubble gum), look for the following:

- Fluoride rinses help fight cavities by hardening your teeth’s outer enamel surface.
- Antiplaque rinses use a variety of ingredients to loosen and detach plaque from tooth surfaces above the gum line.
- Smoker’s mouthwashes dissolve and remove stubborn tobacco tar stains from your teeth.
- Natural mouthwashes are typically alcohol- and sugar-free. Many use baking soda as a

natural abrasive to remove stains, plus pure mint oils or ginger for flavoring.

How to Use a Mouthwash

Most mouthwashes and rinses are for use after brushing. Why? Because brushing removes the ingredients in mouthwash from your teeth, reducing effectiveness. Here are some other tips:

- Swish or gargle with a mouthwash for about 30 seconds, then spit it out. Do not swallow!
- Do not eat or brush for a half-hour after using a mouthwash.
- Dental professionals recommend using a fluoride rinse only once a day. You can use a mouthwash more often.

Keep in Mind

- Most mouthwashes contain alcohol -- and some concentrated brands are up to 75 percent alcohol. Keep them out of reach of small children.
- If a child swallows mouthwash accidentally, seek professional help, or contact a Poison Control Center immediately.
- Some mouthwash ingredients (chlorhexidine and cetylpyridinium chloride) may cause teeth staining.

Athlete's Foot and the Care of Feet

Athlete's foot is a very common skin condition that affects nearly 70 percent of all adults. It occurs most often among teenagers and adult males, and it is very rare for women or children under 12 years of age to get infected.

Athlete's foot is a fungal infection of the skin of the feet and commonly occurs between the toes, but can affect the skin anywhere on the feet.

The fungus is a mold that likes to grow in a damp, warm and dark environment. You can be exposed to it in many everyday summer activities such as swimming, hiking, working in the garden, or just going barefoot.

Some people are more prone to getting athlete's foot than others, possibly because of their shoes and socks, or because they work out in public places, such as a gym or health center.

While athlete's foot affects some people differently, common symptoms may include: cracked, blistered, and peeling areas between the toes; redness and scaling on the soles of the feet; and intense itching. Sometimes, the itching can even spread to your toenails, resulting in scaling, crumbling, and possible nail loss.

If left untreated, athlete's foot will continue to worsen, so be certain to see your doctor if you suspect you may have athlete's foot. Do not ignore the problem because it will spread and get worse. There are several over-the-counter medications you can try, including creams and powders.

Your doctor may prescribe an over-the-counter antifungal cream or powder to treat your athlete's foot. Examples of antifungals include Lotrimin AF, Absorbine Jr. Antifungal Foot, and Tinactin. Apply the medication for the entire time directed, even if the symptoms subside. In severe cases, your doctor may also prescribe an antibiotic to treat the infection.

What to Look For

- Itching, scaling and redness that usually starts between the toes.
- Dryness, flaking or blisters on the toes or soles of the feet.
- Toenails that thicken and become layered or scaly and yellowish.

- An unpleasant odor in severe cases.

An Ounce of Prevention

While there are no surefire ways to prevent anyone from getting athlete's foot, you can follow some simple guidelines recommended by the American Podiatric Medical Association:

- Wash your feet every day with soap and water. Use a commercial brand of antibacterial soap found at your pharmacy or supermarket.
- Dry your feet thoroughly, especially between your toes.
- Change your socks daily. Cotton socks are best, because they will absorb moisture. Change your socks if they become damp or moist. Also, synthetic socks are another good alternative for fresh feet.
- Avoid tight shoes, especially in the summer. If possible, wear sandals in warm weather.
- Walk around barefoot at home. People who go barefoot in their house usually do not get athlete's foot because the skin of their foot is allowed to breathe.
- Use a quality foot powder every day.
- In the summertime, sprinkle an antifungal powder into your shoes a few times each week.
- Apply tea tree oil, a natural topical treatment that works like an antiseptic to help fight infection.
- Rotate your shoes. In other words, do not wear the same pair two days in a row. Let them air and dry out between wearings.
- Avoid walking barefoot in public areas, especially around swimming pools and health club showers, since the excessive moisture

may make your skin more **susceptible** to the fungus.

Once you have been clear of athlete's foot, you should consider replacing your old shoes with new ones, or at least replace the insole with a new one that can be found at any sports shoe store.

Conclusion

Positive personal hygiene is not hard to do. It requires developing some good daily personal habits and practicing them every day. Shower or bathe daily; use a deodorant or antiperspirant; shampoo/condition on a regular basis; brush/floss your teeth; be **vigilant** in washing your hands frequently; take good care of your feet, and keep them clean and dry. All of these personal hygiene practices will ensure you maintain a healthy body and positive self-image. You will look and feel terrific and others will enjoy your company! ❖

Suicide Awareness and Prevention

PURPOSE

- *Every 17 minutes another life is lost to suicide. Everyday, approximately 86 Americans take their own life and over 1,500 attempt suicide.*
- *For every two homicides in the U.S. there are three suicides.*
- *Every hour and forty-five minutes another young person commits suicide.*
- *Suicide is the second leading cause of death among college students and the third leading cause of death among youth overall, ages 15 to 24.*
- *More teenagers and young adults die from suicide than from cancer, heart disease, AIDS, birth defects, stroke, pneumonia and influenza, and chronic lung disease combined.*
- *Fifty-three percent of young people who commit suicide abuse substances.*
- *Four times as many men as women commit suicide, but young women attempt suicide three times more frequently than young men.*

Disturbing statistics, don't you think? Are you aware of the warning signs? Do you know what causes some teens to consider suicide? Do you know what to do if someone you know talks about committing suicide? Read on to find out more...



Introduction

Being a young person today is no easy task. Young people, as well as adults, have to deal with increasingly complex decisions and pressures every day. Tragically, many young people feel they are not able to cope with the decisions and pressures they face. They often think that no one cares enough to help them, or no one is able to help them cope with their issues and concerns. Sometimes these young people become so desperate and see no way out that they take their own lives.

Suicide does not just happen to “other people.” It can happen in any family. It is a tragedy under any circumstances, but it is especially devastating for the family and friends of those individuals who commit suicide. We are often kept from being able to help due to our fear and our lack of information and understanding of the problems of depression and suicide.

Suicide does not need to happen and can often be prevented. Knowing the causes, risks, warning signs, and what to do if faced with a potential suicide, is key to suicide prevention.

Causes of Suicide

It is best to think of the cause of suicide in terms of loss. In virtually every suicide attempt, the suicidal person describes a sense of overwhelming loss from which they can see no way to recover. The greater the number of "losses" perceived and the greater the importance of those losses, the greater the chance of suicidal responses. Here are some examples:

- Loss of a loved one (death);
- Loss of a close relationship (breakup or divorce);
- Loss of financial freedom (indebtedness, bankruptcy);
- Loss of social acceptance (legal problems and judicial punishment);
- Loss of self-control (alcohol and drugs);
- Loss of job or career objectives;
- Loss of health.

The sense of overwhelming loss produces strong emotions and feelings, such as helplessness, isolation, depression, hopelessness, despair, and worthlessness.

Combining a sense of overwhelming loss and these type of emotions can often lead even the most "normal" person to seriously consider suicide. We know that most people, but not all, who get in distress and have suicidal thoughts do not really want to die – they are in emotional pain. They feel trapped and want relief from what they see as unsolvable problems. Suicide becomes an alternative they begin to consider. Most people, but not all, are **symptomatic** in some way and communicate their distress.

Risk Factors

Learning about risk factors can help to increase your awareness of who might be at greater risk for attempting suicide. Findings from recent research have shown that most youth suicides are the result of an interaction between biological, psychological, socio-cultural, and family factors. A suicidal person can be seen as the result of an interaction between personal and family factors, his/her current emotional state, and a recent significant life event. This combination of factors can lead to an **intolerable** mental anguish in the young person. The “ingredients” for an attempted or completed suicide vary from individual to individual. There are, however, common risk factors that we know about.



Background

- Lack of roots.
- Role model for suicide in a family member or close friend.
- Disruptive and unsupportive family background.
- Past history of previous suicide attempt.

Changes in Health.

- Onset of major mental illness (e.g., depression).
- Onset of devastating physical illness (e.g., cancer, AIDS).

Personality Traits and Behavior.

- **Impulsiveness** and immaturity.
- Past history of poor or inappropriate coping skills.
- Psychiatric disorders such as schizophrenia, anorexia nervosa, and major depression.
- Desire for revenge.
- Use of alcohol or other drugs, with resultant lack of **inhibition**.
- Perfectionists and over-achievers who have high expectations for themselves.

Environmental Stresses.

- Loss of a close personal relationship or other interpersonal problem.
- “Anniversary phenomenon” (of past losses or major life events)
- Worry about school or job performance.
- Fear of abandonment, of being alone.
- Disgrace.
- Fear of loss of self-control and independence.
- Fatigue or overwork.

No cause-and-effect relationship between alcohol and/or other drugs and suicide has been established, according to the National Clearinghouse for Alcohol and Drug Information, but use of alcohol/drugs often is a contributing factor. Research indicates several possible explanations for this connection. Drinking

and/or taking drugs, may reduce inhibitions and **impair** the judgment of an individual contemplating suicide, making the act more likely. Also the use of alcohol/drugs may **aggravate** other risk factors for suicide, such as **depression** or other mental illness.

In one study of youthful suicide, drug and alcohol abuse was the most common characteristic of those who committed suicide. Seventy percent of the young people studied frequently used alcohol and/or other drugs.



Using the risk factors described above, the profile of a youth at risk of suicide can be painted as a severely depressed and drug dependent young person who is impulsive and has always struggled to cope. He or she is poorly supported by an abusive or over-involved family, and he or she has poor resources or insight to seek help. This picture, of course, does not fit the description of all youths who commit suicide.

A “forgotten” group of youths are those who have been **chronically** depressed and non-coping, but stay in the background without others noticing their distress. Their suicides may come as a surprise.

Warning Signs

The strongest risk factors for attempted suicide in youth are depression, alcohol or drug

abuse, and aggressive or disruptive behaviors. Given so many risk factors, how can we recognize someone at risk? It is important to be able to recognize warning signs of suicide so we can respond appropriately. A person who is thinking about taking his or her own life may show one or more signs. However, Christine M. Sadowski, Ph. D., a child psychologist at Mayo Clinic in Rochester, Minnesota, notes that it is important to keep in mind that the warning signs listed below are only guidelines. There is no one type of suicidal person. If you are concerned that someone is contemplating suicide – for whatever reason – arrange professional assistance for that person immediately.

Warning Signs

- Drug abuse.
- Family loss or **instability**.
- Statements about suicidal thoughts, intention, or plan (e.g., "I won't be around much longer for you to worry about," "What's the point of living?").
- Extreme mood changes, e.g., depression suddenly followed by unexplained happiness. After a period of depression, teens may become suddenly cheerful because they think that by deciding to end their lives they have "found a solution."
- Risk-taking.
- Signs of self-mutilation.
- Change in personality or behavior.
- Change in sleep habits, e.g., unable to sleep or sleeping more to escape.
- Change in appetite, e.g., loss of appetite or increase in appetite.
- Difficulties in dealing with sexual orientation.
- Frequent episodes of running away or being incarcerated.
- An unplanned pregnancy.
- Social withdrawal or isolation.
- Decreased job performance, e.g., apathy, loss of motivation, preoccupied by problems, problems sapping energy.
- Diminished self-esteem, feelings of worthlessness: "I'm simply no good."
- Poor appearance, e.g., not taking care of self.
- Abandonment of planning for the future.
- Preoccupation with death, e.g., listening to sad music, reading, writing, drawing, and or thinking about death, identifying with other people who chose suicide.
- Making final arrangements, e.g., giving things away, writing a sudden or unexplained will, writing a suicide note.
- Expressing feelings of worthlessness/hopelessness.
- Other cries for help (e.g., "Do you think anyone would really miss me if I didn't exist?" or "Can this much alcohol/drug/medicine really kill a person?").

If you suspect that someone you know is depressed, ask him or her. Be tentative and respectful, but do not worry that if you ask about suicidal thoughts you will put it in his or her mind or encourage the act. Young people are often comforted just by your concern. He or she may want more than anything to talk about what he or she is feeling. Just listening may counteract some of the person's feelings of worthlessness. And your interest and willingness to help may counteract his/her feelings of hopelessness.

Young people who have attempted suicide in the past or who talk about suicide are at greater risk for future attempts. Listen for hints like, “I’d be better off dead,” or “I won’t be a problem for you much longer.”

The warning signs and risk factors for suicide are recognizable if you know what to look for. It is important to know what you can do to help prevent a suicide if you do recognize these factors in someone you know.

Suicide

The following key words will help you remember some of the signs of suicide:

Stress

Unsupported

Isolation

Calculated (intentional)

Impulsivity

Depression

Attempted previously

Low self-esteem



What to Do if Someone Is Thinking about Suicide

You can take the following actions:

- Take threats seriously.

- Be direct. Talk openly and matter-of-factly about suicide.
- Ask about suicidal intentions. Directly discuss the subject; do not ignore it.
- Encourage the person to talk to you or to some trusted person, such as a teacher, school counselor, or clergyman.
- Be honest. If the person’s words or actions scare you, tell him or her. If you are worried or do not know what to do, say so. Do not be a cheerful phony.
- Be willing to get involved.
- Do not keep what you suspect to yourself. Break a confidence if necessary. You are not violating a confidence; you are potentially saving a life if you tell someone who may be able to help about the situation.
- Be a non-judgmental listener. Do not debate whether suicide is right or wrong, or feelings are good or bad. Provide support. Do not “lecture” on the value of life and do not expect to “make it better” right away.
- Do not challenge the individual to act on the threat.
- Offer hope that alternatives are available, but do not offer **glib** reassurances.

Get help from persons or agencies specializing in crisis intervention and suicide prevention – a community mental health agency, a private therapist or counselor, a school counselor or psychologist, a family physician, or a suicide prevention or crisis center.

What to Do to Help Reduce the Risk

If you think someone you know is in immediate danger (e.g., there is a specific plan to

commit suicide and access to lethal means such as a gun), do the following:

- Immediately go with the person to a trusted professional – a teacher, school counselor, physician, or clergyman.
- Go with the person to the nearest hospital emergency department as soon as possible. Do not wait until the person attempts suicide. Major depression is a dangerous disease and medical personnel are trained to deal with it.
- Stay with the person until he or she is with a trusted source of help; do not leave the individual alone.
- Help minimize this person's access to alcohol and weapons or other methods of suicide.
- If there is an emergency situation (e.g., he or she is threatening to jump or has swallowed pills, poison, etc., or has a weapon and is threatening to use it), call 911. Call your doctor or psychiatrist.

Special Alert

Suicide is most likely to occur when it seems that the threat has passed. Many people who have been struggling through a major depression will kill themselves when things seem to be getting better, two or three months into recovery. For some very depressed people, this may be the first time they have had enough emotional energy to act. Others may be overwhelmed by the problems depression has caused.

Protective Factors

Protective factors against youth suicide are less well studied than causes, risks, and

warning signs. Some of the known protective factors are discussed below.

The presence of an important person in the young person's life

As long as there is an emotionally significant person in the teen's life to whom he or she can relate, this will decrease the likelihood of suicide. Many young people have very mixed feelings about suicide and will turn to others for help and support. The "emotionally important" person may be a parent, a teacher, a close friend, or a youth worker. The presence of a strong supportive network of people is especially important to a teenager who has little or no family support.

Good coping skills

The more resourceful and skilled in problem solving he or she is, the more likely a young person will be able to cope with stressful situations. Coping skills are generally related to the personality of the individual rather than his or her intelligence. A teen with good coping skills is more likely to see a stressful situation as a challenge and an opportunity rather than as a situation for despair.

A supportive and caring family

A warm, caring, and understanding family is a good source of support for a young person in distress. Firm guidance, good communication, and family stability are important ingredients for a well-functioning family.

Interests and activities

Teens who are involved in group activities such as team sports, scouts, church youth groups, and school clubs can use these activities to channel their energy and frustration in a socially acceptable way. They learn to relate to others in a semi-structured and fun-filled

environment under the guidance of caring and responsible adults. A teen's self-esteem can be raised by his or her successes in participating in social activities.



What Depressed or Suicidal Teens Need

Teens are not helped by lectures or by hearing all the reasons they have to live. What they need is to be reassured that they have someone to whom they can turn – a family member, friend, school counselor, physician, or teacher – to discuss their feelings or problems. It must be someone who is willing to listen and who is able to reassure the individual that depression and suicidal tendencies can be treated. Treatment is of the utmost importance. Local chapters of the American Psychiatric Association can help by recommending a psychiatrist or a physician with special training in emotional and mental health. Help can also be found through local mental health associations, family physicians, a county medical society, a local hospital's department of psychiatry, a community mental health center, a mood disorders program affiliated with a university or medical school, or a family service/social agency.

Suicide Prevention

Here are the key words to help you remember about prevention of suicide:

- Support

- Understanding
- Identification of plan/intent
- Communication with teenagers
- Identification of any underlying psychiatric disorder
- Depression management
- Esteem improvement

- Parental involvement
- Removal of dangerous materials
- Evaluation after an attempt
- Ventilation of feelings
- Early intervention
- Never ignore suicide threat
- Talk with teenagers
- Involve professionals if required
- Observe change in teenager's behavior
- Nonjudgmental

What about You?

Perhaps you have sometimes felt like ending your life. Do not be ashamed of it. Many people, young and old, share your feelings. Talk to someone you trust. If you like, you can call one of the agencies mentioned in this chapter and talk about the way you feel without telling them who you are. Things may seem very bad at times, but those times do not last forever. Ask for help. You can be helped. You deserve the help!

Appropriate Intervention after a Suicide Attempt

All suicide attempts should be taken seriously, particularly if the young person has planned the suicide. Do not dismiss the attempt as an attention seeking behavior. The seriousness of the attempt is related to the intent of the teenager rather than the method of self-harm. Proper assessment is required after a suicide attempt and this will generally mean professional intervention.

Apart from the suicidal young person, parents and other family members will also need a great deal of support and their needs must not be forgotten.

Parents can do several things to help their teenager after a suicide attempt:

- Ensure his or her physical safety.
- Be available to support the teenager.
- Be caring but do not be over-protective.
- Closely observe him or her but do not be intrusive.
- Return to your normal routine as soon as practical.
- Remove any and all potentially dangerous substances/weapons.
- Discuss issues relating to the attempt only at the initiative of the teen, e.g., do not interrogate him or her.
- Seek help and advice. Do not sweep the problems "under the carpet."

Coping with the Loss of a Loved One

It is estimated that for every suicide that is completed, at least six family members, friends,

and co-workers of each victim are intimately affected and left to survive the terrible loss.

These survivors are often left stunned and troubled by the powerful reactions they experience following the death of someone they loved:

- Shock is often the immediate reaction to suicide, along with a physical and emotional numbness. This temporarily screens out the pain so that it can be experienced in smaller, more manageable steps.
- Depression may appear as disturbed sleep, fatigue, inability to concentrate, change in appetite, and the feeling that nothing can make life worth living.
- Anger may be a part of the grief response, whether directed toward the deceased, another family member, a therapist, or oneself.
- Relief may be a part of the reaction when the suicide followed a long decline into self-destructive behavior and mental anguish.
- Guilt often surfaces as the feeling, "If only I had done..." or "If only I had said..."
- Many survivors struggle with the question, "Why?"

What becomes of these intense, relentless feelings? They usually diminish as months and years go by although some residual feelings may remain unresolved. Recognizing how best to cope with these feelings can help you advance the healing process.

- Maintaining contact with other people is especially important during the stress-filled months after a loved one's suicide. Friends and relatives may feel uncomfortable and unable to offer **consolation**. Take the

initiative to talk about the suicide and ask for help. Doing so will also help them.

- When you feel ready, share with your family and friends your feelings of loss and pain. Understand that each family member or friend may be grieving in his or her own way.
- Children experience many of the same feelings of grief as adults. Remind them that they are still loved by sharing your thoughts and feelings with them and asking them to share theirs with you.
- Anniversaries, birthdays, and holidays may be stressful reminders of the suicide. Plan these days to meet your own emotional needs and those of your family.
- You may actually need to feel guilty for a while before you accept that you are not to blame; you are only human, with human frailties and limitations.
- It is important to go on with your life – to actually enjoy life again, without feeling disloyal to the deceased.
- The survivors of any death need comfort, support, and trusted listeners with whom they can discuss their grief. The **stigma** of suicide and the shame, guilt, and blame that people feel can isolate suicide survivors in their grief. Many survivors find relief in support groups, where they can voice their feelings and learn from the experience of others.
- Individual counseling with a mental health professional or clergy member is another option to help survivors through their grief process.

Conclusion

If you or someone you know suffers from depression or bipolar disorder, you understand all too well its symptoms may include hopelessness and thoughts of suicide. Whether we are experiencing suicidal thoughts ourselves or know a severely depressed person who is, there are ways that we can respond with strength and courage. Suicide can be and often is prevented with the right kind of care, treatment, and support. You have now learned some sound advice on what to do before, during, and after a suicidal episode. Remember that seeking professional help and ensuring the support from family and friends, offers stability and hope to those who are in terrible emotional pain. ❖

Managing Your Stress

PURPOSE

While stress in small doses is a normal, healthy part of life, stress that continues over long periods of time can lead to exhaustion and possible mental or physical illness. This section discusses what causes stress, how it can affect you, and ways that you can manage it. Handling stress in your life and recognizing symptoms of stress in others will make your life more enjoyable and your leadership more effective.

Introduction

The media often portrays the teen years as a carefree time, with few major responsibilities and lots of new and exciting experiences. Many young people know, however, that this is only one side of the coin. You may not have the responsibilities of your parents, but your responsibilities are growing as you grow. New challenges and experiences, while exciting, can also be a bit scary. Expectations for the future can be exhilarating, but they can also result in anxiety and pressure to succeed. As teenagers make their way to adulthood, they experience a range of emotions and changes that can make their high school years very stressful.

What Is Stress?

Stress is the way your body reacts and adjusts to the psychological and physical demands of life. It can be brought on by situations that cause feelings such as fear, irritation,

endangerment, excitement, and expectation. Stress in small amounts is beneficial and needed for motivation, improvement, and growth. It can give you a burst of energy to complete a project or run a race, the control and strength to get through a difficult time, or the inspiration to write a poem or paint a picture. Stress can be an important factor in your achievements and progress.

Yet, times of stress should be followed by times of relaxation to ensure recovery from stress. Experiencing constant stress without a break has a negative effect on people. Stress followed by a period of rest can actually make a person better prepared for the next stressful event. In contrast, stress followed by more stress without recovery in between can exhaust a person and make him or her less prepared to handle the next stressful event. Eventually, constant stress can affect a person psychologically and physically, disrupting normal behavior and resulting in illness.

Physical Effects of Stress

When your mind perceives a situation as stressful, it triggers a series of physical and chemical reactions in your body. These include: increased blood flow to the muscles and brain; decreased blood flow to the skin and digestive organs; shut down of the immune system; and the release of fuel, such as fat, into the bloodstream. These internal reactions to stress will not be obvious to you. However, noticeable results of these reactions include increased heart and breathing rates, muscle tension, **dilated** pupils, cold hands, and dry mouth.

These reactions happen as part of a **fight or flight response** developed in primitive humans to deal with physical threats by either fighting or

fleeing. Either way, primitive man's mind and body placed emphasis on physically responding to stressful situations. Stress provided extra fuel and blood to the muscles while slowing or shutting down other functions.



For modern man, most stressful situations are not life threatening and do not require a physical response. But, being stuck in a traffic jam or pushing hard to finish a report still causes the same physical reactions as those needed for fight or flight. Luckily, once modern man deals with the stress, finishes the stressful activity, or the source of stress goes away, the body and all of its functions return to normal.

On the other hand, if the source of stress continues, is not dealt with effectively, or the person faces nonstop stress, his or her body will not recover its normal state. Eventually, the body's continual reaction to prolonged stress may result in the following physical problems:

- Insomnia
- Grinding or clenching of teeth, especially when sleeping
- Diarrhea
- Indigestion
- Ulcers
- Nausea
- Backaches

- Headaches
- **Migraines**
- Uncontrollable tics or twitches
- Stuttering
- Allergies
- Asthma
- High blood pressure
- Heart disease

Of particular note is the connection between continual stress and heart disease. Most of modern man's stressful situations do not require physical action; therefore the fat pumped into the bloodstream to act as fuel for the muscles is left unused. Ultimately, this fat collects on artery walls and contributes to heart disease.

Psychological Effects of Stress

Generally, the first indications of stress-overload are certain feelings, like irritability or worrying. Paying attention to these feelings and taking action to reduce stress can stop the effects of stress. If, however, initial warning signs are ignored and stress is not relieved, he or she will experience more psychological effects in addition to any physical effects discussed previously.

Psychologically, continual stress may cause:

- Irritability
- Excessive worrying
- **Anxiety**
- Inability to relax
- Forgetfulness
- Disorganization

- Inability to concentrate
- Inability to complete tasks
- Lack of energy
- Trouble with relationships
- Changed eating habits; over- or under-eating with corresponding weight gain or loss
- Use or increased use of alcohol and other drugs
- Lowered self-esteem
- Feelings of discouragement
- Excessive feelings of guilt or self-blame
- Emotional overreaction, like exploding or crying without reason
- Waking from sleep with a sense of doom
- Disinterest in the world and life
- Dissatisfaction with things that were previously satisfying
- Tendency to avoid people and activities, even those that were previously enjoyed
- Unexplained feelings of helplessness or hopelessness
- **Depression**

When stress continues to go unchecked, negative feelings, such as depression and hopelessness, can intensify over time. In severe cases, people can become depressed enough to try to commit suicide. It is important, therefore, to



listen to your feelings, relate them to what is happening in your life, and respond to them promptly before the effects of stress get out of hand.

What Can Cause Stress?

Causes of stress and levels of stress experienced under certain circumstances vary from person to person depending on their personalities and tolerance for different situations and experiences. For example, an outgoing person may find public speaking easy and enjoyable, while a shy person may find it difficult and frightening. On the other hand, the shy person may be quite content to study alone, while the outgoing person may find studying alone nerve-racking. Neither of these people is better or worse than the other – they are simply two different people reacting differently to the same situations. So, do not compare yourself with others when it comes to stress. What is important is that you understand what causes stress for you and learn to manage it before the stress “mismanages” you.

Read through the following items that are common causes of stress for many young people. Think about which ones are stressful for you and whether or not they are things that you can control. Recognizing what causes stress for you is a step toward managing it.

Personal Habits

- Poor time management
- Poor diet
- Irregular sleep habits
- Lack of exercise

Social

- Conflicts with family or friends

- Peer pressure to use alcohol, tobacco, or drugs
- Peer pressure to engage in a sexual relationship
- Pressure to be popular
- Lack of money

Major Life Changes

- Death in the family
- Severe illness in the family
- Parents divorce
- Parent remarries
- Moving
- Changing schools

Environmental

- Air and noise pollution
- Feeling confined
- Overcrowding
- Poor lighting
- Uncomfortable temperature
- Feeling unsafe in your neighborhood, home, or school

Responsibilities

- Participating in too many activities
- Having unrealistic expectations of yourself
- Constant deadlines
- Concern about grades
- Concern about college and career decisions
- Having to work and go to school
- Having to care for younger brothers or sisters

Stress Strategies

There is no way to eliminate stress completely from life. In fact, as previously explained, a stress-free life would not even be desirable, since stress in reasonable amounts aids performance, creativity, and problem solving. Letting stress get out of hand, however, is a common problem in today's hectic world. Fortunately, once you recognize signs of stress-overload in yourself and identify its cause, you can either eliminate the source of stress or learn to manage the stress.



Preventing Stress Overload

The best way to ensure stress does not get the best of you is to follow life-long habits that promote mental and physical well-being. Getting plenty of sleep, eating well-balanced meals, and exercising regularly will help you cope better with stressful situations. Maintaining a positive outlook will help you face difficulties with more confidence. In addition to these commonsense approaches, the following can also promote well-being and prevent stress overload.

- Manage your time with daily, weekly, and/or monthly schedules. In addition to scheduling time for school, study, extracurricular activities, etc., make sure you allow enough time for sleep, unhurried meals, relaxation, and other things you enjoy.

U.S. MARINE CORPS. JROTC
Category 3 – Personal Growth and Responsibility
Skill 2 – Health, Hygiene and Nutrition

- Take care of your problems as soon as possible; avoiding them will not make them go away. The longer you put off dealing with a problem, the more anxious you will feel about it, and the more stress you will create for yourself.
- Keep a journal of the situations you find stressful. For each situation, explain why you find it stressful, how you handled it, and whether or not you believe you could handle it better in the future.
- Develop a hobby and/or participate regularly in an activity you enjoy.
- Take some time every day to do something you find relaxing – whether it is sitting quietly alone and thinking, talking with a good friend on the phone, or laughing at your favorite sitcom.
- Talk over problems with people you trust and who you know are good listeners. Keeping all your thoughts and feelings to yourself can be very stressful. While you may believe you can handle all your problems on your own, everyone needs at least one person to confide in.
- Accept that throughout life you will encounter stressful situations that you cannot or should not avoid. Recognize that you have control over how you approach and respond to those situations. For example, while Shelley dreads going to the dentist, she realizes it is important, and instead of dwelling on how much she hates it, focuses on the benefits of dental care to her overall health and on how good her teeth will look and feel after the dental appointment. Approaching stressful situations positively, and looking to the ultimate outcome of the situation, can lower the amount of stress you experience.
- When you do have a choice, do not participate in activities you find stressful and unrewarding. Often times, young people will take part in activities because their friends do, they believe their parents want them to, or they just believe they must do it all. Only you know which activities are enjoyable and worthwhile to you, which are stressful, and how many things you can do before getting overloaded. Be honest with yourself and with those who care about you when making decisions about participating in certain activities. If taking aerobics with friends makes you more uptight than relaxed, and you would rather get your exercise alone, let your friends know, then do what is best for you.
- Be prepared when you know you will have to face a stressful situation. For example, if you know that you must give a class presentation, plan for it and rehearse it until you feel comfortable with it. By preparing for it, you will be calmer during the time leading up to the presentation and will feel more confident when giving it.
- Do not use tobacco, alcohol, or other drugs. Using drugs does not solve any problems and, more often than not, causes new ones.
- Do not be overly self-critical; remember that making mistakes is part of the growing process and that learning from them will make you more successful in the future.
- If you can, limit the number of changes you make in your life at any one time. For example, if in the same week that you start a new job after school, you also start getting up earlier each morning to jog before school, you are probably putting too much pressure on yourself. To limit your stress level, get used to the new routine of having an after-school

job before you add anything else to your schedule.

- Learn a relaxation technique such as **meditation, visualization**, or deep breathing.

Relaxation Techniques

Try using these relaxation techniques when you notice the warning signs of stress.

Deep Breathing

1. While closing your eyes, take a deep breath in through your nose so that your abdomen expands.
2. Slowly exhale through your mouth, letting all the air out of your lungs and allowing your stomach to contract.
3. Repeat for 5 to 10 minutes.

Meditation

1. Find a quiet place where you can be alone for at least 10 minutes.
2. Close your eyes and try to empty your mind. Many people use the time to listen to music, relax, and try to think of pleasant things or nothing.

Visualization

1. Use your imagination and picture how you can manage a stressful situation more successfully.
2. Whether it's a presentation you must make in class or moving to a new place, many people feel visual rehearsals boost self-confidence and enable them to take a more positive approach to a difficult task.

Progressive Relaxation

1. Sit or lie down in a comfortable position and begin deep breathing.
2. As you inhale, tighten the muscles in your head and neck area.
3. Relax the tensed muscles as you slowly exhale.
4. Continue with all parts of your body, working your way from head to foot.

Letting Off Steam

Sometimes, stressful situations can make you feel frustrated and angry. To keep the stress from getting the better of you and possibly “losing your cool,” try the following:

- Take several deep breaths, releasing tension with each exhale.
- Close your eyes and visualize yourself in a calming situation or place.
- Take a break, if possible; remove yourself from the problem or situation until you feel more relaxed and under control.
- Analyze the importance of the situation. Does it really matter if someone cuts you off in traffic or bumps into you and does not excuse him or herself? Is it worth feeling angry about or wasting your time and energy on? Is it better just to forget it and move on?
- If something is important to you and you can take action, confront the person or situation calmly. If it is not possible to confront the person or problem directly, let off steam, depending upon the situation, by either talking to someone you trust or writing an angry letter, then throwing it away.

- Work off tension with a physical activity, such as screaming into a pillow, taking a walk, or lifting weights.

Stress and Leadership

As a leader, learn to manage your own stress effectively, so that you do not create a negative environment for your followers. Recognize that your behavior can directly affect the stress level of your group of cadets. Stress in groups can be increased to counterproductive and unhealthy levels when leaders:



- Act unpredictably.
- Constantly find fault with their followers, which eats away at their followers' self-esteem and results in increased anxiety.
- Set up win/lose situations in which either they are right and their followers are wrong or vice versa.
- Demand too much or too little of their followers.

Leaders can keep a group's stress to healthy levels by:

- Allowing some participation in the decision-making process, which creates a feeling of trust and usefulness in followers, and promotes team spirit and cooperation within the group.

- Giving credit where it is due and praise when warranted.
- Offering constructive criticism when necessary.
- Having a good working knowledge of the tasks the group needs to perform.
- Monitoring and tracking tasks as they are performed and offering guidance when necessary.

As a leader, you must also be aware of any indications that cadets are feeling or acting "stressed out." If you realize someone is showing signs of stress, let them know that you have noticed they have not been themselves lately, or ask if everything is okay with them. Hopefully, your concern will encourage them to talk to you about how they are feeling. The fact that they are talking about it and you are listening can help to relieve their stress.

Depression

People often say, "Oh, I'm so depressed," when they are having a bad day or because some unhappy event has recently occurred. A certain amount of sadness and grief are normal reactions to certain events in life. However, a person who is having a passing blue mood is not truly depressed. For minor low moods, stimulating or enjoyable activities, such as running or reading a good book, are often all that is needed to raise a person's spirits.

Major depression, on the other hand, is a serious illness that requires treatment. It affects the whole body and involves thoughts, feelings, bodily functions, and behaviors. Most people usually recover from bad events in life after a reasonable amount of time; depressed people do not. And while some cases of depression can be

traced to a specific stressful experience, other cases of depression seem to have no apparent reason for occurring.

An episode of depression can occur once in a person's life or many times. A depressed person's symptoms may last for months, years, or a lifetime. Depression can be so severe that the person cannot function at all. Some people who are chronically depressed are able to function, but never feel really well, content, or happy. They may be unaware that they are even depressed, because they are so used to feeling that way.

Depending upon the individual and the severity of the illness, a depressed person will experience a variety of these symptoms to different degrees. Note that many of these symptoms are similar to symptoms of stress.

- Constantly feeling sad or “empty”
- Feeling hopeless, worthless, and helpless
- Unable to make decisions, remember things, or concentrate
- Loss of interest in normally pleasurable activities
- Irritability
- Disinterest in school, at home, and in other activities
- Not caring about appearance
- Avoiding people; staying alone most of the time
- Difficulty concentrating, remembering, and making decisions
- Problems falling asleep and then problems getting up
- Loss of appetite
- Feeling tired and “slowed down” all the time

- Chronic aches and pains and digestive problems
- Frequent thoughts of death and/or suicide
- Suicide attempts

It is important to remember that depression is a real illness and not caused by personal weakness. Potential for developing some kinds of depression may be inherited, and therefore, biologically related. For instance, **manic-depressive illness** seems to occur in people whose genetic makeup is different than those who do not become ill. However, not everyone who has the genetic makeup for the illness gets it. This suggests that other factors, such as stress, also play a role in the development of the disease.

As with stress, physically active people who eat well and get plenty of sleep tend to feel less depressed than people with less healthy lifestyles. Therefore, if you are feeling mildly depressed, take a look at your current eating, sleeping, and exercise habits, and try to make some changes there. In addition, do things you enjoy, try something different that you have always wanted to do, and talk to friends. Spend time outside; the color green and the sun are known to boost spirits. In addition, try not to pressure or push yourself for awhile.

Likewise, if you know someone who is exhibiting signs of depression, take the time to listen to how they are feeling and offer them your support. Give them the suggestions listed above for lifting their spirits and breaking out of negative habits. Be patient. Often, depressed people are not fun to be around and may even try to push you away, but they really need a friend to understand and encourage them to try to make some changes.

If after giving these suggestions a try, you feel the depression is worsening or becoming long-term, encourage your friend to seek help. Likewise, if you are depressed and believe it is worsening and continuing, seek help. Doctors, psychologists, counselors, mental health clinics, hospitals, family services, social agencies, and private clinics are among the many people and places that offer help for all types of emotional disorders, including depression.

Anxiety

Anxiety is a feeling that everyone experiences occasionally when dealing with things they fear or worry about. Unlike depression, which makes people feel tired and unenergetic, anxiety makes people feel nervous and energetic, almost as if they cannot sit still. Like stress, anxiety in small amounts and for short duration can be beneficial. It can give you a spurt of energy and sharpen your mind. Too much anxiety, however, can be harmful and lessen your ability to perform. For example, while a little anxiety before giving a speech can heighten your powers of recall, projection, and expression, too much anxiety can make you freeze, forget information, and stammer through the presentation.

To keep anxiety from getting the best of you, admit to yourself those things you fear and/or worry about. Then, when you know you will have to deal with one of them, make sure you are thoroughly prepared for it – practice for the speech, study for the test, rehearse the dance routine, workout faithfully before the big meet, etc. Being unprepared will only fuel your anxiety. When you start to worry or feel afraid, remind yourself that it is a waste of your energy, and then visualize yourself doing well instead. Prior to the event or situation, focus on its positive outcomes,

use the relaxation techniques discussed previously, and avoid caffeine, which only increases anxiety.

While it is normal to be mildly anxious about something that frightens or worries us, feeling anxious without a specific reason can indicate an anxiety disorder. When a person experiences anxiety over a long period of time that is related to so many worries and fears the anxiety has become **generalized**, the person is suffering from free-floating anxiety. Often, the effects of free-floating anxiety are the same as stress overload.



When a person experiences anxiety attacks, which are strong, sudden attacks of anxiety for no apparent reason that last only a few minutes, he or she feels panic and extreme stress accompanied by dizziness, faintness, rapid heartbeat, excessive perspiration, and nausea. A person having an anxiety attack is not able to function until the attack passes. Some people have severe anxiety attacks so frequently that they are constantly fearful and unable to cope with many things in life. People suffering from excessive anxiety, whether free floating or anxiety attacks, should seek help from a counselor who can help them reduce or learn to deal with their anxiety.

Conclusion

Humans experience a wide range of emotions and not all of them are pleasant. Yet, even certain uncomfortable emotions such as stress and anxiety are beneficial in small doses. Sometimes because of hectic, hurried schedules and pressures to do too many things or things we do not necessarily enjoy, stress can get out of hand. When you start feeling and showing warning signs of stress overload, step back and take a look at what is going on in your life. Ask yourself what is causing your symptoms of stress, then take care of it or reduce the stress you associate with it.

Meanwhile, to be prepared for the stressful events that will surely pop up throughout your life, maintain a healthy lifestyle so that you are better able to handle whatever life throws your way. Keep negative stress and anxiety in check by doing things you enjoy, learning ways to relax, and thinking positively.

Remember, if these uncomfortable emotions ever become extreme or last for long periods of time, *seek help*. They can be disruptive to your mental and physical well-being and can even be initial indications of mental illness and physical disease. ❖

Drug and Alcohol Use and Abuse

PURPOSE

Americans have become increasingly concerned about the dangers of alcohol and other drug use. Surveys reveal a general intolerance for the use of alcohol by under-aged people and the use of illegal drugs by anyone. Most Americans are prepared to take a stand against such illegal alcohol and other drug use.

The abuse of alcohol and the use of illegal drugs have ravaged families, and have invaded our streets, neighborhoods, and schoolyards. Substance abuse has also spilled over into the workplace and onto the highway.

What do you know about the use and effects of drugs and alcohol? Read on to find some startling information that you may not know.

Introduction

Think about the word “drug” for a moment. It can bring many images to mind – aspirin to stop a headache, a news report about someone arrested for cocaine possession, a prescription for antibiotics from your doctor, a drug-related death covered on the front page of the paper, medical research to develop drugs to cure illnesses, the war on drugs, etc. So exactly what is a drug?

Broadly defined, a drug is any substance taken into the body that changes how the body functions, whether mentally or physically. This includes medications used for the prevention and treatment of disease, as well as any substance to which a person can become **addicted**. Whether

or not a drug is legal or illegal is no indication of whether or not it is addictive. For example, both alcohol and nicotine are addictive drugs. And, just because a drug has a medical purpose does not mean it is not addictive. Many medications, when misused or abused, can cause addiction.

Drug Use, Misuse, or Abuse?

Drug use is taking a legal drug as recommended or prescribed for medical reasons. Drug misuse is taking a legal drug for medical reasons but not as recommended or prescribed. For example, a person who doubles the recommended dosage of a pain reliever because they think it will make their headache go away quicker is misusing a drug. Drug abuse is taking a legal or illegal drug for a non-medical reason in a way that can injure your health or ability to function.

Why Do People Abuse Drugs?

Some people try drugs out of curiosity or as an act of rebellion. Others cannot resist the peer pressure to try drugs. Once people have tried a drug, whether or not they continue to abuse it depends on their individual personalities and situations and on the kind of drug abused.

Most drugs that people abuse produce feelings of pleasure and well-being. When people are unhappy, lonely, or stressed, or are missing something in their lives like friends, love, or satisfying work or study, they may abuse these drugs to avoid their problems or fill a void. But when the effects of the drug wear off, they realize the problems and the void are still there. So, they turn to the drug again.

This cycle is what leads to addiction, a trap that can ruin a person emotionally, socially, economically, legally, and physically. Some drugs are far more addictive than others. For example, a first-time user of crack cocaine has a one in three chance of becoming an addict. This is why it is important to stop yourself before you ever start taking drugs.

Alcohol

Alcohol, legal for those 21 years of age and older, is the most widely consumed and abused drug in the United States. It is socially acceptable in our society for adults to drink in **moderation**. In excess, however, alcohol is a dangerous drug.

In moderation, alcohol causes people to relax and produces a sense of **euphoria**. But the more a person drinks, the more his or her brain is affected by the **depressant** quality of alcohol. This does not mean that the person feels depressed, but that parts of the brain that control behavior are depressed or “put to sleep.” Speech slurs, vision blurs, and judgment and coordination are impaired.

With enough alcohol in the body, the person’s conscious brain becomes entirely depressed, causing the person to lose consciousness. Extremely high levels of alcohol in the body can cause death when the part of the brain that controls breathing and heartbeat is depressed. In most cases, however, before a drinker reaches these extreme states of drunkenness, the body causes him or her to vomit, getting rid of alcohol in the stomach before more is absorbed into the bloodstream. This is one way the body defends itself against alcohol, which is a poison.

Since the liver filters poisons out of the bloodstream, it is the first organ damaged by long-term alcohol abuse. This leads to high blood pressure, a weakened immune system, and excess fat in the blood vessels and fat storage (like the stomach, hips, and legs). Other health problems caused by excessive alcohol abuse include ulcers, kidney and bladder damage, brain damage affecting vision and memory, and an increased risk of cancer.

In addition to the health risks of long-term alcohol abuse are injuries and deaths from alcohol-related accidents and violence. Since alcohol affects judgment, people who have had too much to drink may try dangerous stunts, including driving “under the influence.” Driving drunk is illegal. Alcohol affects vision and coordination and slows reaction time, making a drunk driver a very dangerous individual. Every year, thousands of young people die and tens of thousands are disfigured and crippled in alcohol-related car accidents.



Here are some disturbing statistics from the National Clearinghouse for Alcohol and Drug Information:

- Alcohol and other drugs are a factor in 45.1% of all fatal automobile crashes and one-fifth of all crashes involving injury.

- In 1992, drunk driving crashes claimed the lives of more than 17,000 Americans and injured 1.2 million others. Of those killed, close to one-third were under 25 years of age.
- More than 40% of all deaths of 15- to 20-year-olds result from motor vehicle crashes. In 1993, 40% of the 5,905 traffic fatalities of 15- to 20-year-olds were alcohol-related.

With their judgment affected by too much alcohol, people may also become aggressive. Alcohol is a factor in over 50 percent of murders and child abuse cases, and over 25 percent of rapes and suicides.



Marijuana (Pot, Grass, Weed, Dope, Reefer)

Marijuana comes from the plant cannabis, also called hemp, which is harvested and dried, and then smoked in cigarettes (joints) or pipes. The active chemicals in marijuana affect the brain, altering hearing, taste, touch, smell, and sense of time and space. The effects of marijuana vary from person to person depending on each person's expectations and how much they smoke. In addition, the chemicals in different marijuana

plants vary. People may experience anything from a mild euphoria, to uncontrollable laughter, to **hallucinations**.

Harmful health effects of marijuana use may include: rapid and irregular heartbeat, short-term memory loss, shortened attention span, a weakened immune system, fatigue, and a higher risk of lung cancer. In extreme cases, marijuana abuse can result in **paranoia** and **psychosis**. Like alcohol, marijuana abuse can affect driving ability. As with any illegal drug, marijuana is not tested for safety and purity. It may contain pesticides and molds and may be mixed with other dangerous drugs.

Cocaine (Coke, Crack, Flake, Rock, Snow)

Cocaine is an illegal drug that comes from the leaves of the coca bush. It is a white powder that one snorts into the nose or mixes with water and injects. It is a stimulant that affects the nervous system, providing short bursts of euphoria, a feeling of excitement, increased blood pressure and pulse rate, and alertness. People often use it to increase mental activity and to offset drowsiness and fatigue. However, the intense high of cocaine is followed by an intense low. Repeated abuse of cocaine can result in a strong physical and psychological dependency. The body will ignore all other drives, including hunger, in its drive for cocaine.

Crack is cocaine in a smokeable form. With crack, the user feels the high immediately, but the euphoria fades quickly. It is an extremely addictive drug.



Cocaine abuse causes headaches, chronic fatigue, and destruction of nasal tissue. Pregnant women who abuse cocaine can have infants with birth defects. Cocaine addicts often lose their ability to work and have relationships. Signs of an overdose of cocaine include hallucinations, convulsions, nervousness, and high body temperature. An overdose of cocaine may result in kidney failure and death.

Amphetamines (Speed)

Like cocaine, amphetamines are stimulants. They stimulate the nervous system, increasing physical activity, energy, mental alertness, self-confidence, and producing euphoria. Medically, amphetamines are used to treat obesity, **narcolepsy**, and hyperactivity in children. For example, the amphetamine Ritalin is used to stimulate the brain center that helps hyperactive children sit still and pay attention.

As a drug of abuse, amphetamines are often referred to as “speed.” Many people abuse amphetamines to increase energy and alertness, and in some cases to combat fatigue brought on by use of alcohol, marijuana, or depressants. Because the body builds up tolerance to

amphetamines, greater and greater doses are required to achieve the same effects. Addiction may become severe.

Medically, amphetamines are taken orally, but many abusers inject the drug directly into a vein increasing the risk of overdose and infection. Needles shared to inject the drug can spread **hepatitis** and Human Immunodeficiency Virus (HIV). After an injection of amphetamines, the user experiences intense, short-lived euphoria. An addict may inject the drug several times a day for several days feeling little need for food or sleep. Mental depression and overwhelming fatigue follow abuse, which may cause the abuser to turn to amphetamines again for relief.

In addition to fatigue and depression, other side effects of amphetamine abuse include extreme anxiety, temporary mental illness, and malnutrition. High doses can cause hallucinations, increased body temperature, high blood pressure, convulsions, kidney failure, lack of oxygen, bleeding of the brain, and death. **Withdrawal** symptoms include irritability, depression, disorientation, long periods of sleep, and not caring about anything.

Methamphetamine (Crank, Meth, Ice)

Methamphetamine is a nervous system stimulant like amphetamines that is used medically in much the same way as amphetamines. This drug is abused to produce heightened awareness, alertness, and self-confidence. A smokable form of methamphetamine is called “ice.” Like crack, it produces an intense high without the use of needles and is extremely addictive. Abuse of methamphetamine may result in bizarre behavior, sleeplessness, depression, high blood pressure, increased body temperature, convulsions, heart problems, seizures, and strokes.

Methcathinone, also called “cat” and “star,” is a **designer drug** similar to methamphetamine that can cause paranoia, slurred speech, tremors, extreme weight loss, and sleeplessness.

Barbiturates

Barbiturates are a group of depressant drugs that include phenobarbital (goofballs), pentobarbital (yellow jackets), amobarbital (blue devils), and secobarbital (red devils). They lower body temperature and blood pressure, slow breathing and heart rate, and as such, have many medical uses. For example, doctors prescribe phenobarbital to reduce the frequency of convulsions in epileptics. Unfortunately, people frequently abuse barbiturates, sometimes causing physical and psychological dependency.



Signs of barbiturate abuse include fatigue, blurred vision, confused or slurred speech, lack of coordination and balance, a reduction of mental and physical activity, and decreased breathing. Abusers will often act like they are drunk, but there will be no smell of alcohol. Long-term abuse may result in double vision, depression, and forgetfulness.

Signs of an overdose of barbiturates include dilated pupils, a rapid pulse, shallow breathing, and clammy skin. An overdose can cause coma and death. Barbiturates cause confusion and forgetfulness. Accidental death occurs when a person has taken barbiturates, becomes confused, forgets, and takes more barbiturates. Accidental poisoning occurs when barbiturates are combined with alcohol. Withdrawal symptoms include anxiety, insomnia, tremors, delirium, and convulsions.

Heroin (Antifreeze, Smack, Horse, Harry, Junk)

Heroin is a **narcotic**. Doctors prescribe narcotics to relieve pain and coughs and to cause sleepiness. Heroin, however, is so addictive that it is not used as a medicine and is illegal. Once injected, sniffed, or smoked, it dulls the senses and produces a feeling of euphoria. Other effects include drowsiness and nausea.

Signs of an overdose include shallow and slow breathing, clammy skin, and convulsions. An overdose can result in a coma and death. Once addicted, a person must have more of the drug to keep from experiencing withdrawal symptoms. Symptoms are severe and can include panic, shaking, chills, sweating, cramps, and nausea.

LSD (Acid)

LSD is a very powerful hallucinogen that scrambles and confuses the senses. A tiny drop taken with sugar or food can cause a person to “trip” or experience false visions, smells, and sounds for hours. Some people say these experiences are exciting; others say they are nightmares. Those having a “bad trip” may take dangerous or irrational actions to escape from this imaginary situation. In addition to these affects,

LSD can cause nausea, vomiting, and misinterpretations of time and distance. Some people experience flashbacks of LSD's effects days, weeks, and years after the original trip. An overdose of LSD can result in psychosis, accidental death, and suicide.

PCP (Angel Dust)

PCP, used as a tranquilizer for animals, can cause frightening hallucinations when used by humans. Abuse can result in seizures, coma, and death or in violent, unpredictable behavior. Some abusers have committed murder and suicide.

Psilocybin (Mushrooms, Shrooms) and

Mescaline (Mesc, Buttons, Cactus)

Two other hallucinogens are psilocybin, produced from a type of mushroom, and mescaline, produced from a type of cactus. Like other hallucinogens, use of these drugs can cause hallucinations, perception problems, nausea, vomiting, and, in extreme cases, mental illness, suicide, or accidental death. Mescaline effects, while compared to a mild LSD trip, are often accompanied by sweating and severe abdominal cramps. Eating mushrooms poses another danger since many mushrooms look alike and some are poisonous enough to cause death.

Inhalants (Air Blast)

Inhalants are toxic chemicals such as glue, freon, nail polish, spray paint, and gasoline that are huffed (sprayed into a cloth and held over the mouth and nose) or bagged (sniffed from a bag, bottle, or can) to achieve a brief, mild euphoria. All of these products contain labels warning

against inhaling their fumes because of the hazards involved. Some inhalants used medically are also abused like amyl nitrate, which relieves heart pain and nitrous oxide, which relieves anxiety.

Risks involved with inhaling these chemicals include nausea; dizziness; vomiting; headaches; unconsciousness; pneumonia; permanent brain and nerve damage; bleeding of the brain; eventual liver, brain, and kidney cancer; and death due to heart failure and suffocation. Effects of inhalants are very unpredictable and depend on what chemical or chemicals are inhaled and how much. Brain damage and death may result after only one use depending on the inhalants involved.

Ecstasy (XTC, Love Drug)

Ecstasy is the street name for methylenedioxymethamphetamine (MDMA), a chemical substance that combines methamphetamines with hallucinogenic properties. It is a designer drug that closely resembles cocaine. Ecstasy produces euphoria that lasts several hours, heightens pleasure, and may even produce hallucinations in high doses. Ecstasy is taken orally and may cause mood swings, overly friendly behavior, insomnia, anxiety, and nausea. In extreme cases, abuse may result in seizure and death. It is also known as X-TC, Adam, Clarity, and Lover's Speed.

Ecstasy's effects can last up to 24 hours. The drug produces immediate side effects, and some—such as confusion, depression, sleep problems, anxiety, and paranoia—can occur weeks after it is taken.

Ecstasy is considered a "club drug," which is the term used to describe drugs that are commonly used at nightclubs and rave parties to enhance a person's senses. MDMA, a stimulant

and hallucinogen, is the most popular club drug, with side effects similar to methamphetamine.

Like all club drugs, ecstasy is a combination of other illicit drugs. Users cannot be completely sure what ingredients are in the drug they are taking. The drug quality of ecstasy may vary significantly from one dose to another, so that one dose may be more potent than another and the drug may be combined with other drugs without the user's knowledge. Because many different recipes are used to make ecstasy, the risk of death and permanent brain damage are heightened when some substances are combined. It is available in tablet, capsule, or powder form; some manufacturers of the drug package it in capsules or generic tablets to imitate prescription drugs. The average cost is between \$7 and \$30 per pill.

Among the variations of the drug is a new substance, herbal ecstasy, which is composed of ephedrine (ma huang) or pseudoephedrine and caffeine from the kola nut. Sold in tablet form, this drug may cause permanent brain damage and death (NIDA, Club Drugs: Just the Facts, 2000).

The drug, which induces intense euphoria and lowers inhibitions, is particularly trendy among middle class teenagers and young adults and has exploded in popularity in recent years. The DEA estimates 2 million ecstasy tablets are smuggled into the United States every week.

The drug is appealing to youth who attend raves because it increases the visual appeal of rave light shows and gives them energy so that they can dance for hours at a time. However, youths may not be aware of the many risks associated with using ecstasy. The drug produces many side effects, including nausea, hallucinations, chills and sweating, increases in body temperature, involuntary teeth clenching and muscle cramping,

tremors, blurred vision, confusion, anxiety, paranoia, and depression.

Other serious side effects commonly exist. Ecstasy users tend to experience a decrease in sexual and emotional inhibitions. This increases the likelihood of youths under its influence having unprotected sex and sex with multiple partners. Users have nicknamed it the "hug drug" since it encourages physical interactions. However, because their judgment is impaired, these youth are susceptible to being infected with sexually transmitted diseases.

The problem for parents and others who worry about ecstasy use is that the drug shows none of the obvious physical signs of other illegal drugs. It is not considered physically addictive, and there is no odor or slurred speech to detect.

Raves

The dance parties known as "raves" are widely considered notorious havens for illegal drugs like ecstasy. By definition, raves are parties where pulsating music, special effects such as steam, and paraphernalia such as pacifiers, chemical light sticks, and flashing light rings are used to support highs from club drugs.

Raves themselves are nothing new. They have been popular since the late 1980s, originating within the gay club culture of after-hours' parties. The music, notable for its highly regimented and precise dance beats, began first in Detroit with club DJs sampling early disco records and blending them with new, faster beats. The music then moved to England, where the sound changed again and was exported back to the U.S., where it continues to evolve.

Rohypnol (Roofies, Forget Pill, Date-Rape Pill)

Rohypnol is used legally as a medical sedative in Europe and Latin America. As a drug of abuse, it is called roofies, forget pill, and date-rape pill. At first, it produces an alcoholic type of high, then heavy **sedation** and short-term memory loss that lasts up to eight hours. It earned its reputation as the date-rape pill by being slipped into the drinks of females, who were taken advantage of in a state of sedation brought on by the drug and then unable to remember exactly what happened to them. In addition to the drawback just discussed, dangers of abusing rohypnol include impaired motor skills and slow respiration.

Signs of Drug Abuse

- Dilated pupils
- Missed appointments
- Lying
- Unexplained increases in energy followed by fatigue and depression
- Anxiety
- Memory loss
- Pale and perspiring skin
- Runny nose
- Nosebleeds
- Hyperactivity
- Jumpiness
- Ability to go without food or sleep for long periods of time
- Suspiciousness and paranoia
- Lack of care with personal appearance

- Inability to explain what money is spent on

All of these signs of drug abuse may also be caused by other medical, psychological, or personal problems. If a friend or family member is showing one of the signs, it is in no way an absolute indication that he or she is abusing drugs. Before jumping to conclusions, consider how frequently these signs occur and if the person showing the signs has a logical explanation for them. Expressing concern and asking questions is the best way to get a person to confide in you.

If a friend or family member is abusing drugs, make it clear that you care about him or her, but that you do not approve of his or her habit. Encourage the person to break the habit and support any effort on the part of the person to do so. Find out where the person can seek help and encourage him or her to get it.



Indicators of Alcohol Abuse

Alcohol abuse has an adverse effect on logic, coordination, social behavior, and school or job performance. The symptoms or warning signs of alcohol abuse include the following:

- *Hangover* – the nausea, headache and dry mouth following heavy drinking.
- *Blackout* – The temporary loss of consciousness, vision, or memory as the result of substance abuse.

- *Fatigue* – the depressed after-effect of alcohol abuse; the state of mind after too much partying and too little rest.
- *Illness* – The more frequent the abuse, the more likely the need for some type of medical assistance. Frequent calling in sick for work or school, tardiness, and/or below standard performance. Wild weekends have a tendency to borrow from Fridays and overlap Mondays.
- *Conflict* – The frequent substance abuser may become abusive in social situations. Sometimes the “life of the party” goes beyond what is considered socially acceptable behavior and becomes an embarrassment to him/herself and to others.

There are many indicators of a pre-alcoholic or an early alcoholic situation. Some things to look for, in others as well as in yourself, that may indicate an alcohol problem are among the following:

- Cannot control drinking; gets drunk when intending to stay sober.
- Using alcohol as a tranquilizer to quiet nerves.
- Other people say you drink too much.
- Being in trouble with the law, your family, the people you work with, or with teachers, administrators or fellow students at school as a result of drinking.
- Being dependent on alcohol and not being able to stop drinking for a week or more.
- Your doctor tells you that your drinking is impairing your health.
- Drinking before you go to a party just in case there will not be drinking there.
- Having a drink in the morning to cure a hangover or the shakes.

- Development of a tolerance for alcohol.

There is evidence to indicate that a tendency toward alcoholism could be hereditary. People who have a family member with a drinking problem should be extra careful of their drinking habits.

Social Consequences of Alcohol and Drug Abuse

Alcohol and other drug use is often a factor in many of this country’s most serious and expensive problems, including violence, injury, child and spousal abuse, HIV/AIDS and other sexually transmitted diseases (STDs), teen pregnancy, school failure, car crashes, escalating health care costs, low worker productivity, and homelessness (Center for Substance Abuse Prevention’s Discussion Paper on Preventing Alcohol, Tobacco, and Other Drug Problems, 1993). Former Secretary of Health, Education and Welfare Joseph A. Califano, Jr. estimates that in 1993, the cost to society of alcohol, tobacco, and other drugs was nearly \$400 billion – about \$1,608 for every man, woman and child in the nation (Center for Addiction and Substance Abuse, Columbia University, The Cost of Substance Abuse to America’s Health Care System, Report 1: Medicaid Hospital Costs, 1993).

Crime

Crime is closely related to alcohol and other drugs. The U.S. Department of Justice, Bureau of Justice Statistics publishes reports in both 1991 and 1992 entitled Crime in the United States. In its reports, the Justice Department claimed that there were more than 1.1 million arrests for illicit drug violations, almost 1.4 million arrests for driving while intoxicated, 480,000 for liquor law violations, and 704,000 arrests for

drunkenness. The total of all these arrests comes to 4.3 million arrests for alcohol and other drug statutory crimes, over one-third of all arrests in this country.

The need for preventing alcohol and other drug problems is clear when you examine the following statistics:

- Alcohol is a key factor in up to 68% of manslaughters, 62% of assaults, 54% of murders/attempted murders, 48% of robberies, and 44% of burglaries.
- Among jail inmates, 42.2% of convicted rapists reported being under the influence of alcohol or alcohol and other drugs at the time of their offense.
- In 1990, over 60% of men and 50% of women arrested for property crimes (burglary, larceny, robbery), tested positive for illicit drug use. It should be pointed out that these individuals were voluntarily tested.
- The number of potential years of life lost to alcohol- and drug-related injuries equals the number of potential years lost to cancer. The potential years of life lost to alcohol- and drug-related injuries exceeds those years lost to heart disease. Cancer and heart disease are the two leading causes of death in the U.S.



Domestic Violence

Studies of domestic violence frequently reveal high rates of alcohol and other drug involvement. This is not unexpected since both alcohol and other drug use is known to impair judgment, reduce inhibition, and increase aggression. Similar to the link between domestic violence and substance abuse, alcoholism and child abuse, including incest, seem tightly related as well. Abusers tend to be heavy drinkers and those who have been abused have a higher probability of abusing alcohol and other drugs over the course of their lifetime. Studies reveal a strong association between battering incidents and alcohol abuse. The combined problem of the abuse of alcohol and other drugs is even more likely to be connected with the more severe battering incidents than is alcohol alone.

The Link to Risky Sexual Behavior

Alcohol and other drug use is linked to risky sexual behavior. This link represents a significant threat to the teens' health. Substance abuse may impair a teen's ability to make judgments about sex and contraception. This places young men and women at an increased risk of unplanned pregnancy, sexual assault, or becoming infected with a sexually transmitted disease.

Suicide

Researchers "cite a wide range of potential suicide triggers, from loss of employment or loved ones, aging and physical impairment. But, in most cases, they agree there is an underlying psychiatric illness – primarily depression, followed by alcoholism and substance abuse" ("The Mystery of Suicide," *Newsweek*, April 18, 1994). In one study of youth suicide, drug and alcohol abuse was the most common characteristic of those who attempted to kill

themselves. Fully 70% of these young people frequently used alcohol and/or other drugs. (U.S. Department of Education, “Youth & Alcohol: Selected Reports to the Surgeon General,” 1993).

Economic Costs of Alcohol- and Drug-Related Abuse

Incidents of drug and alcohol abuse exact a huge economic cost in this country. Alcohol-related injuries alone cost an estimated \$47 billion annually. A 1993 study reported that illnesses and injuries caused by the use of alcohol, tobacco, and other drugs accounted for nearly 40% of the medical costs at one large metropolitan hospital (Center for Substance Abuse Prevention’s Discussion Paper on Preventing Alcohol, Tobacco, and Other Drug Problems, September, 1993).

U.S. companies spend over \$100 billion each year addressing workplace alcohol- tobacco- and other drug-related problems (Working Partners: Confronting Substance Abuse in Small Business, National Conference Proceedings Report, U.S. Department of Labor, 1992). Studies show alcohol and other drug abusers:

- Are less productive;
- Use three times as many sick days;
- Are more likely to injure themselves or others; and
- Are five times more likely to file worker’s compensation claims.

For more information about alcohol and drug related problems, call the National Clearinghouse for Alcohol and Drug Information at 1-800-729-6686.

What Can You Do to Remain Drug-Free?

- Fill your life with activities and people you enjoy.
- Believe in yourself.
- Practice saying no before you are actually in a situation where someone offers you drugs, so you will not hesitate to say no when the time comes.
- Think through the consequences of abusing drugs. Where will drugs lead you in life? How long will your body remain healthy if you abuse drugs? How many of your plans can drugs ruin?
- Remember that drugs do not solve problems; they create them.



Conclusion

When drugs are properly used, they can cure illness and save lives. When abused, however, drugs can destroy lives and cause death. It is important to understand that, while people often abuse drugs to find happiness and fulfillment, drugs only create more problems and unhappiness. To keep from falling into the trap of drug abuse, stay smart, strong, and active. Say “no.” Recognize the different drugs that are abused in our society and what affect they have on people’s health and lives. You can set an example of an informed, drug-free individual. ❖

Drug and Alcohol Abuse: Prevention and Intervention

PURPOSE

Since the early 1960s, there has been an alarming increase in drug use in the United States. In 1964, four million Americans had tried an illegal drug. By 1999, that number had risen to 87.7 million (1999 National Household Survey on Drug Abuse).

Drug use among teens and even younger children has been steadily increasing for the past several years. According to the 1998 National Center on Addiction and Substance Abuse, teen marijuana use is up almost 300 percent since 1992. According to the Monitoring the Future Study in 1999, 55 percent of high school seniors reported having used an illegal drug, only 7 years before that, 41 percent said they had. Between 1991 and 1999, illicit drug use among younger children, 13 and 14-year-olds, increased by 51 percent, up from 18.7 percent to 28.3 percent.

Much is being done in the areas of intervention and prevention of drug and alcohol abuse.

Introduction

As a teenager, you have many new pressures in your life, as well as many new challenges and experiences. Along with these new opportunities come added responsibilities. While adjusting to these changes that are a part of becoming an adult, you are constantly making decisions. Sometimes you make good decisions

and other times you may make mistakes. Making mistakes is normal and part of the learning process. Of course, nobody likes to make them, so try to analyze each situation beforehand to minimize possible mistakes.

When it comes to drugs, however, it is extremely important to make the right decision before you make a mistake. Making just one wrong choice could result in disastrous consequences. Having to juggle pressures from your family, school, activities, job, and friends may overwhelm you at times. The many new situations and emotions you experience can sometimes seem unbearable with no end in sight. Unfortunately, drugs and people who use them, and are willing to share them are readily available with what seems like a quick solution or retreat to any problem.

Pressures? You Need a Plan

Pressures from society, your family, friends, and even the pressures you place on yourself may sometimes make it difficult for you to say no to drugs. Our culture often encourages quick solutions to problems. Many people would like to believe that taking a pill could cure all types of problems, but there is no magic pill or cure-all. Pills and other drugs only produce chemical reactions in your mind and body that create artificial feelings and unhealthy side effects.

Oftentimes, advertising, movies, and television shows glamorize drug and alcohol abuse. It may appear that all the beautiful, fun people are drinking at a bar or taking a refreshing break with the “crisp, clean” smoke of a cigarette.

These types of false messages reinforce the idea of drug abuse as a normal and desirable part of life. You may see your parents drink at parties; you may know students who use drugs. You may even be curious about drugs' effects, or tempted to use them to relieve uncomfortable emotions. Though all these situations may make drug abuse attractive to you, the reality of drugs' effects is far from glamorous. The pleasure drugs may give is short-lived and unreal. They never solve problems; only you can do that. You cannot function if drugs are a problem in your life.

What you need is a plan of action to cope with all the pressures to abuse drugs. Once you decide that you do not want drugs to be a part of your life, you must develop strategies to resist these pressures as well as healthy alternatives to drugs.

Handling Internal Pressures

Accept and analyze your emotions.

If you are feeling something unpleasant, take time to consider the cause of your emotions instead of trying to avoid feeling bad. If you do not address the cause, the uncomfortable feelings will return to bother you. Also, remember that certain amounts of anger, sadness, boredom, and frustration are normal human responses to life that must be accepted.



Seek out help when you feel overwhelmed

Members of your family, teachers, counselors, and friends can help you. There are also many places that offer help for specific problems, such as divorced parents, shyness, alcoholism, or lack of reading skills. You can ask a counselor or instructor at school about them or look for yourself in the phone book. If you are willing to make the effort, there are people willing to help you. Seek them out.

Find alternatives to drug use

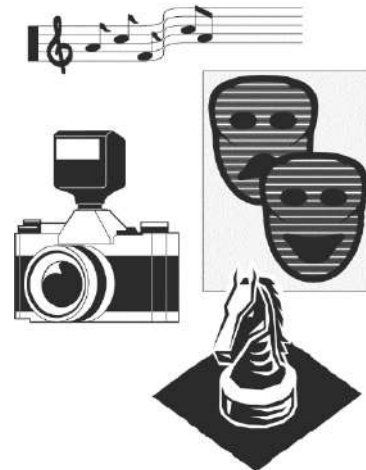

If your routine is a big yawn, take a look around and see if there is an activity that looks interesting to you. There are better, safer, more rewarding experiences in life than using drugs. They involve doing something that you find exciting, satisfying, meaningful, and challenging. Some alternatives include sports, dancing, playing music, theater, volunteer work, tutoring, writing, reading, playing games, photography, or crafts. You can find out about other alternatives by asking organizations in your community about programs they offer. Check with schools, community colleges, adult education programs, YMCA, YWCA, Boys' or Girls' Clubs, libraries, etc. Photography, auto

mechanics, painting, chess, drama, singing, playing an instrument, and part-time employment are among the many activities you could do that would add new challenges to an unexciting routine. Of even greater importance, these activities pay you back with a real sense of accomplishment and heightened self-esteem as you get better and better at them. Drugs cannot give you these benefits; they can only temporarily produce a false feeling of well-being. In the long run, drugs always take far more than they give and leave the user with nothing but problems.



Release excess energy and learn how to relax.

If you cannot sit still in your seat during class, maybe you are not exercising your body enough. Physical activities such as running, walking, biking, tennis, basketball, weight training, martial arts, skiing, and dance, among others, keep your body in shape while relaxing and focusing your mind during mental activities.

Practice patience

If there is a situation that makes you feel bad, you cannot think of a way to change it, and nothing you do seems to work, what can you do? Wait! You may not like that answer, since waiting is difficult, especially for young people. But there will be times in life when the situation is out of your control. This fact is understandably hard for young people to accept. However, change is certain and inevitable. If you wait and stay alert, new solutions and opportunities will become available to you in time. To cope with the stress of a difficult situation until things do change, follow the tips in the chapter on stress to learn coping strategies. People on drugs never learn the lesson of patience; they miss opportunities to change their lives for the better.

Resisting External Pressure

Learn how to refuse drugs effectively

Standing up to peers when they want you to do something that you do not wish to do can be very difficult. When you go against the crowd, you risk rejection – and that is scary. However, every time you make a decision to do what is best for you and those you care about, you become a stronger person. You also gain the respect of those people who are your true friends. Your strength and your decisions may even give others the courage to do what is best for them as well.

In today's school environment, saying no may not be easy, but it is definitely worth the effort.

Prepare yourself for situations where you may be offered drugs

Visualize different circumstances and different behaviors you can use to refuse offers of drugs. Have answers ready:

- No, thanks, I'd rather do something else.
- No, I already feel fine.
- No, thanks, I already have enough problems.
- No, I'm running in the meet tomorrow (interviewing for a job, taking an important test, acting in a play, etc.).
- No, thanks, I'll pass.
- No, I don't like the way it smells, tastes, makes me feel, etc.
- No, I'm not feeling too well, and I don't want to get worse.
- *No!*

If you do not feel comfortable saying no in a situation, find a way to remove yourself from the scene. Suddenly remembering an appointment or some other excuse can get you away from the situation and give you time to think of another way of handling it next time. The important thing is not to do the drugs.

Analyze media and advertising

Does advertising accurately project the image of drugs? Who gains by making products appear glamorous and sophisticated? People who sell products want you to buy them and will use psychological techniques in advertising to create a demand for their goods. Companies that sell beer, cigarettes, and non-drug related products, such as cars, have one main goal – they want your money.

Your goal is to do what is best for you. Some products that advertising tries to sell you are opposed to that goal. Your defense against advertisements for products that are useless or harmful is the power to read between the lines. Think about the message an ad is giving and decide for yourself whether it is accurate.

Legal Risks of Illegal Drug Use

Before deciding to drink alcohol or abuse drugs, remember that abuse of legal drugs, taking illegal drugs, underage drinking, and driving while intoxicated are all against the law. By endangering their lives and the lives of others, users become a societal problem, often requiring legal punishment.



Drug laws vary from state to state, but the general trend throughout the United States is toward stiffer penalties for those convicted of drug possession, drug selling, and alcohol-related car accidents. People convicted of these crimes must pay higher fines and must often spend time in jail. If you think experimenting with drugs might be fun, think about how much fun you would have spending time in a prison.

Prevention History

Historically, various organizations, communities, and governmental agencies founded drug abuse prevention programs based on the theory that people used drugs because they were

ignorant of the consequences of such use. According to this theory, failure to recognize any negative effects of drugs resulted in neutral or even positive attitudes toward experimenting with drugs.

During the 1960s, drug education programs focused on providing information. Administrators of those programs often called them “fear arousal messages,” because they dealt with health and social consequences of drug use. However, these programs were somewhat ineffective because youths said that the messages themselves lacked **credibility**.

By the 1970s, social scientists began to address more personal factors that influenced drug abuse behavior among children and adolescents. Studies showed that a close association exists between drug abuse and a person’s attitudes, beliefs, and values, as well as other personality factors such as feelings of self-esteem, self-reliance, and **alienation**.

One prevention approach that grew from this research was **affective** education. Rather than focusing on drug abuse behaviors, affective education focused on the factors associated with use. This approach attempted to eliminate the reasons for using drugs by creating a school climate that was supportive of students' social and emotional needs. These programs often focused on training the students in effective decision-making skills. Students in these programs worked to clarify their values, analyze behavior consequences, and identify alternative behaviors.

Some of the other leading prevention approaches in the 1970s focused on alternative activities to drug use. These programs involved youths in community projects to reduce alienation, while others provided alternative opportunities for recreation, socialization, and informal education.

Prevention Today

Today, many schools have drug prevention programs. Sometimes these programs directly involve the students. For example, high school students might perform as “peer” teachers for 7th graders. Some studies have shown that prevention programs led by peers are more effective than programs led by adults. The health programs led by peers were more successful at preventing nonsmokers from smoking. Through role-playing, students acted out situations requiring resistance to peer pressure. Students also made social commitments not to smoke or use drugs.



For most youths, substance abuse appears to be the result, in large part, of social influences. Thus, teaching youths to resist these influences is one approach to the prevention of use. However, not all youths use drugs for the same reason or respond to the same prevention approach. Thus, it may not be effective to focus on any single prevention approach, and it is important to explore multiple strategies.

Changing the Social Environment

Substance abuse prevention programs that focus on changing an individual's negative social environment can be very successful in reducing the risks of early drug use. By changing a teen's surroundings, he or she is more likely to develop positive personal attributes and behaviors and will then be more likely to choose alternatives to drug and alcohol use.

In some instances, teenagers live in a high-risk social environment that supports and even encourages the use of drugs and alcohol. Often a teen has only negative role models to follow and easy access to drugs and alcohol in his or her home or community. However, not all teenagers in high-risk environments choose to experiment or use drugs or alcohol regularly. Teens who possess positive **intrapersonal** (within the individual) values, attitudes, and skills may be most successful in resisting drugs and alcohol, despite a negative, high-risk social environment. These teens are able to choose non-drug alternatives that meet their needs.

Research suggests prevention efforts should focus on both changing the environment and building positive values, attitudes and skills (such as decision-making), rather than only focusing on a single factor. These findings also suggest that teen drug and alcohol use is **functional**. In other words, the functions that drugs serve an individual (reducing pain, providing excitement, etc.) need to be replaced with much more positive activities and rewards that will meet the teenager's needs. In addition to replacing the functions served by drugs, substance abuse prevention efforts should focus on those factors (social environment, negative role models, easy access to drugs and alcohol, etc.) that seem to be predictors of drug use.



Some research suggests that prevention efforts should focus on this functionality and provide alternative behaviors for drug use rather than simply trying to suppress the underlying need or reason for using drugs or alcohol. This research also suggests that peers and parents should offer teens positive rewards for choosing alternatives to drug use. .

Reaching Youth Outside the Classroom: Big Brothers & Sisters of Wichita, Kansas

For nearly a century, Big Brothers & Sisters of America (BBBSA) has been providing adult support and friendship to children. Through a careful matching process, volunteers interact regularly with young people in one-to-one relationships. Of the 514 local BBBSA agencies nationwide, the Big Brothers & Sisters program in Wichita, Kansas, is the largest with over 1300 matches of adult **mentors** with area youths in 1999. The goals of this mentoring program are to prevent destructive behavior and promote positive attitudes and habits among youths through support, role modeling, and exposure to healthy activities. A study conducted in 1992-1993, with nearly 1,000 boys and girls ages 10-16 in eight cities, found that following 18 months of a

mentoring program where the mentors met about three times each month produced several positive results. Little Brothers and Sisters were:

- 46% less likely to begin using **illicit** drugs;
- 27% less likely to begin using alcohol; and
- 53% less likely to skip school than their peers.



Another Outside the Classroom Success Story: Self-Expression Teen Theater, Toledo, Ohio

Self-Expression Teen Theater (SETT) trains youths to educate their peers about the dangers of alcohol and other drug use, premature sexual activity, and other risky behaviors, and explores positive, alternative activities. The program was begun in 1986 in response to a needs assessment, that revealed Hispanics and African Americans in Toledo had high rates of alcohol and other drug use. Since it began, SETT has trained over 1,200 peer educators, given more than 500 performances, and conducted over 200 youth-led workshops focusing on substance abuse and its relation to violence.

SETT targets primarily Hispanic and African American youths ages 11-18 to be peer educators. These young people conceive, write, and perform skits on topics including violence, substance abuse, teen pregnancy, suicide, and academic failure. Performances illustrate the

importance of communication between young people and adults, and provide youths with information on prevention and treatment services where they can seek help. The troupes perform in schools, churches, public housing projects, and malls.

In the program's target area of Toledo, 60% of all students graduate from public high schools. However, 93% of SETT peer educators graduate from high school, and 87% are attending or have graduated from college.

An In-School Program: Reconnecting Youth, Midland, Texas

Reconnecting Youth is a school-based drug prevention program targeting high-risk high school students. The program is designed to reduce drug use and aggression, as well as academic failure and dropping out of school. Reconnecting Youth includes a semester-long course, school-bonding activities, and a school system crisis response plan. The Reconnecting Youth class is taught 55 minutes each day and includes four modules: Decision-Making, Personal Control, Self-Esteem Enhancement, and Interpersonal Communication. Studies documented that Reconnecting Youth improved academic performance; decreased drug use; reduction in anger, depression, hopelessness, aggression, suicidal behaviors, and stress; improved self-esteem, self-control, bonding to school, and social support.

School-Based Programs that Reach Beyond the Classroom

In schools that have components beyond the basic classroom program, they aim their efforts at changing the adolescent's social

environment. Newsletters to parents emphasize the importance of communication with their child about drug abuse and include homework assignments such as structured interviews to help achieve better communication. Peer leaders clarify school rules as they tell their classmates the rules on drugs and the reasons for those rules. An alternatives week, planned by peer leaders, promotes and reinforces healthy behaviors. Finally, program administrators facilitate smoking cessation programs for interested parents.



Drug Abuse Prevention

There are many ways in which you can become involved in drug abuse prevention. You might be able to volunteer at drug treatment and rehabilitation centers. Look in the phone book under “drug abuse” for information and prevention programs. You may be able to find several local sources for preventive information. There are also toll-free numbers that provide information on drug abuse and prevention.

Many major hospitals have chemical dependency hospitals affiliated with them. These hospitals may offer professional treatment for

alcoholism and drug dependency. Some may offer services such as seminars on drug recovery, depression, or anxiety and other individualized programs.

Help and/or information are available from many private and public agencies, facilities, and people. Drug treatment centers and clinics specialize in treating people with drug problems. Hospitals treat on an in- or out-patient basis. Mental health centers can treat people with drug problems by dealing with underlying problems. Public health agencies and social service agencies can provide practical advice and make referrals. Halfway houses provide residential treatment for those with drug problems.

Treatment and Referral Services

The National Drug Information and Treatment Referral Hotline (1-800-662-HELP), and the Substance Abuse and Mental Health Services Administration (SAMHSA’s CSAT) provide drug-related information to individuals seeking local treatment programs and direct friends or family members to support groups or services.

To learn more information on alcohol and other drugs, write or call: National Clearinghouse for Alcohol and Drug Information (NCADI) at 1-800-729-6686 for assistance in English or Spanish. PREVLine (Prevention on-Line), a 24-hour Web-based prevention information portal and search engine, is maintained by CSAP and is accessible through the Internet at <http://www.health.org>.

If you need help with a cocaine problem, call Cocaine Anonymous at 1-800-347-8998 or write for free materials to: 3740 Overland Avenue, Suite G, Los Angeles, CA 90034.

For information about inhalant prevention, contact the National Inhalant

Prevention Coalition, 1615 Guadalupe Street, Suite 201, Austin, TX 78701, or call 1-800-269-4237.

Don't forget to call your local police department, health department, and local drug prevention organizations for more information on drugs.

Alcohol Abuse Prevention

Alcoholics Anonymous (AA) is a worldwide group of men and women who help each other maintain **sobriety**. Members who attend meetings share their recovery experiences freely with others who may have a drinking problem. The AA program consists basically of "Twelve Steps" designed for personal recovery from alcoholism. The organization functions through almost 97,000 local groups in 114 countries. The program has helped more than 2,000,000 problem drinkers. Several hundred thousand alcoholics have achieved sobriety in AA, but members recognize that their program is not always effective and that some may require professional counseling or treatment.

Look for Alcoholics Anonymous in any telephone directory. In most urban areas, a central AA office can answer your questions or put you in touch with AA members. If AA is not in your local directory, write the General Service Office, P.O. Box 459, Grand Central Station; New York, NY 10163 or call (212) 870-3400

Al-Anon is a worldwide organization that offers help to families and friends of alcoholics. Al-Anon meetings are held in 115 countries. There are over 24,000 Al-Anon and over 2,300 Alateen groups worldwide. Members receive support through a mutual exchange of experiences about how an alcoholic has affected their lives. Alateen is a fellowship of young Al-Anon

members, usually teenagers, with someone else's drinking problems affecting their lives. Young people come together to share experiences, strengths, and hopes with each other as they discuss their difficulties. They can also encourage one another to learn effective ways to cope with their problems.

To contact the nearest Al-Anon or Alateen Group, call the local Al-Anon Information Service (Intergroup) in metropolitan areas, or write: Al-Anon Family Group Headquarters, Inc., 1600 Corporate Landing Parkway, Virginia Beach, VA 23454; (Email) wso@al-anon.org; (Phone) (757) 563-1600; (Fax) (757) 563-1655.

There are many other places that people can get help for problems caused by alcohol. They can talk with family, friends, a school counselor, or a doctor. Look in the yellow pages under "alcohol" or "alcoholism." Use referral services and get information provided by the local affiliate of the National Council on Alcoholism (1-800-NCA-CALL). Remember, it is important to seek help and support for people with drinking problems.



Driving Under the Influence

Disturbing Statistics

According to the National Highway Traffic Safety Administration (NHTSA), there were 41,611 total traffic fatalities in 1999. Of those, 38% or 15,786 were alcohol-related.

Estimates are that 2,104 persons aged 16-20 died in alcohol-related crashes in 1998. (NHTSA, 1999)

An estimated 308,000 persons were injured in crashes where police reported alcohol was present – an average of one person injured approximately every 2 minutes.

Approximately 1.4 million drivers were arrested in 1998 for driving under the influence of alcohol or narcotics. This is an arrest rate of 1 for every 132 licensed drivers in the United States. (NHTSA, 1999)

About 3 in every 10 Americans will be involved in an alcohol-related crash at some time in their lives.

MADD

According to Mothers Against Drunk Driving (MADD), underage drinking is America's No. 1 youth drug problem, killing 6.5 times more young people than all other illicit drugs combined.

Founded in 1980, MADD is a non-profit grassroots organization with 600 affiliates and approximately two million members and supporters nationwide. MADD's prevention efforts focus on drunk driving and underage drinking; these efforts have helped save more than 183,000 lives since the organization's founding. Although alcohol-related traffic deaths have decreased by more than 40 percent since MADD's founding, drunk driving still remains the nation's most frequently committed violent crime.

Since its founding, MADD has helped pass more than 2,300 anti-drunk driving and underage drinking laws. MADD was instrumental in the passage of the national 21 minimum drinking age law in 1984, as well as the 1995 “zero tolerance” provision of the National Highway Systems Law making it illegal for those under 21 to drive after consuming alcohol. On October 23, 2000, President Clinton, with the support of MADD, signed a federal law that will require each state to pass .08 BAC as the legal limit or lose a portion of their federal highway funding. MADD is working to pass .08 BAC (blood alcohol concentration) laws in the 31 states that do not yet have this law. MADD also advocates for passage of a federal constitutional amendment for victims' rights and stricter penalties for repeat and higher-risk drunk driving offenders, in addition to other key legislation in states across the country.

MADD is always looking for dedicated individuals interested in starting a chapter or Community Action Team (CAT) in areas where MADD does not have a local presence. Because the procedures for starting a chapter vary by area, MADD's website recommends that you contact their national office at 800-438-6233 and ask the operator for the Field Services Coordinator for your state.

DID YOU KNOW?

Drinking is the third leading cause of death in the United States – right behind heart disease and cancer.

Know When to Say When

“Know When to Say When,” which was in effect from 1985 to 1999, was a nationwide consumer education campaign developed by Anheuser-Busch that encouraged consumers to be responsible when they drink. It aimed at normally responsible, law-abiding citizens who only needed reminders of their legal and moral obligations to themselves and others. The purpose of the campaign was to help create a climate that strongly discourages “situational abuse.” The campaign involved a series of television commercials, a movie, billboards, and newspaper advertisements that reminded consumers not to overindulge. On September 12, 1999, the company launched a new advertising campaign, “We All Make A Difference.” It reflected the fact that today's challenge is not to convince the public that drunk driving is inexcusable and wrong (the public already knows that). Instead, it aimed to reinforce the good practices of drinkers who exercise personal responsibility, designate a driver or call a cab, and build on the momentum of the positive trends.

SADD

Students Against Destructive Decisions (SADD) is a school-based organization dedicated to addressing the issues of underage drinking, impaired driving, drug use, and other destructive decisions and killers of young people. SADD's mission is to provide students with the best prevention and intervention tools possible to deal with the serious issues young adults are facing today. **Empowerment** is the foundation of SADD. The idea of empowerment is to build students' confidence and ability to create changes and manage behavior in a way that results in healthy choices. SADD promotes a “no use” message of alcohol and other drugs and

encourages students not to participate in activities with destructive consequences.

For information about starting a SADD chapter at your school, start by calling SADD National Headquarters at 1-877-SADD-INC, or filing a request for information on SADD's website, <http://www.saddonline.com>. You can also order a SADD chapter starter kit from SADD Custom Products at 1-800-886-2972.

Important Tips to Know

Your knowledge of the following tips can possibly save a life when you are in a position to influence family members, friends, or other adults who are planning and/or attending a social function that includes alcohol.

As Responsible Adults...

- Recognize that every social occasion does not have to include alcoholic beverages.
- If alcohol is served, place limits on the amount available. Estimate how much alcohol to have on hand, based on the number of guests and the length of the party. As a guideline, plan on one drink per guest per hour; then, purchase only that amount.
- Provide other activities when serving alcoholic beverages. Drinking should not be the main purpose of any activity.
- Create a climate that respects individual choice by providing attractive non-alcoholic drinks. Be conscious of the drinking age and remember that serving alcohol to those under 21 is illegal!
- Serve snacks so that guests do not drink on an empty stomach, and to slow down alcohol **absorption**.

- Create a climate that discourages **overindulgence**, but assume responsibility for guests who overindulge. See that they get home safely by providing or arranging transportation or invite them to stay later or overnight.
- Keep a list of telephone numbers of emergency health care, police, and taxi services in case you have a problem.

As Responsible Guests...

- Regard alcohol as the highly toxic substance it is; understand its effects on the body, brain, and thought processes.
- Set a limit on the consumption of alcohol that is well within personal limits, remembering that this will vary from time to time.
- Eat while drinking – such as low salt snacks or a meal.
- If they have exceeded their limit, ask for a ride home with someone who has not been drinking.

As Friends...

- Discourage anyone who appears to be under the influence of alcohol from driving.
- Call a cab for anyone who appears to be under the influence of alcohol.
- Remember: A brief uncomfortable confrontation may save the life of a friend and others.

As Concerned Citizens...

- Talk about the dangers of drinking and driving to those who are overindulging. Ensure they understand the dangers of drinking and driving, the effects of alcohol on driving performance, and the consequences of

being arrested and convicted of driving under the influence.

- Be a positive role model. Your attitudes and behavior regarding drinking and driving will influence others, especially minors.
- Support education and prevention activities in local schools.
- Practice other safety measures such as using seat belts and child restraints for protection from drunk drivers.
- Join an organization on the local, state, or national level that is working to educate people about the dangers of drinking and driving.
- Support strong laws and enforcement of those laws. Let government know your feelings.

Drug abuse prevention programs have evolved from the need for action and the need to reach the target school-aged population. The result is a heavy reliance on school systems, use of academic time, and involvement of educators in implementation. But do not just count on the school system. Everyone has the opportunity to become involved in community efforts to make citizens aware of the drug problem and how to prevent drug abuse.



What Else Can You Do?

Even if no one close to you has a problem with alcohol, work to maintain a positive self-image and promote drug-free living. Join an anti-drug club or start one – there are many nationwide. You may choose to become involved with Students Against Destructive Decisions (SADD) or initiate a Safe Ride Home program at your school and sell cards that people who have been drinking can use for free taxi rides.

Help in the fight to keep your school drug-free. Organize a poster competition at your school in which students address the need for education and responsibility in the consumption of alcohol. Develop positive peer pressure and teach the harmful effects of alcohol abuse. Remember that there is strength in numbers and that encouraging alcohol-free activities can prevent problems from ever starting.

Intervention Strategies

Where Do You Find Help?

Chances are you know one of the millions of Americans who have a problem with drinking or other drugs. You may care a great deal about that individual, but perhaps, even though you want to help this person, you're not certain how to go about it. Maybe you think you cannot help. Maybe you are hesitating because you think they may not like you anymore if you confront them with the truth about their drinking or drug use. Maybe you even feel that people can only want help if they have "hit bottom." People who are dependent on alcohol or drugs cannot quit without help, and they do not have to reach "rock bottom" before getting the help they need. You can help with a process called **intervention**.

What is an Intervention?

An intervention is a process generally conducted by a trained intervention professional. In an intervention, family members, friends, and coworkers in a loving, caring way confront the person as a group and present the reality of that person's drug or alcohol problem. These genuinely concerned people present clear, factual information about the effects the person's drinking or drug abuse has on those who care about them. For example, the person who abuses drugs or alcohol may be missing work or school as a result of hangovers or too much "partying" and may lose their job or fail school. The individual on drugs or alcohol may have missed family outings, had some embarrassing experiences, or shirked their responsibilities. A successful intervention usually results in the person with the problem accepting that their behavior is a sign of their addiction to alcohol or drugs, recognizing their need for help, and getting the help they need. It also can preserve a family or save a friendship.

Intervention is not a long, complicated process, but to ensure the intervention is successful, it is best conducted with the help of a professional. For more information, contact: the National Council on Alcoholism and Drug Dependence, 20 Exchange Place Suite 2902, New York, NY 10005; (Phone) 212-269-7797; (Fax) 212-269-7510; (Website) <http://www.ncadd.org>; (Email) national@ncadd.org.

What Else Can You Do to Help a Friend?

If a friend you know is having problems and is considering abusing drugs to relieve the pain, you can be of help just by being there to listen and by affirming your personal decision that drugs are not a good way to deal with problems. In some cases, this may be all that is needed – a

caring and strong presence can go a long way as can an informed discussion about what a particular drug can do to the mind and body. There may be other situations, though, which require specific and professional help that you are not prepared to give.

When you realize that someone you know may have a drug problem, there are some choices of action you need to make. If you are not prepared to go to an intervention professional, there are some other choices of actions you can take that can also help.

If you decide to speak to a friend, here are some guidelines that you should consider in planning how and what you could do to help.

Guidelines to Consider

- Make certain the timing is right. Talk to your friend when he or she is sober or straight – before school is generally a good time.
- Never accuse your friend of being an alcoholic or a drug addict, but do express your concern. Try not to blame your friend for the problem. If you do, he or she might be “turned off” right away.
- Talk about your feelings. Tell your friend you are worried, and how it feels for you to see him or her drunk or high on drugs.
- Tell your friend what you have seen him or her do when drinking or using drugs. Give your friend specific examples. Tell your friend you want to help.
- Speak in a caring and understanding tone of voice, not with pity but with friendship.
- Be prepared for denial and anger. Your friend may say there is nothing wrong and may get mad at you. Many people with alcohol and other drug problems react this way. When

confronted, many users will defend their use, blame others for the problem, or give excuses for why they drink or use other drugs.

- Find out where help is available. You could offer to go with your friend to get help, but be prepared to follow through. Doing this will convince your friend that you really care about him or her.
- You need to tell your friend that you are worried about him or her, and that someone who can help needs to be told. Your friend might get really angry with you, but if you say nothing, things may get worse and your friend may be in more danger. Remember, that if they do not get help, they can develop serious psychological problems such as suicidal depression, and serious physical problems such as liver or brain damage; some will die from an overdose.

Convince the person to seek help

Be prepared with the names of people and agencies that can provide help.

Tell a responsible adult

You may be reluctant to tell a responsible adult, such as an instructor or counselor, that you are concerned about the person because it feels like betraying someone. However, especially in cases where you know the person is using life-threatening drugs or participating in dangerous situations, you are really doing this person a favor. Your action may save a life.

If you know of someone selling drugs...

You need to report someone selling drugs to an appropriate authority. People who sell drugs have passed the point of having a personal problem. Drug dealers are hurting others.

Find out what types of help are available at your school and in your community for people with problems. Know the proper procedure for reporting drug-related incidents, and above all, show the cadets whom you lead that you care about their well-being and are willing to help. Your example and your support can have a positive impact on those around you.



First Aid For Alcohol or Drug Overdose

What can you do if a friend gets into trouble and overdoses on a drug or consumes excessive amounts of alcohol? If the situation permits, before doing anything else, call poison control or the nearest emergency room and tell them what the person has taken, describe his or her symptoms, and seek advice on what action to take. In general, follow these rules:

- If the victim is conscious and took the overdose in the last thirty minutes, make him or her vomit.
- Keep the victim awake and conscious.
- Protect overly active, aggressive, or panic-stricken victims from hurting themselves, you, or others.

- Place an unconscious victim on his or her side, so that if the victim vomits, he or she will not choke or drown in it. This position also allows good respiration.
- Monitor the victim's breathing.
- Maintain the victim's body temperature.
- Reassure the victim that he or she will be okay.
- If the victim is having **convulsions**, do not put anything in his or her mouth. Clear away furniture and sharp objects, and move the victim only if he or she is near a fire, glass door, stairway, or other danger.
- Keep any evidence, including any material vomited, to help medical personnel determine what and how much the person took.
- Call for emergency medical services or transport the victim to a hospital or doctor.

Conclusion

Become involved as an individual. Talk to your friends and neighbors about drugs. Ask them to join you in your community's attack on drugs. Reach out a helping hand to your community – join the fight against drugs and become a part of the solution. Your assistance could save a life. ❖

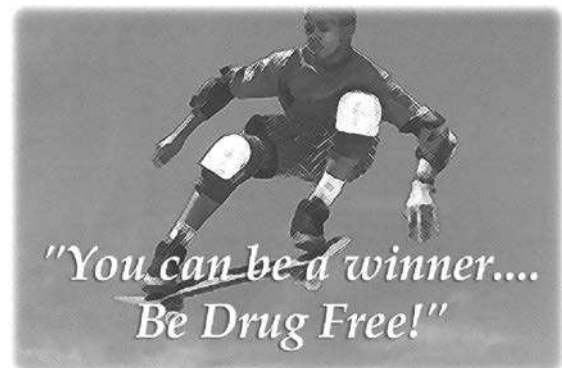

Tobacco – Use and Effects

PURPOSE

According to the Center for Disease Control, tobacco use continues to be the leading preventable cause of death in the United States. Statistics show that more than 400,000 people die each year, and United States residents spend more than \$50 billion in direct medical costs annually as the result of tobacco use.

These are very persuasive statistics and should make you think carefully about any decision you make about using tobacco and tobacco products. This chapter presents the information you need to make an informed decision that can affect you now and for the rest of your life.

Introduction

Want to fit in? Do your friends smoke or use smokeless tobacco products? Want to look older than you really are? Want to be just like those teens in the advertisements that wear the coolest clothes, appear youthful, vigorous, maybe even rebellious or sexy? Guard against the hype and slick advertising techniques that smart tobacco advertisers would have you buy into. Tobacco and tobacco products are really not glamorous as the advertisements would have you believe.

- Did you know that cigarettes contain formaldehyde – the same substance used to preserve dead frogs?

- Did you know that the same cyanide found in rat poison exists in cigarette smoke? You breathe it whether you are a smoker or just hanging around people who smoke.
- And how about the nicotine in cigarettes? You probably already know that it is addictive, but did you know that it is also a potent insecticide found in bug spray?



Surgeon General Reports

The Centers for Disease Control (CDC) in their 1994 report from the Surgeon General states that teens who smoke are three times more likely than nonsmokers to use alcohol, eight times more likely to use marijuana, and 22 times more likely to use cocaine. Smoking is considered a **gateway** drug, that is, it is the opening or “gate” to the path to further drug use and abuse. Smoking is associated with a host of other risky behaviors, including fighting and engaging in unprotected sex. Be smart. Know the facts before you make the decision to use tobacco or tobacco products. Read on and take a look at some more really convincing information – relevant to you and to your health!

Surgeon Generals Report: Smoking Is Bad for You

Among young people, the short-term health effects of smoking include damage to the respiratory system, addiction to nicotine, and the associated risk of other drug use. Long-term health consequences of youth smoking are reinforced by the fact that most young people who smoke regularly continue to smoke throughout adulthood (CDC, Preventing tobacco use among young people – A report of the Surgeon General, 1994, p. 15). But smokers are not the only ones whose health can suffer. Their tobacco smoke can be hazardous to the health of others. And smokeless tobacco, such as chew or snuff, can also have serious health effects, specifically causing cancer of the mouth.

Three Major Components

Cigarettes, cigars, pipes, chew, and snuff all contain tobacco and there are three major components that make up tobacco, each having its own ill effects. One such component, tar, causes a variety of cancers and contributes to **emphysema** and other respiratory problems. For this reason, people often choose to smoke low-tar cigarettes, but even low-tar cigarettes can be unsafe because smokers often end up smoking more, using these brands. **Carbon monoxide**, also found in tobacco, restricts the oxygen-carrying capacity of the blood, and can often cause insufficient heart operation. **Nicotine**, the substance in tobacco believed to cause dependency, is absorbed into the bloodstream, reaching the heart and brain within a few seconds of the onset of smoking.

Nicotine

Nicotine is a **stimulant** to the brain and the central nervous system. A stimulant is any substance that quickens the functional activity of an organ or part. During smoking, nicotine is absorbed quickly into the bloodstream and travels to the brain, causing an addictive effect.

Short-term or immediate effects to the body include:

- Increase in blood pressure
- Increase in heart rate
- Thickening of blood
- Narrowing of arteries
- Decrease in skin temperature
- Increase in respiration



- Stimulation of the central nervous system
- Vomiting
- Diarrhea

Addiction and Dependence

The Surgeon General Reports concluded that cigarettes and other forms of tobacco are addicting. In addition, the factors that determine

tobacco addiction are similar to those that determine heroin and cocaine addiction.

There are more people addicted to nicotine and tobacco than to any other drug. Being addicted or dependent basically means the same. When a person is addicted or dependent on nicotine, he or she feels as if they need nicotine in order to function normally. The term “addict” tends to make people think of a desperate individual living in the back alleys of a big city. However, anyone from any background in any place can become addicted or dependent on a substance. People who are dependent have great difficulty refusing the substance they have been abusing.

Teenagers Making the Decision to Smoke

Even though it is illegal for minors to buy tobacco products, at least 4.5 million adolescents (aged 12-17 years) in the United States smoke cigarettes. Every day, more than 6,000 adolescents under the age of 18 years in the U.S. try their first cigarette and more than 3,000 adolescents under the age of 18 years become daily smokers. The younger people start smoking cigarettes, the more likely they are to become addicted to nicotine. The American Cancer Society reports that nearly 75 percent of daily smokers who think they will stop smoking in five years are still smoking five to six years later. The decision to use tobacco is nearly always made in the teen years, and about one half of young people usually continue to use tobacco products as adults.



Physical and Psychological Dependence

Physical Dependence

There are two types of dependence – physical **dependence** and psychological dependence. A person with a physical dependence on nicotine, after being deprived of it for any length of time, can experience any of the following withdrawal symptoms:

- Drop in pulse rate
- Drop in blood pressure
- Disturbance of sleep
- Slower reactions
- Tension
- Restlessness
- Depression
- Irritability
- Constipation
- Difficulty in concentration
- Craving for tobacco

Quitting and Withdrawal

Among adolescents aged 10-18, about three-fourths of daily cigarette smokers and daily smokeless tobacco users report that they continue to use tobacco because it is really difficult for them to stop. About 93 percent of daily cigarette smokers and daily smokeless tobacco users who previously tried to quit, report at least one symptom of nicotine withdrawal. Young people who try to stop smoking suffer the same withdrawal symptoms as adults who try to quit (Centers for Disease Control and Prevention, *Morbidity and Mortality Weekly Report* 1994, Vol. 43, pp. 746-750).

Although the symptoms of withdrawal may cause discomfort for a brief period of time, the benefits to a person who quits smoking greatly outweigh an addiction to nicotine.

Psychological Dependence

A person has a psychological dependence on nicotine when, after being deprived of this substance for any length of time, he or she feels a powerful motivation or craving to continue using it. Since the mind and body work together very closely, it is often difficult to tell the difference between physical and psychological dependence. The mental craving for nicotine may be so powerful that it seems to be a physical need.

Tobacco is Tobacco is Tobacco

Smoking cigarettes, pipes or cigars is not the only problem. People can also use tobacco products orally in the forms of chewing tobacco (by placing a wad between the cheek and teeth and sucking on it) and snuff (by placing a pinch between the lower lip and teeth). Regardless of the choice of tobacco product a person uses, each can harm the body in different ways. Although there are short-term or immediate effects to using tobacco products, research has also identified the long-term effects of using tobacco products.

Long-term effects of using tobacco products include:

- High blood pressure
- Blockage of blood vessels
- Depletion of vitamin C
- Reduction in the effectiveness of the immune system
- Cancer of the mouth, throat and lungs
- Cancer of the upper respiratory tract

- **Bronchitis** and/or emphysema
- Stomach ulcers
- Weight loss
- Dryness and wrinkling of the skin
- Production of abnormal sperm in males

Is It Better to Smoke Cigars?

No! Cigars can do more harm than the same number of cigarettes because cigars typically contain more tobacco and more nicotine than cigarettes do. Many people think that if they do not inhale cigar smoke then cigars cannot be harmful. This is just not true. Harmful heat and smoke still enter the body and nicotine is absorbed into the blood stream through the interior of the cheeks. Since cigarettes are not as strong as cigars, the average smoker will smoke more cigarettes than cigars.

What About Smokeless Tobacco?

Tobacco smoke contains thousands of chemical agents, including 60 substances that are known **carcinogens**, or cancer-causing substances (National Cancer Institute, *Cancer Rates and Risks*, 4th edition, National Institutes of Health, 1996, p. 70).

Smokeless tobacco, such as chew and snuff, affect the body somewhat differently than smoking cigarettes, cigars or pipes. Because the tobacco is held against the interior of the lip rather than inhaled as smoke, smokeless tobacco can cause cancer of the mouth. Also, just like when a person smokes cigars, nicotine is absorbed into the blood stream through the interior of the mouth. The harmful effects of one can of snuff are equal to about sixty cigarettes.



Smokeless tobacco can cause gum disease, mouth, cheek, throat, and stomach cancer. Smokeless tobacco users are 50 times more likely to get oral cancer than non-users. Those users who do not develop some type of cancer are still likely to have signs of use, including stained teeth, bad breath and mouth sores (National Clearinghouse for Alcohol and Drug Information). There is no safe form of tobacco.

Smokeless tobacco use among young people is a continuing problem. According to the National Center for Chronic Disease Prevention and Health Promotion (CDC), data from recent school-based surveys indicate that about one in five male students in the ninth through twelfth grades use smokeless tobacco.

Diseases Associated with Smoking

Some of the diseases associated with long-term tobacco smoking include chronic bronchitis, emphysema, coronary heart disease, and lung cancer.

Lung Cancer

Lung cancer is the leading cause of death among women today. The CDC says men who smoke are 22 times more likely to die from lung cancer than non-smokers. Women who smoke are 12 times more likely to die from the disease. Pipe and cigar smokers are more prone to dying

from cancer of the mouth and throat than non-smokers.

Statistical studies have long shown that people who do not smoke live longer than those who do; and since the 1950s, scientists have statistics that connect smoking and lung cancer.

Cardiovascular Diseases

Cigarette smoking is a major risk factor for heart attacks (sometimes fatal) in both men and women. According to the CDC, smoking triples the risk of dying from heart disease among middle-aged men and women. Studies also show an increased risk of dying from stroke, aneurysms, high blood pressure, and other **cardiovascular** illnesses.

Respiratory Diseases

Smoking is cited as a risk for dying of pneumonia, chronic bronchitis, or emphysema. The CDC says people who smoke increase their risk from bronchitis and emphysema by nearly 10 times.

Other Effects

Studies have pointed to smoking as a risk in vision loss among older people, mental impairment later in life, Alzheimer's disease, and other forms of dementia.

Smoking also reduces the effectiveness of prescription and over-the-counter medications.

Pregnant women who smoke can pass nicotine and carbon monoxide to their baby through the placenta. Research indicates this can prevent the baby from getting the oxygen and nutrients it needs to grow. This can lead to fetal injury, premature birth, or low birth weight. A mother who smokes can also pass nicotine to her baby through her breast milk.

Despite the labels required by federal law warning individuals about the hazardous effects of using tobacco products, use continues.



Secondhand Smoke

The harmful effects of smoking do not end with the smoker. The tobacco smoke in the air is called environmental tobacco smoke (ETS) or secondhand smoke. Breathing it can be a hazard to your health and to the health of those around you.

Recent research has indicated that non-smokers who breathe in **second-hand smoke** (smoke that escapes from the burning end of a cigarette as well as the smoke exhaled by the smoker), can have an increased risk of lung cancer, heart disease, and respiratory disorders. The more you are around secondhand smoke, the greater your risk for health problems. Each year it causes about 3,000 lung cancer deaths in U.S. adults who do not smoke. ETS is so harmful that the U.S. Environmental Protection Agency (EPA) has classified it as a “Group A” carcinogen. “Group A” carcinogens are the most toxic substances known to cause cancer in humans.

Did You Know?

- Secondhand smoke in a crowded restaurant can produce six times the pollution of a busy highway.

- Secondhand smoke causes 30 times as many lung cancer deaths as all regulated pollutants combined.
- Secondhand smoke makes hair and clothes stink!
- Secondhand smoke ruins how food smells and tastes to you.
- Secondhand smoke causes reddening, itching, and watering of the eyes.
- Secondhand smoke fills the air with many of the same poisons found in the air around toxic waste dumps.

As the public becomes more aware of the dangers of inhaling secondhand smoke, the legislation protecting the rights of non-smokers continues to increase. Smoking is increasingly being banned in both public and private places.

Tobacco and Athletic Performance

Research has shown that students who participate in school sports are less likely to be regular or heavy smokers. Students who play at least one sport are 40 percent less likely to be regular smokers and 50 percent less likely to be heavy smokers. (American Cancer Society) Here are some additional facts about tobacco and athletic performance from the Centers for Disease Control:

- Nicotine narrows your blood vessels and puts added strain on your heart.
- Smoking can wreck lungs and reduce oxygen available for muscles used during sports.
- Smokers suffer shortness of breath almost three times more often than nonsmokers.
- Smokers run slower and cannot run as far, affecting overall athletic performance.

- Smoking hurts young people's physical fitness in terms of both performance and endurance. Even competitive runners will feel the harmful effects of smoking (CDC, Preventing tobacco use among young people, p. 28).

What Can You Do?

Recommendations from the CDC

- Know the truth. Despite all the tobacco use you see on TV and in the movies, on music videos, and in magazines, most young people, adults, and athletes do not use tobacco.
- Make friends, develop athletic skills, control weight, be independent, be cool...play sports.
- Do not waste money on tobacco!
- Get involved. Make your team, school, and home tobacco-free. Teach others. Join community efforts to prevent tobacco use. You can do it!



Ways to Say “No”

Today's young adults experience a great deal of peer pressure to experiment with or use alcohol and tobacco. One way to deal with this peer pressure is to be prepared to offer quick responses when such situations occur. The following are some quick-response ideas that you can use to plan ahead.

- I can't – my mom can smell it on me when I get home.

- I already get grounded if I miss my curfew. So I'd hate to think what would happen if my dad caught me smoking.
- Not for me, thanks. I'm not into chemicals.
- No thanks. I'm allergic.
- I'm into health.
- If the coach finds out, I'll have to run laps.
- No thanks. I just read a new study on its harmful effects.

But If You Already Use Tobacco Products and Want to Quit...

Before you quit, think about the following questions, write down your answers, and then keep these responses somewhere you will be able to see them as a reminder:

- What do I get out of using tobacco products?
- Why do I think I can give it up?
- Why do I want to quit?
- When I tried in the past to quit, what helped? What did not help?
- What situations will be tough for me after I stop? What can I do to avoid smoking?
- Will my friends who continue to use tobacco products feel hurt? How will I handle their reaction to my quitting?
- Who can help me get through the tough times? Friends? Family? Former users?

Exercise helps a great deal. Eating right is also helpful. Be certain to eat fruits and vegetables, whole grain cereals and pasta, and avoid fats. Get plenty of sleep. All of these things will make quitting easier. Finally, remember that

looking good is about clean-smelling breath, clothes, and hair, plus feeling healthy and good.



Relapses

Most **relapses** occur in the first three months after a person quits. You have a much better chance of quitting for good if you avoid those things that trigger your urge to smoke.

- Try to get other smokers (perhaps your parents or your good friends) to quit with you. It is difficult to refrain from using tobacco products with others around you who smoke or chew, so avoid them if you cannot convince them to join you in quitting.
- Some people gain weight; others do not. Deal with one problem at a time. Work on quitting smoking first.
- It is common to experience mood swings or depression. You may get edgy, which will make you want to smoke. If problems persist, talk to your parents or a doctor.
- Dry mouth, cough, or scratchy throat, and edginess can be temporary side effects of withdrawal. Although somewhat annoying, these symptoms mean your body is adjusting.
- You will be thinking about smoking. Do something. Get out. Exercise. Scream. Walk the dog. Just stay busy!

Keep a list of your triggers. If something makes you want to smoke, dip, or chew, write it down. Keep the list in your pocket so you always know what caused them and what you can learn from them.

Additional Resources

Information about the health risks of smoking is available from the following:

Office on Smoking and Health (OSH)
National Center for Chronic Disease Prevention
and Health Promotion

Centers for Disease Control and Prevention
Mail Stop K-50, 4770 Buford Highway, NE
Atlanta, Georgia 30341-3724

1-800-CDC-1311 (1-800-232-1311)
770-488-5939

FAX Information Service: 770-332-2552
<http://www.cdc.gov/tobacco>

If you suspect you have a problem with nicotine, cigarettes and/or other drug use, please contact the National Drug Information and Treatment and Referral Hotline at 800-662-HELP (4357). They can supply you with the following:

- Printed materials
- Treatment services in your state
- Referrals for treatment
- Alcohol treatment services
- Adolescent and family services in your state

To learn more about tobacco, or obtain referrals to programs in your community, contact:

SAMHSA's National Clearinghouse for Alcohol
and Drug Information 1-800-729-6686

TDD 1-800-487-4889

linea gratis en espanol 877-767-8432

<http://www.health.org>

Other organizations that promote tobacco prevention include: the American Cancer Society, American Heart Association, American Legacy Foundation, Association of State and Territorial Health Officials, National Association of County and City Health Officials, National Association of Attorneys General, National Association of Local Boards of Health, National Center for Tobacco-Free Kids, National Conference of State Legislatures, National Governors' Association, Pan-American Health Organization, and World Bank.

Conclusion

While the damaging effects of tobacco use remain obvious, it has also become clear that even non-users of this substance can experience problems. More and more people are being affected every day. Because any use by young people is considered harmful and can have a dramatic effect on your life, challenge yourself and others to pledge not to use this dangerous substance. ❖

You Are What You Eat

PURPOSE

A healthy lifestyle includes good nutrition as well as exercise. You need to eat well in order to maintain an exercise program. After all, just as a car will not run without fuel, your body will not work properly without the right nutrients. Eating a balanced diet also helps you maintain proper weight and lowers your risk of disease. This lesson explains the importance of a proper diet to your health.

Introduction

Americans live in a fast-paced environment and frequently eat on the run. Eating on the run too often, however, may affect our nutrition and weight. We can end up consuming too many **fats** and too few vegetables and fruits, leaving us overweight and/or **deficient** in certain **nutrients**. Learning to eat balanced meals, even on the run, contributes to our overall well-being by:

- Helping to maintain proper weight
- Providing energy for physical activity
- Supplying nutrients for good health

Balancing Calories

You must eat in order to fuel your body. The more active you are, the more fuel your body requires. Even if you remain very still, your body uses a certain amount of energy, or **calories**, for basic functions that work automatically all the time to keep you alive – like your heart beating,

your lungs inhaling, and your nerves delivering information. You do not have much control over the amount of calories used for these basic functions. Some people's bodies naturally use more calories to sustain their basic functions, some less. We often say that those who use more have a high **metabolism**, meaning they can eat more and not gain weight.

Your body also uses calories to do everything else throughout the day, from brushing your teeth, to studying, to stretching. Unlike your basic functions, however, you can control how many calories you voluntarily use throughout the day by how active you are. For example, you will use more calories if you choose to walk for an hour instead of watching television for an hour. Also, the more effort you put into an activity, the more calories you burn. For example, jogging uses more calories than walking leisurely.



When your body uses the same amount of calories daily that you eat daily, your weight stays the same. If you eat more calories than your body uses, your body stores the unused calories as fat and you gain weight. If you eat fewer calories than your body needs, your body uses the stored fat for energy and you lose weight. It's a balancing act between numbers of calories eaten and calories used.

Out to Lunch with Karen and Andrea

Karen wonders why she keeps gaining weight – 10 pounds over the last year. One Saturday, she and her friend, Andrea, meet at the local fast food restaurant for lunch. While they wait in line, Andrea says she played tennis that morning. Karen admits she slept late and watched television. Andrea orders a small soda and a salad with grilled chicken and light Italian dressing. Karen orders a double hamburger with mayonnaise, hold the lettuce and tomato, large French fries, and a large chocolate milkshake.

Andrea shakes her head and asks Karen if she ever eats fruit or vegetables. Karen shrugs and says “sometimes.” Andrea explains that she eats hamburgers and French fries every once in a while – in fact, she had that for lunch a few days ago which is why she ordered a salad today. Andrea tells Karen that eating fruit and vegetables more often than fried foods and sweets helps her maintain her desired weight, and she feels better, too. Karen thinks about this for a moment as they sit down to eat.

Perhaps if Karen had access to the following calorie counts, she would reconsider what she ordered. Keep in mind that most people need only between 2000 and 3000 *total* calories a day. (Note: The calories listed here are approximate; actual calories of these food items at different restaurants may vary.)

KAREN'S ORDER

Plain 1/4-pound hamburger with bun	540
Mayonnaise (1 tablespoon)	100
French fries (large order)	360
Chocolate milkshake (large)	<u>540</u>
TOTAL	1540

ANDREA'S ORDER

Salad with grilled chicken	200
Light Italian dressing (2 tablespoons)	50
Small soda	<u>150</u>
TOTAL	400

Even if Karen did not want a salad, she could cut her calories considerably by ordering a single hamburger with mustard and ketchup, a small milkshake, and a regular order of fries. She could also have lettuce and tomato on the burger in order to eat some vegetables. Her new calorie intake would look like this:

KAREN'S NEW ORDER

Plain single hamburger with bun (2-ounce patty)	275
Lettuce (1/2 cup)	5
Tomato (1 slice)	5
Mustard (1 tablespoon)	8
Ketchup (1 tablespoon)	15
French fries (regular order)	220
Chocolate milkshake (small)	<u>330</u>
TOTAL	858

If Karen really wants to lose those extra 10 pounds, however, she should skip the milkshake and replace the fries with a small salad and light dressing. This would reduce her calorie intake to about 400 for lunch. Then, she should get some exercise like her friend Andrea. Playing tennis for an hour uses three times as many calories as watching television for an hour. If Karen sticks to eating sensibly and exercises daily, she will start using more calories than she eats, losing those extra pounds.

The Importance of a Proper Diet to Your Health

Just as important as eating the correct amount of calories to supply your body with energy and maintain proper weight is what you eat to get those calories. If you eat like Karen every day, you are giving your body too much fat, cholesterol, salt, and sugar, and denying your body many necessary nutrients. Many health problems relate to poor diets, and these problems can start when you are young. At your next physical examination, ask your doctor about your cholesterol, blood pressure, and blood sugar levels. You may be surprised to find you need to change your diet to improve your health.

What Should You Eat?

The United States Department of Agriculture developed the Food Guide Pyramid to indicate how many servings of six different food groups you should eat daily to get the nutrients your body needs. If you follow these guidelines, you will get enough **vitamins** and **minerals** to keep your body's processes functioning properly, and you will have enough **carbohydrates**, **protein**, and fat to supply your body with energy. When you do not get enough of certain nutrients, you increase your risk of disease. For example, if you do not get enough calcium, a mineral found in milk products, almonds, sardines, leafy green vegetables, and beans, you might develop **osteoporosis**.

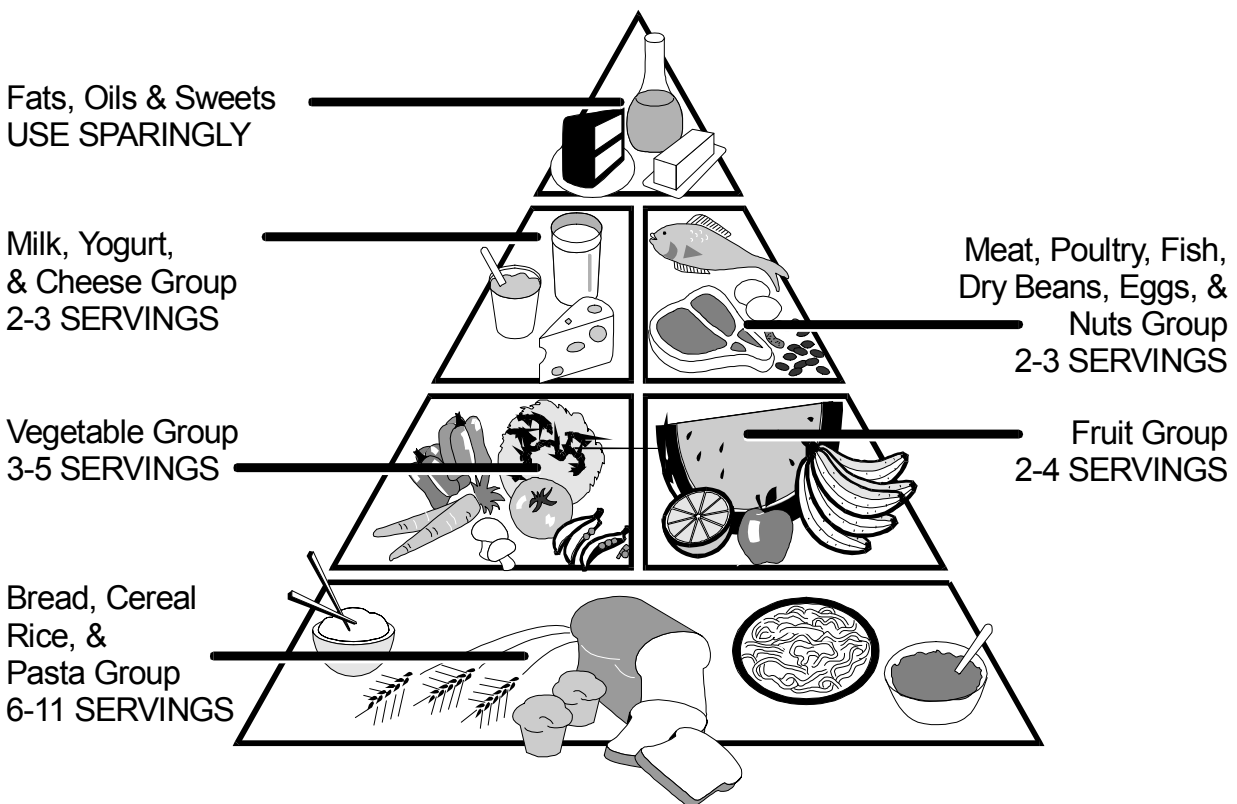

Your body also needs **fiber**, the only form of carbohydrate that is not an energy source. Fiber aids in digestion. It prevents cholesterol, fats, and other toxic materials from entering the bloodstream, and for this reason may lessen your chances of cancer and heart disease. It also helps balance your blood sugar levels, so it helps control **diabetes**. To obtain fiber, eat raw or lightly cooked vegetables, fresh fruit, beans, nuts, and whole wheat or bran breads, cereals, and crackers.

One final nutrient that you do not get from food that is vital to keeping you alive is water. More than 65 percent of the body is water, and, as the body loses water through normal activity and exercise, it must be replaced. Water aids in digestion, regulates temperature, carries vitamins and minerals to all parts of the body, and is important for the removal of waste products from the kidneys. Drink a minimum of six to eight glasses of water a day. On the days you exercise, you may need to drink more.

What Should You Eat In Moderation?

Your body needs fat for energy, but too much fat in your diet can make you gain weight and can lead to high cholesterol. Cholesterol, a type of fat, is a natural, waxy substance produced by your body and found in animal products. Your body needs some cholesterol to remain healthy, but too much is harmful. As illustrated here, cholesterol forms plaque on artery walls, restricting the flow of blood within blood vessels. This leads to high blood pressure and an increased risk of heart disease. In order to lower cholesterol levels, lower your intake of fat by eating less meat, using oil-free dressings, avoiding fried foods, eating low-fat dairy products, and consuming lots of fiber.

Many foods, especially prepackaged foods and restaurant foods, already have added salt; so do not shake on more. Too much salt in your diet forces your body to retain unnecessary water and may contribute to high blood pressure.

Sugary foods such as candy, soda, syrup, and table sugar supply you with calories and few (if any) nutrients. These foods contain “empty calories” – they give your body calories and nothing else. Avoid them while dieting, and do not eat them as a replacement for other foods that provide nutrition. Many fruits and vegetables naturally contain sugar, but they also provide many other important nutrients.

Limit your intake of coffee, tea, and sodas that contain caffeine, a **stimulant**. While caffeine temporarily reduces drowsiness and makes you more alert, in large quantities it can upset your stomach, make you nervous and irritable, keep you awake when you want to sleep, and give you diarrhea.

Did You Know...

- Americans are getting a whopping 27% of their calories from the sugary and fatty foods at the tip of the food pyramid, while most nutritionists think that number should be no more than 5% to 10%.
- One in three Americans gets almost half of his or her calories (45%) from these energy-dense, nutrient poor foods – goodies like candy, sugary soft drinks, potato chips, cookies, cakes, and ice cream (Survey results from a study conducted at Queens College of the City of New York University).
- Americans drank 15 billion gallons of soft drinks in 2000 – twice as much as Americans consumed in the 1970s.

- According to the U.S. Department of Agriculture, young people between the ages of 12 and 19 consume about a half-quart of soda a day or almost a gallon a week.
- According to a study from Harvard School of Public Health, children and adolescent's weight problems were directly proportional to how many soft drinks they consumed.

Every time you reach for a soft drink, you miss an opportunity to eat fruits, vegetables, whole grains, nonfat milk, and other foods that reduce the risk for developing heart disease, cancer, diabetes, stroke, and obesity later in life. One study from Tulane University in New Orleans found that children and teens who ate lots of sugar consumed significantly lower amounts of protein, vitamin E, B vitamins, iron, and zinc. So, consuming too much sugar could be undermining your health today and in the future.

In Addition to Weight Gain, Six More Reasons Not to Drink That Soda

1. Soft drinks steal water from the body much like a diuretic. To replace the water stolen by soft drinks, you need to drink 8-12 glasses of water for every one glass of soft drink that you consume.
2. Soft drinks never quench your thirst, certainly not your body's need for water. Constantly denying your body an adequate amount can lead to chronic cellular dehydration, weakening your body at the cellular level. This, in turn, can lead to a weakened immune system and many diseases.
3. The elevated levels of phosphates in soft drinks leach vital minerals from your body. Soft drinks are made with purified water that also leach vital minerals from your body. A

severe lack of minerals can lead to heart disease (lack of magnesium), osteoporosis (lack of calcium), and many other diseases.

4. Diet soft drinks contain Aspartame, which has been linked to depression, insomnia, neurological disease, and other illnesses. The FDA has received more than 10,000 consumer complaints about Aspartame, that's 80 percent of all complaints about food additives.
5. The high amounts of sugar in soft drinks cause your pancreas to produce an abundance of insulin, which leads to a "sugar crash." Chronic elevation and depletion of sugar and insulin can lead to diabetes and other imbalance related diseases. This can lead to life-long health problems.
6. Soft drinks severely interfere with digestion. Caffeine and high amounts of sugar virtually shut down the digestive process. That means your body is essentially taking in NO nutrients from the food you may have just eaten, even food you ate hours earlier.

Conclusion

Your body needs food for energy, just like a car needs fuel to run. How much food your body needs depends on how active you are and how many calories your body uses to keep its basic functions operating. You know you are getting the right amount of calories from food when you maintain your ideal weight. Not only does food supply you with energy, but the right foods also provide the nutrients your body needs to operate properly and lower your risk of disease. Eating a healthy, balanced diet and exercising regularly increase your chances of a long, strong, and disease-free life. ❖

Nourishing Your Body

PURPOSE

Never before has there been so much information available on nutrition. In fact it is the overwhelming amount of information that often creates confusion. So much of the available information is contradictory. On the same shelf you might find one book that recommends 50% of your calories from fat and another that recommends 10%. Everyone seems to be an expert, and it seems that the experts cannot agree. The truth is that sensational diets sell books. They always have and probably always will. In fact, the experts do agree, at least 99% of them anyway. What follows is a sound nutritional information based on the best recommendation from organizations like the American Heart Association, the American Dietetics Association, and the National Institutes of Health.

Introduction

Nutrition is the science of nourishing the body properly in order to perform at our best.

Our diets have radically changed during the past 35 years. With the advent of fast-food outlets, an increase in dual-career parents, and skyrocketing numbers of single-parent households, most Americans now have a hurry-up lifestyle where proper eating habits take a back seat to convenience and lack of time.

Knowing that our lifestyle is this way, it is very important that young adults have at least a basic understanding of nutrients, how to obtain

them, and how to control fat. This knowledge will lead to a more dynamic life and a higher quality lifestyle. The six types of nutrients are carbohydrates, fats, proteins, vitamins, minerals, and water.

We also refer to the first three nutrients, carbohydrates, fats, and proteins, as foodstuffs. When our body uses the foodstuffs, it releases energy. We measure this energy in **calories**, the amount of energy it takes to raise the temperature of one kilogram of water one degree Celsius. Fats, carbohydrates and proteins are the only nutrients that contain calories, and therefore the only nutrients that give us the energy for all our bodily processes.

There are 3,500 calories in one pound of fat. If you achieve a 3,500-calorie deficit (by reducing your caloric intake) you will lose approximately 1 lb of fat. For example if you reduce your caloric intake by 500 calories per day below maintenance levels, you will achieve a caloric deficit of 3500 per week and should lose approximately 1 lb of fat. On the other hand, if you increase your caloric intake by 500 calories per day above baseline (baseline refers to the number of calories that you need to maintain your bodyweight) you will gain approximately 1 lb of fat per week. It is important to note, however, that these are just approximations. Your metabolism may respond to caloric restriction (reducing calories) by slowing down or to adding calories by speeding up.

The Nutrient: Carbohydrates

Carbohydrates are the starches and sugars found in fruits, grains, and vegetables. They have a caloric value of four calories per gram and supply us with short-term and long-term energy to accomplish

everything from thinking and breathing to running a race.

The short-term carbohydrates are the sugars, or **simple carbohydrates**, that are quickly digested and absorbed into the blood. The most important simple sugar is **glucose**, or blood sugar. Before the body's cells can use other simple sugars (like fructose, sucrose, and lactose) for energy, a change must occur converting them into glucose. Many sugary foods are sources of simple carbohydrates; however, foods like soda and candy have few other nutrients, while fruit is an excellent source of simple carbohydrates and contains many other vitamins and minerals as well.

The long-term carbohydrates are starches, or **complex carbohydrates**, which are made up of combinations of simple sugars. They take longer to digest because the body must break them into simple sugars (glucose) before they can enter the bloodstream. When your body has extra glucose that it does not need right away for energy, it converts it into the complex carbohydrate **glycogen** and stores it in the muscles and liver to be released later when energy is needed, usually for short periods of strenuous activity. Once your muscles and liver store as much glycogen as they can hold, your body changes the rest to body fat for long-term energy. Long distance runners will use carbohydrate loading (eating large quantities of carbohydrates) in order to have the long-term energy they need to complete the race.

Good sources of complex carbohydrates are grains (like bread, cereal, pasta, and rice) and starchy vegetables (like peas, corn, beans, and potatoes). These starchy foods are also important sources of vitamins, minerals, and fiber. Fiber provides no calories but is roughage that aids in the

movement of food through the digestive system.

Nourishing Your Body's Fuel with Fats

Fats, or lipids, perform the vital roles of maintaining body temperature, insulating body organs, providing the body with stored energy, and carrying the fat soluble vitamins A, D, E, and K to the cells. One gram of fat is the equivalent of nine calories of energy, more than twice the amount of carbohydrates. Therefore, minimum consumption of fats is the most sensible approach to maintaining a lean body fat content.

Triglycerides are the primary fats in the foods we eat, as well as the fats stored in body tissue. They include **saturated fat**, which mainly comes from animal sources and does not melt at room temperature, and **mono-unsaturated** and **poly-unsaturated fats**, which are usually liquid oils of vegetable origin. When you eat too many calories, your liver changes them into triglycerides and stores them as fat. When you eat too many saturated fats, your liver makes more cholesterol than your body needs, which is unhealthy.

Your liver already produces about 1000 milligrams (mg) of cholesterol daily and diet adds another 400 to 500 mg. Cholesterol insulates nerves and forms hormones, cell membranes, vitamin D, and bile to aid in food digestion.

Your blood carries cholesterol by way of **lipoproteins**, with low-density lipoproteins (LDL) carrying cholesterol from the liver to the cells to accomplish the functions mentioned. Unfortunately, the LDLs deposit any cholesterol that is not needed by the cells in the arteries, giving them the nickname of the "bad guys". Cholesterol accumulated on the inside walls of the arteries is a factor in the development of atherosclerosis. Eventually, cardiovascular disease, in the form of a heart attack or stroke, may result.

DID YOU KNOW?

Cardiovascular disease is the main killer of Americans.

The **high-density lipoproteins (HDL)** carry the extra cholesterol in your blood to the liver to dispose of it, thus preventing cholesterol from building up in the arteries. For this reason, HDLs are known as the “good guys”. To keep cholesterol at a normal level in the body, you must lower LDL levels and raise HDL levels. Steps you can take to accomplish this are to eat less fat (especially saturated fat), maintain appropriate body weight, and participate in a regular exercise program. Eating more fiber will also help, since it binds with cholesterol and carries it out of the body; and consuming mono-unsaturated fats, like olive, canola, and peanut oils, raises HDLs.

Fat contains nine calories per gram. One pound of fat contains 3500 calories (this is how many calories you must burn to lose 1 lb of fat). Some high fat foods are red meats, fried foods, potato chips, butter, eggs, bacon and many “junk” foods. Try to avoid eating these or at least eat these foods in moderation!

Nourishing Your Body with Proteins

The body contains substances called proteins in every cell. They aid in the development and maintenance of muscle, bone, skin, and blood. Proteins are also the key behind keeping the immune system strong. They control the chemical activities in the body that transport oxygen, iron, and nutrients to the body cells. The body can also use protein for energy if it is low on carbohydrates and fats; but in most cases, its role as an energy source is minor. Proteins, like carbohydrates, contain four calories per gram.

The building blocks of protein are the amino acids. These chains of carbon, hydrogen, oxygen, and nitrogen linked together in different ways control all of the activities mentioned above. There are 22 amino acids found in the human tissue, but the body cannot manufacture all of them. Eight (nine for children) amino acids, known as the

essential amino acids, must come from the food we eat since the body cannot produce them. We refer to the food products that contain all eight essential amino acids as having complete proteins. The best sources of complete proteins are meat, fish, poultry, and dairy products. Plant foods generally contain incomplete proteins since they are either low on or lack an essential amino acid. However, plant foods can be combined easily, like rice and beans or peanut butter and bread, to include all essential amino acids in high enough amounts to form a complete protein.

The remaining 14 amino acids are known as the nonessential amino acids. They are still necessary for bodily functioning, but are called “nonessential” because they do not have to be supplied in the diet. Instead, the body manufactures nonessential amino acids itself.

Keep in mind that while animal and dairy products are sources of complete proteins, many are often high in fat as well. Americans get most of their protein from animal sources instead of from combinations of complex carbohydrates. You will have a healthier diet and still meet your protein needs if you consume fewer fatty foods and more carbohydrates in the forms of grains and vegetables.

The FDA has established the RDA (Recommended Daily Amount) for protein at approximately 50 grams. While it is true that athletes may need slightly higher protein intakes than the RDA, protein intakes as high as 1 gram/pound bodyweight are unnecessary. Excess protein is simply converted to fat. Protein contains 4 calories per gram. Good sources of protein are meats, fish, eggs, dairy products, beans and peanut butter.

Regulating Your Body with Vitamins, Minerals, And Water

Vitamins

Vitamins are promoters of health and wellness. Unlike the carbohydrates, fats, and proteins, the body does not digest vitamins; instead, food products release them and your body tissues absorb them. We classify vitamins as either fat **soluble** or water soluble. With the help of fats, the intestinal tract absorbs fat soluble vitamins (A, D, E, and K) and stores them in the body. The water in the tissues dissolves the water soluble vitamins (B complex and C).

Many countries have standards for vitamin and mineral requirements to recommend daily amounts needed for good health. For example, the standards for the United States are the **Referenced Daily Intakes (RDI)**. From time to time, the federal government reviews these standards and proposes new ones as research continues and more complete information about vitamins and minerals is discovered. Shown on the following pages are the U.S. RDI for vitamins and minerals.

Points of Interest: Vitamins

According to a 10-year study of 11,348 U.S. adults, vitamin C was effective at cutting death rates from heart disease and stroke. The study tested three groups:

- Group 1 got 50 mg or more a day in food, plus an average supplement of 500 mg.
- Group 2 got 50 or more mg and no supplement.
- Group 3 got less than 50 mg with no supplement.
- Men in Group 1 had a 35% lower mortality rate and 42% lower death rate from heart disease and stroke.

- Women in Group 1 were 25% less likely to die of heart disease or stroke and had a 10% lower mortality rate.

Taking supplements of 2000 mg of vitamin C daily might be helpful to allergy sufferers.

A new study found vitamin E cuts the risk of certain cancers. Plus, two other studies with 130,000+ people reported vitamin E helps prevent coronary heart diseases.

Minerals

Minerals are elements found in the environment that help regulate the bodily processes. Without minerals, the body cannot absorb vitamins. Macrominerals are minerals that the body needs in large amounts. These are calcium, phosphorus, magnesium, potassium, sulfur, sodium, and chloride. Although sodium is a macromineral, many Americans consume too much of it, which can contribute to high blood pressure. High blood pressure, in turn, can contribute to cardiovascular disease. On the other hand, many Americans do not consume enough calcium, and a calcium deficiency can lead to osteoporosis later in life.

Use the charts on the next few pages to determine adequate vitamin and mineral doses.

U.S. MARINE CORPS. JROTC
Category 3 – Personal Growth and Responsibility
Skill 2 – Health, Hygiene and Nutrition

VITAMINS			
VITAMIN	U.S. RDI	FUNCTIONS	SOURCES
A	5000 International Units (IU)	Helps maintain eyes, skin, and linings of the nose, mouth, digestive, and urinary tracts	Liver, dairy products, fortified margarine, orange fruits and vegetables, dark-green vegetables
B-1 (Thiamin)	1.5 mg	Helps convert carbohydrates into energy	Yeast, rice, whole-grain and enriched breads/cereals, liver, pork, meat, poultry, eggs, fish, fruits, vegetables
B-2 (Riboflavin)	1.7 mg	Helps convert nutrients into energy; helps maintain skin, mucous membranes, and nervous structures	Dairy products, liver, yeast, fruits, whole-grain and enriched breads/cereals, vegetables, meat, poultry
B-3 (Niacin)	20 mg	Helps convert nutrients into energy; essential for growth; aids in synthesis of hormones	Liver, poultry, fish, milk, eggs, whole-grain and enriched breads/cereals, fruit, vegetables
B-5 (Pantothenic Acid)	10 mg	Helps convert nutrients into energy	Liver, yeast, whole grains, eggs, beans, milk
B-6 (Pyridoxine)	2.0 mg	Aids in more than 60 enzyme reactions	Milk, liver, meat, green, leafy vegetables, whole-grain and enriched breads/cereals
B-7 (Biotin)	0.3 mg	Helps convert nutrients to energy	Liver, yeast, milk, oatmeal, beans, nuts, egg yolk
B-9 (Folic Acid)	0.4 mg	Aids in blood cell production; helps maintain nervous system	Liver, green, leafy vegetables, beans
B-12 (Cobalmin)	6 micrograms (mcg)	Helps form new cells	Meat, seafood, poultry, dairy products, eggs
C	60 mg	Helps maintain and repair connective tissue, bones, teeth, cartilage; promotes wound-healing	Broccoli, brussels sprouts, citrus fruit, tomatoes, potatoes, peppers, cabbage, other fruits and vegetables
D	400 IU	Helps regulate calcium and phosphorus metabolism; promotes calcium absorption; essential for development/maintenance of bones and teeth	Fortified milk, eggs, fish-liver oils, sunlight on skin
E	30 IU	An antioxidant (prevents oxygen from interacting destructively with other substances) that helps protect cell membranes, maintain fats and vitamin A, and increase blood flow	Green, leafy vegetables, whole grains, seeds, nuts, vegetable oil/shortening, liver, egg yolks
K	60 – 80 mcg*	Helps in blood clotting	Green, leafy vegetables, liver, tomatoes, egg yolks, milk

* No U.S. RDI established. Amount is an estimated recommendation for dietary intake.

U.S. MARINE CORPS. JROTC
Category 3 – Personal Growth and Responsibility
Skill 2 – Health, Hygiene and Nutrition

Although the body only needs trace minerals (such as selenium, manganese, molybdenum, iron, copper, zinc, iodine, and chromium) in very small amounts, they are also essential for proper functioning of the body. For example, an iron deficiency can reduce the number and size of red blood cells – causing weakness, sleepiness, and headaches.

Point of Interest: Minerals

A study has found that heart-disease patients who received 150 mcg of chromium per day had a dramatic jump in the HDL cholesterol, the “good” cholesterol that helps keep arteries clear.

Water

About 60 to 70 percent of your body is water, with most of your blood, brain, and muscles being water and even 20 percent of your bones. Water carries the other nutrients, when dissolved, to all parts of the body where and when needed. It also aids in digestion, regulation of temperature, removal of wastes, joint lubrication, and biochemical processes taking place in the body all the time. Without water you would die in a few days. To maintain all the bodily functions water helps carry out, you need to consume the equivalent of six to eight glasses of water a day. If you exercise regularly, you may need as many as ten glasses, especially on the days you exercise.

MACROMINERALS			
MINERAL	U.S. RDI	FUNCTIONS	SOURCES
Calcium	1000 mg	Structure of bones and teeth; muscle contraction; maintenance of cell membranes; blood clotting; nerve impulse transmission; heart activity	Dairy products, small fish (like sardines) with bones, dark-green vegetables, dried beans and peas
Phosphorus	1000 mg	Structure of bones and teeth; release of energy from nutrients; formation of enzymes	Meat, poultry, fish, eggs, dried beans and peas, dairy products
Magnesium	400 mg	Building bones; release of energy from muscle glycogen; conduction of nerve impulse to muscle	Green, leafy vegetables, nuts, soybeans, seeds, whole grains
Potassium	3500 mg*	Muscle contraction; maintenance of fluid and electrolyte balance; transmission of nerve impulse; release of energy from nutrients	Orange juice, bananas, dried fruit, meat, bran, peanut butter, potatoes, coffee, tea, cocoa
Sulfur	140 mg*	Part of sulfur-containing amino acids; firm proteins of hair, nails, and skin	Meat, wheat germ, dried beans and peas, peanuts
Chloride and Sodium	No more than 2400 mg*	Regulate blood and fluids; nerve impulse transmission; heart activity; metabolic controls	Table salt (sodium chloride), many canned soups and processed foods, pickles, soy sauce, sauerkraut, celery
* No U.S. RDI established. Amount is an estimated recommendation for dietary intake.			

U.S. MARINE CORPS. JROTC
 Category 3 – Personal Growth and Responsibility
 Skill 2 – Health, Hygiene and Nutrition

TRACE MINERALS			
MINERAL	U.S. RDI	FUNCTIONS	SOURCES
Selenium	50 – 75 mcg*	Prevent breakdown of fats	Seafood, whole-grain cereals, meat, egg yolk, milk, garlic
Manganese	5 mg*	Central nervous system; normal bone structure; reproduction	Nuts, whole grains, vegetables, fruits, tea, cocoa powder
Fluoride	1.5 to 4 mg*	Tooth and bone formation	Drinking water in some places, seafood, tea
Molybdenum	75 – 250 mcg*	Part of enzymes	Legumes, cereals, liver, kidneys, dark-green vegetables
Iron	18 mg	Formation of hemoglobin; part of enzymes and proteins	Liver, kidneys, meat, egg yolk, green, leafy vegetables, dried fruit, dried beans and peas, whole-grain and enriched cereals
Copper	2 mg	Formation of red blood cells; part of respiratory enzymes	Oysters, nuts, cocoa powder, liver, kidneys, beans, corn oil, margarine
Iodine	150 mcg	Functioning of the thyroid gland and production of thyroid hormones	Iodized salt, seafood
Chromium	50 – 200 mcg*	Helps the body use carbohydrates and fats; aids in digestion of protein	Liver, nuts, whole grains, Brewer's yeast, meat, mushrooms, potatoes, apples with skin, oysters
Zinc	15 mg	Part of many enzymes; essential to synthesis of DNA and RNA; metabolize carbohydrates, fats, and proteins; dispose of carbon dioxide; strengthen immune system; helps wounds heal; helps body use vitamin A	Meat, liver, eggs, poultry, seafood

* No U.S. RDI established. Amount is an estimated recommendation for dietary intake.

Your Nutrition Prescription

Vitamin and mineral supplements are indispensable anti-aging weapons, but too many people use them shotgun style instead of coordinating them for the most life-lengthening strategy. To ensure that you are not over- or under-doing any element, you need a prescription customized for your age, gender, health, and lifestyle – just what the six questions below will give you.

For each “yes” answer, follow the directions for revising the supplement blueprint in the right column. If you end up with more than one recommendation for a particular nutrient, follow the highest single dosage.

- *Are you male?* Delete iron.
- *Do you smoke or live/work with a smoker, or do you live in an air-polluted area?* Increase C to 1000 mg, selenium to 400 mcg, beta-carotene to 25000 IU, E to 400 IU, copper to 3 mg, and zinc to 50 mg.
- *Do you exercise at least three times a week for 20 or more minutes?* Increase E to 400 IU, magnesium to 400 mg, B-1 to 100 mg, and zinc to 50 mg.
- *Are you on the Pill?* Increase B-6 to 50 mg.
- *Are you pregnant or nursing?* Increase folic acid to 800 mcg, iron to 60 mg, calcium to 1300 mg, and magnesium to 400 mg. Delete A.
- *Do you have high cholesterol levels and/or a family history of heart disease?* Increase E to 400 IU, C to 1000 mg, beta-carotene to 25000 IU, chromium to 200 mcg, and magnesium to 400 mg.

According to Ronald Hoffman, MD, Director of the Center for Holistic Medicine in New York City, supplements are especially important for people who do not eat 1) fresh fruits and vegetables daily; 2) dairy products more

than once a week; or 3) at least two full meals a day. Some of the above recommendations are higher than the U.S. RDI's because longevity research has leapfrogged over the old standards. However, all recommendations are well within safety guidelines. Avoid taking more than the amounts suggested; megadosing can be dangerous. Remember, check with your doctor before starting any supplement regimen.

PERSONAL SUPPLEMENT BLUEPRINT

<u>Supplement</u>	<u>Longevity Standard</u>	<u>Dose</u>
Beta-carotene	15,000 IU	_____
Vitamin A	10,000 IU	_____
Vitamin B-1	25 mg	_____
Vitamin B-2	25 mg	_____
Niacinamide	100 mg	_____
Pantothenic acid	50 mg	_____
Vitamin B-6	25 mg	_____
Vitamin B-12	100 mcg	_____
Biotin	100 mcg	_____
Folic acid	400 mcg	_____
Vitamin C	500 mg	_____
Vitamin D	400 IU	_____
Vitamin E	200 IU	_____
Calcium	1,200 mg	_____
Chromium	100 mcg	_____
Copper	2 mg	_____
Iodine	150 mcg	_____
Iron*	18 mg	_____
Magnesium	200 mg	_____
Manganese	5 mg	_____
Molybdenum	50 mcg	_____
Selenium	200 mg	_____
Zinc	30 mg	_____

**Double-check with your doctor before adding iron to your regimen. Some people are prone to iron overload.*

The Road to Fat Control

A 1992 Consumer Reports survey with 68 nutrition experts indicated a deepening concern over America's dietary habits and implicated the leading causes of death as being associated with eating and drinking. They are coronary artery disease (heart attack), cancer, cerebral vascular disease (stroke), diabetes, liver disease, plus bowel disorders, and osteoporosis.

The 68 experts agreed that Americans should follow the dietary guidelines set forth by the U.S. RDI and the Department of Health and Human Services. Additionally, the experts were much more deliberate in defining an "ideal" diet as one which maximizes the immune system, reduces the risk of disease, and minimizes the process of aging.

By understanding the experts' opinions and responses, we can develop a formula that promotes a healthier lifestyle. If used properly, this formula can improve your immune system and reduce the risks of the leading causes of death. It can also keep your body fat at a healthy level, and enhance your potential to maintain an ideal body fat content for life.

Carbohydrates: How to Eat Them

A definition of natural foods is one that fits the carbohydrate category perfectly. The definition says natural foods are foods that are as unrefined as possible and free from additives and preservatives. Fruits, vegetables, and grains in their natural state are the key elements to a maximized immune system and a body fat content that will maintain itself for a lifetime.

There is growing evidence that a diet rich in fruits, vegetables, and grains will reduce the risk of certain cancers. Such a diet will also protect the heart and bones from early breakdown and

infirmity, which limit millions of Americans from enjoying their potential.

The experts recommend at least seven servings of fruits and vegetables and six servings of grain products a day. Because of our hurry-up lifestyles, this may not be possible. However, evidence supports eating small amounts of these natural products several times a day for maximum benefit.

If you can consume 60 to 80 percent of your calories from the carbohydrate group, you will be able to control your body fat much more easily. There are two main reasons why this is so important. There are only four calories per gram in carbohydrates and, in order to store carbohydrate as storage fat, it takes 23 calories out of each 100 calories eaten. That means you can consume more food and still maintain a lean body fat content.

This dieting regimen will enable you to receive all the fiber you need (20 to 35 grams a day) without worrying about supplemental fiber. Plus, there is also room to enjoy a sweet treat. But remember, look at the label and keep the fat content for the sweet to nearly zero.

Protein: Don't Worry

If you are eating the recommended amounts of carbohydrates in a diversified manner, tests indicate you will receive your complete protein needs without concern. Most of your protein (about 85 to 90 percent) should come from plant sources, or the complex carbohydrates. Studies indicate that populations eating a high degree of protein coming from animal products (as are the Americans with 70 to 75 percent) will have a higher incidence of health problems.

Fat: The Culprit

A typical American diet contains 35 to 40 percent fat intake per day. Of that, saturated fat is about 10 to 15 percent. Minimizing the intake of saturated fat lowers the LDL (“bad” cholesterol) levels, making it advisable to cut down on saturated fat to five to seven percent of total daily fat intake. Overall, total fat intake should preferably be no more than 20 percent of your total caloric intake per day. This regimen will not only aid in the improvement of your complete health profile, but it will help you to maintain a minimal body fat content.

Vitamins, Minerals, and Water: The Regulators

In general, the experts believe that you can receive your vitamins and minerals in sufficient amounts from a well-balanced diet. They also suggest that you drink water at a rate of six to eight glasses per day – more if you work out rigorously.

Understanding the Nutrition Facts Panel on food Labels

Now that you have all this valuable information, how can you make good choices in the foods you eat – especially foods that are already prepackaged.

Have you ever noticed the Nutrition Facts labels on prepackaged foods in the supermarket? Most of the information may seem confusing, too technical, or perhaps more than you thought you wanted to know. The following information will help you use this information more effectively and easily. Knowing what the information means will make it easier for you to use nutrition labels to make quick, informed food choices that contribute to a healthy diet.

Sample Label for Macaroni and Cheese

Nutrition Facts			
Serving Size: 1 cup (228g)			
Servings Per Container: 2			
<hr/>			
Amount Per Serving			
Calories	250	Calories from fat 110	
<hr/>			
			% Daily Value*
Total Fat	12g		18%
	Saturated Fat 3g		15%
Cholesterol	30mg		10%
Sodium	470mg		20%
Total Carbohydrate	31g		10%
	Sugars 5g		
	Dietary Fiber 0g		0%
Protein	5g		
<hr/>			
Vitamin A			4%
Vitamin C			2%
Calcium			20%
Iron			4%
* Percent (%) of a Daily Value is based on a 2000 calorie diet. Your Daily Values may vary higher or lower depending on your calorie needs:			
		2000	2500
Nutrient		Calories	Calories
Total Fat	Less than	65g	80g
Sat Fat	Less than	20g	25g
Cholesterol	Less than	300mg	300mg
Sodium	Less than	2400mg	2400mg
<hr/>			
Total Carbohydrate		300g	375g
	Dietary Fiber	25g	30g

Two Parts to the Panel

There are two parts to the Nutrition Facts Panel.

- The main or top section contains product-specific information that varies with each food product.

- The bottom part contains a footnote. This footnote is only on larger packages and provides general dietary information about important nutrients.

Serving Size

The first place to start when you look at the Nutrition Facts panel is the serving size and the number of servings in the package. Serving sizes are provided in familiar units, such as cups or pieces, followed by the metric amount, e.g., the number of grams. Serving sizes are based on the amount of food people typically eat, which makes them realistic and easy to compare to similar foods.

Nutrition Facts
Serving Size: 1/2 cup (114g)
Servings Per Container: 4

Pay attention to the serving size, including how many servings there are in the food package, and compare it to how much you actually eat. The size of the serving on the food package influences all the nutrient amounts listed on the top part of the label. In the sample label on the previous page, one serving of macaroni and cheese equals one cup. If you ate the whole package, you would eat TWO cups. That doubles the calories and other nutrient numbers, including the %Daily Values.

Calories and Calories from Fat

Calories provide a measure of how much energy you get from a serving of this food. The label also tells you how many of the calories in one serving come from fat. In the example, there are 250 calories in a serving of this macaroni and cheese. How many *calories from fat* are there in ONE serving? Actually, 110 calories come from fat, which means almost half come from fat. What if you ate the whole package content? Then, you

would consume two servings, or 500 calories, and 220 would come from fat.

Amount Per Serving	
Calories 250	Calories from fat 110

The Nutrients

Limit These

The nutrients listed first are the ones Americans generally eat in adequate amounts, or even too much. They are located on the label immediately after the serving size information. Eating too much fat or too much sodium may increase your risk of certain chronic diseases, like heart disease, some cancers, or high blood pressure. Eating too many calories is linked to overweight and obesity.

Total Fat 12g	18%
Saturated Fat 3g	15%
Cholesterol 30mg	10%
Sodium 470mg	20%

Get Enough of These

Americans often don't get enough dietary fiber, vitamin A, vitamin C, calcium, and iron in their diets. Eating enough of these nutrients can improve your health and help reduce the risk of some diseases and conditions. For example, getting enough calcium can reduce the risk of osteoporosis, in which bones become brittle and break as a person ages.

Dietary Fiber 0g	0%
------------------	----

Vitamin A	4%
Vitamin C	2%
Calcium	20%
Iron	4%

The Percent Daily Value (%DV)

18%
15%
10%
20%
10%
0%
4%
2%
20%
4%

This part of the Nutrition Facts panel tells you whether the nutrients (fat, sodium, fiber, etc) in a serving of food contribute a lot or a little to your total daily diet. By diet we mean all the different foods you eat in a day.

Percent Daily Values are based on recommendations for a 2,000-calorie diet. For labeling purposes, FDA set 2,000 calories as the reference amount for calculating %DVs. The %DV shows you the percent (or how much) of the recommended daily amount of a nutrient is in a serving of food.

By using the %DV, you can tell if this amount is high or low. You, like most people, may not know how many calories you consume in a day. But you can still use the %DV as a frame of reference, whether or not you eat more or less than 2,000 calories each day.

It's not hard to follow nutrition experts' advice for a healthy diet. Try to limit your total daily intake of fat, saturated fat, sodium, and cholesterol to less than 100%DV.

Likewise, you should try to average 100% of essential nutrients like calcium, iron, and vitamins A and C as well as dietary fiber.

* Percent (%) of a Daily Value is based on a 2000-calorie diet. Your Daily Values may vary higher or lower depending on your calorie needs:			
		2000	2500
Nutrient		Calories	Calories
Total Fat	Less than	65g	80g
Sat Fat	Less than	20g	25g
Cholesterol	Less than	300mg	300mg
Sodium	Less than	2400mg	2400mg
Total Carbohydrate		300g	375g
Dietary Fiber		25g	30g

%DVs Are Easy to Use

Do you need to know how to calculate percentages to follow this advice? If not, the label (the %DV) does the math for you. It helps you interpret the numbers (grams and milligrams) by putting them all on the same scale (0-100%DV), much like a ruler. This way you can tell high from low and know which nutrients contribute a lot, or a little, to your daily recommended allowance.

Example of %DV for Total Fat

If you cover up the %DVs on the sample label, can you tell if 12g of Total Fat is high or low? Another way of asking this question is, does one serving (containing 12g of fat) contribute a lot or a little Total Fat to your daily diet?

Now look at the %DVs on the label example: 12g fat equals 18%DV. When one serving of macaroni and cheese contains 18%DV for Total Fat, that means you have 82% of your fat allowance left for all the other foods you eat that day (100%-18%=82%).

Sugars and Protein

Look back at the sample label and notice that neither Sugars nor Protein lists a %DV on the Nutrition Facts panel.

Sugars

No daily reference value has been established because no recommendations have been made for the total amount of sugars to eat in a day. Keep in mind, the sugars listed on the Nutrition Facts panel include naturally occurring sugars (like those in fruit and milk) as well as those added to a food or drink. Check the ingredient list for specifics on added sugars.

Protein

A %DV is required to be listed if a claim is made for protein, such as “high in protein”. Otherwise, unless the food is sold for infants and children under 4 years old, none is needed. Current scientific evidence indicates that protein intake is not a public health concern for adults and children over 4 years of age.

The Footnote or Lower Part of the Panel

* Percent (%) of a Daily Value is based on a 2000 calorie diet. Your Daily Values may vary higher or lower depending on your calorie needs:			
		2000	2500
Nutrient		Calories	Calories
Total Fat	Less than	65g	80g
Sat Fat	Less than	20g	25g
Cholesterol	Less than	300mg	300mg
Sodium	Less than	2400mg	2400mg
Total Carbohydrate		300g	375g
Dietary Fiber		25g	30g

Note the “*” used after the heading “%Daily Value” on the Nutrition Facts panel. It refers to the Footnote in the lower part of the nutrition label, which tells you that “%DVs are based on recommendations for a 2,000 calorie diet”. This statement must be on all food labels. However, the remaining information in the full footnote may not be on the package if the size of the label is too small. When the full footnote does appear, it will always be the same. It does not change from product to product because it shows dietary advice for all Americans – it is not about a specific food product.

The Daily Values are based on expert dietary advice about how much, or how little, of some key nutrients you should eat each day,

depending on whether you eat 2,000 or 2,500 calories a day.

Example: look at the Total Fat information in the footnote. It tells you that if you eat a 2,000-calorie diet, you should eat *less than 65g of fat in all the foods* you eat in a day. By doing this, you will follow nutrition experts’ advice to consume no more than 30 percent of your daily calories from fat. Because the DV for total fat is “less than 65g,” this is the same thing as saying, to keep your Total Fat intake for the day below 100%DV.

If you consume 2,500 calories per day, the Footnote shows you how your daily values would change for some nutrients but not for others. The Daily Values for Cholesterol (300mg) and Sodium (2,400mg sodium) remain the same no matter how many calories you eat. But recommended levels of intake for other nutrients do depend on how many calories you consume.

Note: The content on the Nutrition Facts Panel comes from the U.S. Food and Drug Administration, Center for Food Safety and Applied Nutrition website, June 2000.

Nutrition and Athletic Performance

There is a great deal of evidence showing a relationship between the amount and kinds of food you eat and your athletic performance. A poor diet will most likely have an adverse effect on the performance of even the most casual athlete. A good diet providing adequate calories, vitamins, minerals, and protein helps provide the energy you need to finish a race or simply enjoy a recreational sport or activity.

Recommendations

There is little difference between the diet recommended for an athlete and the diet suggested for any healthy individual. The Food Guide Pyramid is an excellent guide. Recall that it recommends eating a liberal amount of complex carbohydrates, only a moderate amount of protein, and limited amounts of fats and refined sugars. Calorie needs vary with a person's size, age, sex, and amount of physical activity so the number of servings a person should eat varies.

Carbohydrates

Complex carbohydrates are the staple of every diet. They are found in foods such as pasta, bagels, whole grain breads, and rice. They provide energy, fiber, vitamins, and minerals and are low in fat. Carbohydrate loading (a diet/training regimen) will increase your body's energy stores of carbohydrates (called glycogen). You will see a definite improvement in endurance-type activities lasting more than 1 hour when you load up on carbohydrates. You should consume 50% to 60% of your calories from carbohydrates on a daily basis. Include complex carbohydrates (starches) and naturally occurring sugars rather than processed or refined sugars in your diet. These are the preferred complex carbohydrates you should consume.

Simple sugars such as soft drinks, jams and jellies, and candy provide few nutrients but a lot of calories. They may actually decrease performance when consumed directly before an athletic event as they may cause **hypoglycemia**.

Protein

Protein's most important functions in the body is to support growth and to repair body tissues. Although many researchers have proven the idea false, many people still believe that

athletes need a high protein diet to support muscle growth. A high protein diet does not promote muscle growth. Only strength training and exercise will promote changes in muscle. Athletes, even body builders, require only small increases in the amount of protein they eat in order to support muscle growth. Just by consuming more total calories (eating more food), athletes can easily meet this increased need. Americans already eat more protein than they need. Studies have shown that Americans tend to eat twice as much protein as necessary. Americans' protein needs for muscle development are being met before strength training begins. The body either uses or stores as fat any protein above what you need. Amino acid supplements and excessively high intakes of protein are not recommended. They can increase calcium loss, and put an added burden on the kidneys, which are required to filter the excess nitrogen protein provides.

Water and Fluid

Water is the most important, yet often forgotten, nutrient that athletes must consider in order to achieve peak performance. Water and fluids are essential to maintaining good hydration and body temperature. When you sweat to keep your body cool, you can lose in excess of several liters in a 1-hour period. Both adolescents and adults need to replace any lost body weight lost during exercise with equal amounts of fluids. A good indication that you have fully **rehydrated** is to check to see if your urine is clear. Drinking cool water is the best choice to rehydrate your body.

Some suggestions for maintaining adequate hydration are:

- Drink plenty of water, juice and milk.
- Avoid beverages that contain caffeine. Caffeine is a diuretic and promotes fluid loss.

- Drink plenty of fluid before, during, and after exercise.
- Offer children water frequently during sports activities; they do not respond to thirst as readily as adults.

Achieving Desired Weights for Competitive Purposes

An athlete or anyone who attempts to change his/her body weight to improve athletic performance must do so, safely and effectively or it may do more harm than good. Trying to maintain an unrealistically low body weight, attempting to lose weight rapidly, and unnaturally suppressing weight gain can have negative health effects. It is very important to set realistic body weight goals. Young athletes attempting to lose weight may benefit from a consultation with a Registered Dietitian. Eating disorders and poor dietary habits may be the result of experimenting with diets. The Food Guide Pyramid is an excellent resource to ensure adequate food intake to meet vitamin and mineral needs while safely achieving body composition goals.

Conclusion

The science of nourishing the body properly is a continually revolving door of facts, information, and misleading information. Much of the data is very conflicting and difficult to sort out, although there is some material that has remained consistent throughout the years. A basic understanding of this information will enable you to stay properly nourished.

To begin building a healthy diet, the Dietary Guidelines of Americans provides the following advice:

- Eat a variety of foods to obtain the energy, proteins, vitamins, minerals, and fiber you need for good health.
- Maintain a healthy weight to reduce your chances of having high blood pressure, heart disease, a stroke, certain cancers, and the most common kind of diabetes.
- Choose a diet low in fat, saturated fat, and cholesterol. Because fat contains over twice the calories of an equal amount of carbohydrates or protein, a diet low in fat can help you to maintain a healthy weight.
- Choose a diet with plenty of vegetables, fruit, and grain products that provide the needed vitamins, minerals, fiber, and complex carbohydrates, and can help you to lower your intake of fat.
- Use sugars only in moderation. A diet with lots of sugars has too many calories and too few nutrients for most people.
- Use salt and sodium only in moderation.
- Avoid drinking alcoholic beverages. Although alcoholic beverages supply calories, they have little or no nutrients. Furthermore, drinking alcohol is the cause of many health problems and accidents. ❖

Practicing Good Manners

PURPOSE

The first impressions people have of us are often based on what we wear and how we wear it; manners and speech are noted after that, and character is noticed last of all. Character is the fundamental quality that is most important in our society. Although personality also assists us in making a good impression, perhaps the attributes that are most critical overall are good manners and a pleasing appearance.

*Good manners are nothing but courteous and sincere **consideration** of other people's interests and feelings. Dressing appropriately for an occasion reflects your good manners and makes a positive impression on those around you. The guidelines presented here are proper, whether you are in the civilian or military community. Good manners and appropriate dress are always appreciated.*

Introduction

Social **etiquette**, social standards, **protocol**, rules of behavior, proper **manners** and dress – do not let these terms scare you or turn you off. In the military and civilian world, various events and occasions require certain social standards and procedures to follow. But this is not just another list of what you “have to do” or “must do”. Social etiquette and protocol is nothing more than common courtesy, sincerity and consideration for others. It is important to treat others in the same way we wish others to

treat us. Using good manners with others invites others to treat us in the same way – with consideration for our interests and feelings. Consideration for the rights and feelings of others is not merely a rule for behavior in public but the very foundation upon which social life is built.

General Consideration of Others

The following list demonstrates proper manners in different situations:

- Listening attentively when someone speaks to you is one of the most basic rules of etiquette. The person who, while some one is talking to him, gazes out of the window or up at the ceiling, who draws squares and circles on a notepad, or is engrossed in his fingernails or his shoes, is extraordinarily rude!
- For both the salesperson and the customer, it is only appropriate to be well mannered and polite.
- A gentleman, whether walking with two ladies or one, always takes the curb side of the pavement.
- When you are on the street, or anywhere in public, be careful not to talk too loudly. Do not attract attention to yourself in public. Do not expose your private affairs, feelings or innermost thoughts to everyone around you.
- If an older woman or an invalid gentleman wants some support, offer your arm to help. Otherwise, a woman does not lean on a man's arm in the daytime, unless to cross a very crowded street or to be helped over a rough piece of road. The only occasions when a man

offers his arm to a woman are in taking her in at a formal dinner, or taking her in to supper at a ball, or when he is an usher at a wedding.

- Never take more than your share—that includes your share of the road in driving a car, or chairs on a boat, or seats on a train, or food at the table.
- People who picnic along the highway and leave greasy papers and garbage for other people to walk or drive past, are demonstrating their lack of good manners and lack of consideration for others.

Making Introductions

A person's name is his or her most personal possession; therefore, it is thoughtful to pronounce names clearly during introductions. To avoid awkward silences where no one seems to know quite what to say to a stranger, say something interesting about the person being introduced. For example, you might introduce your friend by saying, "Sarah, have you met Bob? He is the stage manager this year for all our school's drama productions."

When introducing a man and a woman, the woman's name is always first. For example, "Amanda, have you met Mike?" The exception would be if she is meeting the President, a king, a dignitary of the church, or a senior male Marine who is meeting a junior woman Marine, for example, "Sergeant Major Aldridge, I'd like to introduce Sergeant Megan Ross."

When introducing a person with a title, traditionally, the name of the honored person at an event is given first, however, very few people are introduced by their formal titles. A doctor, a judge, a bishop, are addressed and introduced by their titles. The clergy are usually Mister unless

they formally hold the title of Doctor, or Dean, or Canon. A Catholic priest is "Father Kelly." A senator is always introduced as Senator, whether he is still in office or not. But the President of the United States, once he is out of office, is merely "Mr." and not "Ex-president."

When introducing older adults to those who are younger, the older adult's name is given first, for example, "Grandmother, this is my friend Jake Morris." The exception to this rule would be if he or she is meeting an honored or high ranking individual. For example, you would say, "General Thomas, I'd like to introduce you to my mother, Joan Kelly."

Introduce individuals to a group by saying, "Everyone, please welcome Samantha Davis."

Of course, the easiest introduction is often, "Nancy, Bert."

Gentlemen always stand when being introduced. Women may stand if they wish. It is always proper to stand when meeting older women, dignitaries and senior Marines or other senior members of the military.

If there is no one to make introductions, introduce yourself! "Hi, I'm Dan Phillips." (That was easy, wasn't it?)

When being introduced, take the time to listen and, if you are not certain you heard the name correctly, ask that the name be repeated. Calling a new acquaintance by name not only helps you remember the name, but also is flattering to the person to whom you are being introduced.

When you are introduced to someone you have previously met, and there is the possibility that the person may not remember you, state your name and remind the individual where you may

have met before. For example, you might say, “Mr. Heins, we met at the bluegrass concert last September. I was there with your daughter, Nicole, and her friend, Kate.”

When making an introduction, do not panic if you can't remember the rules of introductions. It is much better to use the wrong procedure for an introduction than to hesitate and miss an opportunity to begin a new friendship.

When to Shake Hands

When men are introduced to each other, they always shake hands. When a man is introduced to a woman, she sometimes puts out her hand. Strictly speaking, it is always the woman's place to offer her hand or not as she chooses, but if the man puts out his hand, it is rude on her part to ignore it.

The traditional American handshake is made briefly, but there should be a feeling of strength and warmth in the clasp. Please, no limp handshakes! At the same time, you should look at the person whose hand you are shaking.

How to Leave after Meeting Someone

After an introduction, when you have talked for some time, it is polite to say, “Good-bye, I am very glad to have met you,” or “Good-bye, I hope I will see you again soon”. The other person answers, “Thank you,” or perhaps adds, “I hope so, too.” Usually “Thank you” is all that is necessary.

Informal Greetings

In informal greetings you can say, “Good morning” and on occasions “How are you?” or “Good evening.” On very informal occasions, it is appropriate to greet a close friend with “Hello!” The “Hello” is spoken, not called out. There are only two forms of farewell: “Good-bye” and “Good night.”

Very often in place of the over-worn and over-used “How do you do?,” people skip the words of actual greeting and plunge right into conversation: “Why, Mary! When did you get back from your vacation?” or “What is new with you?” or “What have you been doing lately?” The weather, too, is often the beginning of a conversation.

Conversation

Good conversation is a plus in any social occasion, but often we are uncertain what to say. The best topics of conversation are ideas, then places and events. The topic to avoid is gossip about people, of course.

Being a good listener is just as important as being a good **conversationalist**. Here are four key guidelines to remember:

- Show an interest in other people.
- Avoid bringing up or discussing controversial topics.
- Listen and learn.
- Ask questions and make the other person feel important.

Appropriate Dress

Clothes appropriate to the occasion are the first **requisite** of good taste. In the case of

what to wear, many times an invitation will specify appropriate dress. If you have any doubts, always ask the hostess.

Here are some dress terms that you often find on invitations, and what they mean.

- Very casual – Ladies and men wear slacks, shorts or jeans.
- Casual – Ladies wear a sporty dress, skirt and blouse, or dress slacks (no jeans). Men wear open-collar shirts; a sport coat is optional.
- Informal or Civilian Informal – Ladies wear a dressy dress (for example, a dress you might wear to church) or a suit. Men wear a suit or coat and tie.
- Formal – Guests: Ladies wear long or short formal dress. Men wear black tie. Military are required to wear the designated uniform.

Women perhaps focus more on dress. Here is some good advice. A dinner dress really means every sort of low-necked, or half low-necked evening dress. A formal dinner dress, like a ball dress, is typically low-necked and without sleeves. The perfect ball dress is one purposely designed with a skirt that is becoming when dancing. A long wrapped type of dress might be dignified and beautiful at a dinner, but a ball dress is designed for freedom of movement.

The informal dinner dress is worn to the theater, a very formal (high class) restaurant, the concert, and the opera.

When in Doubt

For a woman, there is one more rule that is fairly safe to follow: When in doubt, wear the plainer dress. It is always far better to be under-dressed rather than over-dressed. If you do not know or are unsure whether to put on a ball dress or a dinner dress, wear the dinner dress.

Correspondence - Invitations, Acceptances and Regrets

Your **correspondence**, whether for formal or informal occasions, is a reflection of you. Therefore, your choice of stationery, writing style and spelling (including the correct spelling of names) is most important. In conversation, you are judged by what you say; in correspondence, you are judged by what you write.

Informal Correspondence

Fold-over informal notes such as thank-you notes, invitations and all-occasion correspondence are always correct. Fold-over “informals” are about 3 by 4 inches in size. You might have seen a friend or relative about to graduate high school or college with these size notes, engraved or embossed with their full name on white or cream colored, fine quality paper. These are the notes that he or she might use to write and thank a relative or friend for a graduation gift. You can find this size note – and even have it engraved with your name – at any good stationery store.

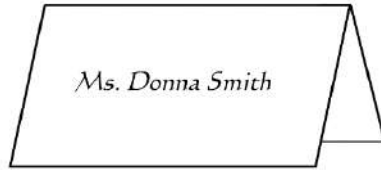

Outside

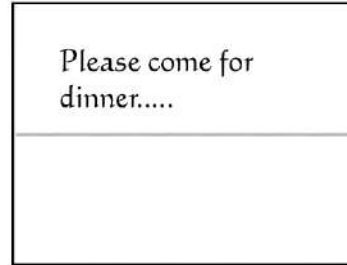

Inside

Invitations

When writing an invitation, it is important to include all **pertinent** information, such as the type of event; who is giving the event; the place, date and time of the event; and a telephone number and/or address where regrets and acceptances should be sent. It is a good idea to also include a small map and/or written directions.

If you are sending out invitations – either formal or informal – you should send them out 10 to 14 days in advance of the event.

Formal Invitations

Formal invitations may be fully engraved, partially engraved, or written in longhand with black ink using the same format as a fully engraved invitation.



Informal Invitations

Informal invitations may be extended in person, by telephone, handwritten note, informal card, or commercially printed invitation. “Handmade” invitations are also appropriate.

Envelopes for most social correspondence are handwritten (unless the contents are typewritten). The return address is handwritten either in the upper left-hand corner or centered on the back flap of the envelope.

Example of an Informal Invitation



R.S.V.P.

Do you know why the letters “**R.S.V.P.**” are in the left-hand corner of an invitation? R.S.V.P. is an abbreviation for the French phrase, “*Repondez s’il vous plait*,” which simply means, “please reply.” In order to avoid confusion – and to ensure that people will respond to your invitation (hopefully) - you may want to instead write “Please Reply” on your invitations.

If you receive an invitation from someone, please respond to an R.S.V.P. and let the person know who has invited you whether or not you will be able to attend. It is your

responsibility to reply to an invitation. Replying is a sign of your good manners and is the considerate thing to do!

If you have accepted an invitation and find that you will be unable to attend, let the person who invited you know immediately!

If an invitation has “R.S.V.P Regrets Only,” an answer is required only if you are unable to attend.

Even though an invitation may not have an R.S.V.P., it is always thoughtful to call and thank the person for inviting you and let that person know whether or not you can come.

If you wish to bring a friend with you to an event and the invitation does not specifically indicate that you may bring a guest with you, please remember that it is rude to show up to any

people giving the event well), and if they indicate that is not possible (perhaps it is for a sit-down dinner for only a certain number of people), you must abide by their decision.

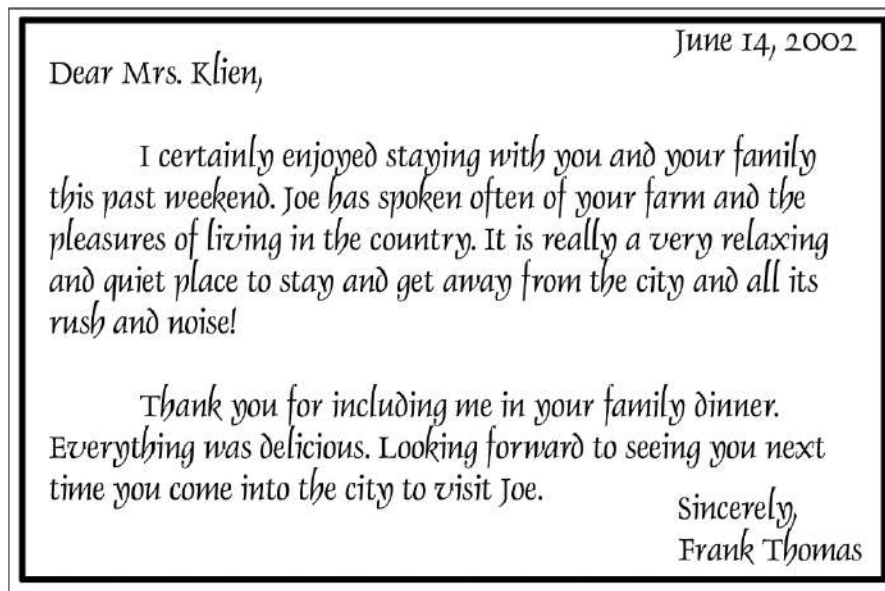

function with uninvited guests! You may ask the hostess if you may bring a guest (if you feel comfortable doing so – perhaps you know the

Thank You Notes

Every host and hostess appreciates knowing his or her guests had a good time! It is always appropriate to send a written thank-you – even if you have thanked him or her verbally.

You should write thank-you notes the next day, but not more than a week after receiving a gift, attending a social function, or being someone’s houseguest.

Thank you notes do not have to be long. They should, however, be hand-written and on your best stationery. Be sure to mention something specific about the function or gift – and be certain to be sincere! Even if you did not

have a good time, be certain to sincerely thank the host or hostess for inviting you.

Commercial thank you cards are acceptable only if you write a personal note inside.

Being Late? When to Leave?

Have you heard the expression, “being fashionably late”? Being late is not “fashionable” and is rarely appreciated! If you will be 15 minutes or more late, it is appropriate and most courteous to call the host or hostess. It is especially important to be punctual for receptions, parades, luncheons and/or dinners.

If you are an invited guest or are escorting someone to a parade, you should arrive 10 to 15 minutes early in order to be seated before the event begins.

As an invited guest to an open house or other social event that gives an arrival and departure time, for example “5 p.m. to 7 p.m.,” you do not have to arrive promptly at 5:00 p.m., nor do you need to stay the entire time. You may arrive anytime before the last half hour and should stay at least 30 minutes.

Arriving late as a dinner guest is not only inconsiderate, it may cause the meal to be overcooked! It is also important not to arrive early! The last few minutes before a party belong to the hostess, so if you arrive early, walk or drive around the block. Your hostess will appreciate your consideration!

If no departure time is noted on an invitation, you should leave within 2 hours of the stated arrival time.

As a dinner guest, you should stay at least 30 minutes after the meal is finished.

Receptions usually last two hours. You should stay at least 45 minutes or until the senior guest or guest of honor departs. If you depart before the senior guest or guest of honor, be certain to say farewell to him or her and explain that you must leave.

Before leaving any social event, be sure to thank your host and hostess (unless they are still in the receiving line).

A good rule to remember for any social event: Be on time, but never early, and leave before you wear out your welcome!

Notes and Shorter Letters

The letter you write, whether you realize it or not, is always a mirror that reflects your appearance, taste and character. A “sloppy” letter with the writing all crowding into one corner of the page, badly worded, badly spelled, and with unmatched paper and envelope – even possibly a blot – says you are the sort of person who would have messy hair, clothes that look like you slept in them, and broken shoe laces. But a neat, precise, evenly written note portrays a person of who is neat, well mannered, and considerate.

Some people are lucky and are able to write graceful letters, to space their words evenly, and to put them on a page so that the picture is pleasing. But even if your writing is not perfect and you can only write rather badly formed letters, if the writing is consistent throughout, the page as a whole looks fairly good.

Dating a Letter

Usually the date is put at the upper right hand of the first page of a letter, or at the end, and to the left of the signature, of a note. It is easier to read January 9, 2002, than 1-9-02.

For a personal note or letter, you may close with “Yours truly,” or “Sincerely yours.”

The best ending to a formal social note is, “Sincerely,” “Sincerely yours,” “Very sincerely,” or “Very sincerely yours.”

Etiquette in Smoking

Many places these days do not permit smoking, but if smoking is allowed, a gentleman should not smoke under the following circumstances:

- When walking on the street with a lady.

- When lifting or tipping his hat (usually an elderly gentleman's practice of long ago tradition).
- In a room or an office when a lady enters.
- In any short conversation where he is standing near or talking with a lady.

If he is sitting with a woman and they are having a conversation, anywhere where "smoking is permitted," he is considered most polite if he asks, "Do you mind if I smoke?" If she replies, "Not at all," it is then appropriate for him to do so. He should, however, take his cigar, pipe, or cigarette, out of his mouth while he is speaking.

Remember, smoking is a habit to be avoided, if at all possible, as it is a definite health hazard!

Conclusion

It takes a little thought and perhaps a little extra time and effort to learn and practice good manners. It takes some thought and some planning in advance to dress appropriately. In the long run, however, you will have more self-confidence and a more positive self-image if you are a model of sincere consideration of the feelings and interests of others. You will also gain the respect and admiration of those around you and those you meet. ❖

Proper Table Manners

PURPOSE

Good table manners are good manners anywhere – whether you are at home, dining at a friend's house, or in a luxury hotel. Although customs may vary from country to country, good fundamentals in eating are generally the same. The correct use of silverware should be as easy and familiar to you as the proper use of any tool or appliance you use on a daily basis.

Mealtime is a time for enjoying good food and also enjoying the company of others. Pleasant conversation along with the relaxation that comes with knowing what to do will make dining a pleasant experience. But it takes everyday practice before your manners at the table become easy and automatic.

Introduction

The modern-day use of tableware goes back to 1100 A.D. when the wife of an Italian nobleman introduced the two-tined fork into table usage because she did not like to pick up food with her fingers – particularly meat. The use of the fork spread very slowly and was not really completely accepted until the Renaissance when the knife was introduced to replace the common hunting knife which in that day and age every freeman carried at all times on his belt and used at the table for cutting his meat. Can you imagine bringing a hunting knife to the table with you to dine in a fine restaurant?

The English began to manufacture table knives and forks in the mid-1600s, when they also introduced the use of the spoon.

The first napkins appeared in Reims, France, in the courts of Charles VII. Napkins were used exclusively by the nobility and were often trimmed in lace and intricate embroidery. Later in the seventeenth century, napkins became important as decoration on a table, often folded in very intricate ways to represent birds, flowers, and fans. Supposedly, there are 400 ways to fold a napkin – but who's counting!

Meals

Dinner is considered the main meal in the United States, when, except on Sundays and holidays, it is eaten in the evening. Many people have their dinner at noontime on Sundays and holidays. Lunch is the everyday noon meal and a light or informal evening meal is usually called “supper.” In certain sections of the country, dinner is considered the noon meal and supper the evening meal. These days with our busy schedules, families often do not follow this practice, and often do much eating “on the run” and without everyone in the family eating at the same time – or even at a table.

Suppers may be held after formal occasions such as weddings, dances, and receptions, and may be served very late. Buffet meals in the evening are referred to as “suppers” – never as “dinners” – even when guests are in evening attire.

In many foreign countries, dinner is not served until 9:00 or 9:30 in the evening.

Dinner – Setting the Table

The one basic rule in setting the table is to make certain that everything on the table is geometrically spaced. In other words, you place a centerpiece in the actual center of the table, the “places” at equal distances, and all utensils are balanced. Beyond this one rule you may set your table as you choose.

First, place the necessary number of plates around the table at equal distances. The place knife, fork, and spoon are the most frequently used utensils for most meals. To the right of the plate, and nearest to it, you put the place knife with the blade toward the plate. Then, if soup will be served at the meal, you place a soup spoon. If soup is not served at this meal, you put the place spoon to the outside of the knife. On the left of each plate, you put the fork so that it is nearest to the plate. There are other specialty knives, forks, and spoons used for more formal or elegant dinners. These include the teaspoon (often used instead of a place spoon at informal meals for dessert, coffee, tea, cereal, grapefruit, etc.), a salad fork, seafood or oyster fork, dessert spoon, iced beverage spoon, and demitasse (coffee) spoon, just to name a few. These additional forks and knives (if needed) are put on the table during dinner or often at specific positions on the table before a meal is served. There are many special rules for placing these additional pieces of flatware. You do not need to remember all of the special rules, just know that there are very specific rules. If you must help to set up a formal dinner, check an etiquette book and follow the rules you will find there. You can also check the Internet for this information. The key word search is Emily Post.

In placing the glasses on the dinner table, the water goblet is at the top and to the right of the knives, and the wine glasses (if wine is served)

are either grouped to the right of the goblet, or in a straight line slanting down from the goblet obliquely towards the right.

A dinner napkin folded square and flat is laid on each plate. If place cards are used for the dinner, they are usually put above the plate on the tablecloth, but some people put them on top of the napkin because they are more easily read.



Manners at the Table

It is considered impolite to refuse dishes at the table, because your refusal implies that you do not like what is being offered to you. If you really do not like some item, to be polite, you should take at least a little on your plate and at least make a small effort to eat some of it.

You should sit down quietly in the center of your chair and draw it up to the table (if there is no one to push it in for you, ladies) by holding the seat in either hand while momentarily lifting yourself and the chair. It goes without saying that you must not “jump” or “rock” your chair into place at the table.

In getting up from the table, again you must push your chair back quietly, using your hands on either side of the chair seat. Do not hold on to the table edge and give yourself, chair and all, a sudden shove. There should never be a

sound made by the pushing in or out of chairs at the dinner table.

When not eating, sit up straight and keep your hands in your lap.

The best rule to remember about which piece of silverware to use when, is to remember to begin from the outside and work in toward your plate. There should not be more than three knives and three forks placed on the most formal of tables at any time. If you need more silverware, it is brought in with the courses for which it is to be used.

Bread and Butter

You should always break your bread into small pieces with your fingers before eating your bread. If you are going to butter your bread, you hold a piece on the edge of the bread and butter plate and spread enough butter on it for a mouthful or two at a time. Use a butter knife if one is provided at your place setting (and this happens most often at more formal dinners). Bread must never be held flat on the palm of your hand and buttered in the air.

The individual butter knife (sometimes called a butter spreader) is usually laid across the top of the butter plate, with the handle at the right and the blade facing the edge of the table. The butter knife is only used to spread butter. It is never used to take butter from the butter plate. A knife for that purpose is placed on the butter dish, if a butter dish is used.

How to Manage Hot Food, Bones, and Seeds

If you take a mouthful and your food is too hot, quickly take a swallow of water. Do not spit out the hot food. Even if you hate the taste,

you have got to swallow it. You must not take anything out of your mouth that has been put in it, except dry bones and stones or seeds from fruit. To spit anything into the corner of your napkin is **unacceptable!** It is also very unappetizing to see anyone spit skins or pits on a fork or into the plate. If you must remove some food item from your mouth, the only proper way to do so is between your first-finger and thumb.

The Proper Use of the Fork

The salad fork is shorter than the dinner or luncheon fork and may be used for either a salad or a dessert course.

Hold your fork just like you hold a pencil when you write; your thumb and two first fingers are closed around the handle two-thirds of the way up the shank of the fork, and the food is taken up shovel-wise on the turned-up **prongs**.

The Proper Use of the Spoon

To use your spoon, hold it in your hand like the fork. In eating soup, you must dip your spoon away from you – turning the outer rim of the bowl down as you do so. Do not fill the bowl of your spoon more than about three-quarters full because it is impossible to lift a brimming spoonful of liquid to your mouth without spilling some of it. Sip your soup, without making any noise, out of the side (not the end) of the bowl of the spoon.

You must never pile a great quantity of food on a fork and then lick or bite it off a little bit at a time. You may, however, sip a little soup at a time out of your spoon – especially if it is very hot. Remember, never make any sounds when you take any liquid either from a spoon or a glass.

The Fork and Knife Together

You may use either the American or the Continental way of eating, but the favored American custom is to hold the dinner fork in your left hand to pin down the food you are cutting, and then to transfer your fork, tines up, to your right hand for the purpose of eating. Once you have cut off a mouthful, you should lay your knife on your plate. The handle of the knife should be toward the right side of your plate and an inch or two beyond the rim of the plate. After using your fork, put it on the plate below the knife, with the handle at the right and the **tines** up.

You may never hold your fork clutched in your clenched fist, and you may never “saw” across your food at the base of your fork with your knife.

To be perfectly polite, you should only cut off and eat one mouthful at a time.

Of course, you know that the knife must never be put in your mouth. You must never use your knife to scoop baked potato out of the skin or to butter your baked potato. Take the butter on the tip of your fork shovel fashion, place it on the potato, and then press down and mix with the prongs held points curved up.

It goes without saying that taking a big mouthful (next to smearing your face and chewing with your mouth open) is the worst offense at the table.

When you have finished eating, you should lay your knife and fork close together, side by side, with handles toward the right side of your plate, the handles **projecting** an inch or two beyond the rim of the plate. They must be placed far enough on the plate so that there is no danger of their slipping on to the table or floor when removed.

The Serving Fork and Spoon

The serving fork and spoon are placed on the serving platter or in the vegetable dish. These utensils are much larger than other forks and spoons. When you serve yourself, you hold these utensils just like you hold other forks and spoons, with the fork in your left hand and the spoon in your right. Slip the spoon under a portion of food and, while holding the food in place with the serving fork, transfer the food to your plate.

Forks or Fingers?

All juicy or “gooey” fruits or cakes are best eaten with a fork. The best rule to remember is that if you cannot eat something – no matter what it is – without getting it all over your fingers, you must use a fork, and if necessary, a knife.

Some General Rules at the Table

There are many rules in eating a meal that may seem rather elementary, but you are judged by these rules. The difference between good or bad manners is the way you follow these rather basic rules!

- Do not talk with your mouth full, make noises while you are eating, chew food with your mouth open, or blow on hot liquids to cool them off.
- Do not smack your lips or take overly large mouthfuls of food piled high on your fork or spoon.
- Use your napkin before you drink from a glass of water to avoid leaving traces of food on the glass.
- Never lick your fingers after they have been in contact with food – use your napkin.

- If something is out of reach on the table, do not rise out of your seat to obtain it; ask someone to pass it to you. However, you may reach for anything you can conveniently reach without bothering your dinner partner.
- Be sure to remove the spoon from your cup after stirring and before drinking. Remember to place the spoon in the saucer, at the right of the cup handle and not on the tablecloth.
- You may tilt a soup plate away from you when the plate is almost empty. When you are finished, leave the spoon in the soup plate. However, you should not leave the spoon in a bouillon cup or cream soup bowl. You may drink clear soup without a spoon if it is served in a bowl with handles or in a cup.
- You should keep your elbows at your sides when cutting food. Your elbows move just as easily up and down as sideways (like a bird flapping its wings), and if held in, cannot hit the person sitting next to you at the table.
- Avoid twisting your feet around the chair legs or extending your legs under the table.
- When finished eating, do not push back your plate. Leave it where it was placed. Lay your unfolded napkin at the left side of the plate, not in it.
- Whenever you use your napkin, pat your lips – do not rub them!
- Loud talking and laughter at the table are disturbing to others so be careful not to speak too loudly. Do not bring up **controversial** or unpleasant subjects, such as politics, religion, or death. Always remember not to discuss personal affairs or the opposite sex at the table, or before groups anywhere, for that matter.

- “Small talk,” the pleasant, interesting things of everyday life, such as a movie you just saw, a book you recently read, or your trip to Disney World are always safe topics of conversation at the table.

Elbows on the Table?

Elbows on the table – and this may surprise you – are used only on occasion and for a very specific reason. Elbows are often seen on tables in restaurants, especially when people are lunching or dining at a small table for two or four, and it is impossible for people to hear each other above the music or other noise in the restaurant. At the same time, people try not to be heard at other tables nearby. You really cannot do this without leaning far forward. At home, when there is no reason for leaning across the table, there is no reason for elbows on the table. At a dinner of ceremony, elbows on the tables are rarely seen, except at the ends of the table, where again you might have to lean forward in order to talk to a companion at a distance across the table corner.

Never put your elbows on the table while you are eating. Between courses, you may, for a moment, place your forearms on the table, but only if you do not turn your back on the person sitting next to you. Sitting with your left elbow propped on the table while eating with your right hand (unless you are alone), or propping your right elbow on the table while lifting your fork or glass to your mouth, is never done.

Dropped Silverware

As a guest in someone’s home or dining at a restaurant, when you drop a fork or spoon at the table, do not pick it up. When you need another one, ask the server for it, or the hostess, if she has not noticed. Do not apologize for the

mistake. The less you say about the incident, the less it will be noticed.

Unexpected Situations

Use your common sense when coughing, sneezing, or you need to blow your nose. Try a sip of water for a fit of coughing, but if that does not work, leave the table. If you find you must sneeze, use your napkin or a Kleenex or handkerchief, if you have one. If you must use a Kleenex or handkerchief, do so as **unobtrusively** as possible.

If you need to leave the table, do so quietly, and when you return make your apology quietly. Again, do not draw attention to yourself.

If a person is choking on a piece of food – or anything else – he/she needs help immediately. From the moment that something is lodged in the windpipe and oxygen is cut off, the victim has no more than four minutes to live. You do not have time to call a doctor. A choking victim while conscious – and he is only conscious a very short time – cannot speak and is in distress. He can nod his head when asked if choking. The symptoms of choking are similar to a heart attack: an inability to breathe; growing pale, then turning blue; then becoming unconscious. To help the victim, apply the Heimlich Maneuver.

The Heimlich Maneuver

The American Medical Association endorses the use of the **Heimlich Maneuver**, a “bear hug” technique for stopping someone from choking.

When the victim is standing or sitting, stand behind him, wrap your arms around his waist, then make a fist with one of your hands and place it, thumb-side in, above the victim’s navel

but just below the rib cage. You grasp the fist of your other hand and press with a quick, upward thrust. Repeat several times, if necessary. Because there is always **residual** air trapped in the lungs, the sudden pressure forces the air upward, and the obstruction is expelled.

When the victim is on the floor, unconscious, you should place him face up and kneel astride his hips. With one of your hands on top of the other, place the heel of the bottom hand above the navel and below the rib cage and give a quick upward thrust.

If you are alone and choking, press into a table or a sink – try anything that will apply force just below your diaphragm – or use your own fist.

If the victim is an infant, you must be very careful. You place the infant on a firm surface, or on your lap facing away from you, and then make a cushion of your fingers while using both hands to make an upward thrust.

Dining in Public Places

In most restaurants, there are two ways to order your meal. You can order “**table d’hote**” and “**a la carte**.” “Table d’hote” means paying a single price for a complete meal as outlined in the menu. When you order “a la carte,” you pay a specific price for each item you order. Ordering “a la carte” is always more expensive, but you get exactly what you want.

Please remember to be courteous to your server. Do not address a server as “Boy” or “Hey you.” It is appropriate to address the server as “Waiter” and the waitress as “Waitress” or “Miss.” Today, it seems many servers prefer to be called “Waitperson” (and that term may therefore be considered appropriate). When the server is busy, do not attract his or her attention by clapping your hands, drumming on the table with silverware, or

hissing. When a server passes within hearing distance, but does not notice you, you may call “Waiter” or “Miss” in a clear voice, but do not bark at him or her for attention.

If your food has been prepared improperly – for example, your steak is cooked well done rather than medium rare – make your complaints to the host or hostess. Mistakes do happen, but they may not be the fault of your server. Do not lose your temper or make a scene.

It is thoughtless of anyone to stop and talk at a table when hot or very cold food is in front of those being served. It is far better to nod or speak very briefly and then go on your way; you can talk with your friend later during a lull in the service or over coffee at the end of a meal.

In any public eating place, never wipe your silverware with your napkin. If the silverware does not appear to be clean, ask the server for fresh silver.

After you have been seated in a restaurant and look at the menu, you may find that what you want is not listed, or that you cannot afford the prices. If you have not used any of the silverware or touched the water glass or napkin or disarranged anything else, you may get up and leave. If your water glass has been filled and bread or crackers have been brought to the table, you should leave a small tip, explain to your server why you are not staying, and go!

Tips are 15 percent of the entire check at the average restaurant, but these days at a better restaurant, you should tip 20 percent of the entire check. On occasion, the tip may be automatically added into the check amount. Check with your server if you are not sure whether to add a tip. Remember, although most good restaurants and hotels accept credit cards, some do not, so phone first and find out.

Conclusion

Good manners are not turned on or off depending on the importance of the occasion or the individual with whom you are sharing a meal. It is equally important to practice good manners at home as well as in a fine restaurant. Just as people judge you by the clothes you wear and the way you speak, you are often judged by how well you practice good manners at the table. Fair or not, this is a fact of life. The best way for you to be comfortable and **proficient** in using good manners is to use them on a daily basis. There is nothing difficult about using good manners. After a while, you will use them without having to give them a single thought. You will know exactly what to do.❖

Effective Study Skills: Note-Taking and SQ3R

PURPOSE

To work smart, you need to develop strategies for studying.

And how do you study? Usually you start with your textbook. Good readers know how to study effectively by using hints and clues provided by the writers of their textbooks. Good readers and those who study effectively preview each chapter by first looking at topic headings; questions at the end of the chapter; key words in bold in the text; pictures, graphs, and charts and the text underneath each of those graphics before they read or take notes. Good readers raise questions and make plans for reading in order to gain the most out of their textbooks.

Using study strategies helps you understand what you read, make connections among the important ideas in your text, and summarize what you read. When you take notes, you remember what you read and have a tool for studying for quizzes and tests.

Introduction

Learning by using your textbook or any reference book or resource you might need when you write a paper, give a presentation, or complete a project, is hard work. In fact, learning to study effectively is much like learning to be an excellent gymnast. A gymnast must be disciplined and patient. He or she must train and practice physically the skills required to perform flawlessly in competitions. Just like a gymnast, you must

train and practice mentally when you study if you want to perform well in school and later in the workplace. You must be disciplined and patient in learning to work and study smart.

What are the study strategies you need to work and study smart? The most basic and helpful of study strategies are perhaps learning how to take good notes and how to use a textbook reading/study method called SQ3R.

Making Notes

An effective study strategy for remembering information in your textbook is to **annotate** what you read in the form of notes. Notes can be put on study cards (index cards) or in a **learning log**. A learning log may be a notebook you keep specifically for the purpose of putting together your written reactions to and reflections on what you read in your text.

In taking notes, you should avoid copying word for word from the text. Instead, you need to take notes that **paraphrase** (put in your own words), **summarize** (briefly restate the important facts or main points), **react critically** (carefully evaluate or judge what you read), question, or respond personally to what you read.

Before you look at the different kinds of notes you can make about what you read in your textbook, read the following short passage. When you have finished reading the passage, you can look at the different types of notes you could use to record what the author says and what you think about what the author says. The sample note cards are based on the following reading passage entitled “Wild Cargo: The Business of Smuggling Animals.”

Wild Cargo: The Business of Smuggling Animals

Around the world, there is increasing unpleasantness for those trading illegally in wild animals and wildlife products. Within the past decade, government after government has passed laws to restrict or prohibit the sale of wildlife that has been seriously reduced by hunting and habitat destruction. With legal channels pinched, animal dealers have resorted to evil schemes to continue the flow.

Wildlife is big business. Exotic-bird collectors will pay \$10,000 for a hyacinth macaw...In New York I tried on a pair of trendy western boots trimmed in lizard skin. The price? “Two hundred thirty five,” the clerk said, with a sly smile that suggested most of his customers didn’t bother to ask....

These items are being sold legally. But somewhere in the dim beginnings of their trail through commerce, they may have been acquired illegally....

The fascination with wildlife within the affluent nations of the world adds to the disappearance of animals in the less developed countries. Illegal traders are willing to go around the wildlife-protection laws to satisfy the demand and their own pocketbooks....

Wildlife smuggling is costing the U.S. millions of dollars to control. This smuggling is also denying income to the treasury of any nation that would otherwise receive duty from legal imports. It has spread diseases that would have been detected in legal quarantine periods...One terrible effect of this illegal trade could be the extinction of animal species that are finding fewer and fewer places to hide.

Source:

Grove, N. (1981, March). Wild cargo: The business of smuggling animals, *National Geographic*. pp. 290-294.

Types of Notes

There are several types of notes you may find useful as you study: the summary note, the thesis note, the critical note, and the question note.

Summary Notes

The **summary note** shortens the main ideas of a section of your text into a concise statement of what you read. Summary notes are brief, clear, and express a lot in a few words.

When you write a summary note about **expository** material (text that explains an idea or topic), you need to include all the important ideas but *not* the supporting information and detail. Details do not belong in a summary note. When you write a summary note about **narrative** material (such as a story) your note should be only a very brief statement about the major elements of the story, such as the characters and main events of the plot.

A Summary Note

The illegal trading of wildlife is a profitable business in affluent countries around the world. Continuing this type of trade threatens both developed and underdeveloped nations. It affects these nations economically and ecologically. More recent laws are making this illegal trade much more difficult to pursue.

Thesis Notes

When you write the **thesis note**, you answer the question, “What is the main point the author has tried to get across to me?” The thesis

note is like a telegram. It is a very short and clear statement of the author’s main idea. If you write a thesis note for a story, you identify the theme of the story.

A Thesis Note

Illegal wild animal trade is a very profitable business for those who practice it, but it is a threat to humans and their environment. More laws throughout the world can restrict this activity.

Critical Notes

In the **critical note**, you answer the question, “So what?” In other words, when you write a critical note, the first thing you do is state

the author’s thesis or main point. Then you state your position about that main idea. Finally, you defend or provide more explanation about the position you have taken on the author’s idea.

A Critical Note

Trading wildlife for high profits is something all of us will pay for ultimately. Countries are being cheated out of needed revenues. More importantly, the future of some species of animals is threatened. The money-hungry traders also give little thought to the spread of disease that could be avoided by legal quarantines. All nations need to cooperate to pass stricter laws to control or prohibit the trade of wildlife and its very survival for the temporary wealth of the illegal traders.

The **question note** does exactly what its name suggests – it raises a significant issue in the form of a question that you have thought about as

you read the material. Your question is the result of what you think is the most significant aspect of what you have read.

A Question Note

(Should illegal wildlife trade be allowed to continue or, at least, be ignored, after unsuccessful attempts to stop it?) NO!

The author says more laws instituted by governments around the world are making life more unpleasant for illegal traders of wildlife and wildlife products. He also cites serious economic and ecological reasons why no one should give up the fight.

Tips for Note Taking

Here are some useful tips for making notes on cards:

- *Use ink.* When you write in pencil and then you use your notes to study or perhaps to prepare to write a paper, you tend to shuffle your cards as you organize your thinking. Pencil notes smudge easily with repeated shuffling of cards.
- *Use index cards.* Index cards are definitely more durable than large sheets of paper. Also, index cards are much easier to rearrange and organize than notes written on large pieces of paper.
- *Jot down only one item per card.* Do not overload a card with more than one type of note or one piece of information. Having one type of note or only one piece of information on a card makes it much easier for you to rearrange and organize your thinking.
- *Write on only one side of the card.* Information you record on the back of a note card may be overlooked or forgotten when you are studying for a test or preparing to write a paper.

A Two-Column Note Taking System

Can you believe it? You forget over 50 percent of the material you read or hear in class in just a few minutes. If you learn and use a system for taking and making notes, you will be able to recall information and overcome your tendency to forget what you read or heard.

You just looked at a system for taking notes on index cards. Here is another popular note-taking procedure, one that uses regular loose-leaf notebook paper. (See example on next page.)

Here are the steps in this 2-column note taking system:

- Use only one side of an 8 ½ by 11-inch sheet of loose-leaf paper with a legal-width margin. If you do not have that kind of notebook paper – no problem. You can make your own margin just by adding a margin line 3 inches from the left side of your paper.
- Take notes to the right of the margin (either from a class lecture or from your textbook or other resource). You are not required to use a specific format for taking notes. You should develop a format that works for you. A good format uses indenting to indicate main ideas and details. In other words, list your main ideas just to the right of the margin you created. Then indent each time you include a detail that helps explain or support your main idea. This is called using **subordination** and space to show how your material is organized.
- In the left-hand margin, label the notes you recorded to the right of your margin. The labels help organize information in the right-hand column. As you write your labels, you can also fill in any gaps in the notes. You need to complete this labeling process as quickly as possible once you have taken all your notes from a class lecture or a reading passage. You will have the most success if you label as soon as you finish reading a section of your text or right at the end of a class where your instructor has given a lecture.

Labels	Notes
Neurons are detectors that signal messages to the brain	Our eyes, ears, nose, tongue pick up messages & send them to the brain. <ol style="list-style-type: none">1. Lens of the eye focuses light on the retina, & neurons change it into a message carried by the optic nerves.2. Tongue & nose work together to detect chemicals & send message to the brain<ul style="list-style-type: none">• Tongue has areas for sweet, salty, sour• Each area has neurons3. The skin has neurons that detect pain, pressure, touch<ul style="list-style-type: none">•

How to Use Your Notes

Once you have taken notes and finished labeling them, you can use your notes to study for quizzes and tests. For example, when you prepare to take your test, you can spread out the note pages for review.

- Spread out the pages of your notes, in order, so that you hide your notes from the lecture (or your text) with the succeeding pages and only the left-margin labels show.
- Now you can use your labels as question stems to recall information – for example, “What do I need to know about *(label)?*”
- You can check to see if you recall the information by uncovering and referring to your original notes.

Using SQ3R as Your Study System

Besides the two different formats for taking notes, there is a study system that has been around for more than a half-century that is also a very good way to take notes for studying and remembering what you read in your textbook. It has stood the test of time, and students today find it just as useful and effective as students from long ago.

A study system, as the name implies, provides you with a systematic approach for studying text. SQ3R is the acronym for this system and it stands for *survey, question, read, recite, and review*. SQ3R has one purpose in mind: to help you study texts on your own.

The steps in SQ3R are as follows:

- *Survey*. Preview the material to anticipate content, make plans for reading, and develop

a mental framework for ideas you will encounter in the text.

- *Question.* Raise questions with the expectation that you will find the answers in your text. A good way to raise questions is to take each of your headings and subheadings, even your key words, and turn each into a question.
- *Read.* Search for ideas and information that will answer your questions.
- *Recite.* Try answering your questions by “rehearing” aloud what you have learned and/or writing responses to the questions you raised. Writing the answers to your questions is perhaps the most effective activity to do in this step.
- *Review.* Review and reflect on the material by organizing and elaborating on the ideas you encountered in the text. Re-read portions of the text to verify or expand on your responses to the questions you created.

Questions to Ask

To analyze your reading task and make plans, you need to ask questions such as the ones below:

- What kind of reading is this? (Informational? Expository? Narrative?)
- What is my primary goal or purpose in doing this reading? (Acquire information? Read to learn an author’s point of view? Learn a process or procedure for doing some activity?)
- Should I try to remember details or read for the main ideas only?
- What do I already know about the topic? What do I need to know?

Now that you have seen the steps in the SQ3R system, take a closer look at what you do in each step and how each step helps you.

Survey and Question

Surveying gives you some idea of what a text selection is about before you read it. It prepares you for what is coming. Most of us have a tendency to jump right into an assignment, often without rhyme or reason, and just try to plow through it. However, when you learn how to survey material, you do not forge ahead without knowing what is coming. Surveying helps you raise questions and set purposes for your reading and studying. The Survey step in SQ3R prepares you for what you must do to work smart.

Question

When you raise questions about the material that you survey, you become involved in a search for answers during your reading. You become an active participant in reading, not just a mindless wanderer through a sea of words.

The Value of Surveying

Here is a true story to prove how useful surveying can be. In 1959, a Harvard professor named William Perry conducted an experiment with 1500 freshmen who were probably among the “finest readers in the country.” He assigned a chapter from a history book and instructed the students to use their best strategies to read and study it. After about 20 minutes, he asked them to stop reading and answer multiple-choice questions on the details of the chapter. Not surprisingly, the vast majority of the students scored high on the test. Yet when they were asked to write a short essay summarizing the main idea of the chapter, only 15 students did so successfully. Why? Because these 15 freshmen,

about one percent of the students in the experiment, took the time to preview the chapter before plunging into the details of the material.

You will find that the Survey phase of SQ3R works well when what you have to read contains format features that are organizational, **typographic**, or visual. Text writers use these aids as guideposts for readers.

Organizational Features of Textbooks

Certain organizational features often found in textbooks, such as introductions and summaries, give you valuable clues to the overall structure of a text or the important ideas that you will come across as you read. Headings and subheadings in your textbook show you the main ideas in your reading and how those ideas are sequenced and related to each other.

Key Words

Key words may also be highlighted in your text. Sometimes key terms appear in **bold** or in *italics*. Key terms in a business text, for example, may lead to questions such as these: “What do you think the author means by *values*? What does *budgeting* mean? What does budgeting have to do with *financial planning*?” Open-ended questions such as these help you focus your attention on the material. The key words also illustrate the value of **predicting** and anticipating content.

Visual Aids

You will find that typographic and visual aids, especially in electronic texts, are valuable tools to use in surveying. You can survey chapter titles; headings and subheadings; words, phrases, or sentences in special type; and pictures, diagrams, illustrations, charts, and graphs before you read to get a general outline – an agenda, so to speak – of what to expect.

When an author of a textbook uses visual aids in the text, he or she has a definite purpose in mind. In some cases, the textbook author may use an aid to expand on a concept developed in the main text. In other cases, the textbook writer may insert a graphic as an example or an illustration of an idea he or she has introduced.

Visual aids, particularly charts and tables, also help you by summarizing and organizing information. Additionally, many aids, such as photographs and drawings, can provide you with experiences by adding an example to text statements.

General Rules to Follow

As a general rule, you should learn and follow these steps when you survey the text you are about to read:

- *Read the title.* Change the title into a question. For example, if you were surveying this chapter, you might ask yourself, “What are effective study skills?” or “What is SQ3R?” or “What is the best way to take notes?”
- *Read the introduction, summary, and questions.* What seems to be the author’s main points? In the case of this textbook, you could read the purpose, introduction, and conclusion. You learn that using study strategies is hard work, but it pays off. You will understand and remember what you read or hear in a lecture if you use SQ3R or note taking system. You already know the main points of this reading, so you know what to expect in reading the rest of the content of this chapter.
- *Read the headings and subheadings.* Convert them into questions. If you take your headings for this chapter and change them into questions, you might write the following: “How do you take notes?” and “What kinds of notes can you take?” and “What are some good tips for

making notes?” Turning your heading into questions tells you what information you need to focus on in your reading.

- *Read any print in special type.* Why are certain words, phrases, or sentences highlighted? If you look again at this chapter as an example, you see that words such as *expository, narrative, critical note, predicting*, etc., tell you what you are dealing with when you read text, the activities you need to perform as you read your text, and the types of notes you can make. The highlighted words, like the headings and subheading, help you focus on your reading and tell you what is important as you read.
- *Study visual materials such as pictures, maps, and diagrams.* What do the graphics tell you about the chapter’s content? Once again, using this chapter as your example, you see that the textbook writer has given you some sample notes from an actual reading passage. These visual materials help you understand what is being said by providing you with models to follow as you begin note taking.

Read

Studying text does not mean reading each word, each sentence, each paragraph, and each section of a text with equal emphasis. You need to be a **flexible** reader to study your texts independently and effectively. You need to know when to **skim** quickly over text; when to slow down for careful reading; when to read selectively, skipping segments of text that do not pertain to your search for information; and when to reread.

Being Flexible Means Skimming Text

What do you think it means to be a flexible reader? Concepts of skimming, careful reading, selective reading, and rereading are all

involved. You probably know what it means to skim a stone on a pond or to skim on ice or snow when ice skating or skiing? Skimming, as it applies to reading, involves glancing quickly over the material to see what it is about.

When is it appropriate for you to skim text quickly? It is critical to read the first sentence (usually a topic statement or important idea) of every paragraph, but skim an entire text selection rapidly – in no more than one or two minutes. Zip through every page and do not get bogged down on any one section or subsection. Now, if you try to recall everything that you have read, you will be amazed at the quantity and quality of your recalls.

Adjust Your Reading Rate

You also need to think about adjusting the rate (or speed) at which you read. You read at different speeds depending on your purpose for reading. If you come across a section of your textbook or reference book that has difficult and unfamiliar words and/or concepts, you need to slow down, read carefully, and reread to figure out the meaning of that reading passage. If you are familiar with a topic in your reading assignment, you should increase your rate of reading.

Recite and Review

The recite and review phases of SQ3R play very important roles in this study system. If you are to remember information and if what you remember is meaningful to you (and not just memorized for the test), you must rehearse aloud (literally “rehear”) or write about what you are learning. Here is where you make use of your note cards or notes on loose-leaf paper (or what some instructors call a learning log) to write responses to questions.

Recite

If you use a learning log to record information, you need to set up a double-entry format in which you put questions in one column and responses in another. This looks just like the note taking system explained earlier with the labels in the left-hand column and the notes in the right-hand column of a sheet of loose-leaf paper. You just replace the labels with questions in the left-hand column and write your answers to the questions in the right-hand column. Alternatively, if you like the index card note taking system, then you put the question on one side of the card and a response to the question on the other side.

You must write responses to questions in your own words rather than copying from the text. If you just copy word for word right from the text, you will most likely not remember as effectively as you will when you write the response in your own words. Writing in your own words ensures that you understand the information.

Review

Review is your best opportunity to reflect on what you read. One of the best ways to review what you just learned is to organize your ideas and expand the ideas you came across in your reading. You can write summaries or critical notes or construct graphic representations to show the relationships among ideas from your reading. Another way you can review is to respond personally to what you have read. You can think about questions such as “What aspect of the text interested me the most?” You might try to answer, “What are my feelings and attitudes about this aspect of the text?” Or you can consider a question such as, “What experiences have I had that help others understand why you feel the way you do?”

Do You Need to Use all the Phases in SQ3R?

The really great point about learning and using SQ3R is that you do not have to use all of the phases of the study system to study text effectively. You can blend aspects of SQ3R into a system of learning, choosing those study strategies that seem to work best for you and the subject you are studying. A system for studying text will evolve gradually within you over time – with practice.

You need to learn how to become “text-smart.” Being text-smart is similar to being “street-smart.” It is knowing how to stay out of trouble; it is knowing when and when not to take shortcuts; it is knowing how to survive and triumph over the everyday demands that are a part of your life in the classroom.

Becoming a student who is effective and works smart requires time, patience, and practice. Studying is a process that you learn through trial and error and the repeated use of different strategies in different learning situations. As you experiment with using the different types of note taking and some or all of the phases of SQ3R, you will discover that some strategies work better for you than others in different learning situations.

Conclusion

Learning how to study texts and work smart involves becoming an independent learner. You can see that text structure plays an important part in study strategies that you can use in taking notes and using SQ3R as a study system.

Recognizing how textbook writers organize their ideas in your textbooks will help you. Textbook writers write to communicate to you, their reader. They organize ideas to make it possible for you to get the information you need

to learn new ideas and concepts. The more you see a writer's text patterns (introductions, headings, subheadings, key words, conclusions), the more likely you will remember and interpret the ideas you come across in your reading. The more you use these text patterns in SQ3R, the more likely you will remember what you read.

Taking notes is another useful strategy for studying text. Making notes allows you to reflect on and react to important ideas in your textbooks.

Use note-taking and SQ3R. These strategies can help you be a more effective learner.

Reference:

Vacca, R., & Vacca, J. (1999). *Content area reading: Literacy and learning across the curriculum*, 6th edition. New York: Addison, Wesley, Longman, Inc. ❖

Communicating Effectively through Writing

PURPOSE

This lesson will describe the elements of communication and the communication process. You will learn the importance of communicating effectively through writing. You will learn tips to improve your written communication skills by recognizing categories of errors in writing. You will learn the role and importance of a topic sentence.

Introduction

Every day, one of your main activities is communicating with others. You communicate at home, at school, with your friends, and in the community. For some of you, you are also communicating in a job environment. For adults, communication at work can be the difference between success and failure.

The Need for Communication

We fulfill many different needs through communication, and effective communication can give us considerable pleasure. It pleases us when we have a stimulating conversation with a friend. We are also pleased when we participate in a group discussion that leads to a solution for a problem. We are happy if a letter we write is answered, and we are told that the recipient took what we said seriously.

Sometimes, however, communication does not work, and you end up feeling frustrated. You have a disagreement with a friend and do not

know what to say to fix it. There may be certain subjects your parents do not want to discuss at all. You write a message to someone and that person completely misunderstands what you said.

Even though we have been communicating since birth, we are not always as effective as we could be. Effective communication seems to be a problem for many people.

All communication depends on understanding others and having them understand us. Much of our communication is intended to influence what people think and feel. Most of the time we want someone to take some action as the result of our communication. We want a friend to spend vacation time with us; we want our friends to like each other; we want our parents to give us permission to go somewhere.

Perhaps our most important need is to maintain and improve our relationships with others. We use communication to discover each other's needs and to share our own needs with other people.

Our need for communication is important in all areas of our lives. To live is to communicate.

A Definition of Communication

Communication is a process in which people are able to transfer meaning among themselves. The communication process allows people to share information, ideas, and feelings. This is the transfer of meaning. Where no meaning is transferred, no communication has taken place.

Elements of Communication

The communication process is made up of various elements. These elements are communicators (senders), messages, receivers, channels (written words, sound, sight, radio, television), feedback, noise, and setting.

- The **communicator** is the originator of the message. The speaker, writer, artist, and architect are all communicators.
- The **message** is made up of ideas and feelings the communicator wants to share. The medium may be a speech, essay, or painting.
- The **channel** is the route traveled by the message as it goes between the communicator and the receivers. Airways may provide the channel for communicating the speaker's message; light waves are the channels for the writer, artist, and architect.
- The **receiver** is one or more individuals for whom the message is intended. The communicator must gain the receiver's attention to have effective communication.
- **Feedback** allows communicators to find out whether they are "getting through" to the receivers. You get feedback from your instructors, your parents, and your friends.
- **Noise** is interference that keeps a message from being understood. Physical noise keeps a message from being heard. An example of physical noise is having the television blasting while reading a letter. Psychological noise occurs when the communicators and the receivers are distracted by something. An example of psychological noise would be trying to concentrate on a writing assignment just before lunch, when all you can think about is eating.

Communicating Effectively

Once you understand the process of communication, you can begin to understand why communication does or does not work. In an ideal situation, the message is perceived in the way it was intended. For example, you write an apology to your friend for a mistake that you made. If the friend accepts the apology, the communication worked. If the friend was offended by your message, and the apology was not accepted, then the communication did not work.

Your communication may not have worked due to a problem with the message, the channel used may not have been the best choice, or psychological noise may have interfered. Asking the right questions about why communication did not work is the best way to improve communication skills.

Most of us already have considerable communication skills. We have been sending and receiving verbal and nonverbal symbols all our lives.

- **Verbal symbols** utilize the words in a language to stand for a particular thing or idea.
- **Nonverbal symbols** allow us to communicate without using words, such as facial expressions and gestures.

Nevertheless, we have all had times when we have not communicated as effectively as we should. You may have gotten a lower grade on a paper than you expected. You may have unintentionally hurt someone's feelings. An instructor may not have understood a question when you asked it in class.

You can work to increase the likelihood of effective communication. There are certain basic steps to follow when preparing any oral or

written communication. The six steps listed are not always used in sequence, nor are they exclusive of each other. You will want to tailor them to your own style and approach. These steps will help you focus your attention on how to increase your effectiveness as a communicator.

Steps in Effective Communication

1. *Analyze your purpose and your audience.* Make sure you know why you are communicating and to whom you are addressing your ideas.
2. *Conduct the research.* Use a variety of resources.
3. *Support your ideas.* Find facts, figures, statistics, and explanations that give credibility to your ideas.
4. *Get organized.* Use an outline or notes to organize your ideas into a logical sequence.
5. *Draft and edit.* Use language to your best advantage.
6. *Get feedback.* Test your work with one or more people.

Effective Writing

Writing is one of the acts or processes used to exchange ideas. When carefully chosen words work together to form grammatically correct sentences, and soundly structured paragraphs, communication is usually successful. Readers will understand your meaning, and respond accordingly.

But when a piece of writing is flawed, the process of communication breaks down; the transfer of information stops as the reader tries to translate your meaning.

There are many flaws that can damage your writing; among the most serious are ungrammatical sentences. **Grammatical errors**

include fragments, run-on sentences, subject/verb agreement, and shifts in person, number, tense, voice, tone, and faulty pronoun reference.

Fragments

A sentence is an independent clause, which can stand alone. It has a subject (what or who the sentence is about) and a predicate (tells what the subject does). A fragment is a dependent clause (a word group that lacks a subject or a predicate).

- Here is an example of a fragment:
“in the basement and in the attic”
- Here is an example of a complete sentence:
“We searched for the missing book in the basement and the attic.”

Run-On Sentences

A run-on sentence occurs if two or more independent clauses are joined without a conjunction (joining word such as “and” or “but”) or appropriate punctuation.

- Here is an example of a run-on sentence:
“Organize a résumé according to your education, work experience, career objectives, and recreational interests review your needs carefully before stating a career objective.”
- Here is an example of the correct way to write this:
“Organize a résumé according to your education, work experience, career objectives, and recreational interests. Review your needs carefully before stating a career objective.”

In the second example, the run-on sentence is written in two complete sentences.

- Sometimes a conjunction is used to connect two related clauses.

“A good résumé will include carefully chosen detail, *and* it will create an impression of depth without overwhelming the reader with your life history.”

Subject/Verb Agreement

Subjects and verbs agree with one another in number (singular or plural) and person.

Agreement as to number means that the verb takes a different word or spelling, depending on whether the subject is singular (one) or plural (more than one).

- Here is a singular example:

“The musician *is* a professional.”

- Here is a plural example:

“The musicians *are* professional.”

The verb in the above examples changed when the subject went from singular to plural.

Person is a term that indicates whether the subject is the one speaking (first person); the one spoken to (second person); or the one spoken about (third person).

- First person I walk to the store
- Second person You drive to the store
- Third person Joey flies to the store

Shifts

A shift, as defined in grammar, is an abrupt change of perspective within a sentence (or between sentences).

- A shift in person would be:

“People are tempted to go off *their* diets when *we* go on vacation.”

This is a shift from third person (“people”) to first person (“we”) within the same sentence.

- A shift in number would be:

“If the *books* belong to the boy, return *it*.”

The previous sentence is a shift from plural (“books”) to singular (“it”) within the same sentence.

- A shift in tense changes when the time of an action changes (past, present, future). An example of a shift in tense would be:

“Mrs. Hopkins *arrives* at her desk and *went* directly to work.”

The sentence above is a shift from present tense (arrives) to past tense (went).

- Voice is a term that indicates whether the writer has emphasized the doer of the action (active voice) or the receiver of the action (passive voice). Avoid shifting voices within a sentence.

“We went to the post office (active) and the letters were mailed (passive).”

One way to write this using only active voice is:

“We went to the post office and mailed the letters.” “We” took the action of going to the post office and mailing the letters.

- A shift in the tone of your writing can also confuse your readers. Tone refers to the quality of language (word choice, sentence structure) that creates for your reader an impression about your work and you, the writer. Your tone may be formal or informal. Once you adopt a certain tone, use it consistently.

“In your letter of May 16, 2001, you requested that we pay the balance of our bill, in the amount of \$25.31. You know, if you people would get your act together and correct the problems we told you about, maybe you would get your money.”

The paragraph above shows a shift from formal to informal.

Faulty Pronoun Reference

A *noun* is a word that names a person, place, or thing. A *pronoun* is a word used in place of a noun. Pronouns help avoid unnecessary repetition in our writing.

- Repetitive:
“Although Seattle is damp, Seattle is my favorite city.”
- Using a pronoun:
“Although Seattle is damp, it is my favorite city.”

Pronoun reference is a term that describes the relationship between a pronoun and its noun.

Noun ← Pronoun <i>The gentleman bowed to his partner.</i>
--

In order for a pronoun to function correctly, it must refer clearly to a well-defined noun, as in the example above. *His* can refer to only one noun in the sentence, *gentleman*. When a pronoun does not refer clearly to its noun, readers will be confused.

- Incorrect:
“Mr. Jones extended an invitation to Mr. Smith after *he* returned from *his* trip.” It is not clear who took the trip.
- Correct:
“After *Mr. Jones* returned from *his* trip, he extended an invitation to Mr. Smith.” Here, Mr. Jones clearly was the traveler.



Writing More Clearly

Writing a grammatically correct sentence is no guarantee that you will communicate effectively. Grammatical writing can still be unclear. Once you are confident that your sentences are grammatical, examine your choice of words.

Have you expressed yourself clearly? Have you avoided using **jargon** that may make your meaning unclear? Have you refrained from overusing *to be* or *to have* as main verbs? Have you chosen the better voice for your verb? Learning about these choices and thinking about them when you write, will improve the clarity of your writing.

Wordiness

Delete words, phrases, and clauses that do not add directly to the meaning of a sentence. Try to be less wordy and more to the point. Say your sentences to yourself with fewer words and see if it means the same thing. If so, use the version with fewer words.

- **Wordy** sentence:
“Under all circumstances and in every case, always check the oil level in your car when you stop at a service station.”

- To the point:
“Always check the oil level of your car when you stop at a service station.”

Jargon

Jargon consists of “shorthand” words, phrases, or abbreviations that are known only to a relatively small group of people. You should avoid jargon for two reasons.

1. Your audience may not understand what you are saying or writing.
2. Your message will be unclear when you rely on overused phrases as a substitute for original thinking.

Always choose your words carefully and know what they mean. Do not depend on phrases that add syllables but not substance.

- Jargon-Filled
Semi-permanent dyadic relationships provide the adolescent with the opportunities for trialing that make for a more secure union in the third and fourth decades.
- Jargon-Free
Going steady when you are a teenager helps prepare you for marriage later in life.

Overuse of “To Be” and “To Have”

Relying too heavily on forms of “to be” and “to have” as main verbs will diminish the effectiveness of your sentences. These words lack force as main verbs. These words do not establish for a reader the clearest possible relationship between the subject of a sentence and its predicate. When possible, substitute a verb that more clearly expresses action than “to be” or “to have.”

- Weak

“Ms. Smith was at the office door.”

- Improved
“Ms. Smith stood at the office door.”

Active and Passive Voice Sentences

Sometimes the same sentence can be written in more than one way. Consider the following:

- “The lawyer had won the case.”
- “The case had been won by the lawyer.”

The first example emphasizes the lawyer. It tells you something about the lawyer. The lawyer is the subject of the sentence. Since the lawyer is the one that did something (win the case), and you are writing about the lawyer, this is called active voice.

The second example emphasizes the case. It tells you something about the case. The case is the subject of the sentence. Since the case is the object that had something done to it (it was won by the lawyer), and you are writing about the case, this is called passive voice. Here is another example:

- Active: “Babe Ruth hit the ball.”
- Passive: “The ball was hit by Babe Ruth.”

The passive voice is less direct and less forceful than the active voice. Use the active voice whenever possible, unless it does not convey the meaning you intended.

Organizing a Paragraph

A **paragraph** is a collection of sentences logically arranged and focused on a narrowly defined topic. Like sentences, paragraphs rarely occur alone. They are parts of larger units: the

business letter or the memorandum or the essay for school.

Learning about the composition of paragraphs is important, the success of any larger form is entirely dependent on the success of its component parts. A letter will fail to communicate if any of its paragraphs is poorly structured or poorly developed.

The Topic Sentence

The **topic sentence** is a clue to the reader as to what the entire paragraph is about. The topic sentence should be just broad enough and narrow enough to allow approximately five to seven sentences about the topic. Depending on the topic, there could be more sentences. If some of your sentences are about a different subject, perhaps you should be starting a new paragraph with a new topic sentence.

Use topic sentences as an aid in organizing your writing. When you properly focus a topic sentence, you have a solid basis upon which to include or exclude information as you write a paragraph.

A good topic sentence also enables the reader to anticipate the contents of a paragraph and thus to follow your ideas as they are expressed.

Conclusion

Communication is how we transfer ideas among ourselves. Communication does not always work. Your message has to be perceived the way you intended it to be perceived.

You must understand your audience and your purpose. You should conduct research and support your ideas. You should decide on an

organization for your information and outline your ideas.

Once you start writing, you need to understand fundamentals of the English language. In order for people to respect and respond to your message, poor writing or inappropriate language must not distract them. Follow the basic rules and people will pay attention to your ideas and be impressed by your ability to express yourself.❖

Becoming a Better Listener

PURPOSE

This lesson will explain and demonstrate effective listening techniques and provide methods for becoming a better listener. You will learn the parts of the listening process, name barriers to effective listening, and explain how barriers prevent effective listening. You will learn tips to improve your listening skills by overcoming these barriers.

Introduction

Listening is the neglected **communication** skill. We spend nearly half of our communication time listening, but few of us make any real effort to be better listeners.

While all of us have had instruction in reading, writing, and speaking, we rarely get any training in listening. This seems like a misplaced emphasis when you consider that out of all the time we spend communicating (70% of our awake time), 10% of that time is spent writing, 15% is spent reading, 30% is spent talking, and an overwhelming 45% is spent listening.

Good listening is important to everyone. In the business world, listening is the communication most critical for success. But, listening also is important in other places -- at home, in school, in houses of worship, in civic clubs, and at social gatherings. Listening is important, not only for gaining information, but also for the building of relationships.

Listening is the skill that can make or break a relationship. It is as important to understand the person as it is to understand what the person is saying. There is a lot more to listening than just understanding the meaning of words.

The Process of Listening

Listening is a complex process. It is an essential part of the total communication process. Unfortunately, it is a part that is often ignored. There are two reasons why this happens.

First, speaking and writing, which are the sending parts of the communication process, are highly visible and are much easier to evaluate. We are much more frequently tested on what we read than on what we hear.

Secondly, we are not as willing to improve our listening skills. Much of this unwillingness results from our incomplete understanding of the listening process and how understanding the process could help us improve. In order to understand the process, we must first define it.

We can define the listening process as the process of **receiving**, **attending**, and understanding messages transmitted through the medium of sound. Often the steps of **responding** and/or **remembering** follow.

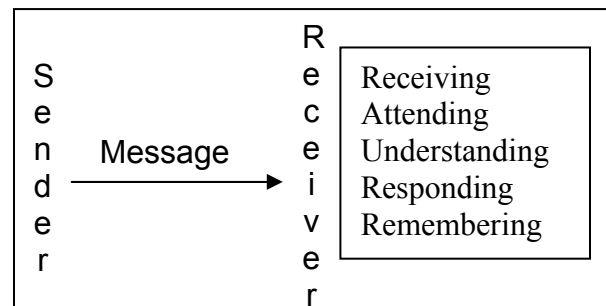

Receiving

Speaking is the call to listening. The speaker has not communicated until the receiver interprets and understands the message sent. Remember that **hearing** and listening are not the same. Hearing is the reception of sound. Listening is the attachment of meaning to sound. Hearing is, however, a necessary step for listening, and an important component of the listening process.

Attending

Hearing is only the first part of listening. We must interpret, appreciate, or evaluate what we are hearing. Good listening requires energy and concentration, even though we tend to think of it as an automatic process. After we have received a message, we must attend to it. Whether or not you attend to an incoming message, is a choice you actually have to make. Until you pick up the math book and study for the test, you have not attended to the message that a “math test is tomorrow.”

Understanding

Effective communication depends on understanding. That is, effective communication does not take place until the receiver *understands* the message. Understanding must result for communication to be effective.

Responding

Sometimes, during communication, a response is appropriate. There are several types of responses.

- *Direct verbal responses.* These may be spoken or written.
- *Responses that seek clarification.* This involves asking for further information.

- *Responses that paraphrase.* You may say, “in other words what you are saying is....” A paraphrase gives the sender a chance to confirm that you understand the message.
- *Nonverbal responses.* Sometimes a nod of the head or a “thumbs up” may communicate that the message is understood.

Responding is a form of feedback that completes the communication transaction. It lets the sender know that the message was received, attended to, and understood.

Remembering

Memory is often a necessary and essential part of the listening process. What is the relationship between memory and listening? Understanding the differences between short-term memory and long-term memory will help explain the relationship.

With short-term memory, information is used immediately, as with looking up phone numbers. This type of memory can only hold a limited amount of information, and is very sensitive to interruption.

Long-term memory allows us to recall information and events hours, days, weeks, and sometimes years later. For example, think of all the things you can remember that happened to you as you were growing up.

Types of Listening

Different situations require different types of listening. We may listen to obtain information, improve a relationship, gain appreciation for something, make discriminations, or engage in a critical evaluation.

While certain skills are basic and necessary for all types of listening (receiving,

attending, and understanding), each type requires some special skills. Before we can fully appreciate the skills and apply the guidelines, we must understand the different types of listening.

Informative Listening

With this type of listening, the primary concern is to understand the message. Much of our learning comes from informative listening. For example, we listen to lectures or instructions from teachers, and what we learn depends on how well we listen. If we listen poorly, we are not equipped with the information we need. There are three key factors for **informative listening**.

1. *Vocabulary.* Increasing your vocabulary will increase your potential for better understanding.
2. *Concentration.* Sometimes it is hard to concentrate because more than one thing is going on at one time. Or perhaps the listeners are preoccupied with other thoughts. At times people may be too concerned with their own needs, or perhaps they are just not interested. Some people have just not learned how to concentrate while listening. They have not made themselves responsible for good listening. Concentration requires discipline, motivation, and acceptance of responsibility.
3. *Memory.* You cannot process information without bringing memory into play. Memory helps informative listening in three ways.
 - a. It provides the knowledge bank for you to recall experiences and prior information.
 - b. It allows you to create expectations and decisions concerning what you will encounter by calling on your past experiences.

- c. It allows you to understand what others say. Without memory of words and concepts, you could not communicate with anyone else and understand the meaning of messages.

Relationship Listening

The purpose of **relationship listening** is to either help an individual or to improve the relationship between people. Although relationship listening requires you to listen for information, the emphasis is on understanding the other person. Three behaviors are key to effective relationship listening: attending, supporting, and empathizing.

1. *Attending.* In relationship listening, attending behaviors indicate that the listener is focusing on the speaker. Little things like nodding your head or saying “I see,” will let the speaker know that you are involved.
2. *Supporting.* Many responses have a negative or non-supporting effect. For example, interrupting the speaker or changing the subject is not supportive. Sometimes the best response is silence. Three characteristics describe supportive listeners.
 - a. They are careful about what they say.
 - b. They express belief in the other person.
 - c. They demonstrate patience (they are willing to give the time).
3. *Empathizing.* What is **empathy**? It is not sympathy, which is a feeling for or about another. Nor is it apathy, which is a lack of feeling. Empathy is feeling and thinking *with* another person. This characteristic lets you see, hear, or feel as others do. It allows you to “walk in someone else’s shoes.” Empathetic listening is critical to effective relationship listening.

Appreciative Listening

Appreciative listening includes listening to music for enjoyment, to speakers because you like their style, to your choices in theater, television, radio, or film. It is the response of the listener, not the source of the message, which defines appreciative listening. The quality of appreciative listening depends in large part on three factors: presentation, perception, and previous experiences.

1. *Presentation.* Presentation encompasses things like the medium (the form or way it is presented), the setting, or the style and personality of the presenter.
2. *Perception.* Our attitudes determine how we react to and interact with the world around us. Perceptions are critical to how and whether or not we appreciate the things to which we listen.
3. *Previous experiences.* Sometimes the experience we have had in the past influences how we appreciate or enjoy things. If we know too much about something, we may be too critical about it. If we have had pleasant experiences in the past with something, we start out with a more positive slant toward it.

Critical Listening

Critical listening goes beyond appreciative listening, for it adds the dimension of judgment. Critical listening is listening to comprehend and then evaluate the message. The ability to listen critically is especially essential in a democracy.

Discriminative Listening

By being sensitive to changes in the speaker's rate, volume, force, pitch, and emphasis, the discriminative listener can detect both small

and major differences in meaning. Small clues can strengthen relationship listening. Small differences in sound can enhance appreciative listening. Sensitivity to pauses and nonverbal cues allow critical listeners to more accurately judge not only the speaker's message, but the intentions of the message as well. There are three skills to consider about **discriminative listening**.

1. *Hearing ability.* Obviously, for people who do not hear well, it will be difficult to discriminate among sounds.
2. *Awareness of sound structure.* Listeners that understand the structure of the language being used for the message will have an advantage in discriminative listening.
3. *Ability to integrate nonverbal cues.* Words do not always communicate true feelings. The way they are said or the way the speaker acts, may be the key to **understanding** the true or intended message.

Effective listening, whether informative, relational, appreciative, critical, or discriminative, requires skill.



Barriers to Effective Listening

In order to become a better listener, it is important to understand the barriers that can get in the way of effective listening. Once you understand these barriers, you can work to overcome them.

U.S. MARINE CORPS. JROTC
Category 3—Personal Growth and Responsibility
Skill 4—Written and Oral Communication

- *Laziness.* Effective listening can be hard work.
- *Internal distractions.* Sometimes we have a lot on our minds and it is hard to concentrate on what someone else is saying to us.
- *Past relationships.* Both a poor and an excellent past relationship with the speaker can affect how you listen.
- *Lack of trust.* Believing that the speaker has betrayed your trust or that the speaker does not have your best interests in mind is a barrier.
- *Lack of self-confidence.* If the speaker does not sound confident, the listener has a harder time staying focused.
- *Prejudice.* Prejudice can effect both how we hear the speaker as well as how we receive the information.
- *The “halo” effect.* If the speaker has an association with someone or something we already like, we are much more likely to be receptive to the speaker as well as the information. We may not question what we should question.
- *The “horns” effect.* If the speaker has an association with someone or something about which we have negative feelings, we may not listen the way we should.
- *External distractions.* Sometimes there are a lot of things going on in the same location where you are trying to listen to the speaker.
- *A different level of power between you and the speaker.* Either you may have the authority, or the speaker may. Either way, it can impact how you listen.
- *Gender preferences.* You may have different expectations because of the gender of the speaker.
- *Emotionality on the part of the speaker.* If the speaker gets caught up in the emotional issues around the topic, it may distract you from hearing the real message.
- *Prejudging the message before the entire message has been delivered.* Sometimes a speaker will say something at the start of a speech or conversation that may distract you from effectively listening to the rest.
- *Allowing personal characteristics of the speaker to get in the way.* If the speaker was dirty or smelled, for example, you might not hear everything that is said.
- *Not caring about the speaker.* Being indifferent to the person can affect how well you pay attention to the message.
- *Interrupting.* Sometimes the listener is so excited about an idea he or she wants to share, that the listener does not wait for the speaker’s thoughts to be completed. This distracts both the listener and the speaker.
- *Trigger words.* Some words evoke an emotional response that prevents effective listening. These words are distracting because they make you concentrate on something else besides what is being said. If a speaker uses the word “lottery,” your mind might wander to untold riches. Words like “homework” or “test scores” may also distract you.
- *Delivery style.* Sometimes the way the speaker delivers a message can be distracting. The speaker might have a very monotone voice, or may stutter. Some people continuously put in verbal pauses like “uh” or “you know.” Any of these things may cause you to concentrate more on the delivery than the content.



How to be an Effective Listener

There are many guidelines that will help you to become a more effective listener. Most involve listening “actively” while others speak.

- *Find an area of interest.* Listen with a purpose. Be interested. Try to organize what you hear.
- *Judge content, not delivery.* Do not stop listening because the sender does not meet expectations. Listen to the words. Look for the message.
- *Hold your fire.* Do not get over-stimulated by the message. Do not react until the message is complete. Keep your emotions in check. Do not interrupt because you believe that what you have to say is more important or more correct. There will be time for you to react later. The speaker may surprise you and wind up saying what you want to say.
- *Listen for ideas.* Focus on the person’s central ideas. Do not get bogged down in the details. Try to listen at a higher level. Listen for new knowledge or concepts.
- *Be flexible.* Vary the ways in which you attempt to remember the information. Concentrate on finding the best way to learn the information.

- *Work at listening.* Establish and maintain eye contact. Acknowledge understanding. Stay tuned-in.
- *Resist distractions.* Concentrate on the speaker. Tune out other things that may be going on. Turn off the things you can control, like the TV or the radio. Try not to do several things at the same time. Focus on the sender.
- *Exercise your mind.* Challenge yourself to listen totally. Try it for a short time. Then make it longer and longer. See if you can listen to an entire presentation without losing concentration.
- *Keep your mind open.* Communication efficiency drops to zero when we hear certain trigger words, such as communist, Democrat, or Republican. Everyone has these words that evoke an emotional response. Effective listeners are aware of keeping their convictions and emotions in check.
- *Capitalize on thought speed.* Most of us talk at 120 words a minute. Our thinking speed is about 500 words a minute. That gives us a lot of spare time while a person is speaking to us. Poor listeners let their minds wander. Good listeners think about what is being said by anticipating the point, summarizing, weighing evidence, or looking for nonverbal clues.

Conclusion

So now you know the parts of the listening process. You know there are various types of listening. You have read about barriers to effective listening and tips for overcoming those barriers. Use this information to improve your skills and become a better listener. Remember – improved listening involves work, but the results are well worth the effort.❖

Becoming a Better Speaker

PURPOSE

This lesson will explain and demonstrate effective speaking techniques and provide methods for becoming a better speaker. You will learn how to overcome nervousness in public speaking, the six major categories of speeches, and the purpose and benefits of impromptu speaking. You will learn tips to improve your speaking skills through preparation and concentration.

“The human brain is a wonderful thing. It operates from the moment you are born until the first time you get up to make a speech.”

Howard Goshorn.

Introduction

Most individuals spend seven out of every ten waking hours communicating, three-fourths of their communication being by speech. The average person speaks some 34,020 words a day. That is equal to several books a week, more than 12 million words a year. With all that speaking, the likelihood of you being asked to give a speech is high.

When you were younger, being the center of attention was probably fun. Now that you are older, you are probably much more concerned with your appearance and what people think of you. You may be much more nervous about **public speaking**. With the right knowledge and practice, you can minimize this **nervousness**.

Speeches are not made alone in a room. When you give a speech, there is always an audience. You and the audience have a two-way relationship. You “give” the speech to the audience. In turn, the audience gives you their attention and reaction, called feedback. The advantage of oral communication is that it is a face-to-face process of mutual give and take.

At some point, you will be asked to speak in front of your class, at a family gathering, at a club group, or some other public environment. Perhaps you have already experienced these situations. If so, you know that being nervous can be the hardest hurdle to overcome.

Coping with Nervousness

Recent studies show that speaking in front of a group is by far the greatest fear of most people. It ranks ahead of the fear of dying, riding in an airplane, or failure in other areas of one’s personal life.

You have probably already had to talk in front of a group of people. You may have felt one or more of the common symptoms of nervousness, including:

- Shaking knees
- Dry mouth
- Quivering voice
- Stomach pains
- Loss of memory

One of the most important concepts on which you should **focus** when you are nervous about speaking in public is that you are not alone. Whatever group you are facing, look around and

realize that you have something in common with everyone there. Every person you see has been, or will be, in your situation at some time. In many cases, such as classroom speaking, you are all members of the same group.

“There are two types of speakers: those that are nervous and those that are liars.”

Mark Twain

Another **coping strategy** to deal with nervousness is to realize that you look more confident than you actually feel. Think about all the newscasters you have seen on television. Many of them have said that they feel “stage fright,” yet it is rarely noticeable. Look how many instructors must stand before a classroom and keep the attention of their students. For many individuals, being “in the spotlight” is their profession or career. For other individuals, presenting a speech is an occasional event, such as in speech classes. For everyone, feeling the symptoms of nervousness is ordinary, but it rarely shows.

Keep in mind that your listeners are there to hear what you have to say. Assume they are a friendly crowd. They are not “out to get you.” They are waiting to learn some interesting information.

Another important point to remember is to **concentrate** on your speech content. Do not concentrate on how you are saying it. If you are discussing a subject in which you are interested, the audience will perceive this. If you are more focused on your gestures and your emphasis on certain words, both you and the audience will be distracted.

Be aware of your nervousness before you begin and deal with it. Take some deep breaths and perhaps even do some stretches. Give yourself some time to collect your thoughts.

The best way of all to overcome nervousness is to know that you are prepared. Proper preparation and rehearsal can help to reduce fear by 75%. Practice your speech in front of a mirror. Try to practice enough to minimize using your notes. If you know your subject very well, and are solidly prepared, you will balance your nervousness with a strong feeling of confidence. The audience will see your level of confidence.

Coping Strategies

To review, here are some strategies for coping with and overcoming nervousness:

- Look at the audience and know that they all feel nervous when giving a speech.
- Remember that the audience is there to hear what you have to say.
- Concentrate on the subject.
- Keep in mind that your nervousness does not show.
- Prepare, prepare, prepare.
- Practice, practice, practice.
- Breathe deeply.

Tips for Presentation

After you have gathered the necessary information for your speech, you are ready to present it. When you stand before your audience, remember the strategies for dealing with nervousness. Take a few seconds, breathe deeply,

and begin your presentation. Proper breathing techniques can reduce fear by 15%.

Remember to be yourself. While you are in front of the audience, think positively. Know that the audience is there to learn and listen.

Establish eye contact with members of the audience. Some members of the audience may not return the eye contact. The solution is to establish eye contact with the individuals who are returning your interested look. Remember, this is the way to begin talking *with* your audience and not just *to* them. You are communicating with both your words and your eyes.

When you are giving a speech, you should not read from your notes. Only glance at your notes occasionally, to be sure that you are following the outline and format of your speech.

Try to avoid a lot of body shifting. The movements and gestures you make can be very distracting to the audience. Shuffling your feet or scratching your ear will cause the audience to lose concentration.

Also avoid those interrupting pauses such as, “Uh,” “You know,” “I mean,” “Well,” and “So.” Adding these phrases is a very common habit for speakers. It can also be a hard habit to break, and one that will take some effort and concentration.

Everyone makes mistakes when they are speaking. If you accidentally say a wrong word or you suddenly lose track of where you are, do not panic, but attempt to smile. Smiling through your fumbles tells the audience that although you made a slight mistake, you are still in control of the situation. Correct it, if it is an important point. If it is not, disregard your blunder and continue with your presentation. Go a little more slowly and take your time, maintaining your concentration.

What is equally important in giving a speech is concluding it. When you are finished, do not rush back to your seat. Be professional and ask if anyone has any questions. Look around with composure and if there are no questions, politely say, “Thank you” and go sit down. However, if there are questions, answer them as well as you can. If the information has already been covered in the speech, do not give an extensive explanation. Be brief. Remember, you are the expert on the subject.



Basic Speech Structure

All types of speeches basically have a beginning, middle, and an end. They use a standard format for organization. You tell the audience what you are going to say, you say the main part of your speech, and then you tell the audience what you told them.

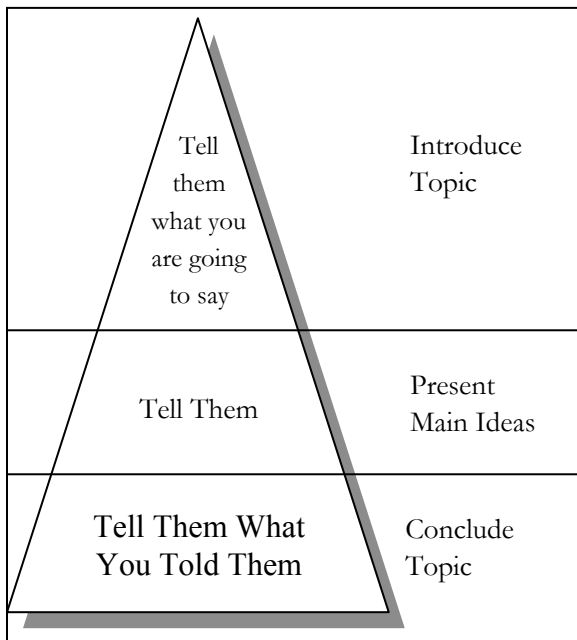

While preparing your speech, you will follow the six basic steps to effective speech writing.

1. Analyze the purpose of the speech and the audience.
2. Conduct research and gather information.
3. Support your ideas
4. Organize all the material.
5. Draft and edit the speech.
6. Practice and get feedback.

Types of Speeches

There are several major categories of speeches:

- **Informative**
- **Persuasive**
- **Actuating**

- **Argumentation**
- **Entertaining**
- **Impromptu**

The purpose of each speech varies, depending on what you are attempting to accomplish as a speaker.

The Informative Speech

The speech to inform does exactly what it says. It informs or tells the audience about something. It delivers information so that the audience can grasp and remember important data about the subject. The goal is for the audience to accomplish understanding of the subject. An example is a presentation on how to disassemble and reassemble the M14 rifle.

The Persuasive Speech

The speech to persuade attempts to change the audience's minds and/or behavior toward something. An example is persuading listeners not to "drink and drive."

The Actuating Speech

The speech to actuate is a motivating speech like the persuasive speech, but the difference is that the speech to actuate calls for immediate action. For example, suppose your school principal announces that the school team needs to be encouraged about a big upcoming game. Then, the resulting action may be in the form of a school "pep" rally.

The Argumentation Speech

The argumentation speech must be structured as most other speeches. It must rely on logical appeals. This type of speech is also known as a kind of reasoned persuasion. Many debates in social and political fields are based on this kind of speech. Another common example is the closing

argument an attorney makes during a courtroom trial.

The Entertaining Speech

The speech to entertain is used to relay a message in an entertaining manner. Humor plays an important part in this speech. For this reason, the entertaining speech can be difficult to present because humor is of a personal nature. Everybody is different as far as what makes them laugh. But, if an entertaining speech is presented well, it can be very effective. When someone is being honored, very often another person will make a humorous speech about the honoree, perhaps telling a funny story about the person.

The Impromptu Speech Builds Self-Confidence

The impromptu speech is something a little different, since most impromptu speeches are presented without elaborate preparation. The word “impromptu” means “to do something without preparation or advance thought – off-hand.”

“It usually takes me more than three weeks to prepare a good impromptu speech.”

Mark Twain

Building Self-Confidence

Practicing

For beginners, impromptu speeches are necessary in helping the individual to gain **self-confidence** and the ability to “think on your feet.” Impromptu speaking is an effective training device. The more practice you have in giving impromptu speeches, the better qualified you will be to deliver prepared talks. Suppose your

instructor asked you to stand up and give an impromptu presentation on why you decided to join the MCJROTC. Pause for a few seconds before you begin and collect your thoughts.

Benefits

If you sound smooth and polished when giving an impromptu speech, both you and your audience will be impressed. By practicing, you will be capable of putting your thoughts into logical order. You will talk clearly and convincingly to your audience without any notes. Remember that your audience will not be expecting an elaborate speech, but they are there to hear you tell them something of interest.

Techniques

The best way to be prepared for the “unprepared” is to stay up-to-date in your field of interest. Clipping and saving articles and reading newspapers or news magazines are ideal ways to do this. Communicating with people who share your area of interest also helps you broaden your understanding.

Imagine a storehouse in your mind where you will file these different bits of information. When you stand to speak “impromptu,” you will be prepared to pull out the needed data from your mental file. For example, reading up on MCJROTC and discussing your future in it with your instructor will add to your ability to discuss this subject with your audience.

One way to organize your thoughts for an impromptu speech is to use a “Past, Present, Future” format. Speak first about the past of the subject, such as how the MCJROTC unfolded in the beginning and what has been done to increase the number of cadets. Then, speak about the organization and the role it plays today by considering what is happening now and what kind of learning takes place. And next, contemplate the

future. Consider what things may change, what improvements may be made, and where MCJROTC may be ten years from now.

Another procedure to use in your presentation is to support your ideas with examples or statistics. In addition, try to find experiences from your past that will add to your speech and make your points believable. For example, suppose your instructor asked you to make a speech about seatbelts and whether or not you favor a mandatory law for wearing them. You could talk about how you feel wearing seatbelts is a wonderful idea. But, most people already know that. You would not be telling them anything they did not already know. Instead, state why a mandatory law is a good idea by attaching it to something you have seen, heard, or read in the news. You could say something like, “I read in the newspaper the other day that a family of four survived a car accident because they were wearing seatbelts. The report said that if it were not for that, they would have been thrown violently from their car. More than likely, they all would have died.”

Also, always be sure to take your time. Of course, some situations require a minimum or maximum time. Remember that you will need to collect your thoughts and to wait for the audience to quiet down. Most important, do not rush head-on into your presentation. Concentrate on what you are saying and what you want to say.

Finally, try to stay on the subject. Keep focusing on the topic in your mind so that your examples or stories are extended from that basis. Practicing at home will help you be prepared in the classroom or anywhere the impromptu situation arises. Pick any object in your room or any story in the newspaper. Contemplate what you could say about it. Speak about the item while timing yourself.

Tips for Impromptu Speaking

Remember these techniques to improve impromptu speaking:

- Stay knowledgeable on a variety of topics.
- Try a format such as “Past, Present, Future.”
- Support your ideas with examples or statistics.
- Add personal experiences.
- Do not rush. Collect your thoughts.
- Concentrate on what you are saying.
- Stay on subject.
- Practice giving impromptu speeches.

Conclusion

Speech is the most widely used medium of communication. The main purpose of any speech presentation is to deliver clear and specific ideas to the listeners. Practicing the impromptu speech is an ideal way for many individuals to gain self-confidence and the ability to communicate “on their feet.”

Although fear of speaking is common, studies show that one of the most admired qualities in others is their ability to speak in front of a group.

Like writing, speaking is a skill. Once you grasp the basics, the rest is practice, polish, and style. You may be embarrassed by initial mistakes, but you will survive. Few of us will become great speakers, but all of us can become more effective speakers if we take the time to practice the basics.



Introduction to Career Preparation – The Portfolio

PURPOSE

This lesson provides an opportunity for cadets to begin career preparation for their future. It introduces the portfolio as a career preparation tool that will increase cadets' chances for success. It describes what a portfolio is, explains the importance of creating and maintaining a portfolio, and identifies portfolio items. Cadets will also create their own portfolio.

that promotes what you want others, specifically future employers and schools, to know about you.



Introduction

What do you want to become? What are you suited to become? What do you need to do to prepare? These questions and many more like them are what you must try to answer in order to prepare for your future. The better you prepare the greater your chances of achieving success and doing something that you enjoy. This lesson will focus on the portfolio, its importance, and its development and maintenance.

What Is a Portfolio?

A portfolio is a file that contains an organized collection of student work based on personality, goals, and aspirations. It provides insight and information on a student's personal self and a student's achievements and/or growth over time. It presents an in-depth picture of the student's skills and competencies. It also provides a means to reflect on important areas of life development and the value of education on future lifestyle and career choices. It contains information

Why Create a Portfolio?

There are many good reasons to develop and keep a career portfolio. A portfolio is tailored to meet your needs and requirements. It serves as your record of achievement. It is also designed with colleges, potential scholarships, and future employers in mind. It will:

- Serve as an ongoing record of your completed work. Contain copies of good work from all of your classes, including information on projects that you are involved in that will be ongoing from year to year. Provide you with a historical record that you can apply to other projects.
- Allow you to evaluate and see your improvement and growth, including how much you have done over the course of a nine-week period, semester or quarter, this year, or all the years of your high school experience.
- Serve as evidence of your accomplishments, even if you transfer from one school to another.
- Update your parents on your progress.

- Furnish you with a record of areas in your growth and development that may require more work.
- Help you with the application process for future jobs and/or enrollment in colleges or universities.

Creating Your Personal Portfolio

The following information will show you how to create a career portfolio that suits your own personality, goals, and aspirations. As you begin to use it, you will be able to see how important pieces of your life fit together so that you can feel confident and optimistic about your future. During its development and use, we encourage you to talk with your parents, instructors, counselors, and other supportive people in your life. They can best advise you on the type of information that you should save in your portfolio – information that promotes what you want others to know about you.

By now, you may be able to pause and reflect on certain things about which you have learned, your likes and dislikes about them, your

personality, your dreams for yourself, the things you wonder about, the things that frustrate you, and especially the things that you like most about yourself. Therefore, when creating your career portfolio, apply these thoughts and reflections to the areas of:

- *Self-knowledge/self-analysis.* Include self-concept, interpersonal skills, and growth and development.
- *Your life roles.* Include acceptance of self and others, family influences, and career connections.
- *Past, present, and future educational development.* Include learning styles and assets, thinking skills, and work habits.
- *Career exploration and planning.* Include internships, community service, and thoughts about a future career.

If your school or JROTC unit has not chosen a specific portfolio, you can easily create your own using an ordinary file folder. Place identifying information on the outside cover.

OFFICES HELD
MEMBERSHIP IN STUDENT ORGANIZATIONS/CLUBS
EXTRA CURRICULAR ACTIVITIES
REPORT CARDS
SPECIAL HONORS AND AWARDS
LETTERS OF RECOMMENDATION
TEACHER COMPLETED REPORTS/EVALUATIONS
PROJECTS
COPIES OF GOOD WORK
TABLE OF CONTENTS
Social Security # (Optional) _____ Date of Birth _____
Driver's License # _____ Graduation Date _____
(Address) _____
() _____
(Telephone #) _____

Basic Portfolio Requirements

Your parents, instructors, and/or school counselors can help you decide what should go inside your portfolio. Initially, you may elect to include a few rough drafts, especially if your instructors think you should save them. The headings on the files inside the sample folder shown above are just a few documents that you may want to place in your portfolio. Then, as you progress through high school, there will be other documents that you'll want to include in your portfolio – documents pertaining to job skills, work experiences, standardized exam results, job applications, resume, college applications, financial aid forms, and self-analysis/skills surveys. However, no matter what you put into your portfolio, you should review the entire portfolio contents at least three times a year and remove anything that you no longer want to save.

Although, portfolios will vary based on the needs of the individual and the audience, there are some basic requirements common to all portfolios. They are:

- A personal cover page
- A table of contents
- A personal statement
- A resume
- Letters of reference – as many as possible
- Transcripts (optional)
- Samples of your schoolwork from different subject areas (include why each sample is significant)
- References and contact information

References and contacts are extremely important. The names, addresses, and phone numbers of references and contacts are normally developed over many years. Fellow JROTC

cadets; other classmates; teammates; your parents' friends; your friends' parents; people you met at camp, church, or the mall; or acquaintances made while traveling are contacts who may become an important part of your future. They may be future clients, customers, colleagues, or employers.

Evaluation of Your Portfolio

A portfolio is not complete unless you evaluate it thoroughly. Remember, the portfolio represents you. So, here are some questions you should ask yourself to ensure that you have developed a quality product.

- Are the required documents included?
- Have you edited it to make sure that there are no errors?
- Is the portfolio neat and organized?
- Is the portfolio labeled properly?
- Is it pleasing to the eye?
- Does it represent you as a person?

<i>Portfolio Checklist</i>	
<input checked="" type="checkbox"/>	Are the required documents included?
<input checked="" type="checkbox"/>	Has it been edited for correctness?
<input checked="" type="checkbox"/>	Is the portfolio neat and organized?
<input checked="" type="checkbox"/>	Is the portfolio labeled properly?
<input checked="" type="checkbox"/>	Is it pleasing to the eye?
<input checked="" type="checkbox"/>	Does it represent you as a person?

Conclusion

Being successful is often determined by your ability to organize time and goals into an effective and realistic plan. Setting a goal and identifying ways to attain it leads to choosing the best method to solve it. Listing the steps involved to complete the goal lets you prepare for changes that might arise. Following through finishes the plan and achieves the goal. Evaluation of the solution lets you see how you performed.

If you have not already started on a career portfolio before this school year, start now. Create a portfolio that is responsive to your future needs and interests. To be complete, it should contain documentation on your goals, educational development, career exploration and planning, and self-analysis.

Finally, do not put off making contacts, and make them as often as you can. Keep the name, address, and phone number of these contacts in your address book, which should be included in your portfolio. ❖

Introduction to MCJROTC Leadership Education

PURPOSE

This lesson identifies the requirements for successful completion of the MCJROTC leadership education course. It provides MCJROTC history, its objectives, and the curriculum.

Introduction

It may be laid down as a primary position and the basis of our system, that every citizen who enjoys the protection of a free Government owes not only a proportion of his property, but even his personal services to the defense of it...

General George Washington.
Letter to Congressional Committee, (1783).

The United States formed its first “reserve” forces under the Militia Act of 1792. Not until 1903, when the National Guard was formed, did the country become serious about military readiness. Five years later, a Medical Corps reserve, as opposed to the “state-owned” National Guard, was formed and the Army Reserve followed in 1912. The Navy Appropriations Act of 1916 allowed the Marine Corps to exceed its regular and wartime manpower ceilings. By the close of World War I in November 1918, over 6,000 officers and men of the Corps were classed as “Reserves.” Under this category, the first women Marines were recruited in August 1918. By the end of the war, there were 305 Marine Reserves (female) serving as clerks, chiefly in HQ Marine Corps. Under the

1925 legislation, the USMC’s reserve personnel were recognized.



History of the MCJROTC

The **Junior Reserve Officers’ Training Corps (JROTC)** program is nearly as old as the United States of America itself. In 1783, the honorable George Clinton, a prominent statesman, who had been elected to six terms as “Governor of New York,” introduced an idea that called for the inclusion of military instruction at one civilian college in each of the states. Under Mr. Clinton’s plan, students, after completing their degree and a prescribed course of instruction in military sciences, would be commissioned as a junior military officer and serve a short stint of active military service in one of the branches of the Armed Forces. Upon returning to civilian life, they would form a trained officer corps that would be held in *reserve* and remain available in time of national emergency if required. A system of inspections and regular reports was to give coherence and uniformity to his officers’ education program.

In our studies we must remember the circumstances surrounding this idea of an ROTC.

The nation had just won its independence from Great Britain after a long, and hard-fought rebellion. The Continental Army was poorly equipped and often poorly trained, it narrowly outlasted the most powerful country and military in the entire world. Mr. Clinton did not want to chance another such calamity; he wanted America to have a base of trained and educated officers that could be called upon when needed. Unfortunately, his plan never came to be.

The University of Georgia claims to have hosted on-campus military instruction in early 1807. In the early nineteenth century, Georgia State law required all male citizens between the ages of 18 and 45, to “assemble five times a year for a military muster.” Because most of the university students fell into this group, they attended on campus drills. The purpose of this training was not to prepare its recipients to receive a commission into the armed forces, but rather to allow them to fulfill their state-mandated military obligation to the state.

Modern Reserve Officers’ Training Corps can trace its heritage to the first recorded civilian instruction of higher learning in the United States that included military education in its curriculum. In Vermont, 1819, Captain Alden Partridge, a former superintendent of the United States Military Academy at West Point, founded the American Literary, Scientific, and Military Academy, now Norwich University.

Captain Partridge’s educational experiment was driven by the ideal of the citizen soldier. He wanted officers who would be “identified in views, in feelings, and in interests, with the great body of the community.” His vision of the college was to reconcile the efficiency and discipline demanded by a regular army with the republican values and popular sentiments inherent in the militia system.

Between 1819 and the Civil War, a number of other essentially military schools were established. Lafayette College, Oak Ridge Academy, and Kemper and Marion Institutes were private institutions, while the Virginia Military Institute and the Citadel were state-supported schools.

At the Citadel and the Virginia Military Institute the civilian soldiers’ ideal was not as important as at Norwich. Their founders were bound up with the Southern military tradition and a practical need to provide a management education for the sons of the planter aristocracy.

In addition to military schools of the period, a number of civilian institutions hosted military instruction during the first half of the 1800s. St. Johns College in Annapolis, Maryland, began in 1826. The University of Tennessee and Indiana University were reported to have it as early as 1840; and William Tecumseh Sherman University introduced the military training in the state of Louisiana in 1859.

The University of Virginia had military training for a relatively short time in the 1820s and 30s beginning when Thomas Jefferson founded the University in 1825. He made tactical drill and training mandatory hoping to produce qualified officers for a national militia. Jefferson foresaw military education developing into a recognized academic field of study. Unfortunately, within a decade of its activation the University’s corps of cadets was disbanded after a confrontation with the university’s faculty. This same scenario was seen throughout the nation’s schools 140 years later.

The Morrill Act of 1862

At the start of the Civil War, the Union found that it did not have nearly enough trained officers to lead the Armed Forces. The 20,000

officers initially required, overwhelmed the 1,500 West Point and Norwich graduates available for service. Most **leadership** in the Army was via appointments of politically connected novices or election within the companies. The officers' crisis required Congress to develop some provisions for the education of civilian-soldier military leaders.

Representative Justin S. Morrill of Vermont, a friend and neighbor of Captain Alden Partridge, introduced legislation, which came to be known as the Morrill Land-Grant College Bill of December 1861. The proposed act gave every state 30,000 acres of public land for each of its members of Congress. Funds generated from the sale of the land were to be used in establishing and sustaining at least one agricultural and industrial college in each state. Specifically the income was for:

...the endowment, support, and maintenance of at least one college where the leading object will be, without excluding other scientific and classified studies and including military tactics, to teach such branches of learning as is related to agriculture and the mechanical arts, in such a manner as legislatures of the States may respectfully prescribe, in order to promote the liberal and practical education of the industrial classes in the several pursuits of professions in life.

President Abraham Lincoln signed the Morrill Act on July 2, 1862, the day after General George McClellan's crushing defeat at the Seven Days Battles.

Soon after the passage of the Morrill Act, land-grant colleges began to be endowed and military instruction became part of many college curriculums. Professors with military wartime experience headed most college military programs, while still performing their full-time duties in

other fields. The training offered was the most basic kind and left much to be desired. In most cases the training consisted exclusively of drill in its most rudimentary form. Not much else could be expected since the program had no defined objective, no authorized provisions for uniforms and equipment, no syllabus, and no prescribed outline of courses. Even if the training had been better, the Union officers' procurement problems would not have been alleviated since the Morrill Act came too late to have played a significant part in the course of the war.

In the post-Civil War era, Congress enacted a number of measures designed to improve the collegiate military training and encourage its growth. In 1866 it authorized the President to detail 20 officers to teach military science at land-grant colleges. In 1870, small arms and equipment were authorized to be issued. In 1880, retired officers were granted permission to teach. In 1888, War Department assistance was made available to schools outside the land-grant community, to include high schools. Finally, in 1893, legislation raised officer authorizations for detached college duty to 100.

By the turn of the century, some 42 institutions, including state and private colleges, had established Departments of Military Instruction. Among the land grant institutions, the traditions of military training took the firmest root and the concept of citizen-soldier education became embedded. At most land-grant colleges, one year of military training had been made compulsory by 1900.

The National Defense Act of 1916

For the next several years, there was no uniform policy for land-grant colleges as to the precise nature of "military tactics" training prescribed by the Morrill Act. In 1916, Congress passed the National Defense Act authorizing the

War Department to establish Reserve Officers Training Corps (ROTC) units in schools and colleges. This act standardized the policy relating to ROTC and the land-grant colleges yielded to pressure and the military training was made compulsory for all first and second years male students.

The Junior Reserve Officers' Training Corps (JROTC), like its senior counterpart ROTC came into being with the signing of the National Defense Act. The act authorized high schools the loan of federal military equipment and the assignment of active or retired military personnel as instructors on the condition that they followed a prescribed course of training. At its inception, the JROTC course consisted of a minimum of three hours of military training per week for a period of three years. Any JROTC graduate who completed this course of military instruction was authorized a certificate of eligibility for a reserve commission to be honored at age 21. This provision was phased out after World War I as the need for reserve officers dwindled. Unfortunately, when the United States entered World War I, few resources were available for the JROTC. Between 1916 and 1919, the War Department established only 30 JROTC units.

Federal support for and assistance to the JROTC program remained limited between the world wars. Due to funding constraints and a lack of enthusiasm on the part of the War Department, the number of JROTC units increased only gradually during 1919 to 1939. By 1929, 295 JROTC units were in operation, not impressive for a program that had been in existence for two decades.

There are many reasons for the limited growth during these years. Many high schools scheduled military classes and training at inconvenient and undesirable times. Some

restricted JROTC instruction to the lunch hour while others accorded it time in the late afternoon or early evening. Shortages of space and resources resulted in student participation and enthusiasm dropping. If his facilities were only inadequate, a Professor of Military Science could count himself as fortunate; some instructors did not even have a desk to operate from.

In addition to a lack of support from the secondary education institutions, the JROTC found itself competing for qualified students from another high school training program called the National Defense Cadet Corps (NDCC). The main difference between the programs centered on the amount of support they received from the federal government. Whereas JROTC units received instructors and uniforms from the War Department, NDCC programs did not. Weapons and a few training aids were the most NDCC schools could expect in the way of material assistance. Many NDCC units wanted to join the JROTC program but were unable to do so due to the lack of funds to support JROTC expansion.

Because the supervision and funding of NDCC units rested solely in the hands of local school authorities, the War Department's ability to exert its influence over them was limited. As a result, the War Department displayed less interest in the NDCC than it did the JROTC. As a result the NDCC took on second-class status and never attained the degree of military acceptance the JROTC had. By 1939, NDCC had only 34 programs in operation.

Post–World War II

The two decades following World War II were austere times for JROTC. Due to funding and manpower constraints, the Army froze JROTC growth. This resulted in a boom for the NDCC, which did not rely on federal funding. As schools on the waiting list for JROTC programs

realized that they would not be allowed a unit, they turned to the NDCC program to fill the void. Seventy-five NDCC units were established and by 1963 there totaled 109 units nationwide.

The first significant increase in JROTC units occurred when Robert S. McNamara became the Secretary of Defense in 1961. Mr. McNamara turned intense scrutiny on the program by questioning the \$4.7 million needed annually to run the program and the 700 active duty personnel needed as instructors. He felt the cost was excessive for a program that, despite its title, produced no officers and made no “direct contribution to military requirements.” Mr. McNamara’s solution to this problem was to convert JROTC units into NDCC units. His reasoning was based on the fact that the cost of the entire NDCC program was less than \$100,000 per year to administer and hence a substantial savings would be realized. The FY 1964 budget contained no provisions for funding the JROTC, with the exception of those units located at military schools. Some money was set aside to convert JROTC units into NDCC units but very little was actually allocated.

Mr. McNamara failed to realize the number of supporters for the JROTC program both in and out of Congress. Letters and telegrams flooded his office and those of members of Congress insisting the JROTC was an irreplaceable national asset and the effect it had on juvenile delinquency alone was worth its cost. JROTC supporters in the House of Representatives introduced legislation proposing the expansion of the program from the existing 254 units to a maximum of 2,000 units, and extension to both the Navy and Air Force (prior to this, the Army was the sole service represented in JROTC).

After an exhaustive survey of secondary school officials, community leaders, and parents, an 11-member **Department of Defense (DoD)** commission determined that, although the JROTC produced no officers and served no direct military purpose, JROTC was important and should expand nationwide. The Department of Defense realized it could not block the decision to maintain the JROTC and could not stop its expansion; instead, they decided to guide its expansion as best they could. The most important decision in that respect was the elimination of the 700 active duty members and their replacement by military retirees as JROTC instructors. Unfortunately for the NDCC, the commission recommended the elimination of the program due to the lack of resources and Army support. By 1973, only 17 NDCC units remained in operation.

On October 13, 1963, President John F. Kennedy signed Public Law 88-647, the ROTC Vitalization Act of 1964. It required the services to increase the number of JROTC units and to achieve a more homogeneous geographical distribution of units across the nation. Specifically, Public Law 88-647 requires:

The Secretary of each military department shall establish and maintain a Junior ROTC, organized into units, at public and private secondary educational institutions which apply for a unit and meet the standards and criteria prescribed pursuant to this section. Not more than 200 units may be established by all of the military departments each year beginning with the calendar year 1966, and the total number of units that may be established on the date of enactment in this section, may not exceed 1,200. The President shall promulgate regulations prescribing the standards and criteria to be followed by the military departments in selecting the

institutions at which units are to be established and maintained and shall provide for the fair and equitable distribution of such units throughout the Nation, except that more than one unit may be established and maintained at any military institute.

Of the 1,200 units authorized, 275 were allocated to the Secretary of the Air Force, 650 to the Secretary of the Army, and 275 to the Secretary of the Navy, of which 52 were made available to the Marine Corps.



On July 14, 1974, Congress further expanded the JROTC program to a maximum of 1,600 units, 200 to the Army, 100 to the Air Force and 100 to the Navy, of which the Marine Corps received 30. Due to the lack of funding, actual establishment of new units was limited to only 20 by 1980.

The most recent expansion of the JROTC program occurred on August 24, 1992, when Congress expanded the program to 3,500 units, resulting in the Marine Corps reaching a total allocation of 200 units. This dramatic raise was a direct result of General Colin Powell successfully lobbying for the expansion as a result of two significant events; the recent Los Angeles riots and the victory in Operation Desert Storm. General Powell believed that the riots underscored the lack of opportunities for teenagers in economically disadvantaged areas and, since the American people were once again proud of their

American military, he wanted to ride the momentum to help high school youth, particularly those in troubled inner cities. Currently the JROTC program is awaiting another expansion. Approved by Congress and awaiting the President's signature, this new expansion, targeted at rural America and small towns, will bring the Marine Corps total number of schools to 220.

Today's Marine Corps JROTC is a composite of the lessons learned throughout the JROTC programs of the past. The modern JROTC program capitalizes on its mission to provide a course of leadership education designed to develop informed citizens, strengthening **character** by the teaching of discipline, and developing the understanding of the responsibilities of **citizenship**.

Purpose of MCJROTC

The purpose of the Marine Corps Junior Reserve Officers' Training Corps program, commonly referred to as "Junior ROTC," is to instill a value of citizenship, service to the United States, personal responsibility, and a sense of accomplishment. It does not seek any particular commitment to the military. The current legal basis for Junior ROTC is Section 2031 of Title 10, United States Code. That section is implemented by the Department of Defense. The governing directive, 1205.13 "ROTC Program for Secondary Educational Institutions," is dated June 16, 1982.

The Department of Defense funds and sponsors JROTC through the Secretaries of the Military Departments. MCJROTC is funded and sponsored through the Office of the Secretary of the Navy. Legally, the JROTC program offered in a high school must be no less than three years and no less than 96 hours of instruction each year. Usually, each year contains 180 hours of leadership instruction and application. The

program may extend over four years. Your program meets these requirements. Similar programs are conducted nationwide by the other three military services.

There are seven major objectives of the MCJROTC. First, the program aims at developing informed and responsible citizens. The more you learn in the MCJROTC, the more likely you are able to function effectively in a career in the community and in family life.

Second, the MCJROTC helps develop leadership. Leadership is the core of the curriculum. If you do well in the MCJROTC, you will likely succeed in leadership roles later in life.

Third, the MCJROTC helps build character through leadership development. You will learn about ethics, leadership, followership, desirable traits, and self-discipline.

Fourth, the program is designed to teach you about the elements and requirements for national security. If you master this knowledge, you will be better equipped to make informed and intelligent decisions. Vital issues will face you and your community, state, and nation in the future. National Security requirements should not be subject to the emotions or unformed judgments of citizens. You must become knowledgeable concerning current events and issues which have a direct effect on your nation and, in turn, you.

Fifth, the MCJROTC is a program in which discipline is stressed. A good leader is one who has self-control and will remain calm and competent in difficult situations. Thus, self-discipline is required.

Sixth, respect for authority is of the utmost importance in any organization and in life, in general. You must learn to respect your peers, superiors, and subordinates. Lack of respect breeds unrest and dissatisfaction. The MCJROTC

will give you the experience in recognizing authority and gaining the respect of others.

Seventh, the MCJROTC will enlighten you to possible career and educational choices.

The MCJROTC Curriculum

There are five subject areas in MCJROTC, called categories, or courses of instruction. They are:

- Leadership
- Citizenship
- Personal Growth and Responsibility
- Career Exploration and Public Service
- General Military Subjects

Each of these categories has distinctive content, but there is frequently an interrelationship between lessons.

Leadership, constituting Category 1, focuses on all aspects of leadership to include leadership fundamentals, traits, and techniques of leading people. You will learn the basic fundamentals of leadership. In doing so, you will learn about yourself and your responsibilities as a member of a team and an organization. You will learn self-discipline. All of the lessons reinforce each other in the development of your leadership skills. Mastery of these skills will help your development of related and advanced leadership skills.

Citizenship is the second category of this program. It is the core of the program and the reason the MCJROTC exists. In accordance with Public Law, its purpose is to instill citizenship values. It teaches you about patriotism, your civic responsibilities and national defense.

Personal Growth and Responsibility, Category 3, focuses on all aspects of your personal growth. It includes physical fitness, health, hygiene and nutrition, social skills, communications, and personal finance. It will introduce you to patterns of behavior that can improve your chances of a long and healthy life. It will help you to develop and/or maintain a healthy lifestyle as well as improve your social and communications skills. During the first year, you will be introduced to the basics. Each succeeding year, you will continue to build upon what you have learned the preceding year.

Career Exploration and Public Service, Category 4, provides you with an opportunity to determine what you want to do with your life. It will provide you with career preparation opportunities for college and the workplace. It will also make you aware of the opportunities for public service at the local, state, and federal levels and the military.

General Military Subjects, Category 5, will introduce you to subjects unique to MCJROTC. You will learn about administration of the MCJROTC program, drill and ceremonies, uniforms, clothing and equipment, customs, courtesies and traditions, rank structure, chain of command, military history, marksmanship, first aid, Interior Guard, land navigation, and the Uniform Code of Military Justice (UCMJ). Drill and Ceremony stresses the teaching of teamwork and cooperation. It teaches working with others to achieve a common goal. The planning and execution of ceremonial events will give you the chance to exercise the leadership and management skills being developed in other categories. The first year teaches the core of drill and teamwork. The second and succeeding years will teach you the details and also provide you the chance to teach teamwork to others.

All of these categories provide the basic foundation for MCJROTC during your first year with increased levels of responsibility in the subsequent years. Remember, you must learn to follow before you learn to lead. In the first year, you will normally serve as a follower of those more knowledgeable than you. As a participant in activities and as a potential leader, you will be learning and following. With patience, self-discipline, and hard work, you will develop and grow. In the second year, you will assume more responsibility and fill leadership roles. By the third and fourth year, you will be senior cadet leaders.

Conclusion

As a member of the MCJROTC, you will be provided great opportunities to develop and grow. You will have an opportunity to practice and apply the concepts taught in the classroom. What will you receive in return for a commitment of one to four years of academic and physical effort in this program? You will become a leader with real-world experience. You see and do things unique to the MCJROTC. You will develop skills, abilities, and knowledge that will serve you for a lifetime. ❖

MCJROTC Unit Organization

PURPOSE

The purpose of this lesson is to make you aware of the organizational elements of a MCJROTC Unit. As a MCJROTC cadet, you should be familiar with the MCJROTC chain of command and organization and the principles inherent in that organization.

Introduction

When a group of people get together to perform a specific task, there must be some form of organization. Otherwise, time and effort are wasted and the mission may not be accomplished. This is true for both civilian and military **endeavors**. In the military and more specifically, the United States Marine Corps (USMC), missions take on greater importance, because they often deal with the defense of the nation. Just as the Marine Corps has organization and structure, so too does the MCJROTC. Therefore during this lesson, you will learn about the MCJROTC **chain of command** and organization.

Most organizations follow the same general pattern. Decisions are made and actions are taken by an executive, or commander. This individual is entrusted with the authority and the responsibility to give orders and to enforce those orders, so that the task is accomplished. If subordinates have more than one commander to report to, organization can break down. If this happens, the chances of the successful completion of the task are lessened. This is why responsibility for a unit is given to a single individual. Within

the MCJROTC unit organization, that individual is the Cadet Battalion Commander.

The main idea behind organization is the effective use of the individual. Wasting labor hours and efforts of subordinates is **detrimental** to the accomplishment of the task. Thus, capable people would be assigned to jobs in accordance with their talents and capabilities. The jobs should provide individuals with training that will allow them to advance to the next highest rank. This encourages them to successfully complete the tasks, which results in positive reinforcement in the form of advancement. The same holds true for members of the MCJROTC Cadet Corps.

Grade and Rank

Each person in a military organization holds a certain rank or grade. Individuals begin as recruits or trainees. As they obtain experience and training, they move up the chain of command to take on responsibilities as leaders. Leaders come in two categories. There are commissioned officers and noncommissioned officers.

Commissioned officers, second lieutenant and up, receive their “commissions” from the President. These commissions authorize them to perform their functions and duties in the military. The commissioned grades are: second lieutenant, first lieutenant, captain, major, lieutenant colonel, colonel, brigadier general, major general, lieutenant general, and general. Second lieutenants, first lieutenants, and captains are known as “company grade” officers. Majors, lieutenant colonels, and colonels are called “field grade officers.” All grades of general are referred to as “general officers.”

Noncommissioned officers (NCOs) are enlisted personnel who have advanced above the first three entry-level positions and placed in positions of authority by the commander of a unit. USMC noncommissioned officer grades are: corporal, sergeant, staff sergeant, gunnery sergeant, master sergeant or first sergeant, and master gunnery sergeant or sergeant major. These NCO/SNCO are placed in command of other enlisted personnel. The senior noncommissioned officer of the Marine Corps holds the title, Sergeant Major of the Marine Corps and is the adviser to the Commandant on all enlisted matters.

Selected individuals may be warranted to perform tasks that require a high degree of training and specialization. These warrant officers rank between the top enlisted grade and the lowest commissioned officer.

In the MCJROTC, cadet rank will parallel the rank of the actual Marine Corps. As a result, cadets will earn cadet rank ranging from enlisted, to officer with the highest rank achievable being lieutenant colonel.

Principles of Organization

There are several principles that must be taken into consideration when establishing an effective command and control system. You must consider the **unity of command**, the **span of control**, and the chain of command.

Unity of Command

Unity of command means that there is only one officer who is responsible for the actions of the unit in question. This is the person who answers for the success or failure of the unit. It follows that it is this person's duty to see that any and all assigned missions are accomplished.

Span of Control

Span of control concerns the number of subordinates who can be controlled or supervised by an individual commander. The number of subordinates a commander can control varies with the type of unit and the variety of functions to be performed. The span of control is greater for units composed of identical elements than for units where the parts are varied and specialized. Other factors that can affect the span of control include freedom of movement, communications, and the number of subordinate assistants available. The range for span of control is between three and eight persons.

Chain of Command

The chain of command varies with the component of command involved. All orders and instructions from higher echelons to lower echelons should be issued through the chain of command. A person or unit can only have one immediate commander. It is from this commander that all orders and instructions are received. By using the chain of command, an individual commander may limit the number of personnel who are directly supervised.

It is the duty of the leader, or commander, to see that the task is completed. This requires the commander to see that the unit has the means necessary to complete the task. To see that this is done, the following three additional factors must be taken into consideration: simplicity, economy, and flexibility.

Simplicity. This factor is necessary for a number of reasons. Simplicity will allow a reduction of high skill levels in training. It will also help minimize problems in supply and maintenance. Employment and deployment of the unit will be **facilitated**. One must be careful,

though, because if this is taken too far, the unit will be unable to perform its functions.

Economy. This involves the equipment of the unit. The equipment that you have on hand should relate to the normal performance of the unit. Any equipment not used on a day-to-day basis should be pooled at the highest possible level. Extra equipment should be requested only on an “as required” basis.

Flexibility. A unit is designed for a specific task. This does not mean that the unit should restrict itself to those tasks. In Korea, in 1950, many transport units and engineering units were forced into combat and infantry type duties as a result of the encirclement by the Red Chinese. These units were able to accept the challenge and be successful. They displayed their flexibility and resourcefulness.

MCJROTC Organization

Military command is exercised through a series of leaders. When a commander wants a specific task accomplished, a subordinate is given an order and that order is passed down the chain of command. This saves the commander much time and trouble. For instance, the commander will give the order to the lieutenants who are the platoon leaders. They will then give it to the sergeants who are the squad leaders. The squad leaders will give the order to their squad members. In this way, the information flows from commanders to subordinates. The series of leaders along which the command follows is called the chain of command. The chain of command extends from the President of the United States (Commander in Chief) to the last private in the last rank.

Your school has a similar chain of command. The county or city superintendent

supervises the principal. The principal supervises the teachers, who supervise you, the student. As a cadet in MCJROTC, you are directly in the chain of command of the USMC. The chain of command from the President to you is illustrated in *Figure 1* on the next page. This illustration shows how you fit into the Marine Corps JROTC chain of command.

Figure 2 on the next page shows the organizational structure of a typical MCJROTC unit. On the level of MCJROTC, you will most often be organized at either battalion or company level, according to the desires of your Senior Marine Instructor (SMI). A battalion consists of two or more companies. A company consists of three or four platoons. Normally, a platoon consists of three or four squads. A squad is made up of a sergeant and eight to twelve squad members.

As a member of a MCJROTC unit, you will earn and carry rank. Your insignias will display your rank and should give you a sense of identity. If you wear your uniform properly and develop the proper attitude about your unit and your duty, it will help you in your development as an individual.

Conclusion

The MCJROTC, like the USMC, has both officers and NCOs as leaders. MCJROTC follows the USMC concepts of unity of command, span of control, and chain of command. Simplicity, economy, and flexibility are important features. MCJROTC units are not only in the USMC chain of command, but also in the school system’s chain of command. ❖

U.S. MARINE CORPS. JROTC
Category 5 – General Military Subjects
Skill 1 – Administration

Figure 1: MCJROTC Chain of Command

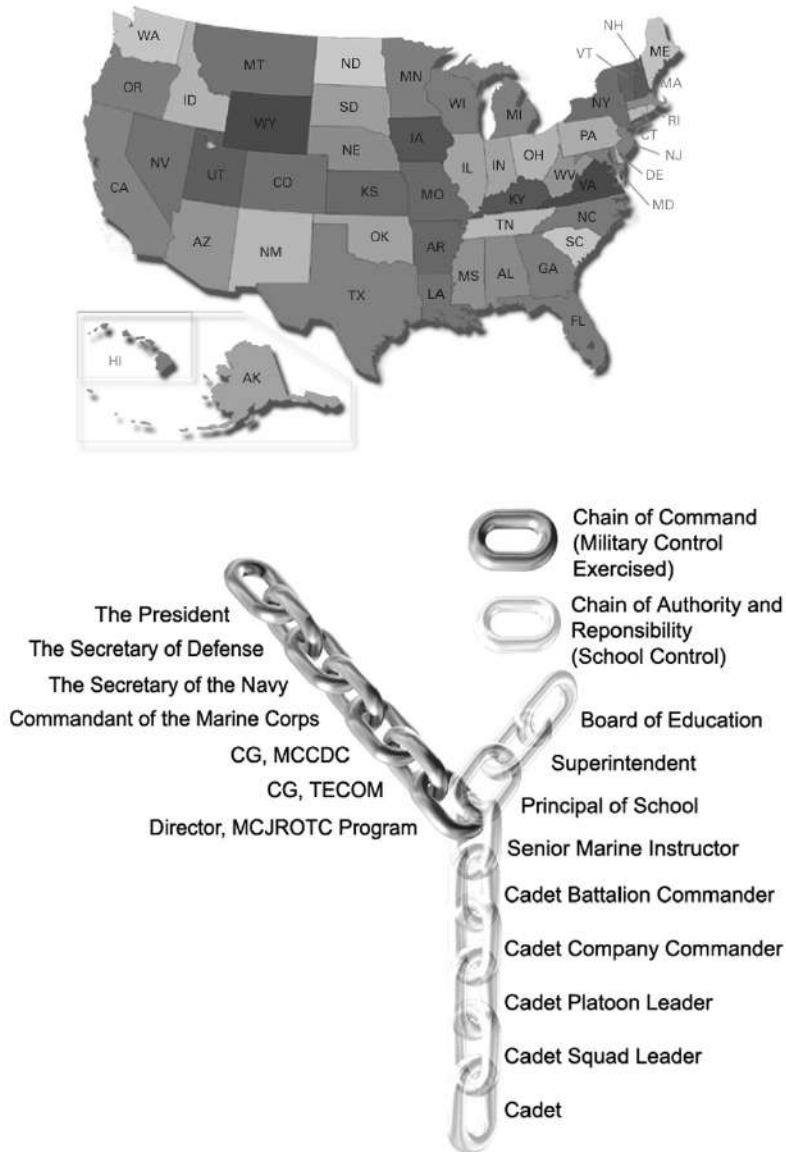

U.S. MARINE CORPS. JROTC
 Category 5 – General Military Subjects
 Skill 1 – Administration

Figure 2: Organizational Structure

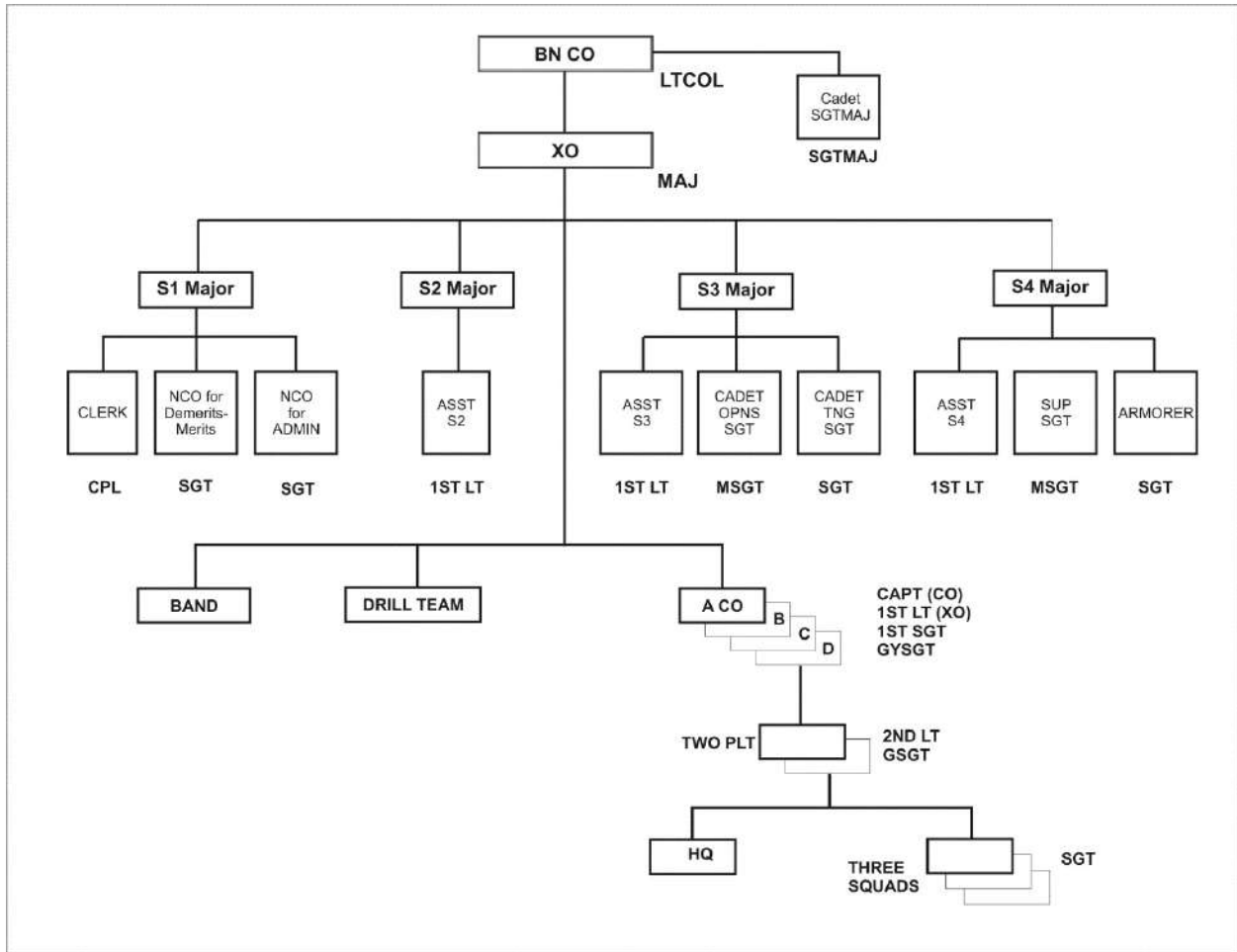

Requirements for MCJROTC Participation

PURPOSE

This lesson identifies the requirements for participation in the MCJROTC program. You will learn about enrollment, citizenship, and physical fitness requirements for participation in the MCJROTC program.



Introduction

Haven't you noticed that there are rules everywhere you go? In everything that you do, certain requirements must be met. To join your community swimming pool, use local recreation facilities, and even go to school, you have to meet the requirements in order to join or attend. The same is true for participation in the MCJROTC program. There are requirements that must be met in order to participate in the MCJROTC.

Background

Congress established the Junior ROTC under the **National Defense Act** of 1916. Certain requirements had to be met as stipulated by Congress under U.S. Code: Title 10, Section 2031. These requirements also determined who could participate in the MCJROTC.

There are three requirements that will determine your MCJROTC participation. They are:

1. High school enrollment
2. **Citizenship**
3. Physical fitness

High School Enrollment

In order to participate in MCJROTC, you must be enrolled in and attending a regular course of instruction in a high school where a MCJROTC unit is located. You cannot be attending one high school while participating in a MCJROTC in another high school. You must also be in a grade above the eighth grade. Therefore, all students in this program are in grades ninth through twelfth. Normally, the majority of the students will be first year students and in the ninth grade, with the remainder ranging from tenth through twelfth grades.

Citizenship

Students enrolled in the MCJROTC program must be in one of the following three citizenship categories:



1. **Citizens** of the United States
2. **Nationals** of the United States
3. **Aliens** lawfully admitted to the United States for permanent residence

A citizen is a person who is born in a country or who chooses to become a member of a country according to its laws. Citizens owe allegiance to their government, which in turn grants them rights and privileges of citizenship. Your rights as citizens are guaranteed under the Fourteenth Amendment, which clearly states that birth and **naturalization** are the two ways to become a citizen of the United States.

Technically, citizenship by birth is possible in one of two ways: *jus soli*, the “law of the soil,” meaning those who are born in the United States, or *jus sanguinis*, the “law of the blood.” For example, although many military family members are born outside the jurisdiction of the United States through the “law of the blood,” they are considered citizens.

Citizenship by naturalization occurs when an individual who was not born in the United States voluntarily chooses to become a citizen of the United States. Those who wish to become naturalized citizens must give up (renounce) their citizenship to their former country and swear an oath of allegiance to the Constitution and laws of the United States.

“National” is applied to a person who is a citizen of a nation, but lives abroad. To be eligible for participation in the MCJROTC program, a student who falls into this category would have to be a national of the United States.

An alien is a foreign-born resident who has not been naturalized and is still a subject or citizen of a foreign country. To meet the requirements for MCJROTC, aliens have to be

lawfully admitted to the United States and applying for permanent residence.

These requirements for citizenship are in keeping with a primary purpose of MCJROTC. Remember, a purpose of JROTC as prescribed by Congress is to instill values of citizenship, service to the United States, personal responsibility, and a sense of accomplishment.

Physical Fitness



Participation in the MCJROTC also requires that students meet health and physical standards. The Semper Fit Fitness Program is the MCJROTC physical fitness program conducted throughout the school year. Cadets must have current school physical evaluations certifying that they are physically fit for participation in the program. The Semper Fit Fitness program

focuses on more than just the physical fitness training aspect; it also provides wellness training to include good nutrition and stress reduction, to name a few. More in-depth coverage will be provided in the lessons on physical fitness.

Conclusion

In conclusion, you are among a select group of young people who meet all of the requirements and have accepted the challenge of being a proud member of the MCJROTC. As a cadet, you will learn what it takes to be a leader while developing as a citizen. You will also improve your physical fitness through participation in physical activities designed to promote healthy competition and establish a pattern of fitness for a lifetime.❖

The Benefits for Successful Completion of MCJROTC

PURPOSE

This lesson identifies the benefits for successful completion of the MCJROTC program. It provides information on promotion potential in the Military, advance placement in Senior ROTC programs, and the potential for early application to Marine Corps Platoon Leaders Class.

Introduction

Did you realize that there are more benefits to MCJROTC than just the things you learn as a cadet participating in the program? Yes, you do learn how to be a leader and team player; and you learn self-discipline. Most important, you learn how to be a better citizen while improving your body and your mind. But, that's not all. There are some great benefits for successful completion of the program as well. The key to being eligible for these benefits is the time you spend as a member of the MCJROTC. The primary benefits for successful completion of MCJROTC are:

1. Promotion potential in the military
2. Advance placement in Senior Reserve Officers' Training Corps (ROTC)
3. Potential for early application to the Marine Corps Platoon Leaders Class

Promotion Potential in the Military

One of the many career options available to you upon graduation is your enlistment in the military. The military is the largest employer of high school graduates in full-time positions. As a member of the MCJROTC, one of the benefits for successful completion is your promotion potential if you decide to join the military. A student presenting evidence of successful completion of at least two academic years of JROTC is entitled to advance promotion to a grade of no less than E-2 on initial enlistment in an active or reserve component of a Military Service. At their discretion, the Military Departments may award the grade of E-3 for successful completion of three or more academic years of JROTC.



Individuals who successfully complete MCJROTC have the potential for advancement in the military, which can offer a lasting impact on their career. The most noticeable impact is in pay grade and the continuing promotion potential. Based on the number of academic years completed, you will already be at least one or two

pay grades ahead of your peers who enlisted at the same time but without any prior JROTC.

Advance Placement in Senior ROTC

The Reserve Officers' Training Corps (ROTC) is a course that you can take while in college. It is normally referred to as the **Senior ROTC program** or **SROTC**. Upon enrollment in a college or university offering the Senior ROTC course, cadets who complete the three- or four-year course of instruction in JROTC may be entitled to one or two years of basic Senior ROTC by the college concerned.



Many colleges and universities across the country offer one or more ROTC programs for the Navy/Marine Corps, Army, and Air Force. In some cases, you may be eligible for a military scholarship (where the military pays most of the educational costs plus a monthly stipend for up to 10 months per year) or financial aid while participating in ROTC. Then, upon graduation from college and successful completion of a Senior ROTC program, you become a commissioned officer. Marines can be newly commissioned to age 28. Participants must be younger than 27 years of age for the Army – 25 for the other services – when commissioned.

Marine Corps Platoon Leaders Class (PLC)

Upon acceptance to a four-year college or university, the cadet who has successfully completed the Junior ROTC course of instruction may apply for the **Marine Corps Platoon Leaders Class** program during the summer prior to their freshman year.

Platoon Leaders Class lets you complete your academic career uninterrupted at the college or university of your choice. If you maintain an overall “C” average or higher and graduate, you’ll be commissioned as a Marine Second Lieutenant.

All PLC training takes place during the summer. For freshmen and sophomores, PLC consists of two six-week training sessions at Quantico, Virginia. For juniors, it’s one 10-week session.

Your instructor can provide guidance and instruction regarding the options available to you.

Conclusion

Upon completion of MCJROTC, you will be provided a certificate of completion. The certificate will serve as evidence that you have successfully completed the program. It is your responsibility to keep your certificate in a safe place so that you will have it, if needed.

Remember, the key to obtaining the benefits discussed in this lesson is your successful completion of the MCJROTC. Currently, you may not see any of these options in your future plans. However, in life, plans can change. In any event, these benefits will be available to you once you have successfully completed MCJROTC. ❖

Promotions and Awards – Signs of Success

PURPOSE

This lesson introduces you to the MCJROTC program promotions and awards systems. It provides an overview of MCJROTC organization, cadet rank structure, promotions, and awards.

Introduction

The MCJROTC has a well-defined organizational structure and has systems to recognize and reward individuals and units for outstanding service or achievement. These two systems are: **Promotions** and **Awards**. As cadets, within the program, you will be afforded the opportunity to be promoted and to receive individual and unit awards.

Organizational Structure

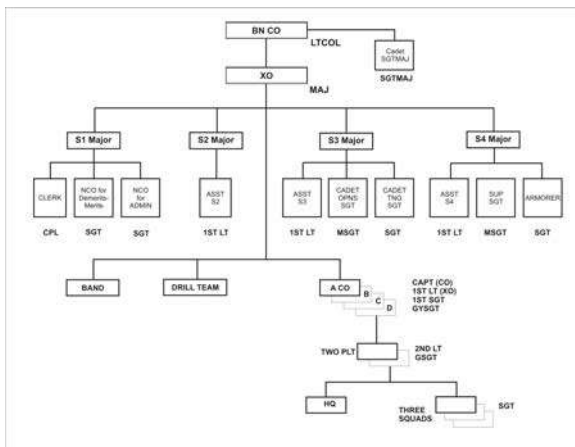

Every MCJROTC unit is organized as either a company or battalion. Within that

company or battalion organization, an organizational chart displays all jobs and positions available. Each job or position has specific descriptions and requirements to include cadet rank.

INSIGNIA OF GRADE FOR CADET OFFICERS

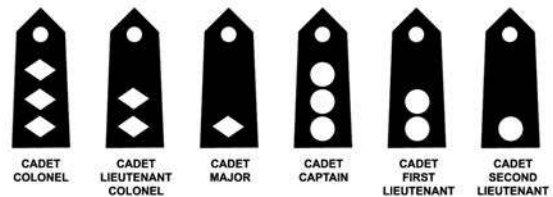

INSIGNIA OF GRADE FOR CADET ENLISTED PERSONNEL

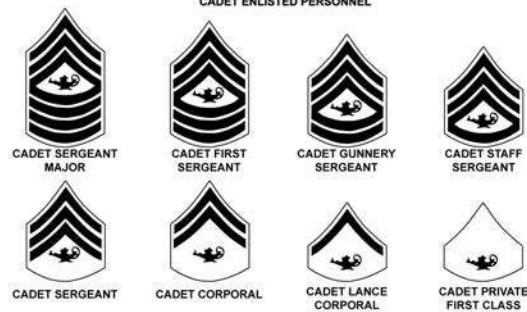

Rank Structure

Rank and grade are terms used by the military to classify Marines as well as other military members. Rank is used within the MCJROTC to classify cadets. Rank is the actual title held by a Marine such as staff sergeant, lance corporal or captain. Grade is a letter/number combination representing the pay level of the rank. An example of the grade using those same ranks would be E6, E3, and O3. Use the word “cadet” with the rank to ensure that there is no confusion between cadets in MCJROTC and the U.S. Marine Corps. Always address individuals by their rank and never by their grade.

Cadets are classified as either officer or enlisted just like in the United States Marines. The insignia for cadets in the MCJROTC program follows the same structure of the insignia for the United States Marine Corps. The cadet officer and enlisted insignia designs are different to prevent confusion. The word cadet should precede the actual rank used. This unique insignia distinguishes uniforms worn by cadets.

Promotions

Promotions are defined by Webster as “the act of furthering the growth or development of something.” Cadets in the MCJROTC are promoted based on ability, skill, experience, and potential.

The Senior Marine Instructor (SMI) will determine promotions and promotion policies. He/she will select the cadet corps commander, subordinate commanders, and staff members required by the organizational structure of the unit. The SMI will also determine policy for promotions within the unit based on its particular organization.

Cadet promotions are normally limited during the first and second years. Remember, in the first year, you are a follower and learning the organization. In the second and subsequent years, you will grow and develop and assume more responsibility and fill leadership roles. By the third and fourth year, you should be senior cadet leaders.

How far you advance in rank is up to you. You will receive the necessary training and have the opportunity to demonstrate excellence in the skills and knowledge you have learned. Your actions and abilities ultimately will let your leaders know if you are ready to move up.















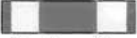

















Awards

Awards publicly recognize meritorious service and outstanding achievement that distinguishes an individual or unit from others. They provide a means of recognizing individual cadets for their performance and participation in the MCJROTC Program. The proper use of awards can improve morale and provide an incentive for greater efforts and achievement.

Ribbons

Ribbons are awards provided to recognize superior performance by units or individual cadets. These awards are designated to recognize participation in MCJROTC activities and certain extracurricular school activities. They must recognize meritorious service or outstanding achievement that exceeds expectations; or must recognize participation in a unit activity or event requiring special dedication and effort. Rewards for academic achievement, extracurricular activities, excellence in competition, contributions to unit goals, and outstanding service are also available. Additionally, some cadets receive national recognition from patriotic and civic organizations for outstanding academic and military achievements.

MCJROTC Ribbons

 Legion of Valor Bronze Cross for Achievement	 MCROA Outstanding Unit Award	 American Legion Bronze Medal for Scholastic Excellence	 American Legion Bronze Medal for Military Excellence	 Sons of the American Revolution JROTC Bronze Medal
 Daughters of the American Revolution JROTC Bronze Medal	 Military Order of the World Wars Bronze Medal	 The Retired Officer Association ROTC Award	 Veterans of Foreign Wars JROTC Bronze Medal	 Daedalian JROTC Achievement Award
 Outstanding Cadet Award	 Women Marine Association Award	 National Sojourners Award	 Noncommissioned Officer Association NCO Leadership Award	 Student Leadership Award
 Officer Leadership Award	 NCO Leadership Award	 Civic Service Award	 Distinguished Conduct Award	 Best Drill Cadet Award
 Distinguished Scholastic Achievement Award	 Arts and Academic Award	 Distinguished Military Training Award	 Physical Achievement Award	 Superior Marksman Award
 Athletic Participation Award	 Longevity and Fidelity Award	 Distinguished Conduct Award	 Best Drill Squad Award	 Color Guard Award
 Drill Team Award	 Band/Drum and Bugle Team Award	 Rifle Team Award		

The following is a list of authorized MCJROTC ribbon awards in order of seniority:

- Legion of Valor Bronze Cross for Achievement
- MCROA Outstanding Unit Award
- American Legion Bronze Medal for Scholastic Excellence
- American Legion Bronze Medal for Military Excellence
- Sons of the American Revolution JROTC Bronze Medal
- Daughters of the American Revolution JROTC Bronze Medal
- Military Order of the World Wars Bronze Medal
- The Retired Officer Association ROTC Award
- Veterans of Foreign Wars JROTC Bronze Medal

U.S. MARINE CORPS. JROTC
Category 5 – General Military Subjects
Skill 1 – Administration

- Daedalian JROTC Achievement Award
- Outstanding Cadet Award
- Women Marine Association Award
- National Sojourners Award
- Noncommissioned Officer Association NCO Leadership Award
- Student Leadership Award
- Officer Leadership Award
- NCO Leadership Award
- Civic Service Award
- Distinguished Conduct Award
- Best Drill Cadet Award
- Distinguished Scholastic Achievement Award
- Arts and Academic Award
- Distinguished Military Training Award
- Physical Achievement Award
- Superior Marksman Award
- Athletic Participation Award
- Longevity and Fidelity Award
- Distinguished Conduct Award
- Best Drill Squad Award
- Color Guard Award
- Drill Team Award
- Band/Drum and Bugle Team Award
- Rifle Team Award

Senior Marine Instructors may desire to institute local personal awards. Such awards may be used effectively to provide incentive for participation and performance in unit activities. Additionally, units may have the opportunity to

participate in competition for awards sponsored by other organizations and institutions.

Local awards that are personal in nature will be junior to the Longevity and Fidelity Award. Local awards recognizing members of a group or unit will be junior to the Rifle Team Award. Seniority of local awards in either of these categories will be in the order in which they were received by the individual or unit.

Unit Awards

In addition to the ribbon awards, the Marine Corps Reserve Officers' Association awards a trophy annually to the most outstanding MCJROTC unit in each Marine Corps District. Cadets who are members of the winning unit during the award period may wear the MCROA Outstanding Unit Award Ribbon.

Units may also be designated as Naval Honor Schools. Those units selected by the District Commanding Officer for attaining the highest overall rating during the school year will be designated Naval Honor Schools by the Commanding General, Marine Corps Combat Development Command (MCCDC). This designation recognizes a unit's exemplary performance during the District Commanding Officer's inspection. Approximately twenty percent of total MCJROTC units in the country are Honor Schools.

Before a cadet may wear any local ribbon or **device** on the MCJROTC uniform, the Commanding General, MCCDC must approve and authorize the award.

Marksmanship Badges

Marksmanship qualification **badges** are awarded annually following qualification firing. Cadets are authorized to wear the qualification badge that reflects the score received during the

most recent annual qualification firing. They retain qualification until the annual qualification firing the next academic year.

Conclusion

The MCJROTC Program Promotion and Awards system rewards deserving cadets. It recognizes you either individually or as a member of a unit for your accomplishments and excellence. To earn promotions and awards, you must be as competitive as your abilities will allow. The results are self-satisfaction and, occasionally, public recognition for your accomplishments.

Remember, promotions will determine how high you will advance within the MCJROTC organization. Awards are a visible sign of your exceptional performance as a cadet. ❖

Codes of Conduct

PURPOSE

This lesson introduces you to codes of conduct. It provides the basic requirements for conduct in school and conduct as a MCJROTC cadet.

Introduction

Did you ever wonder why there are always rules? Have you noticed that there are signs on businesses and organizations everywhere you go that tell you what you can or cannot do? If you go to recreation centers, parks, or your local swimming pool, there are rules. In order to use any of these facilities, you must follow their rules.

Schools and MCJROTC also have rules or behavior standards that must be followed. These rules establish standards of personal behavior (**conduct**) in the school setting and MCJROTC. They are called **codes of conduct**. Codes of conduct are a system of principles or rules that govern conduct. The codes of conduct provide specific expectations or rules for appropriate behavior and the consequences for violating them.

School Codes of Conduct

School codes of conduct vary from school to school depending on their specific needs. Therefore, general guidelines are provided here for school codes of conduct. School codes of conduct usually include the following policies:

- Stated responsibilities of school, students, and parents
- Attendance
- Chemical or substance abuse
- Dangerous objects
- Disruptive behavior
- Fighting/aggression/threats/violent behavior
- **Integrity**
- Transportation
- Tobacco products
- Trespassing
- Vandalism
- Sexual harassment
- Technology and the Internet

Schools typically provide students with the school codes of conduct at the beginning of the school year. Teachers and administrators reemphasize rules throughout the school year as necessary. Students may be required to read, sign, and date the codes of conduct. Parents are usually involved in this process and obliged to ensure that all concerned parties understand the rules and the consequences.

School codes of conduct normally apply to students on school property, on school buses, at school bus stops, and when attending school-sponsored activities. It also applies to student conduct that interferes or obstructs the orderly operation of the school system or the safety or welfare of students, employees, or volunteers of the school system.

MCJROTC Codes of Conduct

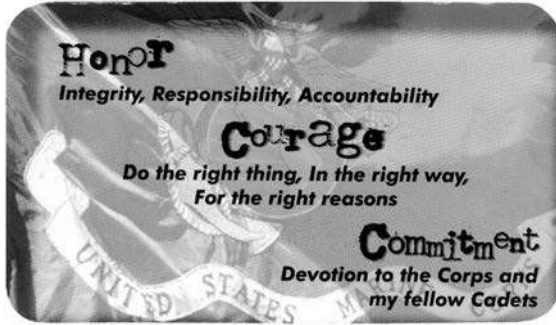

As a MCJROTC cadet, you have certain responsibilities to the Corps. You are expected to maintain high standards for yourself and others. You cannot ask others to do what you will not do. You must set the example by displaying **honor**, **courage**, and **commitment**. However, what are these terms and what do they mean to you?

Honor is the quality that guides ethical and **moral** behavior. It includes integrity, **responsibility**, and **accountability**. To have integrity (honesty) you must have **ethics** and morals. Ethics is a set of standards or a value system by which human actions are determined to be right or wrong, good or evil. Moral behavior is conforming to a standard of right behavior. To be responsible is to be trustworthy or reliable. When you are accountable, you have an obligation or willingness to accept responsibility. This means that you must have integrity and exhibit moral and ethical behavior. It means you must be responsible and accountable for your actions. How can you be a role model, if you do not lead by example? How can someone else depend on you, if you cannot be depended on?

Courage is the mental quality that recognizes fear of danger or criticism but enables a leader to proceed in the face of it with calmness

and firmness. What does this mean to you? It means that you will do the right thing, in the right way and for the right reasons. Does this only involve dangerous situations? No, it means that you will stand up for what is right even when you are the only one to do so. It means that you will not do something just because everyone else is doing it. It means that in your daily life, you will encounter situations that may require courage and you will be expected to exhibit that courage. Does it mean that you will not be fearful? No, it means that you are willing to work through your fear to overcome it and do the right thing or make the right choice for the right reasons.

Commitment is an agreement or pledge to do something. If you are committed, you will stick with it no matter what. Your commitment includes your devotion to the Corps and your fellow cadets.

As an MCJROTC cadet, you represent more than yourself. You represent the Cadet Corps, the school, and the Marine Corps. The following are the MCJROTC Codes of Conduct you should live by:

- Obey the law
- Lead by example
- Respect yourselves and others
- Maintain a high standard of integrity
- Support and defend the Constitution
- Uphold special trust and confidence
- Place faith and honor above all else
- Honor fellow cadets, the Corps, country, and family

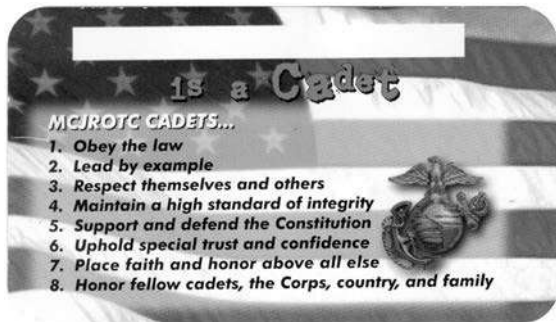

Conclusion

As a cadet in the MCJROTC program, it is important that you obey the school and MCJROTC codes of conduct. You are a role model and are expected to exhibit the highest standards.❖

Professional Personal Appearance

PURPOSE

This lesson provides information on maintaining and presenting a professional personal appearance. Upon completion of this lesson, you will understand the importance of a good professional personal appearance, describe the personal traits that make up a professional personal appearance, and describe the specific Marine Corps requirements for maintaining and presenting a professional personal appearance.

personal appearance. In MCJROTC, being neat and clean is a way of life.

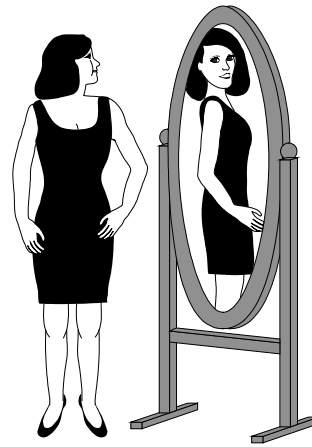

Good Posture
Proper Weight
Good Muscle Tone
Good Grooming

Introduction

We often form opinions of others based on their personal appearance. As a cadet, other people will often identify and judge you on your personal appearance. A good personal appearance complements the wearing of your uniform. A neatly pressed and clean uniform and properly groomed person show that MCJROTC cadets have pride in themselves as well as in their unit, and they use self-discipline to get things done. This lesson introduces cadets to the importance of maintaining and presenting a professional personal appearance.

Your Personal Appearance

How do you look today? Do you have good posture? Do you have good grooming (personal hygiene) habits? In addition to these two areas, proper weight control and good muscle tone are all equally important factors in your

Good personal grooming is an important part of projecting a positive image. Your personal appearance can make all the difference in how you look in uniform. The following guidelines will give you that polished look.

- **Good posture** involves more than just standing tall. It is sitting, walking, bending, and lifting properly. Poor posture can cause backaches, digestive trouble, and fatigue. You will become more relaxed and at the same time more energetic when you have good posture. It takes some practice to correct any bad habits, but in time the rewards are well worth the effort.
- **Proper weight** is a major health concern in our society. There is great pressure to be thin. But, being too thin (or overweight) can affect your self-image as well as your health. A balanced diet is the key to proper weight. Some people go to extremes by overeating or

crash dieting; both are equally dangerous. See your family doctor for advice on weight reduction and dieting.

- **Good muscle tone** comes from a well-rounded exercise program. Swimming, bicycling, walking, and tennis are types of regular exercise that tone and build muscles. Exercise helps you feel good, both physically and mentally.
- **Good grooming** means proper personal hygiene – taking care of your body. Daily showers or baths are vital, as is brushing your teeth. Proper amounts of sleep are also important to your mind and body.

Maintaining a Professional Personal Appearance

Maintaining a good personal appearance is the foundation for presenting a professional appearance. The main objective of a professional appearance is to be visibly identified with a particular group or an associated attribute. While you may look great in slacks and sneakers, it would not look appropriate in a formal business setting. A professional appearance projects your affiliation and attitude. That is to say, how you look shows others your pride in yourself and those you represent.

Maintaining a professional appearance is an important leadership trait. It is every cadet's responsibility to "lead from the front." Set the example for others to follow in areas of military bearing and self-improvement among others.

Since many of your peers will now recognize you as an MCJROTC cadet, they will be watching you, and your appearance, more closely than before. Therefore, your appearance both in and out of uniform must be immaculate. The following story exemplifies the importance of

keeping a neat and clean personal appearance, even while out of uniform.

Rick was applying for a new job. On the day of the interview, he woke up late and did not have time to take a shower or iron a shirt that he was wearing with his suit and tie. As Rick ran a brush through his hair, he told himself, "Confidence and credentials are what will get me this great job ... and I have those."

When Rick arrived at the office, he told the secretary, "I have an appointment with Mr. Bender at one o'clock." As Rick was leaving the receptionist's area for the interview, dirt fell from one of his shoes. He meant to clean and polish them before the interview, but he did not have time. He apologized and told the secretary that he would clean up the dirt after the interview. She told him not to worry about it.

During the interview, Mr. Bender asked Rick several tough questions, which Rick felt he answered very well. Then, at the close of the interview, Rick expected to be offered the job. Instead, Mr. Bender thanked him for coming and told him that he would be in touch.

After a few days, Rick received a letter from Mr. Bender. It stated in part, "I appreciated your enthusiasm, and your qualifications were excellent, but the company has hired someone else for the position."

Did Rick present himself to Mr. Bender in the best possible way? Even though Rick thought that he was mentally alert, confident, and ready for the interview, was he really prepared for it? Although Rick thought that his qualifications would get him the job, should he have taken more time and care with his personal appearance?

As shown in the previous example, how you dress, in addition to your personal grooming, affects how people view you.

According to Marine Corps regulations on the wear and appearance of uniforms, “all personnel will maintain a high standard of dress and appearance.” This regulation means that your personal appearance in uniform should project the image to others that you are a part of one of the finest groups in the world.

Learning how to look your best in uniform takes time and effort. Your uniform must be sized and fitted to give you comfort and a good appearance. There is nothing worse than trousers/slacks, shirts, or coats that do not fit. Your trousers/slacks should be hemmed to the required length and your shirt and coat, issued by size, should also fit well.

Factors That Affect Appearance

Once you have a perfect fitting uniform, there are still other guidelines to follow so that you can maintain an outstanding appearance:

- Have good personal grooming habits, such as caring for your hair and fingernails.
- Know how to wear the uniform properly.
- Know how to care and clean the uniform – a proper appearance requires a pressed and cleaned uniform.

These factors and the following information are the basic keys to a good overall appearance in your MCJROTC uniform.

Guidelines for Personal Appearance in the MCJROTC Uniform

By following these guidelines, you can ensure that your uniform and your personal appearance are in accordance with regulations.

- Male cadets: Keep your hair neatly trimmed with sideburns no lower than the bottom of the ear opening and be clean-shaven.

- Female cadets: Keep your hair styled so that it does not fall below the bottom edge of the collar and so that the cap can be worn easily.
- Keep fingernails short and clean. Female cadet’s fingernails may be no longer than ¼ inch from the tip of the finger to tip of the nail.
- A good personal appearance includes good grooming, which you can only achieve by cleaning your hair, teeth, and the rest of your body. It also includes maintenance (care) of your clothing – making sure that it is cleaned and pressed. In MCJROTC, you must maintain your uniform.

Guidelines for Wearing Your MCJROTC Uniform

- Wear a clean and neatly pressed uniform.
- Tuck shirt into trousers; maintain its military alignment (sometimes referred to as **gigline**), that is, keep its seam aligned with the seam of the zipper flap of the trousers and the edge of the belt buckle.
- Button all buttons, with the exception of the top or collar button of the shirt or blouse.
- Clean, polish, and properly display all brass on the uniform.
- Push the belt through the left front loop of the trousers first and adjust to allow only the tip of the belt to protrude from the buckle.
- Wear only issued socks and shoes with the uniform.
- The wearing of a wristwatch, a wrist identification bracelet, and not more than two rings is authorized with MCJROTC uniforms (unless prohibited for safety or health reasons) as long as the style is conservative and in good taste.

- Female cadets may also wear small yellow gold colored ball or round stud earrings (not to exceed six millimeters (about 1/4 inch) in diameter).
- Male cadets may not wear earrings while in uniform, or on any MCJROTC functions
- Do not carry bulky objects in any pocket of the uniform.
- Wear the cover at all times when out of doors.

MCJROTC Personal Appearance Standards in Uniform

The Marine Corps uniform regulations for standards of personal appearance and grooming are as specific as practicable in order to establish the parameters with which Marines must comply. MCJROTC uniform standards of grooming do not allow **eccentric** or faddish styles of hair, jewelry, or eyeglasses. Eccentricities in individual appearance detract from uniformity and team identity. Because it is impossible to provide examples of every appropriate or unacceptable style of “conservative” or “eccentric” grooming and attire, the good judgment of Marines at all levels is key to enforcement of MCJROTC standards in this issue, as in other issues.

Articles that are not authorized for wear as a part of a regulation uniform will not be worn exposed with the uniform unless otherwise authorized by the Commandant or higher authority. Examples of such articles include but are not limited to the following: Pencils, pens, watch chains, fobs, pins, jewelry (except as authorized herein), handkerchiefs, combs, barrettes, hair ribbons or ornaments, flowers (corsages/boutonnieres, etc.) or other similar items such as cellular phones, pagers, etc. are not authorized for wear on a regulation uniform.

Articles that may be worn while in uniform include inconspicuous wristwatches and rings. Sunglasses may be worn on leave, liberty, and in garrison but not in formation with troops, unless the need to wear sunglasses has been certified by medical authorities. When authorized for wear in formations, sunglass lenses will be of standard green or dark green shade or may be the type commonly referred to as “photosensitive.” Eyeglasses/sunglasses, when worn, will be conservative in appearance. Eccentric or conspicuous eyepieces are prohibited. Chains, bands, or ribbons will not be attached to eyeglasses; however, eyeglass restraints are authorized for safety purposes.

Subject to temporary revocation due to health, safety, or mission requirements, MCJROTC may wear neat and conservative:

- Articles of religious apparel that are not visible or apparent when worn with the uniform.
- Visible articles of religious apparel with the uniform while attending or conducting divine services or while in a chapel or other house of worship.
- Visible articles of religious apparel with the uniform, which do not interfere with or replace required uniform articles.

Grooming Regulations:

1. No eccentricities in the manner of wearing head, facial, or body hair will be permitted. If applied, dyes, tints, bleaches, and frostings, which result in natural colors, are authorized. The hair color must complement the person's complexion tone. Color changes that detract from a professional image are prohibited. Fingernails will be kept clean and neatly trimmed so as not to interfere with performance of duty, detract from MCJROTC image, or present a safety hazard.

2. Male cadets will be well groomed at all times and will abide by the following:

- Hair will be neat and closely trimmed. The hair may be clipped at the edges of the side and back; will be evenly graduated from zero length at the hairline in the lower portion of the head to the upper portion of the head; and will not be over 3 inches in length fully extended on the upper portion of the head; the back and sides of the head below the hairline may be shaved to remove body hair. Sideburns will not extend below the top of the orifice of the ear. Sideburns will not be styled to taper or flare. The length of an individual hair of the sideburn will not exceed 1/8 inch when fully extended.
- Head hair will be styled so as not to interfere with the proper wear of uniform headgear. Hair that protrudes from beneath properly worn headgear in an unsightly manner is considered excessive, regardless of length.
- The face will be clean-shaven, except that a mustache may be worn. When worn, the mustache will be neatly trimmed and must not extend below the line of the upper lip nor beyond the corner of the mouth. The individual length of a mustache hair fully extended must not exceed 1/2 inch.
- Except for a mustache, eyebrows, and eyelashes; hair may be grown on the face only when a medical officer has determined that shaving is temporarily harmful to the individual's health. In these cases, the current edition of MCO 6310.1 applies.

3. The requirement for hair regulations is to maintain uniformity within a military population. Female cadet hairstyles require

non-eccentric styles. Female Marines will be well groomed at all times and when in uniform will abide by the following:

- Hair may touch the collar, but will not fall below the collar's lower edge. Hair that would fall naturally below the collar's lower edge will be neatly and inconspicuously fastened or pinned. During physical training periods in which physical training clothing is worn, hair will be allowed to fall naturally, without being fastened or pinned. This does not apply when conducting physical training in the utility uniform
- Hair will be styled so as not to interfere with the proper wear of the uniform headgear. All headgear will fit snugly and comfortably around the largest part of the head without distortion or excessive gaps. Hairstyles that do not allow the headgear to be worn in this manner are prohibited
- Faddish and exaggerated styles to include shaved portions of the scalp other than the neckline, designs in the hair, unsecured ponytails and styles that are distinctly unbalanced or lopsided are prohibited. Multiple braiding is authorized. If hair extensions are used in the braiding of the hair, the extensions must have the same general appearance as the individual's natural hair. Braided hairstyles will be conservative, and conform to other guidelines listed herein.
- Barrettes, combs, rubber bands, etc. are authorized, if concealed by the hair. Inconspicuous hairpins and bobby pins, if required, are authorized. Hairnets will not be worn unless authorized for a specific type of duty. Wigs, if worn in uniform, must look natural and conform to the above regulations.

- Cosmetics, if worn, will be applied conservatively and will complement the individual's complexion tone. Exaggerated or faddish cosmetic styles are inappropriate with the uniform and will not be worn. Non-eccentric lipstick and nail polish colors, to include colorless nail polish, may be worn with all uniforms. Fingernails with multiple colors and decorative ornamentation are prohibited. Nail length will be no longer than 1/4 inch from the tip of the finger.

Conclusion

Your personal appearance affects what others think about you. How you look can also influence your own self-confidence. Take some time to study yourself. Are you neat and presentable in and out of uniform? It is not hard to look your best. A clean uniform, good personal appearance (posture, weight, and muscle tone), and good grooming are keys to success. The Marine Corps regulations governing personal appearance were developed to ensure that Corps personnel present a standard and acceptable image to others. That image speaks of the pride in self and unit maintained by all Marine Corps JROTC cadets.❖

Introduction to MCJROTC Uniforms

PURPOSE

This lesson provides an overview of the various Marine Corps uniforms from the colonial times through today's MCJROTC uniform. Also presented is an overview of insignia, devices and awards worn on the MCJROTC uniform.

Introduction

The word uniform comes from two Latin words, *unus* and *forma*, which mean “one form”. From the earliest times, soldiers in battle have needed a way to distinguish friend from foe. When the battles involved people from different cultures; for example, Romans and Gauls or Crusaders and Moslems, it was fairly easy to tell who was on the opposing side. However, identification became a problem for early European armies. Many of the soldiers were mercenaries who would fight in any army that could pay them. Usually, each soldier was responsible for providing his own clothing and equipment. The result was that on the battlefield many armies looked very much alike.

The development of uniforms eliminated the problem of distinguishing armies. It also served to identify ranks and arms of service in each army. In modern times, the origins of uniforms stem from the late 1660s. The King of France, Louis XIV, introduced uniforms to distinguish the various regiments of the French army. These early uniforms were very colorful, more suited for parade field than the battlefield.

Images of the British “Redcoats” and Napoleon’s “Grande Armee” come to mind.

By the end of the nineteenth century, however, the realities of war drove home the need for functional uniforms that could help conceal the wearer. World War I saw the bright reds and blues disappear to be replaced by green, grays, and khakis. Today, this trend continues with camouflage uniforms, some of which are specially designed to reduce unwanted reflection (an example of this is **subdued** rank and insignia).

The Marines have worn a variety of uniforms throughout their long and glorious history. The uniforms of the United States Marine Corps are unique, displaying the pride and history of the Corps itself.

History of the Marine Corps Uniform

The uniforms worn by the United States Marine Corps have changed with the passage of time. When the Continental Marines were organized in 1775, their uniform consisted of green coats with white facings, white waistcoats, white breeches, short black **spats** (called “spatterdashes”), and round felt hats. Every Marine, officer and enlisted, wore a leather neckpiece from which we get the name “leatherneck.” The neckpiece was designed to keep the head erect to maintain a constant military appearance. It is also said that this leather neckpiece protected the throat from saber slashes. In 1798, the Corps was reformed and the Marines wore surplus Army clothing. This consisted of a blue coat, scarlet vest, and tight blue trousers with thin scarlet stripes.

In 1804, the first Uniform Regulations were issued, again providing for white trousers. The felt hat was also changed to a **shako** with pompon that was worn during the War of 1812. Another traditional part of the uniform that dates from this period is the Mameluke sword. It gets its name from the style of its cross-hilt and ivory grip, derived from Moslem swords. Marine officers began to carry swords of this pattern following the campaign against the Barbary pirates in North Africa (1801-1805).

It was not until 1822 that NCO **chevrons** were introduced. Captains and lieutenants also wore **chevrons** until 1830. Four years later, the handsome blue, white, and scarlet uniforms were shelved for green **coatees** with buff facings and for gray trousers with buff stripes for officers and NCOs. This color combination, however, was not popular and lasted only a few years.

In 1839, the traditional Marine Corps colors of blue, white, and scarlet were restored. The 1839 uniform was a blue coat with red piping, standing collar and leather neckpiece, and white crossbelt. In summer, troops wore white trousers. In winter, these were changed to sky-blue trousers (with scarlet stripes for officers and NCOs). In 1839, the Marine Corps Band wore red coats, as did all field musicians, which are still worn today. Except for changes in cut, headgear, and accessories, the 1839 uniforms are the blues of today.

At the time of the Civil War, the service uniform was virtually a copy of the Army uniform. The dress uniform, however, was an eye-catcher. Even privates wore gold **epaulettes**, white crossbelts, and high-crowned hats with scarlet pompons. This uniform lasted until 1875 when the headgear was replaced with a blue or white spiked helmet. An all white tropical uniform with standing collar and the first field uniform (composed of coarse gray “cheesecloth” material

and Army pattern blue flannel shirts) was also issued. At this time, a part of Marine Corps tradition ended when the leather neckpiece was abolished after exactly 100 years as part of the uniform.

The war with Spain in 1898 brought the need for new types of uniforms. The blue blouses and spiked helmets were unsuitable for field service in Cuba and the Philippines. A new khaki linen uniform with a brown felt campaign hat was issued. This uniform with a standing collar became the standard field uniform of the Marine Corps. In 1912, a forest green uniform was adopted for winter field service. With a few minor differences, the dress uniforms of this period are still in use today.

During World War I, the Marines in France wore Army olive drab uniforms with wrapped cloth spiral **puttees**. After the war, the Marines went back to standard combinations of blues, khakis, and greens. The khaki uniform was the standard field uniform when the Corps campaigned in Haiti, Nicaragua, and Santo Domingo. In fact, khaki was the first field uniform for most of the Marine Corps units that fought in the Pacific in the early months of World War II. By the end of 1942, the green utility



uniform and field shoes had been adopted, replacing both the khaki uniform and felt field hat.

With the arrival of utilities, the basic field outfit of the Marine Corps uniforms had reached virtually what it is today. Camouflage clothing was first issued in Vietnam as a special item. In the late 1970s, however, it was adopted as the standard utility uniform and remains so today

Marine Corps Uniforms of Today

Presently, Marine Corps uniforms are divided into three categories: dress, service, and utility. Each type, for both male and female personnel, is described in the following sections.

Dress Uniforms

For parades, ceremonies, reviews, and official social occasions, Marines wear what are termed dress uniforms. Marine Corps personnel wear two forms of dress uniforms. These are the Blue-White Dress and Blue Dress uniforms. Some forms of dress uniforms may also be worn on leave or liberty. There are two combinations of dress uniforms that are of interest to MCJROTC personnel. These are designated dress B and C. There are significant differences between the dress uniforms for male and female personnel.

Blue-White Dress A Uniform: The blue-white dress A uniform consists of the same items as the blue dress A except the trousers/skirt/slacks will be white. This uniform may only be prescribed for official parades, ceremonies, reviews, and formal/ semiformal social occasions and will not be worn on leave or liberty.



The blue-white dress B uniform consists of the same items as the blue-white dress A uniform, except that ribbons are worn in lieu of medals (shooting badges may be prescribed). This uniform will be worn under the same conditions as the blue dress B uniform. This uniform can be worn on leave and liberty.

Blue Dress A Uniform: Marines wear this uniform when reporting for sea duty, parades, ceremonies, reviews, and other occasions as determined by the commander. It may also be worn for leave or liberty. It should be noted that the blue dress B uniform is identical to the blue dress A uniform except that ribbons are worn in place of medals.



Blue dress C Uniform: This uniform consists of the blue dress uniform with the long sleeve khaki shirt. The khaki shirt, insignia of grade, and (for male personnel) service necktie with necktie clasp may be prescribed instead of the blue coat. For female personnel the khaki shirt and black neck tab may be prescribed instead of the blue coat. The blue dress C uniform may be worn as the uniform of the day. However, it will not be worn at ceremonies, parades, liberty, leave, or other functions where the wearing of the blue coat would be more appropriate.

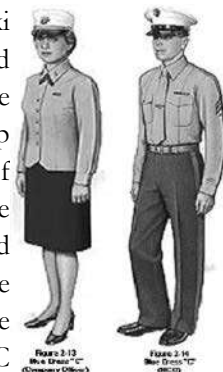

Blue dress D Uniform: The blue dress uniform with short sleeve khaki shirt (without coat) is designated as blue dress D. Commanders may prescribe blue dress D as the uniform of the day for specified



occasions or duties. During the winter uniform period, commanders may, at their discretion when the weather requires, authorize blue dress D as the uniform of the day. Commanders may prescribe this uniform for honors, parades, and ceremonies where climatic conditions preclude the comfortable wear of the blue dress A or B uniforms. This uniform is authorized for leave or liberty.

Service Uniforms

For most day-to-day activities, Marine personnel wear what are termed service uniforms. There are three forms of service uniforms, designated A, B, and C. Although both male and female personnel use the same designations for service uniforms, there are naturally differences between them. There are also set service uniform guidelines.

Service A Uniform: Marines wear this uniform combination when they report for duty on shore or are assigned duty as members of a court-martial. Women may wear either the long or short sleeve khaki shirt and green neck tab with this uniform. The service A uniform includes the appropriate service coat. However, when it is prescribed as the uniform of the day, it is considered appropriate to remove the coat when inside office buildings of a military establishment.



Service B Uniform: (with long sleeve shirt and tie) is the same as the service A uniform except that the service coat is not worn. For women this uniform consists of the long sleeve khaki shirt and green neck tab with appropriate green skirt. This



uniform may be worn as the uniform of the day and for leave and liberty, unless otherwise prescribed by the commander, and may be prescribed for formations at parades or ceremonies on and off the military activity. This uniform will not be worn for formal or semi-formal social events.

Service C Uniform:

This uniform consists of the quarter-length sleeve shirt with appropriate service trousers. Women may wear the green skirt. No neck tab is worn with this uniform. During the winter season, commanders may, at their discretion, authorize the wearing of the service C uniform if the weather is appropriate. This uniform may be worn as the uniform of the day, for leave and liberty (unless the commander prescribes otherwise), and in formation at ceremonies both on and off the military activity. It shall not be worn for formal or semiformal social events.

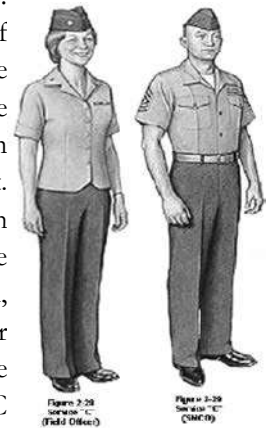

Wearing of Slacks: Commanders may authorize female personnel to wear slacks with the service A, B, or C uniforms under the following conditions:

1. For performance of duties that require the individual to run, climb, or perform activities wherein the wearing of the skirt would be impractical or immodest.
2. When riding in a government airplane configured for cargo or driving government vehicles, such as trucks.
3. When specifically prescribed for ceremonial formations, inspections, parades, or other ceremonies.

4. Slacks may also be authorized for all women Marines under extreme weather conditions.

Utility Uniforms

The camouflage utility uniform is not authorized for wear except when in the field for field-type exercises or for those work conditions wherein it is not practical to wear the service uniform. An exception to this is in the Fleet Marine Forces wherein the wear of the utility uniform by designated units is an enhancement of readiness. (Note that a green T-shirt is to be worn with the utility uniform.)



Physical Training Uniform

The required physical training (PT) uniform consists of the green general purpose trunks and the standard brown or green undershirt. The wear of footwear or headgear with this uniform will be as prescribed by the commander. No unit distinguishing marks or other ornamentation will be placed on the uniform. This uniform will be prescribed for all command PT activities except on those specific occasions when the commander determines that the wear of another uniform or other clothing is more appropriate.

Undergarments

Male personnel are required by regulations to wear standard underwear, either boxer or jockey style, white in color. There are no regulations regarding the style or color of undergarments for female personnel.

Being “Out of Uniform”

The wearing of the uniform should be a matter of personal pride to all Marine Corps

personnel. Officers and enlisted Marines are required to maintain their uniforms and equipment in a neat and serviceable condition. By their appearance, they set an example of orderliness and conformity to uniform regulations. For these reasons, it is important that all Marines avoid being out of uniform. Primarily, this refers to unauthorized mixing of uniform combinations. For example, male personnel are not permitted to wear the blue trousers of the blue dress B uniform with a short sleeve khaki shirt from the service C uniform. Refer to Table 1 at the end of this chapter for an explanation of uniform combinations.

In addition, elements of civilian clothing are not to be mixed with parts of the uniform. On the uniform itself, care must be taken to ensure that all insignia, indications of grade, and medals/ribbons are correctly positioned and aligned. Lastly, uniform components such as footwear, panty hose, laces, and other elements must conform to regulation standards. Attention to the care and proper wearing of the uniform reflects the pride of individuals in the Marine Corps and themselves.

According to Marine Corps Regulations on the wear and appearance of uniforms, “all personnel will maintain a high standard of dress and appearance.” This regulation means that your personal appearance in uniform should project the image to others that you are a part of one of the finest groups in the world.

Learning how to look your best in uniform takes time and effort. Your uniform must be sized and fitted to give you comfort and a good appearance. There is nothing worse than pants, shirts, or coats that do not fit. Your pants should be hemmed to the required length and your shirt and coat, issued by size, should also fit well.

The MCJROTC Uniform

Members of the MCJROTC will wear the uniform and insignia in accordance with MCO P1020.34F, and as amplified by MCO P1533.6.

The district headquarters will provide specific instructions relating to the procedures of requisitioning, control, issuing, maintenance, recovery, and replacement of MCJROTC uniforms.

A JROTC Memorandum Receipt for Uniform Issue (4430) will be filled out for each cadet of the unit.

The SMI will determine which uniform items will be issued and the uniform of the day worn by the cadets so long as that issue does not exceed allowances listed in Appendix N (male) and Appendix O (female) of MCO P 1533.6. This local SMI discretion will comply with established Marine Corps uniform regulations. At no time is the wearing of civilian attire with the MCJROTC uniform authorized (i.e., red windbreakers, baseball cap styled covers, etc.). The MCJROTC uniform will be worn at least once weekly by all cadets of the unit.

Marine Corps Junior ROTC Cadet Officer Insignia

The description for cadet company and field grade officer insignia is set forth below:

- a. The cadet company grade officer insignia consists of a flat disk, $\frac{3}{4}$ of an inch in diameter (large size) and $\frac{1}{2}$ an inch wide in diameter (small size).
- b. The Cadet field grade officer insignia consists of flat lozenges, $\frac{3}{4}$ of an inch wide by $1\frac{1}{4}$ inches long (large size) and $\frac{1}{2}$ an inch wide by $\frac{3}{4}$ of an inch long (small size).
- c. All cadet officer insignia will be of silver metal.

Placement of MCJROTC officer disks and lozenges on the uniform will be in the manner prescribed for the Marine Corps general officer insignia. The lozenge will be worn as follows:

- Coat -- the long axis will point fore and aft.
- Shirt (including shirt w/quarter length sleeves) -- one long axis point of each lozenge will point toward the top edge of the collar.
- Garrison cover -- right front and centered.

Only the grade insignia set forth in Appendix R of MCO P1533.6 is authorized for cadet officers and will be furnished at Government expense.

Marine Corps Junior ROTC Cadet Enlisted Insignia

The cadet enlisted gold on scarlet MCJROTC insignia will not be sewn on the blue coat, instead, the gold metal cadet rank insignia will be placed on the coat epaulette, and the plastic grade insignia will be worn on the collar of the utility coat and khaki shirts as set forth in MCO P1020.34. Scarlet on green MCJROTC insignia will be worn on the green coat. No other style of enlisted grade insignia will be authorized for wear on the MCJROTC uniform.

The MCJROTC enlisted grade insignia contains a Lamp of Learning device in lieu of crossed rifles used in the Marine Corps. The Lamp of Learning signifies intensive study, a source of intellect, and moral and spiritual illumination. The Lamp of Learning is the heraldic device associated with Junior ROTC.

Distinguishing Devices

School patches and the MCJROTC distinctive patch are the only distinguishing devices authorized for wear on the MCJROTC uniform.

A distinctive MCJROTC round patch will be worn on the left sleeve of all outer clothing except the service sweater and AWC. It will be centered on the outer half of the sleeve, ½ inch below the shoulder seam as set forth in MCO P1020.34F for all uniform clothing. The patch will be three inches in diameter and contain a gold Marine Corps emblem centered on a scarlet field that is surrounded with a blue border containing the words “US Marine Corps Junior ROTC” in white lettering. A gold border surrounds the blue field. Distinctive MCJROTC patches, including the cost of sewing on and removal of the patches from uniform clothing, will be furnished at Marine Corps expense.

In addition to the required distinctive patch, one school patch may be worn on the right sleeve of all outer clothing, except the service sweater and AWC, centered on the outer half of the sleeve, ½ inch below the shoulder seam. Patches will be from two inches to 2-1/2 inches in length or diameter.

A 9/16 of an inch wide red stripe for blue uniform trousers will be worn by all MCJROTC cadets.

Awards

Awards are for the purpose of publicly recognizing meritorious service and outstanding achievement that distinguishes an individual or unit from others.

They provide a means of recognizing individual cadets for their performance and participation in the MCJROTC Program. The proper use of awards can improve morale and provide an incentive for greater efforts and achievement. However, the indiscriminate employment and proliferation of awards can destroy their intended purpose.

Only those awards, decorations, and badges prescribed in MCO P1533.6 will be worn

by cadets on the MCJROTC uniform, per MCO P1020.34. Other service JROTC medals and ribbons can be worn as set forth in MCO P1020.34.

MCJROTC Ribbon Awards

The CG, MCCDC (C 462R) authorizes ribbon awards to recognize superior performance by units or individual cadets. These awards are designated to recognize participation in MCJROTC activities and certain extracurricular school activities that require special dedication and effort beyond the normal MCJROTC course requirements.

Seniority of Ribbon Awards

The MCJROTC ribbon awards are listed in order of seniority:

- Legion of Valor Bronze Cross for Achievement
- MCROA Outstanding Unit Award
- American Legion Bronze Medal for Scholastic Excellence
- American Legion Bronze Medal for Military Excellence
- Sons of American Revolution JROTC Bronze Medal
- Daughters of the American Revolution JROTC Bronze Medal
- Military Order of the World Wars Bronze Medal
- The Retired Officer Association ROTC Award
- Veterans of Foreign Wars JROTC Bronze Medal
- Daedalian JROTC Achievement Award
- Outstanding Cadet Award
- Women Marine Association Award

- National Sojourners Award
- Noncommissioned Officer Association Award
- Student Leadership Award
- Officer Leadership Award
- Noncommissioned Officer Leadership Award
- Civic Service Award
- Best Drill Cadet Award
- Distinguished Scholastic Achievement Award
- Arts and Academic Award
- Distinguished Military Training Award
- Physical Achievement Award
- Superior Marksman Award
- Athletic Participation Award
- Longevity and Fidelity Award
- Distinguished Conduct Award
- Best Drill Squad Award
- Color Guard Award
- Drill Team Award
- Band/Drum and Bugle Team Award
- Rifle Team Award

Local awards, which are personal in nature, will be junior to the Longevity and Fidelity Award. Local awards recognizing members of a group or unit will be junior to the Rifle Team Award. Seniority of local awards in either of these categories will be in the order in which they were received by the individual or unit.

Shooting Badges

Marksmanship qualification badges will be awarded annually following qualification firing. Cadets are authorized to wear the qualification badge that reflects the score received during the

most recent annual qualification firing. They will retain qualification until the annual qualification firing the next academic year.

Care of Uniforms and Accessories

The distinctive uniforms cadets wear reflect the justifiable pride felt by members of the Marine Corps JROTC. Keeping these uniforms looking sharp on the parade field and in everyday activities, means spending time in their upkeep. The uniform cannot simply be worn, put away, and forgotten until the next time it is needed. Like any other item of clothing you want to preserve, the uniform requires special care in wearing, storing, and cleaning. The following procedures are outlined to help you maintain your cadet uniform in the proper way. Following these guidelines will ensure that your cadet uniform will always look clean and neat. It will also prolong its life.

General Guidelines for Uniform Wear

No matter how well-fitting a uniform is when new, it will not continue to look its best unless it is well-cared for both during wear and when not in use. A uniform should be carefully put on and kept buttoned. When not in use, uniforms should be carefully placed on hangers. They should be kept in a well-ventilated storage space. Well-constructed wooden hangers shaped to fit the shoulder contour with locking trouser bars are recommended. When uniforms are folded in duffel bags or other containers for storage or shipment, they should be carefully folded. This will preserve their original shape.

Conclusion

The Marine Corps uniform has a proud and distinctive history of identifying its wearer as a

member of the finest military organization in the world. The proper wearing of the uniform should be a matter of personal pride to all cadets. Knowing that one's uniform is clean, neat, and conforming to regulations gives confidence and improves self-esteem. Achieving this, however,

does require careful cleaning and storing. By following the provided guidelines, you will be rewarded by a uniform that projects the pride you experience as a member of the MCJROTC.❖

U.S. MARINE CORPS. MCJROTC
Category 5 – General Military Subjects
Skill 3 – Uniforms, Clothing, and Equipment

UNIFORM COMBINATION	DESCRIPTION	OCCASIONS FOR WEAR
Blue Dress A	Blue coat and trousers/skirt/slacks w/medals	Parades, ceremonies, formal or semiformal social functions
Blue Dress B	Same as A but w/ribbons in lieu of medals	Parades, ceremonies, formal or semiformal social functions
Blue-White Dress A or B	Blue coat w/white trousers/skirt/slacks and medals (A or B)	Parades and ceremonies (summer only)
Blue Dress C	Long-sleeve shirt and tie w/blue trousers/skirt/slacks	Parades, ceremonies, and uniform of the day
Blue Dress D	Short-sleeve shirt w/blue trousers/skirt/slacks	Parades, ceremonies, and uniform of the day
Service A	Green coat and trousers/skirt/slacks w/ribbons	Parades, ceremonies, social events and uniform of the day
Service B	Long-sleeve shirt w/green trousers/skirt/slacks	Parades, ceremonies, and uniform of the day
Service C	Short-sleeve shirt w/green trousers/skirt/slacks	Parades, ceremonies, and uniform of the day
Utility Uniform	Camouflage coat and trousers (sweater may be worn underneath)	Working uniform only

Table 1: Uniform Chart

Wear and Care of the Utility and Physical Training Uniforms

PURPOSE

This lesson describes the Utility and the Physical Training uniforms. It provides information on the proper wear and care of the Utility and Physical Training uniforms. Upon completion of this lesson, you will be able to properly wear and care for the Utility and the Physical Training uniforms.

Introduction

Two of the uniforms MCJROTC cadets are required to wear are the camouflaged Utility uniform and the Physical Training (PT) uniform. Both of these uniforms are specially designed for **strenuous** work environments. Whether you are participating in field or physical exercise they are designed to serve your purposes. It is important to know the proper wear of these uniforms because there are specific **regulatory** guidelines for wear. Proper care of these uniforms insures continued service and **serviceability**.

Utility Uniforms

The camouflage utility uniform is not authorized for wear except when in the field for field-type exercises or for those work conditions where it



is not practical to wear the service uniform. An exception to this is in the Fleet Marine Forces where the wear of the utility uniform by designated units is an enhancement of readiness. The only undershirt authorized for wear with the utility uniform is the olive green crew-neck undershirt. Wearing the undershirt with the utility uniform is at the individual's option, except that the undershirt will be worn when the utility coat is removed. An undershirt may be required by the commander at such times when uniformity is considered essential such as at formations, ceremonies, or parades.

The camouflage utility uniform is designed for field wear and should be loose fitting and comfortable. Items should be fitted loosely enough to allow for some shrinkage without rendering the garment unusable. Utility uniforms may be starched or sized at the option of the individual but commanders will not **mandate** starching/sizing.

The camouflage utility coat will be worn outside the trousers. Sleeves may be rolled up at the option of local commanders. When authorized, utility sleeves will be rolled with the inside out, forming a roll about three inches wide, and terminating at a point about two inches above the elbow. When combat boots are worn, the trousers will be bloused in a neat uniform manner. When utility uniforms are prescribed for



parades, reviews, and ceremonies, the helmet with camouflage cover may be prescribed.

Name/service tapes will be worn on the utility uniform as prescribed on the green and desert utility uniforms. They will be of olive green cloth, one inch wide, with embroidered ¾ inch high black block lettering, except that tapes for the desert utility uniform will utilize brown lettering on a tan background. If necessary to accommodate longer names the lettering may be in condensed print, ½ inch high. Nametapes will include the individual's last name only in upper case letters. Service tapes will be inscribed with "U.S. MARINES" in upper case letters, with a space before "MARINES."

Tapes for utility coats will be long enough to align with the edges of the pocket flaps when the ends of the tape are turned under and stitched down. Tapes for utility trousers will not exceed six inches in length when sewn on. For the maternity camouflage work uniform both the name and service tape will be the same length. Tapes will be sewn on uniforms with the ends of the tape turned under and using a plain straight stitch with thread that matches the tape fabric.

On the utility coats, the nametape will be worn over the right breast pocket and the service tape will be worn over the left breast pocket. Tapes will be sewn with the bottom of the tape immediately above and parallel to the top of the pocket flap, with the ends of the tape aligned with the edges of the pocket flap. On coats with slanted breast pockets, a horizontal line tangent to the highest point of the pocket will be considered as the top of the pocket. On the utility trousers, a nametape will be worn above the right rear trouser pocket.

Physical Training Uniform

The required physical training (PT) uniform consists of the green general purpose trunks and the standard brown or green undershirt. The standard issue general purpose trunks are fabricated from a polyester twill fabric, are olive green in color, are of thigh length, have an elastic waist with a draw cord, and have a bound V-notch at the outer leg seams. The wear of footwear or headgear with this uniform will be as prescribed by the commander. No unit distinguishing marks or other ornamentation will be placed on the uniform. This uniform will be prescribed for all command PT activities except on those specific occasions when the commander determines that the wear of another uniform or other clothing is more appropriate.

Undergarments

Male personnel are required by regulations to wear standard underwear, either boxer or jockey style, white in color. There are no regulations regarding the style or color of undergarments for female personnel.

Being "Out of Uniform"

The wearing of the uniform should be a matter of personal pride to all Marine Corps personnel. Officers and enlisted Marines are required to maintain their uniforms and equipment in a neat and serviceable condition. By their appearance, they set an example of orderliness and conformity to uniform regulations. For these reasons, it is important that all Marines avoid being "out of uniform." Primarily, this refers to unauthorized mixing of uniform combinations. Elements of civilian clothing are not to be mixed with parts of the uniform. On the uniform itself, care must be taken to ensure that all insignia and indications of grade are correctly

positioned and aligned. Lastly, uniform components such as footwear, laces, and other elements must conform to regulation standards. Attention to the care and proper wearing of the uniform reflects the pride of individuals in the Marine Corps and themselves.

According to Marine Corps Regulations on the wear and appearance of uniforms, “all personnel will maintain a high standard of dress and appearance.” This regulation means that your personal appearance in uniform should project the image to others that you are a part of one of the finest groups in the world.

Learning how to look your best in uniform takes time and effort. Your uniform must be sized and fitted to give you comfort and a good appearance. There is nothing worse than pants, shirts, or coats that do not fit. Your pants should be hemmed to the required length and your shirt and coat, issued by size, should also fit well.

Care of Uniforms and Accessories

The distinctive uniforms you wear reflect the justifiable pride felt by members of the Marine Corps JROTC. Keeping these uniforms looking sharp on the parade field and in everyday activities means spending time in their upkeep. The uniform cannot simply be worn, put away, and forgotten until the next time it is needed. Like any other item of clothing you want to preserve, the uniform requires special care in wearing, storing, and cleaning. The following procedures are outlined to help you maintain your cadet uniform in the proper way. Following these guidelines will ensure that your cadet uniform will always look clean and neat. It will also **prolong** its life.

General Guidelines for Uniform Wear

No matter how well-fitting a uniform is when new, it will not continue to look its best unless it is well-cared for both during wear and when not in use. A uniform should be carefully put on and kept buttoned. When not in use, uniforms should be carefully placed on hangers. They should be kept in a well-ventilated storage space. Well-constructed wooden hangers shaped to fit the shoulder contour with locking trouser bars are recommended. When uniforms are folded in duffel bags or other containers for storage or shipment, they should be carefully folded. This will preserve their original shape.

Utility Uniform

Utility uniforms may be starched or sized at the option of the individual. Washing instructions, to preclude shrinking of the camouflage utility uniform, are as follows: During the washing, drying, and finishing cycles, use the lowest possible temperature setting so that at no time will the garment be exposed to temperatures greater than 130 degrees. Some laundry facilities may not press utilities due to potential damage from automated presses. Thus, any pressing required will be an individual cadet’s responsibility. Although the use of starch or sizing is authorized as an individual option, it may adversely affect the comfort and durability of the uniform.

PT Uniforms and Undershirts

Although the dyed cotton material used in PT uniforms undershirts has a strong tendency to fade, proper laundering and care will eliminate or reduce the probability of this occurring. However, fading/discoloration alone does not render the clothing unserviceable. Launder the PT uniform or undershirts using the permanent press cycle or hand wash in cold or warm water. Do not use bleach or detergents that contain bleaching agents.

Tumble dry on the permanent press cycle, drip dry on a rustproof hanger, or line dry out of the sun's direct rays. Allowing the clothing to come in contact with **oxidizing** agents, such as benzoyl peroxide (used in most acne medications) may cause spots that cannot be removed without ruining the item.

Conclusion

The Marine Corps uniform has a proud and distinctive history of identifying its wearer as a member of the finest military organization in the world. The same should be said for MCJROTC cadets. The proper wearing of the uniform should be a matter of personal pride to all cadets. Knowing that one's uniform is clean, neat, and conforming to regulations gives confidence and improves self-esteem. Achieving this, however, does require careful cleaning and storing. By following these guidelines, you will be rewarded by a uniform that projects the pride you experience as a member of the MCJROTC.❖

Wear and Care of the Service Uniforms

PURPOSE

This lesson describes the Service uniforms. It provides information on the different kinds of service uniforms as well as their proper wear and care. Upon completion of this lesson cadets will be able to describe the proper wear and care for Service uniforms.

Introduction

For most day-to-day activities, Marine personnel wear what are termed service uniforms. There are three forms of service uniforms, designated A, B, and C. Although both male and female personnel use the same designations for service uniforms, there are naturally differences between them. There are also set service uniform guidelines.

Service A Uniform: Marines wear this uniform combination when they report for duty on shore or are assigned duty as members of a court-martial. Women may wear either the long or short sleeve khaki shirt and green neck tab with this uniform. The service A uniform includes the appropriate service coat. However, when it is prescribed as the uniform of the day, it is



considered appropriate to remove the coat when inside office buildings of a military establishment.

Service B Uniform: (with long sleeve shirt and tie) is the same as the service A uniform except that the service coat is not worn. For women this uniform consists of



the long sleeve khaki shirt and green neck tab with appropriate green skirt. This uniform may be worn as the uniform of the day and for leave and liberty, unless otherwise prescribed by the commander, and may be prescribed for formations at parades or ceremonies on and off the military activity. This uniform will not be worn for formal or semi-formal social events.

Service C Uniform: This uniform consists of the quarter-length sleeve shirt with appropriate service trousers. Women may wear the green skirt. No neck tab is worn with this uniform. During the winter season, commanders may, at their discretion, authorize the wearing of the service C uniform if the weather is appropriate. This uniform may be worn as the uniform of the day, for leave and liberty (unless the commander prescribes otherwise), and in



formation at ceremonies both on and off the military activity. It shall not be worn for formal or semiformal social events.

Wearing of Slacks: Commanders may authorize female personnel to wear slacks with the service A, B, or C uniforms under the following conditions:

1. For performance of duties that require the individual to run, climb, or perform activities wherein the wearing of the skirt would be impractical or immodest.
2. When riding in a government airplane configured for cargo or driving government vehicles, such as trucks.
3. When specifically prescribed for ceremonial formations, inspections, parades, or other ceremonies.
4. Slacks may also be authorized for all women Marines under extreme weather conditions.

Undergarments

Male personnel are required by regulations to wear standard underwear, either boxer or jockey style, white in color. There are no regulations regarding the style or color of undergarments for female personnel.

Being “Out of Uniform”

The wearing of the uniform should be a matter of personal pride to all Marine Corps personnel. Officers and enlisted Marines are required to maintain their uniforms and equipment in a neat and serviceable condition. By their appearance, they set an example of orderliness and conformity to uniform regulations. For these reasons, it is important that all Marines avoid being out of uniform. Primarily, this refers to unauthorized mixing of uniform combinations.

For example, male personnel are not permitted to wear the blue trousers of the blue dress B uniform with a short sleeve khaki shirt from the service C uniform. Refer to Table 1 at the end of this chapter for an explanation of uniform combinations.

In addition, elements of civilian clothing are not to be mixed with parts of the uniform. On the uniform itself, care must be taken to ensure that all insignia, indications of grade, and medals/ribbons are correctly positioned and aligned. Lastly, uniform components such as footwear, panty hose, laces, and other elements must conform to regulation standards. Attention to the care and proper wearing of the uniform reflects the pride of individuals in the Marine Corps and themselves.

According to Marine Corps Regulations on the wear and appearance of uniforms, “all personnel will maintain a high standard of dress and appearance.” This regulation means that your personal appearance in uniform should project the image to others that you are a part of one of the finest groups in the world.

Learning how to look your best in uniform takes time and effort. Your uniform must be sized and fitted to give you comfort and a good appearance. There is nothing worse than pants, shirts, or coats that do not fit. Your pants should be hemmed to the required length and your shirt and coat, issued by size, should also fit well.

Care of Uniforms and Accessories

The distinctive uniforms they wear reflect the justifiable pride felt by members of the MCJROTC. Keeping these uniforms looking sharp on the parade field and in everyday activities, means spending time in their upkeep.

The uniform cannot simply be worn, put away, and forgotten until the next time it is needed. Like any other item of clothing you want to preserve, the uniform requires special care in wearing, storing, and cleaning. The following procedures are outlined to help you maintain your cadet uniform in the proper way. Following these guidelines will ensure that your cadet uniform will always look clean and neat. It will also prolong its life.

General Guidelines for Uniform Care

No matter how well-fitting a uniform is when new, it will not continue to look its best unless it is well-cared for both during wear and when not in use. A uniform should be carefully put on and kept buttoned. When not in use, uniforms should be carefully placed on hangers. They should be kept in a well-ventilated storage space. Well-constructed wooden hangers shaped to fit the shoulder contour with locking trouser bars are recommended. When uniforms are folded in duffel bags or other containers for storage or shipment, they should be carefully folded. This will preserve their original shape.

Heat, friction, and pressure have a deteriorating effect on materials. As all these factors are present and necessary for properly pressed uniforms, service uniforms generally show more wear at creased areas. Periodically pressing out old creases and reforming them slightly to either side of the previous crease will prolong the condition of these areas. Sleeve cuffs and trouser hems should be periodically examined and turned if material permits. Dry cleaning preserves the original appearance and finish of wool and wool-polyester garments. Dry cleaning is recommended over hand laundering. When dry cleaning facilities are not available, and only as a last resort, wool and wool-polyester uniforms may be hand

laundered. Hand launder with a neutral soap and fresh lukewarm water 70 to 80 degrees. If hard water is used, a little amount of water softener should be added to the water. In laundering, thick suds are necessary for best results. The soap should be thoroughly dissolved in hot water and added to the cool water to reach a temperature of approximately 70 to 80 degrees. In order to preserve the finish, rubbing should be held to a minimum. Thorough rinsing is necessary to remove all traces of the soap. Use plenty of clear water in the rinse.

After washing the garments, squeeze gently to remove surplus water, shape garment by hand, and dry in open air. Colored garments should not be hung in the sun to dry. If this is unavoidable, garments should be turned inside out to dry. In laundering, avoid high temperature, friction, and pressure as much as possible. Never run through a wringer or twist uniforms to remove the excess water before drying. Never use chlorine bleaches on wool and wool-polyester materials. Also, uniform items manufactured of polyester-cotton should not be bleached or starched.

Prevention of Moth Damage

Frequent brushing and exposure to sunshine and fresh air will effectively prevent moths. If uniforms are to be put away for a long period of time and left undisturbed, they should be thoroughly cleaned and packed in an airtight plastic bag. They can also be protected from moth damage with camphor balls, naphthalene, cedar wood, or paradichlorobenzene.

Care of Buttons and Insignia

Gold buttons are gold-plated to prevent tarnishing. They should not be polished with

abrasives or polishing cloths containing chemicals. Gold buttons should be cleaned with a weak solution of household ammonia and water. Gold-plated buttons that have had the plating removed are likely to turn green due to exposure to moist air. This is due to copper salt forming on the copper base of the buttons. It can be removed by rubbing gently with acetic acid or any substance containing this acid, such as vinegar, followed by a thorough washing in fresh water and drying.

The gold filled parts and the sterling silver rhodium finished parts of metal insignia are cleaned by washing with soap and water. Avoid using silver polish or abrasives.

Service insignias will not be polished. Should continued use cause loss of the desired finish, the insignia should be replaced. It could also be refinished with USMC approved liquid, black protective coating as sold through the Marine Corps exchange. The use of paints or other coloring agents not so authorized is prohibited.

Care of Footwear

Continual maintenance of leather footwear is necessary to ensure optimum wear. It is also needed to adequately protect the healthy, sanitary condition of the feet. When not in use, the shape of the shoes should be maintained by the use of shoetrees. Foot powder should be liberally sprinkled inside the shoe to absorb moisture and excessive perspiration. Constant inspection of footwear is necessary to ensure prompt repair in order to avoid breakdown of the upper leather.

Shoes should be kept scrupulously clean of sand, dirt, and grit. Such dirt has an excessively deteriorating action on shoe threads and shoe leather. Leather uppers should be periodically

cleaned with a saddle soap that is a well-recognized leather preservative. Dubbing should never be used on footwear as such compounds seal the pores of the leather and cause excessive perspiration.

Cordovan leather shoes do not normally attain the high luster obtainable on calfskin shoes due to high oil content. This may be gradually overcome by regular applications of saddle soap to remove excess oils. Leading manufacturers of cordovan shoes often furnish detailed polishing instructions at time of purchase.

For normal care, synthetic shoes may be cleaned by wiping with a damp cloth or sponge. Regular shoe polish may be used to heighten shine. Occasional polishing with paste wax or cream polishes may be required; however, excess dust and dirt should be removed before polishing. Liquid polish may be used but care should be taken to avoid streaking. Apply polish with a good polish brush in moderate amounts. To cover abrasion or scuff marks, apply a paste wax shoe polish and then buff wax.

All stains should be wiped off as quickly as possible, and the shoes then cleaned. For stubborn stains, try lighter fluid. A mild abrasive cleaner may be used if rubbed gently. Do not use chlorinated cleaners, bleaches, or harsh abrasives. The dyeing of synthetic shoes is not recommended. For cleaning, never use acetone, nail polish remover, chlorinated dry cleaning solvents, or alcohol. When in doubt about a cleaner or polish, try a little on the instep close to the sole as a test area.

Conclusion

The Marine Corps uniform has a proud and distinctive history of identifying its' wearer as a member of the finest military organization in the world. The proper wearing of the uniform should

be a matter of personal pride to all cadets. Knowing that one's uniform is clean, neat, and conforming to regulations gives confidence and improves self-esteem. Achieving this, however, does require careful cleaning and storing. Likewise, buttons, insignia, and footwear have special procedures for their upkeep. By following these guidelines, you will be rewarded by a uniform that projects the pride you experience as a member of the MCJROTC.❖

Uniform Explanation Chart

UNIFORM COMBINATION	DESCRIPTION	OCCASIONS FOR WEAR
Service A	Green coat and trousers/skirt/slacks w/ribbons	Parades, ceremonies, social events and uniform of the day
Service B	Long-sleeve shirt w/green trousers/skirt/slacks	Parades, ceremonies, and uniform of the day
Service C	Short-sleeve shirt w/green trousers/skirt/slacks	Parades, ceremonies, and uniform of the day

Table 1: Uniform Chart

The Salute: A Sign of Respect

PURPOSE

This lesson is to make you aware of the importance of the hand salute. As a MCJROTC cadet, you should be able to know how and when to execute a proper hand salute.

Introduction

The history of **saluting** has many plausible origins. Some believe that during the Age of Chivalry when two knights met, they raised their visors to expose their faces. This allowed them to recognize their allies vs. their enemies. The raising of the visor was always performed with the right hand. During the Middle Ages, men wore heavy capes to conceal their swords. When two men would greet each other, they would raise their right arm to show that it was not on the sword hilt. Greeting someone without raising your right arm could potentially mean that you are about to attack.



Saluting an officer at six paces.

The current salute used by the Marine Corps personnel has its origins from the British Navy, who in turn borrowed their hand salute from the British Army. British as well as French soldiers salute with their right hand turned

outward. Some believe that this custom allowed the person being greeted to see that there was no weapon in the hand of the person.

Since the first days of military organizations, juniors have always uncovered when addressing seniors. This was done by touching the hat or cap with the right hand or taking it off. If the person were not wearing a hat or cover, they would grab a lock of hair.

In the late nineteenth century, Queen Victoria decreed that the hand salute was to be used instead of taking your hat or cap off. This decree came about because military members would uncover in the presence of the queen during official ceremonies, which was considered unsatisfactory.

Hand Salute

The hand salute is one of the most recognizable courtesies of the military way of life. Ages ago, the salute was a greeting that indicated you were not holding a weapon in your hand. Today, it is a way to show respect.



Hand salute.

Whom to Salute

You must render the salute to all commissioned and warrant officers. Generally, you do not salute noncommissioned officers or

petty officers; however, there are exceptions. For example, when you act as a squad leader, salute your platoon sergeant when making reports.

How to Salute

When a leader who is in charge of a formation commands “*present, arms,*” you should execute a salute. If you are not carrying a rifle, you can give the hand salute in three different ways depending upon whether you are wearing headgear, glasses, or both.

When wearing headgear with a visor (with or without glasses), raise your right hand sharply, fingers and thumb extended and joined, palm facing down. Place the tip of your right forefinger on the rim of the visor slightly to the right of your right eye. Barely turn the outer edge of your hand downward so neither the back of your hand nor the palm is clearly visible from the front. Keep your hand and wrist straight, your elbow inclined slightly forward, and the upper arm horizontal.



Hand Salute Wearing Headgear with a Visor

When wearing headgear without a visor, and without glasses, execute the hand salute in the same manner as previously described, except touch the tip of your right forefinger to the forehead near and slightly to the right of your right eyebrow.



Hand Salute without a Visor or Glasses

When wearing headgear without a visor, and with glasses; execute the hand salute in the same manner as above, except touch the tip of your right forefinger to that point on the glasses where the temple piece of the frame meets the right edge of your right brow.



Hand Salute with Glasses (without a Visor)

When reporting or rendering a courtesy to an individual, turn your head and eyes toward the person and simultaneously salute. In this situation, execute the actions without command. The subordinate initiates the salute at the appropriate time and terminates it upon acknowledgment.

When to Salute

Military regulations on conduct require you to salute even when carrying a rifle and when you meet and recognize a person entitled to the honor. However, you are not required to salute under the following conditions:

- When on public transportation, including buses and trains
- When in public places such as stores and theaters
- While indoors except when reporting to an officer or when on duty as a guard
- When one or both parties are in civilian clothes

Conditions under which you must salute are:

- When you hear the national anthem, “To The Colors” or “Hail to the Chief” (if you are in uniform)
- When the national colors pass you
- During all official **greetings**
- During reveille and retreat, when within sight of the flag or the sound of the music and in uniform
- During the rendering/sounding of honors

When pledging allegiance to the flag while outdoors and in uniform. (Indoors in uniform requires that you stand at attention and face the flag, but you do not salute. Indoors in civilian clothing requires that you stand at attention, face the flag, and place your right hand over your heart.)

Conclusion

The MCJROTC, like the USMC, follows **customs**, courtesies, and **traditions** that play an extremely important role in building morale, esprit de corps, and **discipline**. Whatever the origin of the present day hand salute you subscribe to, it is extremely important that you are able to render and properly return a hand salute. Failure to do so, not only reflects negatively on you as a cadet, but on the Corps as well. ❖

Rendering Salutations

PURPOSE

*This lesson will make you aware of the importance of proper **salutations**, using correct titles to show respect and rank. As a MCJROTC cadet, you should know how and when to render a proper salutation to a senior.*

Introduction

Military courtesy is a form of politeness in the honorable profession of arms. Courtesies honor people with actions or words to show respect, authority, and achievement. It is a disciplined attitude of the mind. The use of titles and salutes are two courtesies that honor members of the military. Just as the rendering of a hand salute says in effect, “I greet you,” it is customary to say, “Good morning, **sir/ma’am**,” or “Good afternoon, sir/ma’am” when saluting an officer. Webster’s dictionary defines salutation as “an expression of greeting, goodwill, or courtesy by word, gesture, or ceremony.” Just as a MCJROTC cadet salutes proudly and **smartly**, the proper salutation shows the cadet has confidence in his or her abilities as cadet.



Saluting when overtaking an officer.

The Greeting

The customary greeting given along with the salute is:

- From early morning to noon: “Good Morning, _____.”
- From noon to evening meal: “Good Afternoon, _____.”
- From evening meal until retiring: “Good Evening, _____.”

When overtaking an officer who is going in the same direction as you, come side by side to the left of the officer, salute and say, “By your leave sir or ma’am.” The officer will return the salute and say, “Carry-on” or “Granted.” You then finish your salute and pass ahead.

When encountering people whom you know by name, it is courteous to say, “Good morning, Major Jones” or “Good Evening, Cadet Smith.” Similarly, they should respond with your name if they know it. Doing so personalizes the greeting. You are encouraged to use names as much as possible in place of the mechanical “Sir/Ma’am.”

Addressing Seniors and Juniors

Whenever you are having a conversation with a senior, always remember that the use of the word “sir” is very important. The omission of “sir” may lead to a reprimand on the spot, or mentioned later. If you are in a senior position, address your juniors by their proper titles and names. This helps to build a relationship with your subordinates based on respect. However, keep in mind that the over-casual use of first names and nicknames can be risky and is liable to

compromise your position. In addition, as a senior, you should not allow a junior to use any disrespectful reference to an absent third party.

Military Titles

In conversation or on unofficial occasions, it is proper to use shortened titles. For example, medical and dental officers below the rank of commander may be addressed as “Doctor.” Any chaplain may be address by another officer as “Padre;” and, Roman Catholic chaplains of any rank as “Father.” Although it is no longer a regulation, addressing a second lieutenant as “Mr.” is customary; however, in the presence of enlisted personnel, the title “Lieutenant” should be used. Lieutenant colonels are addressed as “Colonel.” Generals and admirals of whatever grade are spoken to as “General” or “Admiral.”

Displayed are the correct titles by which you should address most individuals in the MCJROTC and military.

Master Sergeant, First Sergeant and Master Gunnery sergeants should always be addressed by their rank and not by “Top”.

<u>Title</u>	<u>How to Address</u>
All general officers	“General”
Colonels and Lieutenant	
Colonels	“Colonel”
Majors	“Major”
Captains	“Captain”
First Lieutenants	“Lieutenant”
Second Lieutenants	“Lieutenant”
Chaplains	“Chaplain”
Cadets	“Mister,” “Miss” or “Cadet”
Officer Candidates	“Candidate”
Warrant Officers	“Warrant Officer”
Sergeant Majors	“Sergeant Major”
Master Gunnery Sergeants	“Master Gunnery”
First Sergeants	“First Sergeant”
Master Sergeants	“Master Sergeant”
Gunnery Sergeants	“Gunnery Sergeant”
Staff Sergeants	“Staff Sergeant”
Sergeants	“Sergeant”
Corporals	“Corporal”
Privates First Class	“PFC”
Privates	“Private”

If you do not know the person’s name, you may address them as follows:

All medical officers	<i>by their rank</i>
Male officers	“Sir”
Female officers	“Ma’am”

Conversation with others in the military should be formal and correct. Use proper titles to show respect and indicate rank. Senior MCJROTC cadets may address junior MCJROTC cadets by their first name, but not the other way around.

Where a male officer is addressed as “sir,” a woman officer will be addressed as “ma’am.” She may also be spoken to by rank, such as “Yes, Major,” or “Good evening, Lieutenant.” Female nurses below the grade of commander and women warrant officers may be informally addressed as “Miss” or “Mrs.”

Miscellaneous

The following is a group of written and unwritten customs and courtesies, all of which are important to know and observe.

When a commanding officer says, “I would like,” “I wish,” or a similar expression, it has the force of a direct order and should be observed as such. In addition, when an officer or enlisted person receives orders or instructions, the individual should reply with “**Aye, aye, sir,**” or “Yes, sir.” This is saying, “I understand the orders I have received, and will carry them out.” Never should “OK,” “Very well,” or “All right” be used as a substitute.

When you meet a senior indoors, either in a passageway or on a stairway you should give way smartly and promptly. When a senior enters a room or passes close to one or more unorganized groups whether indoors or outdoors, the senior officer or NCO of the group commands, “Attention.” All hands come to attention and remain so until the senior passes. If outdoors and **covered** (wearing headgear), then all hands salute.

Conclusion

The principles of military courtesy are not only applicable to the military, but also to the MCJROTC. By the time you have been a MCJROTC cadet for a while, your practice of showing respect to military seniors will be almost automatic. Thus, practicing military courtesy should become routine behavior for every cadet. Such things as saying “Sir/Ma’am” will become instinctive. ❖

Marines' Hymn

PURPOSE

This lesson introduces you to the Marines' Hymn. It provides information on the history and traditions that the hymn is based upon.

Introduction

Webster's dictionary defines hymn as "a song of praise to somebody or something other than a deity." Hymns have been an important part of American music culture - mainly religious music - since the first Europeans set foot on the shores of the new world. Many of these early settlers from Europe came to the new world to escape religious persecution. These settlers brought with them religious hymns from all over the world. Just as religious hymns are songs of praise so is the Marines' Hymn.

Early Influences

The Marines' hymn is the oldest of the official songs of the U.S. Armed Services and is steeped in Marine Corps history. In 1805, a small force of Marines stormed the Barbary pirates' stronghold at Derna on the "shores of **Tripoli**," and hoisted the American flag for the first time over a fortress of the Old World. Afterward, the Colors of the Corps were inscribed with the words: "To the Shores of Tripoli." During the Mexican War of 1847, Marines captured and occupied the Castle of Chapultepec, otherwise known as the "Halls of Montezuma." The words on the Colors were changed to read: "From the Shores of Tripoli to the Halls of Montezuma."

Following the close of the Mexican War, somewhere around 1849, came the first verse of the Marines' Hymn. It was written, according to legend, by a Marine on duty in Mexico and sung to a Mexican folk tune. The unknown author transposed the phrases in the motto on the Colors so that the first two lines of the Hymn would read: "From the Halls of Montezuma, to the Shores of Tripoli."



John Philip Souza (1852-1932)

Souza was a famous American bandmaster and composer. At age 13, his father enlisted him in the Marines as an apprentice to the U.S. Marine Corps Band, the official band of the President of the United States. Appointed as leader of the band in 1880, he raised the level of performance and instrumentation of the band to a higher standard in his 12 years as bandmaster. His marches were recognized as distinctly American as well as brilliant and stirring. One Souza's march songs that all Marines have come to know is, "Semper Fidelis" (1888) along with "The Stars and Strips Forever" (1897).

Serious attempts to trace the tune of the Marines' Hymn have led to no conclusive answer. John Philip Souza, a famous **bandmaster** and composer, believed that the melody of the hymn was taken from Jacques Offenbach's comic opera,

“Genevieve de Brabant.” Many music scholars’ agree that the melody of the Marines’ Hymn was taken from “Genevieve de Brabant”.

French Connection

Many interesting stories have been associated with the Marines’ Hymn. One of the best was published in the *Stars and Stripes*, the official newspaper of the American Expeditionary Force, dated August 16, 1918.

A wounded officer from among the gallant French **lancers** had just been carried into a Yankee field hospital to have his dressing changed. He was full of compliments and curiosity about the dashing contingent that fought at his regiment’s left.

A lot of them are **mounted troops** by this time, he explained, for when our men would be shot from their horses, these youngsters would give one running jump and gallop ahead as cavalry. I believe they are soldiers from **Montezuma**. At least, when they advanced this morning, they were all singing ‘From the Halls of Montezuma to the Shores of Tripoli.’

First Official Version

In 1929, the Commandant of the Marine Corps authorized the following verses of the Marines’ Hymn as the official version:

*From the halls of Montezuma
To the Shores of Tripoli;
We fight our country’s battles
On the land as on the sea;*

*First to fight for right and freedom
And to keep our honor clean;
We are proud to claim the title
of United States Marine.*

*Our flag’s unfurled to every breeze
From dawn to setting sun;
We have fought in ev’ry clime and place
Where we could take a gun;*

*In the snow of far-off Northern lands
And in sunny tropic scenes;
You will find us always on the job--
The United States Marines.*

*Here’s health to you and to our Corps
Which we are proud to serve
In many a strife we’ve fought for life
And never lost our nerve;*

*If the Army and the Navy
Ever look on Heaven’s scenes;
They will find the streets are guarded
By United States Marines.*

Changes to the Hymn

On November 21, 1942, the Commandant of the Marine Corps approved a change in the words of the fourth line, first verse, to read, “In air, on land, and sea.” Former Gunnery Sergeant H. L. Tallman, a veteran observer in Marine Corps Aviation and participant in combat missions with Marine Corps Aviation over the Western Front in World War I, had first proposed the change.

Every campaign the Marines have taken part in gives birth to an unofficial verse. For example, the following from Iceland:

*Again in nineteen forty-one
We sailed a north'ard course
And found beneath the midnight sun,
The Viking and the Norse.
The Iceland girls were slim and fair,
And fair the Iceland scenes,
And the Army found in landing there,
The United States Marines.*

Conclusion

The Marines' Hymn has been sung and played wherever U.S. Marines have landed, and today is recognized as one of the foremost military service songs.

Copyright ownership of the Marines' Hymn was vested in the United States Marine Corps per certificate of registration dated August 19, 1991, but it is now in the public domain. ❖

A Symbol of Pride

PURPOSE

*This lesson introduces you to the Marine Corps **emblem**. It provides information on the basic design and identifies the three parts that comprise the emblem.*



In 1776, the device consisted of a “**foul anchor**” of silver or pewter that still forms a part of the emblem today. (A foul anchor is an anchor that has one or more turns of the chain around it). Changes were made in 1798, 1821, and 1824. In 1834, it was prescribed that a brass eagle be worn on the hat -- the eagle to measure 3 ½ inches from wingtip to wingtip.

During the early years, numerous distinguishing marks were prescribed, including “black cockades, “**scarlet** plumes,” and “**gold** bands and tassels.” In 1859, the origin of the present color scheme for the officer’s dress uniform ornaments appeared on an elaborate device of solid white metal and gold metal. The design included a United States shield, half wreath, a bugle, and the letter “M.”

In 1868, Brigadier General Commandant Jacob Zeilin appointed a board “to decide and report upon the various devices of cap ornaments for the Marine Corps.” On November 13, 1868, the board turned in its report. It was approved by the Commandant four days later, and on November 19, 1868, it was signed by the Secretary of the Navy.

The emblem recommended by this board has survived with minor changes to this day. It consists of a **globe** (showing the Western

Introduction

Emblems appear in every segment of our daily life. Everywhere one turns, some form of an emblem touches our range of vision. Webster’s dictionary defines emblem as, “an object or representation that functions as a symbol.” The Marine Corps emblem is a symbol of years of traditions and customs that are written and unwritten. As a MCJROTC cadet, you get to proudly wear the emblem that is steeped in history and sets you apart from all other military services.

Eagle, Globe & Anchor

The history of the Marine Corps emblem is a story related to the history of the Corps itself. The emblem of today traces its roots to the designs and **ornaments** of early Continental Marines as well as British Royal Marines. The emblem took its present form in 1868. Before that time many devices, ornaments, and distinguishing marks followed one another as official marks of the Corps.

Hemisphere) intersected by a fowl anchor, and surmounted by a spread eagle. The eagle proudly carries a streamer in its beak, which bears the Latin motto “**Semper Fidelis**” (Always Faithful). The uniform ornaments omit the motto ribbon.



Marine Corps Emblem

The general design of the emblem was probably derived from the British Royal Marines’ “Globe and Laurel.” The globe on the U.S. Marine emblem signifies service in any part of the world. The eagle also indirectly signifies service worldwide, although this may not have been the intention of the designers in 1868. The eagle they selected for the Marine emblem is a crested eagle, a type found all over the world. On the other hand, the eagle pictured on the great seal and the currency of the United States is the bald eagle, strictly an American variety. The anchor, whose origin dates back to the founding of the Marine Corps in 1775, indicates the amphibious nature of Marines’ duties.

Conclusion

Whether you are a private or a general is secondary compared to the privilege you, as a MCJROTC cadet, share in wearing the emblem. It is a symbolic representation of what the Corps stands for, past and future. The eagle, globe, and anchor is the most important insignia you have and should be worn with pride. ❖

British Royal



Marines Emblem

Marine Corps Birthday

PURPOSE

The purpose of this lesson is to inform you of the importance of celebrating the Marine Corps birthday. As a MCJROTC cadet, you should know when, where, and how the Marine Corps was founded.



Introduction

Everyone likes a “birthday party” with fellowship, good cheer, and an opportunity to celebrate a special event with friends. Just as the MCJROTC cadets enjoy a good birthday party, so do U.S. Marines around the world in commemorating the Marine Corps birthday. Starting in the summer, the Marine Corps begins preparations for its “birthday party,” and activities become more feverish as the fall approaches. By early November every Marine is either rehearsing his or her role in the “party,” or polishing, and spit shining in order to appear at his or her best for event.

Historical Background

Formal commemoration of the birthday of the Marine Corps began on November 10, 1921. The date was chosen because on November 10, 1775, the **Continental Congress**, meeting in Philadelphia, at **Tun Tavern**, authorized the raising and enlistment of two battalions of **Continental Marines**. The Marines were formed to serve with the newly formed naval forces of the colonies. Tun Tavern became known as the birthplace of the Corps.

However, this has not always been the case. In fact, Marines have not always celebrated their founding on November 10.

Until 1921, the birthday of the Corps had been celebrated on another date. An unidentified newspaper clipping from 1918 refers to the celebration of the 120th birthday of the Marine Corps on July 11 “as usual with no fuss.” It is doubtful that there was any real celebration at all. Further inspection of documents and publications prior to 1921 shows no evidence of ceremonies, pageants, or parties. The July date was commemorated between 1798 and 1921 as the birthday of the Corps. During the Revolution, Marines had fought on land and sea, but at the close of the Revolution the Marine Corps and the Navy were all but disbanded. On July 11, 1798, President John Adams approved a bill that recreated the Corps, thereby providing the rationale for this day being commemorated as the birthday of the U.S. Marine Corps.

On October 21, 1921, Major Edwin McClellan, officer-in-charge, Historical Section, Headquarters Marine Corps, sent a memorandum to Major General Commandant John A. Lejeune suggesting that the original birthday on November

10, 1775, be declared a Marine Corps holiday. McClellan further suggested that a dinner be held in Washington to commemorate the event. Guests would include prominent men from the Marine Corps, the Army, and the Navy, and descendants of the Revolution.

Accordingly, on November 1, 1921, Lejeune issued Marine Corps **Order No. 47**, Series, 1921. The order summarized the history, mission, and tradition of the Corps and directed that it be read to every command on November 10 each subsequent year in honor of the birthday of the Marine Corps. This order has been duly carried out.

The first so-called “Birthday Ball” was probably held in 1925 in Philadelphia. No records have been located of one before 1925. It is not possible to determine precisely when the first cake ceremony was held, but the first on record was held at Marine Barracks, Washington, D.C. In 1937, Major General Commandant Thomas Holcomb presided at an open house for Marine Corps officers. Ceremonies included the cutting of a huge cake designed after the famous Tun Tavern in Philadelphia. The oldest and youngest Marines present received the first and second pieces of the cake.

Conclusion

At present, celebrations of the Marine Corps Birthday on November 10 differ at posts and stations throughout the Corps. All commemorations include the reading of Marine Corps Order 47 and the Commandant’s Message to those assembled. Most commands sponsor a birthday ball of some sort, complete with pageant and cake ceremony as prescribed in the Marine Corps Manual. ❖

The United States Flag – Colors of Pride

PURPOSE

The purpose of this lesson is to make you aware of the importance of properly displaying the National, State and Organizational flags.

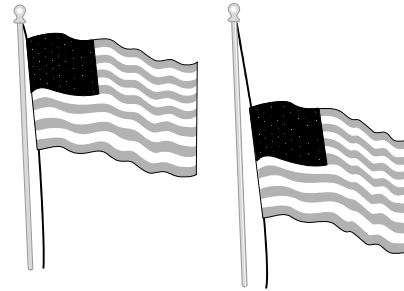

Introduction

Due to the symbolic nature of the flag, justice, unity, and pride in your country, you should honor it with respect and dignity. Even after the flag becomes old and worn, you should not use it for banners or in any disrespectful way. If you do not preserve it, you should destroy it as a whole, privately, respectfully, and traditionally by burning. Always show the flag the utmost respect, whether you are in uniform or in civilian attire.

Rules for Displaying the U.S. Flag

When displaying the flag, you should always raise it briskly and lower it ceremoniously. It is customary to display the flag from sunrise to sunset, but you can display all-weather flags at all times if properly lit at night. The use of the flag at night, as well as during the day, should follow rules of custom.

Presidential proclamations contain the rules for displaying the flag at **half-staff** -- for example, on Memorial Day, we display the flag at half-staff until noon, and then raise it to the top of the **staff**. State and federal governments also fly the flag at half-staff when there is death of a president, former president, principal official, or foreign dignitary.

When flying the flag at half-staff, first raise it to its peak, and then lower it to the half-staff position. When lowering the flag for the day after it has been flown at half-staff, first raise it to its peak, and then lower it ceremoniously.

Executive Orders

- On June Act of January 13, 1794 - provided for 15 stripes and 15 stars after May 1795.
 - Act of April 4, 1818 - provided for 13 stripes and one star for each state, to be added to the flag single point of each star to be upward.
 - Executive Order of President on the 4th of July following the admission of each new state signed by President Monroe.
 - Executive Order of President Taft dated June 24, 1912 - established proportions of the flag and provided for arrangement of the stars in six horizontal rows of eight each.
 - Eisenhower dated January 3, 1959 - provided for the arrangement of the stars in seven rows of seven stars each, staggered horizontally and vertically.
 - Executive Order of President Eisenhower dated August 21, 1959 - provided for the arrangement of the stars in nine rows of stars staggered horizontally and eleven rows of stars staggered vertically.
-

Folding the Flag Correctly

Illustrated below is the correct procedure for folding the U.S. flag.

1. Bring the lower striped section of the flag up over the blue field.

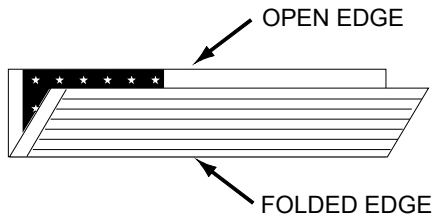

2. Then, fold the “folded edge” over to meet the “open edge.”

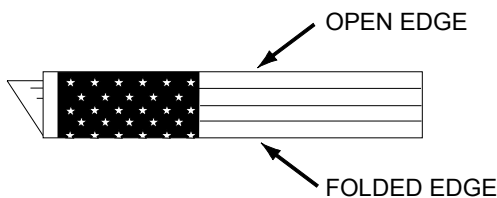

3. Start a triangular fold by bringing the lower striped corner to the “open edge”.

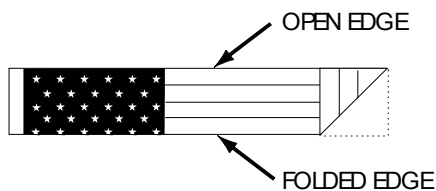

4. Fold the outer point inward and parallel with the “open edge” to form a second triangle.



5. Continue to fold the flag in triangles until the entire length of the flag is folded with only the blue field and the margin showing.



6. Tuck the margin into the pocket formed by the folds at the blue field edge of the flag.



7. When you have completely folded the flag, only the blue field should be visible, and it should have the triangular shape of a cocked hat.



Display of the U.S. Flag Alone

Display the U.S. flag alone according to the following guidelines:

- When displaying the national flag from a staff projecting from a windowsill, balcony, or front of a building, the **union** of the flag should be at the staff’s peak (unless displaying the flag at half-staff).

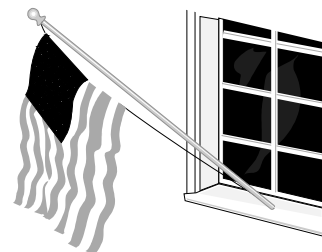

U.S. MARINE CORPS. JROTC
Category 5 – General Military Subjects
Skill 4 – Customs, Courtesies, and Traditions

- When displaying the flag flat against a wall, either horizontally or vertically, the union should be upper most and to the flag's own right, or the observer's left.

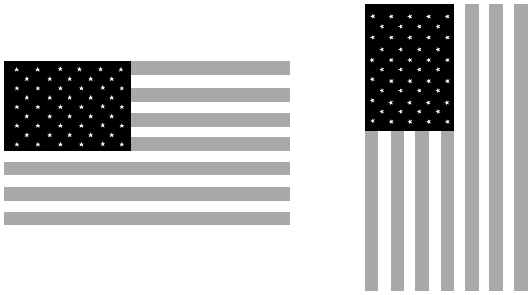

- When suspending the flag at the edge of a sidewalk on the side of a building, raise the flag out from the building towards the pole, union first.

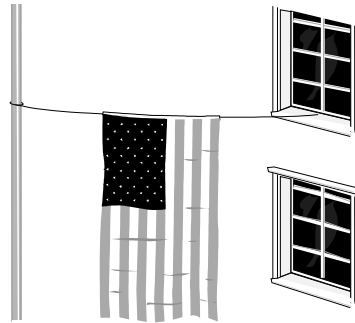

- When displaying the flag in a window, place it with the union to the left of the observer in the street.

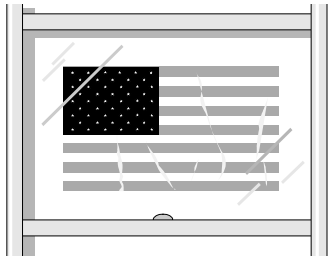

- When using the flag over a casket, place it so the union is at the head and over the left shoulder.

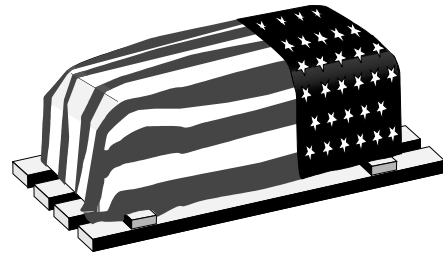

- When displayed suspended across a street, the flag should be vertical, with the union to the north on an east-west street, or to the east on a north-south street.

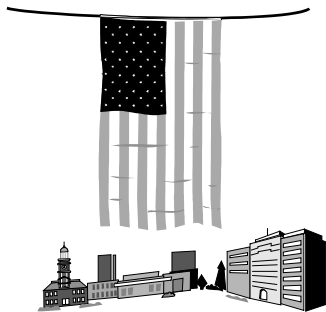

Note: Never lower the flag into the grave, nor allow it to touch the ground.

Group Display

Display a group of flags according to the following guidelines:

- When displaying the flags of two or more nations or states, fly them from separate flag staffs (or flagpoles) of the same height. The flags should be of similar size.

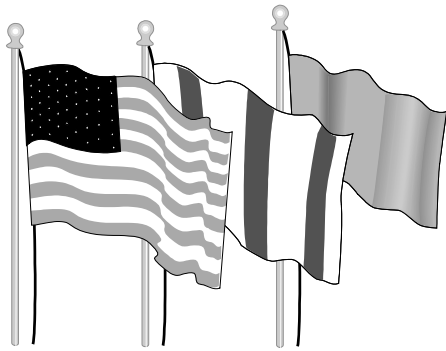

- When grouping a number of flags and displaying them from staffs radiating from a central point, center the national flag or place it at the highest point of the group.

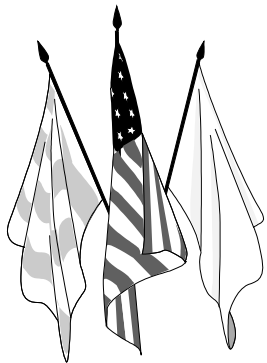

- When carried in a **procession** with other flags, carry the national flag either on the far right of the row of marching persons or, if in a line of flags, carry it in the front and center position of that line.

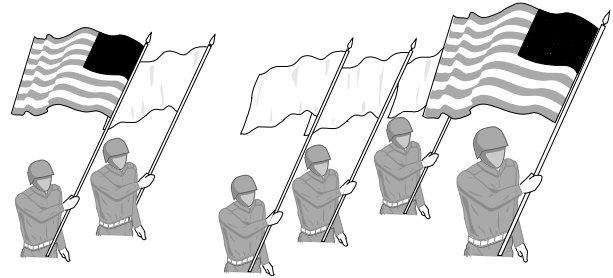

- When flying a **pennant** or another flag on the same **halyard** with the national flag, always fly the national flag at the peak of the staff. The only exceptions to this rule are displaying the United Nations flag at the United Nations Headquarters or the church pennant during services at sea.

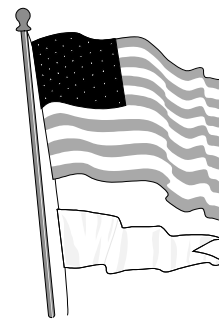

- When displaying the national flag with another flag from a crossed staff, place the national flag on its right with its staff in front of the staff of the other flag.

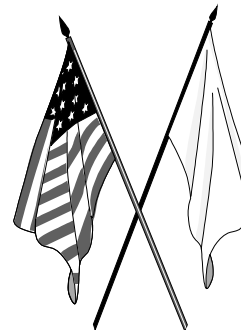

- When displaying the national flag from a staff in an auditorium, meeting hall, or chapel,

whether on the same floor level or on a platform, it should be in the position of honor at the speaker's or chaplain's right facing the audience or congregation. Place other flags on the left of the speaker or chaplain; that is, to the right of the audience.

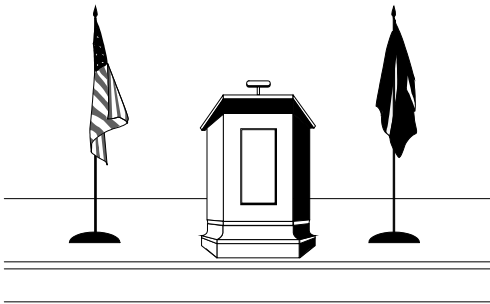

Flag Laws and Regulations

By Executive Order, the flag flies 24 hours a day at the following locations:

- The Betsy Ross House, Philadelphia, Pennsylvania
 - The White House, Washington, D.C.
 - U.S. Capitol, Washington, D.C.
 - Washington Monument, Washington, D.C.
 - Iwo Jima Memorial to U.S. Marines, Arlington, Virginia
 - Battleground in Lexington, MA (site of first shots in the Revolutionary War)
 - Winter encampment cabins, Valley Forge, Pennsylvania
 - Fort McHenry, Baltimore, Maryland (a flag flying over Fort McHenry after a battle during the War of 1812 provided the inspiration for The Star-Spangled Banner)
 - The Star-Spangled Banner Flag House, Baltimore, Maryland (site where the famed flag over Fort McHenry was sewn)
 - Jenny Wade House in Gettysburg, Pennsylvania (Jenny Wade was the only civilian killed at the battle of Gettysburg)
 - U.S.S. Arizona Memorial, Pearl Harbor, Hawaii
 - All custom points and points of entry into the United States
-

Marine Corps Colors and Standards

The commandant issues to every major Marine unit or organization a distinguishing flag that is carried beside the National Color. These unit flags are called Marine Corps Colors (or Standards). A Marine Corps Color bears the emblem and motto of the Corps and the unit title. It follows the color scheme of the Corps, scarlet and gold.



Organizational Battle Color (Standard)

The Marine Corps Color of a Fleet Marine Force unit is called the unit Battle Color. The color authorized for an organization in the Supporting Establishment (such as a Marine Barracks) is called the Organization Color.



Guidon

The Guidon is a small rectangular scarlet flag measuring 22 by 28 inches with the Corps badge in silhouette in the center in yellow. Organization Guidons carry the Marine Corps emblem and the title of the unit. Dress Guidons

(used as markers) simply bear the initials “USMC.” Companies, batteries, or detachments, carry a type I guidon. This design was adopted by a set of specifications issued on January 25, 1939.

Guidons are carried on all occasions of ceremony when a company or equivalent unit is represented by two or more platoons. In garrison, they may be displayed outside the company headquarters between the hours of morning and evening colors except in inclement weather or when the company is using the guidon in formation.



Commandant of the Marine Corps

Commandant of the Marine Corps

The Commandant of the Marine Corps has the only personal flag among the chiefs of the five armed forces that is not divided diagonally into two colors. The basic design of this flag dates back into at least the 1920s, when the Commandant, then the only major general in the Corps, flew a scarlet flag with the eagle, globe, and anchor badge in yellow above two white stars. As the grade of the Commandant was increased in World War II, stars were added to this basic design as reflected in the flag today.

Every active general officer in command displays a **Personal Flag**. Marine Corps personal

flags consist of a scarlet field with white stars, according to the officer’s rank, arranged in the same manner as the stars on Navy personal flags. Regulations governing personal flags are in Navy Regulations and Marine Corps Flag Manual.

Flag Holidays

The flag should be displayed, from sunrise to sunset, on all days when the weather permits, especially on:

- New Year's Day,
- Inauguration Day,
- Martin Luther King's Birthday,
- Lincoln's Birthday,
- Washington's Birthday,
- Easter Sunday,
- Patriots Day, April 19,
- National Day of Prayer, the 1st Thursday of May,
- Mother's Day,
- Armed Forces Day,
- Memorial Day (**half-staff until noon**),
- Flag Day,
- Independence Day, July 4th,
- Labor Day,
- Constitution Day,
- Columbus Day, October 12th,
- Navy Day,
- Veterans Day,
- Thanksgiving Day,
- Christmas Day,
- Election Days,
- State and Local Holidays,
- And such other days as may be proclaimed by the President of the United States.

Conclusion

The flag of the United States has a rich heritage and interesting history, from the original Stars and Stripes to the present-day 50-star version. It represents an independent nation. The traditions that it symbolizes will continue to exist as long as citizens treat the national flag with the respect it deserves. ❖

Pledge of Allegiance

PURPOSE

*The lesson will inform you of the importance of reciting the Pledge of **Allegiance**. As a MCJROTC cadet, you should know the origin and meaning of the words of the pledge and the proper response when in uniform or civilian cloths.*

Introduction

Each day across America, millions of students recite the Pledge of Allegiance along with thousands of citizens at meetings of Boys Scout, Girl Scout, American Legion and other organizations. Most do so out of repetition with no idea of the origin or meaning of the Pledge. While most of us know the words of the Pledge, there are a large number who do not know of its origin.

400th Anniversary

The Pledge of Allegiance was written for the 400th anniversary, in 1892, of the discovery of America. A national committee of educators and civic leaders planned a public-school celebration of Columbus Day to center around the flag. Included with the script for ceremonies that would culminate in raising of the flag was the pledge. Therefore, it was in October 1892 Columbus Day programs that school children across the country first recited the Pledge of Allegiance this way:

First Version of the Pledge

I pledge allegiance to my Flag and to the Republic for which it stands: one Nation indivisible, with Liberty and Justice for all.



The Author

Controversy continues over whether the author was the chairman of the committee, Francis Bellamy - who worked on a magazine for young people that published the pledge - or James Upham, who worked for the publishing firm that produced the magazine. The pledge was published **anonymously** in the magazine and was not copyrighted.

According to some accounts of Bellamy as author, he decided to write a pledge of allegiance, rather than a salute, because it was a stronger expression of loyalty - something particularly significant even 27 years after the Civil War ended. "One Nation indivisible" referred to the outcome of the Civil War, and "Liberty and justice for all" expressed the ideals of the Declaration of Independence.

In 1923, “the flag of the United States” replaced the words “my flag.” This change occurred because some feared that foreign-born people might have in mind the flag of the country of their birth, instead of the U.S. flag. A year later, “of America” was added after “United States.”

No form of the pledge received official recognition by Congress until June 22, 1942, when it was formally included in the U.S. Flag Code. The official name of The Pledge of Allegiance was adopted in 1945. The last change in language came on Flag Day 1954, when Congress passed a law that added the words “under God” after “one nation.”

Originally, the pledge was said with the right hand in the so-called “**Bellamy Salute**,” with the hand resting fist outward from the chest, then the arm extending out from the body. Once Hitler came to power in Europe, some Americans were concerned that this position of the arm and hand resembled the salute rendered by the Nazi military. In 1942, Congress established the current practice of rendering the pledge with the right hand placed flat over the heart.



Federal Code

Section 7 of the Federal Flag Code states that “when not in military uniform, men should remove any headdress with their right hand and hold it at the left shoulder, thereby resting the hand over the heart.” People in military uniform should remain silent, face the flag and render the military salute.

The Flag Code specifies that any future changes to the pledge would have to be with the consent of the President. The Pledge of Allegiance now reads:

"I pledge allegiance"

.....*I promise to be true*

"to the flag"

.....*to the symbol of our country*

"of the United States of America"

.....*each state that has joined to make our country*

"and to the Republic"

.....*a republic is a country where the people choose others to make laws for them. The government is for the people*

"for which it stands,"

.....*the flag means the country*

"one Nation"

.....*a single country*

"under God,"

.....*the people believe in a supreme being*

"indivisible,"

.....*the country cannot be split into parts*

"with liberty and justice"

.....*with freedom and fairness*

"for all."

.....*for each person in the country ...you and me!*

Conclusion

The United States is one of the few nations in the world to have pledge to its flag. Many individuals argue that the Pledge of Allegiance to our flag has usurped the U.S.

U.S. MARINE CORPS. JROTC
Category 5 – General Military Subjects
Skill 4 – Customs, Courtesies, and Traditions

Constitution and the Bill of Rights as the cornerstone of American patriotism. This argument has been going on for a long time and will continue to be argued for years to come. Each American must decide for themselves the importance of the Pledge of Allegiance and how it reflects on their patriotism. ❖

Marine Corps JROTC Rank Structure

PURPOSE

This lesson introduces you to the MCJROTC Rank Structure. It provides information on cadet officer and cadet enlisted rank and insignia.

Introduction

One of the most distinguishing features about the MCJROTC is that cadets have to wear uniforms at least once a week. Even more distinguishing is the **rank structure** within the Cadet Corps, which further distinguishes cadets in uniform. **Rank** and **insignia** identify cadets as cadet **officers** and cadet **enlisted**.

Background

This MCJROTC ranks structure was modeled after the Marine Corps ranks structure. The uniforms issued and worn by cadets are the same as those worn on active duty by Marines. Therefore, the design of the MCJROTC rank insignia distinguishes cadets from Marines.

In order to better understand rank structure, you must understand the meaning of rank insignia and Lamp of Learning. The following definitions will provide insight about each.

Rank

Rank as it applies to this lesson is the designation of an official position such as Sergeant, or Captain.

Insignia

Insignia is an emblem, badge, medal, or other distinguishing mark of office, honor, position, or mission.

Lamp of Learning

The Lamp of Learning device used in the cadet enlisted rank insignia signifies intensive study, a source of intellect, and moral and spiritual illumination.



MCJROTC Rank Structure

The MCJROTC Cadet Corp comprises cadet officer and cadet enlisted personnel. Although modeled after the Marine Corps rank structure, the MCJROTC officer and enlisted insignia is specific to the MCJROTC program.

Cadet Officer Rank Structure

The cadet officers in the MCJROTC in order of seniority, from highest to lowest, are as follows:

Cadet Rank

- Cadet Colonel
- Cadet Lieutenant Colonel
- Cadet Major
- Cadet Captain

- Cadet First Lieutenant
- Cadet Second Lieutenant

The cadet officer insignia as shown in the subsequent chart is authorized for MCJROTC cadet officers and will be furnished at government expense.

Cadet Enlisted Rank Structure

The cadet enlisted members in the MCJROTC in order of seniority from highest to lowest are as follows:

Cadet Rank

- Cadet Sergeant Major
- Cadet Master Sergeant

- Cadet Gunnery Sergeant
- Cadet Staff Sergeant
- Cadet Sergeant
- Cadet Corporal
- Cadet Lance Corporal
- Cadet Private First Class
- Cadet Private

The cadet enlisted insignia as shown in the chart is authorized for MCJROTC cadets and will be furnished at government expense.

INSIGNIA OF GRADE FOR CADET OFFICERS

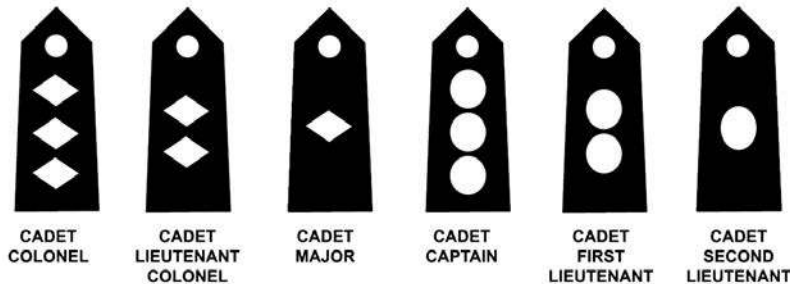

INSIGNIA OF GRADE FOR CADET ENLISTED PERSONNEL

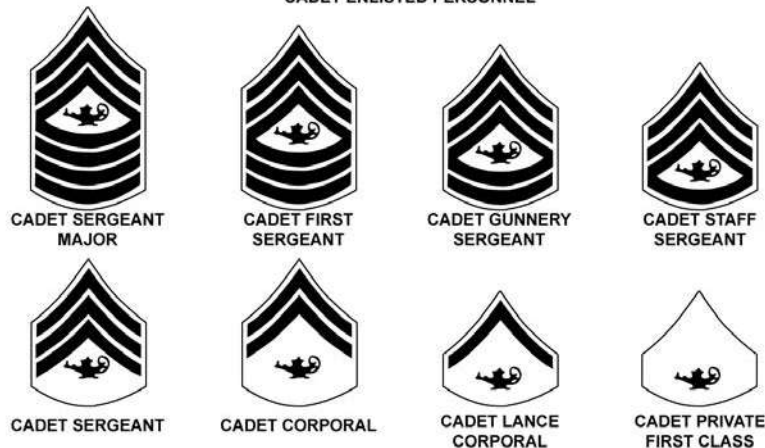

Conclusion

Remember, wearing the uniform once a week readily identifies you as a member of the MCJROTC. Internally within the Cadet Corps, the rank insignia that you wear readily identifies your status in the program.

Initially, you will start out at the bottom of the rank structure. It is up to you to determine how far you will go. To be successful in MCJROTC, you must be able to identify the officer and enlisted rank structure within your program. After all, you may be the battalion commander one day.❖

Marine Corps Rank Structure

PURPOSE

This lesson introduces you to the Marine Corps Rank Structure. It provides information on officer and enlisted rank, grades and insignia.



Introduction

As a member of the MCJROTC, it is important that you know and understand the Marine Corps rank structure. As previously stated, the rank structure for MCJROTC program is modeled after the Marine Corps rank structure.

Background

On November 10, 1775, the Continental Congress passed a resolution stating, “two battalions of Marines be raised” for service as

landing forces with the fleet. This resolution, sponsored by John Adams, established the Continental Marines and marked the official birthday of the Marine Corps. Serving on land and at sea, these first Marines distinguished themselves in a number of operations, including their first amphibious raid in New Providence, Bahamas, on March 3, 1776.

Rank and grade are part of the Marine Corps personnel classification system. It provides a means for identifying manpower for the Marine Corps and Congress. Just like the school system has the grades, numbers, and names of students within the school, the Marine Corps has the rank, grade, and names of all available Marines. This information is used for personnel planning, recruitment, selection for training, development of training needs, promotions, and assignments. It may also be used for the orderly call to active duty or inactive duty personnel in times of national emergency or mobilization.

History

Today’s Marine Corps rank insignia are the result of thousands of years of traditions. The Marine Corps rank structure and insignia date back as far as 1798. From that point on, it has evolved to what it is today.

In the earliest days, rank was not an issue. As military organizations started growing, people didn’t know who was in charge. The badge of rank became an important method of identification.

Through the ages, the rank has included such symbols as feathers, sashes, stripes, and showy uniforms. Even carrying different weapons

have signified rank. The badges of rank have been worn on hats, shoulders, and around the waist and chest.

In 1780, regulations prescribed two stars for major generals and one star for brigadier generals. The rank structure and insignia continued to evolve. Colonels were authorized the insignia of the eagle in 1832. From 1836 on, the silver and gold oak leaves denoted lieutenant colonels and majors; double silver bars denoted captains; and single silver bars denoted first lieutenants. Second lieutenants were authorized their insignia, a single gold bar, by Congress in 1917.

Chevrons (enlisted insignia) are V-shaped stripes whose use in the military go back to at least the twelfth century. It was a badge of honor and used in heraldry. The British and French used chevrons (the French word for “roof”) to signify length of service.

Chevrons officially denoted rank in the U.S. Military for the first time in 1817, when cadets at the U.S. Military Academy at West Point, N.Y., wore them on their sleeves. From West Point, chevrons spread to the Marine Corps and the Army. The difference then was chevrons were worn points down until 1902 when Marine Corps and Army enlisted personnel switched to the present configuration.

Congress created the Marine Corps grade of sergeant major in 1798. Sergeant Major Archibald Summers was the first incumbent of that position.

Marine Corps Rank Structure

One of the most distinguishing features about the Marine Corps is the uniform. Even more distinguishing is the rank structure within the Marine Corps because it further defines who

an individual is. Rank, grade, and insignia identify Marines as officers and enlisted.

The Marine Corps also has warrant officers. **Warrant officers** are prior enlisted Marines with specialties in certain fields. Congress established the warrant officer program on August 29, 1916, just prior to World War 1. Since 1916, the Marine Warrant Officer Program has undergone many changes to evolve to its current status.

Warrant officers hold a “warrant” that is an official certificate of appointment issued to an officer of lower rank than a commissioned officer. A commissioned officer holds a rank of second lieutenant or above. A commission is the formal written warrant granting the power and authority to perform various acts or duties.

The Marine Corps warrant officer is a technical officer specialist who performs duties that require extensive knowledge, training, and experience with particular systems or equipment. Their duties and responsibilities are of a nature beyond those required of senior noncommissioned officers. Marine Corps warrant officers provide experience and stability in the officer ranks in critical specialty areas.

Officer Rank Structure

Officers in the United States Marine Corps in order of seniority from highest to lowest are as follows:

<u>Rank</u>	<u>Grade</u>
• General	0-10
• Lieutenant General	0-9
• Major General	0-8
• Brigadier General	0-7

U.S. MARINE CORPS. JROTC
Category 5 – General Military Subjects
Skill 5 – Rank Structure

• Colonel	0-6	• Staff Sergeant	E-6
• Lieutenant Colonel	0-5	• Sergeant	E-5
• Major	0-4	• Corporal	E-4
• Captain	0-3	• Lance Corporal	E-3
• First Lieutenant	0-2	• Private First Class	E-2
• Second Lieutenant	0-1	• Private	E-1

The officer insignia is shown in the subsequent chart.

Warrant Officer Rank Structure

The Marine Corps Warrant Officer rank structure is as follows in order of seniority from highest to lowest:

<u>Rank</u>	<u>Grade</u>
• Chief Warrant Officer, CW05	W-5
• Chief Warrant Officer, CW04	W-4
• Chief Warrant Officer, CW03	W-3
• Chief Warrant Officer, CW02	W-2
• Warrant Officer, W01	W-1



























As you can see, both Sergeant Major and Master Gunnery Sergeant are identified at the grade of E-9 and First Sergeant and Master Sergeant are shown at the grade of E-8. The Sergeant Major is the senior of the two ranks at E-9 and the First Sergeant is the senior of the two ranks at the E-8 position. Master Gunnery Sergeant and Master Sergeant are ranks for technical fields. The Sergeant Major and First Sergeant are command billets and are the senior enlisted tactical advisors to the commanding officer and handle all troop related issues. The enlisted insignia is shown in the subsequent chart:

Enlisted Rank Structure

The Marine Corps enlisted rank structure is as follows in order of seniority from highest to lowest:

<u>Rank</u>	<u>Grade</u>
• Sergeant Major of the Marine Corps	E-9
• Sergeant Major	E-9
• Master Gunnery Sergeant	E-9
• First Sergeant	E-8
• Master Sergeant	E-8
• Gunnery Sergeant	E-7

U.S. MARINE CORPS. JROTC
 Category 5 – General Military Subjects
 Skill 5 – Rank Structure

CATEGORY	Rank Insignia of the United States Marine Corps					
	E-1	E-2	E-3	E-4	E-5	E-6
ENLISTED		 Private First Class	 Lance Corporal	 Corporal	 Sergeant	 Staff Sergeant
	E-7	E-8		E-9		
	 Gunnery Sergeant	 Master Sergeant	 First Sergeant	 Master Gunnery Sergeant	 Sergeant Major	 Sergeant Major of the Marine Corps
	W-1	W-2	W-3	W-4	W-5	
WARRANT OFFICER	 Warrant Officer	 Chief Warrant Officer 2	 Chief Warrant Officer 3	 Chief Warrant Officer 4	 Chief Warrant Officer 5	
	O-1	O-2	O-3	O-4	O-5	O-6
COMPANY AND FIELD GRADE OFFICER	 (gold) 2nd Lieutenant	 (silver) 1st Lieutenant	 (silver) Captain	 (gold) Major	 (silver) Lieutenant Colonel	 (silver) Colonel
	O-7	O-8	O-9	O-10		
GENERAL OFFICER	 Brigadier General	 Major General	 Lieutenant General	 General		

Conclusion

It is very important that you become familiar with and understand the Marine Corps rank structure. After all, it is the structure from which your program is modeled. Remember the added benefits if you decide to enlist in the Marines. You will already be ahead of your peers because you know the Marine Corps rank structure.❖

The Purpose of the Chain of Command

PURPOSE

This lesson introduces you to the concept of the chain of command. It defines chain of command, and identifies and describes the two purposes of the chain of command.

Introduction

Whenever two or more people combine their efforts to do a job, an organization exists. The military, the Marine Corps, and MCJROTC are no different. In the Marine Corps, thousands of people combine their efforts to carry out a large mission. This huge organization is able to do its job because it has been organized for that purpose. A line of responsibility and authority extends from top to bottom, and relationships between and within sections are spelled out. All military organizations work within a structure known as the **chain of command**.



Chain of Command Defined

The chain of command is the system used to ensure that each individual receives instructions for a particular task from only one supervisor. It is an authority and accountability chain from the highest office or position within the chain to the lowest element. The chain of command assists commanders at all levels to achieve their primary function of accomplishing the organization or unit's assigned mission while caring for personnel and property in their charge.

A chain of command provides proper avenues of communication. It allows for members to give and receive information. When used properly, it is both simple and effective.

The chain of command varies based on the command involved. All orders and instructions should be issued through the chain of command. A person or unit can only have one immediate commander who issues orders and provides instructions. Using the chain of command, an individual commander may limit the number of personnel who are directly supervised.

Purposes of the Chain of Command

The chain of command serves two purposes. The two purposes are to:

- **Decentralize authority**
- Link the different levels of command

Decentralize Authority

Since it is impossible for one person to assign duties to every individual or to supervise every task personally, assignments are passed down through the levels of command. This is called decentralization of authority. For example, the dining facility officer tells the chief cook what foods to prepare for a meal. The chief cook then tells the section cook, who in turn tells the other cooks. When assigning duties to an individual junior in rank, that individual has the authority to accomplish those duties. However, the overall responsibility for its success remains with the Marine originating the order.

Link Levels of Command

Besides the decentralization of authority, another purpose of the chain of command is to link the different levels of command. This way, the infantry private can talk to his battalion commander if necessary. The private goes through his fire team leader with a problem. If the problem cannot be solved by his fire team leader, he is sent to the squad leader, then to the platoon sergeant, next to his platoon commander, and finally to his company commander. If the problem cannot be solved by any of these Marines after they are seen in order of their authority, the private is sent to the battalion commander. Any Marine can go as high as necessary to get a problem resolved. All that the Marine must do is to follow the chain of command one step at a time. This is the same process that is used in the MCJROTC chain of command. Go through each level of command in your chain of command one step at a time until the problem is resolved or the question is answered.

Conclusion

As a MCJROTC cadet, it is important that you understand the chain of command and how it works. In upcoming lessons, you will be provided the chain of command for the Marine Corps as well as the MCJROTC. Proper use of the chain of command is vital to the overall effectiveness of the Marine Corps as well as the MCJROTC.❖



MCJROTC Unit Chain of Command

PURPOSE

This lesson identifies the MCJROTC unit chain of command and organization. It explains the MCJROTC unit chain of command and identifies positions within the chain of command and the MCJROTC unit organization.

Introduction

Just as the chain of command is important in order to have organization and clear communications in military organizations, it is just as important to have a chain of command and a defined **unit** organization in MCJROTC. The MCJROTC organization and structure follows that of the Marine Corps. As such, there is an established cadet chain of command within the MCJROTC Cadet Corps.

Purpose of the MCJROTC Unit Chain of Command

The reason for the MCJROTC unit chain of command is the same as that for any military organization. It is the system used to ensure each individual receives instructions for a particular task from only one supervisor. It is an authority and accountability chain from the highest office or position within the chain, to the lowest element. Remember, military command is exercised through a series of leaders. When a commander wants a specific task accomplished, a subordinate is given an order and that order is passed down the chain of command. This saves the

commander much time and trouble. For instance, the commander will give the order to the lieutenants who are the platoon leaders. They will then give it to the sergeants who are the squad leaders. The squad leaders will give the order to their squad members. In this way, the information flows from commanders to subordinates. The series of leaders along which the command follows is called the chain of command. The MCJROTC cadet chain of command from highest to lowest is as follows:

- Board of Education
- Superintendent
- Principal of School
- Senior Marine Instructor
- Cadet **Battalion Commander**
- Cadet **Company Commander**
- Cadet **Platoon Leader**
- Cadet **Squad Leader**
- Cadet

This MCJROTC chain of command is linked at the Senior Marine Instructor level to the Marine Corps as well as the school. The Senior Marine Instructor answers to both chains of command. Details on the Marine Corps Chain of Command will be provided in a separate lesson.

Organization of the MCJROTC Cadet Corps

There are two types of military organizations that may be used at the discretion of the Senior Marine Instructor. The two types of military organizations are **battalion** level and

company level. The strength of the MCJROTC unit will determine the organizational structure.

Battalion Level

The battalion level organization is recommended for units with more than 150 cadets. The battalion may be divided into three companies. A battalion commander commands the battalion level organization.

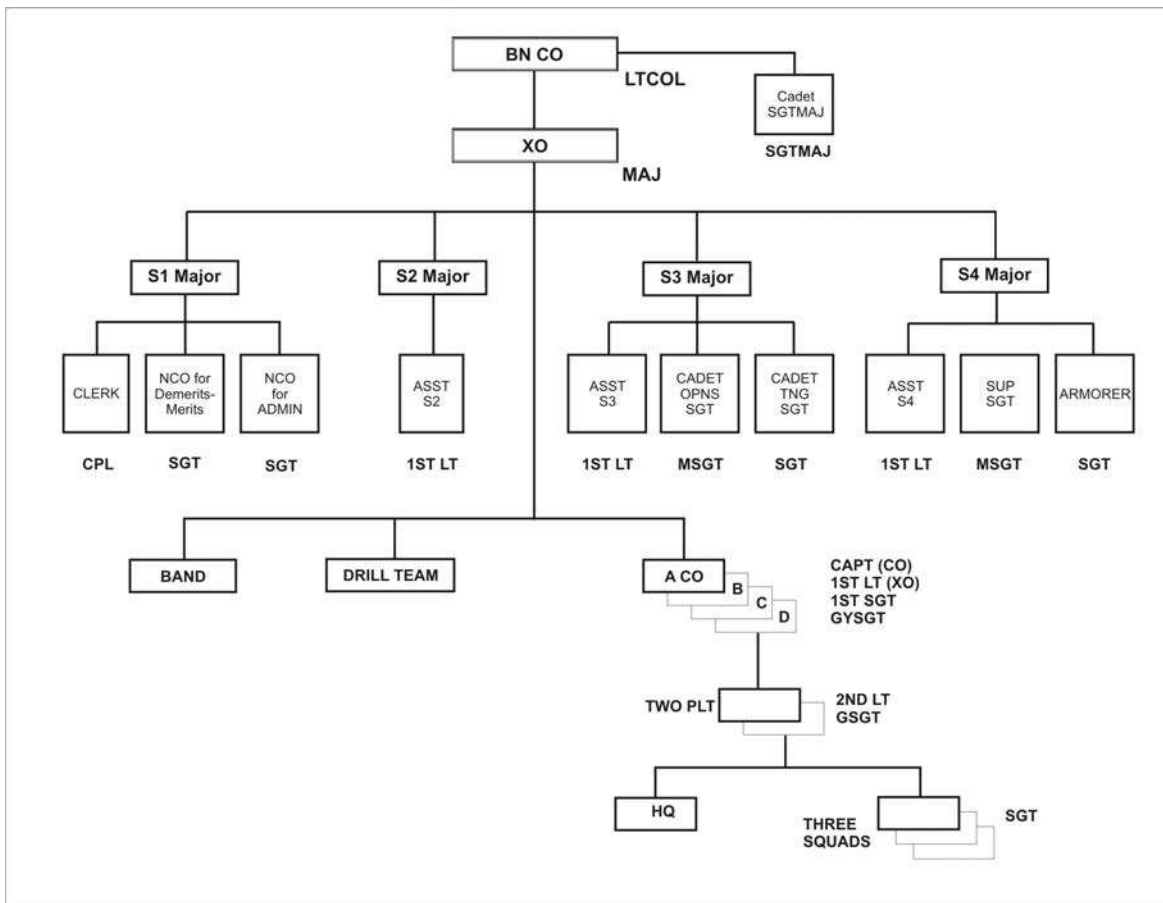

Company Level

A company level organization may be established for an organizational strength of less than 150 cadets. When an MCJROTC unit is established as a company, the company is divided into three platoons and a headquarters section. The company headquarters contains the following key personnel:

- Company Commander
- Company Executive Officer
- Company First Sergeant
- Guidon Bearer

Each platoon is composed of a headquarters section and at least two to three squads, with a minimum of two fire teams per squad. The key platoon personnel are as follows:

- Platoon Leader
- Gunnery Sergeant
- Two or three Squad Leaders
- Two or three Fire Team Leaders

Conclusion

The cadet organization is set up to ensure a quick and clear flow of commands. Each individual cadet has a job to do, which is part of a squad task, and so forth up the chain of command until that individual task is part of the battalion or company's overall mission.

Just like the Marine Corps, the MCJROTC is organized to ensure that it is an efficient and effective organization. Having an established MCJROTC chain of command and unit organization are the key. Proper use of the chain of command is vital to the overall effectiveness of your organization.❖

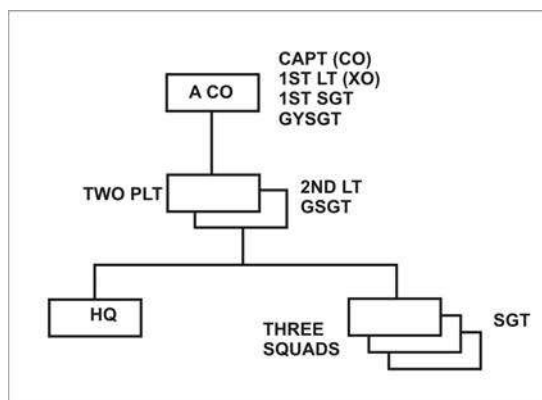

Marine Corps Chain of Command

PURPOSE

This lesson explains the purpose of the Marine Corps chain of command. It also identifies the Marine Corps chain of command from the President of the United States to the Senior Marine Instructor.

Introduction

As a cadet in the MCJROTC, knowing the chain of command and knowing how to use the chain of command is an important factor in becoming a successful leader. You have previously learned what a chain of command is and your unit chain of command. Now, you will learn about the Marine Corps chain of command as a whole within the government of the United States.

The Marine Corps has an established chain of command. As you have seen, the Senior Marine Instructor is the link between the school and the Marine Corps. He answers to both the Marine Corps and the school. And, as a member of the MCJROTC, you too, fall under both chains of command.

Purpose of the Marine Corps Chain of Command

The purpose of the Marine Corps chain of command is to ensure organization and an effective communication channel. The Marine Corps chain of command is essential to accomplishing the objective or goal of military

leadership which is “the creation and maintenance of an organization that will loyally and willingly accomplish any reasonable task, assigned or indicated, and will initiate suitable action in the absence of orders.”

The Marine Corps Chain of Command

The Marine Corps chain of command starts from the President of the United States. His title/position in the chain of command is the **Commander in Chief**. He is at the top of the chain of command for the Department of Defense, which includes the United States Marine Corps. The Marine Corps chain of command is as follows:

- The President
- **The Secretary of Defense**
- **The Secretary of the Navy**
- **Commandant of the Marine Corps**
- **Commanding General, Marine Corps Combat Development Command**
- **Commanding General, Training and Education Command**
- **Director, Marine Corps Junior ROTC Program**
- Senior Marine Instructor

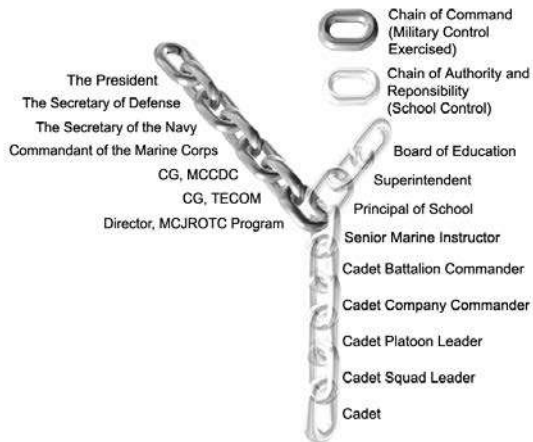

The top three positions in the chain of command are not military, therefore they cannot be addressed with military rank. The President is announced as the “President of the United States” and addressed as “Mr. President.” The same applies to the Vice President. Other dignitaries of lesser station are addressed and announced as “Honorable.” The term Honorable is used with the full name of the person holding the position when addressing the Secretary of Defense and the Secretary of the Navy. Honorable is used as a sign of respect for the positions that these individuals hold.

The President

Commander in Chief is the title of the officer in supreme command of the military forces of a country. The President of the United States is the Commander in Chief of the Armed Forces and holds the highest position in the military chain of command. As such, that position is also the highest in the chain of command for the United States Marine Corps. The U.S. Constitution is the

authority under which the title of Commander in Chief is attached to the office of the president.

Secretary of Defense

The Secretary of Defense is the principal defense policy adviser to the President. The Secretary is responsible for providing general defense policy and policy related to all matters of direct concern to the Department of Defense. The Secretary also exercises authority, direction and control over the Department of Defense that includes military and civilian personnel.

Secretary of the Navy

Under Title 10 of the United States Code, the Secretary of the Navy is responsible for, and has the authority to conduct, all the affairs of the Department of the Navy. This includes: recruiting, organizing, supplying, equipping, training, mobilizing, and demobilizing. The Secretary also oversees the construction, outfitting, and repair of naval ships, equipment and facilities. Responsibilities include forming and implementing policies and programs consistent with national security policies and objectives established by the President and the Secretary of Defense. The Department of the Navy consists of two uniformed Services: the United States Marine Corps and the United States Navy.

Commandant of the Marine Corps

The Commandant of the Marine Corps is the commander of the United States Marine Corps. This is the highest position held by a person in uniform in the Marine Corps.

Commanding General, Marine Corps Combat Development Command

The Commander is responsible to the Commandant for all processes of training, education, development, structure and support to assure the Marine Corps is prepared to carry out its mission.

Commanding General, Training and Education Command

The Commander is responsible for all training and education for the Marine Corps. The MCJROTC is an education program and therefore falls in this chain of command.

Director, Marine Corps Junior ROTC Program

The Director is responsible to the Commanding General of the Training and Education Command for program operation and growth, while carrying out the mission of the Marine Corps JROTC Program.

Marine Corps Junior ROTC Project Officer

The Project Officer represents an area Marine Corps District, but serves the program director by conducting inspections of MCJROTC units to assure compliance with program policies.

Senior Marine Instructor

The Senior Marine Instructor works for the high school principal to carry out the MCJROTC program policies the school has agreed to comply with.

Conclusion

The Marine Corps chain of command is a vital link to the successful operation of the MCJROTC program. After all, if there were no Marine Corps, there would not be a Marine Corps JROTC. Knowing and understanding these key positions and the people holding these positions in your military chain of command can help you climb the ladder to success and enhance your awareness as a citizen.❖

From the Halls of Montezuma The Marine Corps (1775-1848)

PURPOSE

The rich and varied history of the Marine Corps precedes the establishment of the United States. Like the British Royal Marines after whom they were modeled, Colonial Marines served with the British in 1740 in England's war against Spain. Led by Colonel William Gooch, these battalions included approximately 3,000 men and were known as Gooch's Marines. During the French and Indian War, colonials again served as Marines fighting with the British. The development of the Marine Corps mirrors the establishment and growth of the United States. No story of the emergence of the United States as the dominant nation of the Western Hemisphere can be told without telling the story of the United States Marine Corps.



Marines in the American Revolution

Under his leadership, the Marines took Fort Montagu from the British in the Bahamas. The Marines were able to capture gunpowder, cannon, smaller guns, and mortars. They also were able to free three American ships captured by the British. The first objective of the Marines was considered a success.

Marines fought throughout the American Revolution on ships at sea. They fought with John Paul Jones aboard the *Ranger*. They boarded enemy vessels, assaulted the British with musket fire when they could not board, and provided the Navy with a landing force. Like the Marines of today, these Marines showed courage in battle, did their duty, and conducted themselves with honor.

After the Revolution, there was a fear that a professional army might make it difficult for the United States to remain a democracy. However, it soon became clear that without an army, the U.S. would be at the mercy of other nations. In 1794,

Introduction

On November 10, 1775, the birthday of the Marines, the Continental Congress passed a resolution that established two battalions of Marines. This resolution, signed by John Hancock, later to become famous as the first signer of the Declaration of Independence, instituted the American Marines. Within three weeks, **Samuel Nicholas** was commissioned as the first officer of the Marines and its first **commandant**.

Congress authorized the enlistment of sailors and Marines. In 1798, Congress enacted legislation that established the Marine Corps. **William Ward Burrows** was given the title of Lieutenant Colonel Commandant. Burrows improved the discipline of the Corps by emphasizing drill for both officers and enlisted men. He also created the Marine Corps Band that often performed for the President.

Peg Mullen's Beef-Steak House—better known as Tun's Tavern—was the site of Naval Committee meetings. The Naval Committee was created to oversee the development and employment of American sea power. Tun Tavern became an important recruiting center for the Marines, and it is reputed that Robert Mullen's success as a recruiter led to his being made a captain in the Marines.



The Barbary Wars

The four Barbary States of North Africa – Morocco, Algiers, Tunis, and Tripoli – had plundered sea borne commerce for centuries. Surviving by blackmail, they received great sums of money, ships, and arms yearly from foreign powers in return for allowing the foreigners to trade in African ports and sail unmolested through the Barbary waters. They demanded tribute money, seized ships, and held crews for ransom or sold them into slavery.

Barbary pirates seized American merchant ships, no longer covered by British protection, in the years after United States' independence, and American crews were enslaved. In 1799, the United States agreed to pay \$18,000 a year in return for a promise that Tripoli-based corsairs would not molest American ships. Similar agreements were made at the time with the rulers of Morocco, Algiers, and Tunis.

In May 1801, the United States refused to succumb to the increasing demands of the Pasha (ruler) of Tripoli; in return, the Pasha declared war against the States. While Tripoli was not a strong power and little effort was necessary to watch and blockade it, the fear was that the other Barbary powers would join against the United States. The United States sent naval squadrons into the Mediterranean under the slogan of "Millions for defense, but not one cent for tribute!" Under the leadership of Commodores Richard Dale and Edward Preble, the Navy blockaded the enemy coast, bombarded the Pasha's shore fortresses, and engaged in close, bitterly contested gunboat actions.

On February 16, 1804, Lieutenant Stephen Decatur led 74 volunteers, including eight Marines, into Tripoli harbor to burn the captured American frigate, the *Philadelphia*. The pirates had captured the ship when it struck a rock in Tripoli

harbor and was disabled. The U.S. feared that the pirates would be able to repair the *Philadelphia* and use it against American ships. British Admiral Lord Nelson called the raid "the most daring act of the age."

In 1805, Marines stormed the Barbary pirates' harbor fortress stronghold of Derna (Tripoli), commemorated in the Marine Corps Hymn invocation "To the Shores of Tripoli." Former consul William Eaton devised a plan to overthrow the Pasha of Tripoli and replace him with the Pasha's brother, Hamet, who was more favorably disposed toward the U.S. First Lieutenant **Presley Neville O'Bannon** is remembered for heroism in the battle for Derna. O'Bannon's Marines were the first U.S. forces to hoist the flag over territory in the Old World. Hamet presented the jewel encrusted "Mameluke" sword, carried by Marines officers today, to O'Bannon in 1805. Oddly enough, the Pasha came to an agreement with the State Department and continued in power. The European powers ended the control of the Mediterranean by Barbary pirates a decade later.

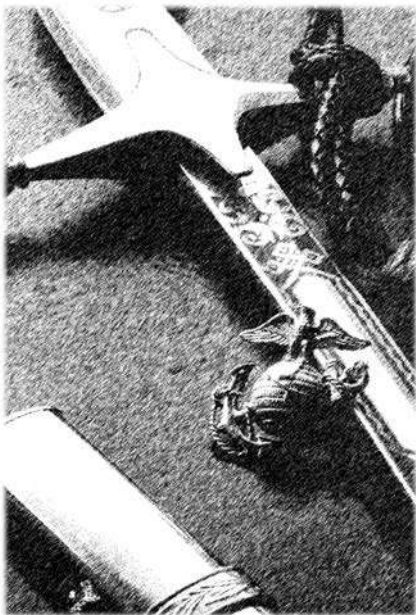

The War of 1812

When George Washington left office after the completion of his second term in 1796, he warned Americans to stay clear of foreign entanglements. While this advice may have been good for the country at the time, it left the United States unprepared for a British invasion in the War of 1812.

The United States declared War on Great Britain on June 12, 1812 because of long simmering disputes with Great Britain. The central dispute surrounded the **impressments** of American soldiers by the British. The British had previously attacked the USS *Chesapeake* and nearly caused a war two years earlier. In addition, disputes continued with Great Britain over the Northwest Territories and the border with Canada. Finally, the attempt of Great Britain to impose a blockade on France during the Napoleonic Wars was a constant source of conflict with the United States.

Marines, serving under Commodore Oliver Hazard Perry on Lake Erie, used their excellent marksmanship to decimate the English seamen on the decks of their ships. When able to get close enough, the Marines boarded British ships and usually defeated the enemy. Several successful sea battles included victories by the *Constitution* commanded by Lieutenant Bush and by the *Chesapeake* commanded by Captain James Lawrence. It was Lawrence who, as he was dying, uttered the famous words, "Don't give up the ship."

On land, the Marines under the command of Captain **Samuel Miller**, fought at the Battle of Bladensburg just outside of Washington, DC. Even though they were badly outnumbered, the combination of seamen and marines withstood three British charges. Finally, they were forced to withdraw, and the British went on to burn the city.

It is said, however, that the Marine headquarters was spared because of the bravery shown by the Marines at Bladensburg.

In 1815 at New Orleans, the Marines were under the command of Major Daniel Carmack. Even though Carmack was wounded and unable to participate, his men so well defended the fortifications that Congress cited them for “valor and good conduct.” The irony of the Battle of New Orleans was that the victory came after a peace treaty with the British had been signed the month before.

Growth of the Corps

In the period between 1815 and 1836, the United States did not engage in any foreign wars. Lieutenant Colonel **Franklin Wharton**, commandant from 1804 to 1818, focused on improving the disciplinary system, and improving health and living conditions in marine quarters. He established Marine Corps barracks where drilling and training could take place. He was responsible for adopting the hand salute.



Major **Archibald Henderson**, who came to be known as the “Grand Old Man of the Corps,” served as commandant from 1820 to

1859. Henderson was able to preserve the Corps during peacetime when there was a danger that it could be dissolved or taken over by the Army or the Navy. Henderson was able to wrest control over the assignment of officers, get more officers and men for the Corps, get better accommodations, and get better training facilities.

When President Jackson called for troops to fight the Seminole Indians in the southeast, Henderson volunteered the Marine Corps and led the Marines in the field. In fact, the story goes that Henderson nailed a note on his door that stated, “Gone to Florida to fight Indians, will return when the war is over.” While the Marines had limited success against the Seminoles in Florida, they engaged the Creek Indians in numerous battles in Georgia and Alabama. The Indian Wars provided the Marines with their first opportunity to engage the enemy as an **expeditionary force** when they were forced to march extraordinary distances to engage the enemy. The war against the Indians of the southeast ended in 1842.

The nickname “Leatherneck” goes back to the leather stock or neckpiece that was part of the Marine uniform between 1175 and 1875. While one story says that its purpose was to protect the neck from sword slashes, the most likely story is that it was intended to ensure that Marines kept their heads erect.

The Mexican War

Since 1836, Texas had declared itself independent from Mexico. Until 1846, there was a dispute over that independence when finally the United States **annexed** Texas. Texas had set the Rio Grande as its border to the south and west. That boundary now became the basis for a dispute

between the United States and Mexico. President James K. Polk sent John Slidell to Mexico to negotiate a settlement, but the Mexican government refused to see him and eventually had him sent out of the country.

The massing of Mexican troops on the southern bank of the Rio Grande led President Polk to order General Zachary Taylor to move to the borders. Taylor marched to the Rio Grande and fortified a position on the northern bank. The Mexican and the American troops were thus facing each other across the river. When Taylor refused to retreat to the Nueces River, the Mexican commander crossed the Rio Grande, ambushed a scouting force of 63 Americans, and killed or wounded 16 of them (April 24, 1846).

President Polk addressed Congress asking for and receiving a declaration of war against Mexico. He cited the Mexican government's refusal to negotiate and their attack on Americans on American soil as reasons for his request. Congress agreed and voted for 50,000 men and \$10 million to be allocated to prosecute the war.

President Polk believed in **Manifest Destiny**, that it was the God-given right or destiny, to expand the country's borders from coast to coast. In 1846, present day California and New Mexico were considered part of Mexico. Polk assigned First Lieutenant **Archibald Gillespie** to carry dispatches to the American Consulate in California and to Captain John C. Fremont. Gillespie was also expected to travel through Mexico to see if a war was imminent. Gillespie discovered that the Mexicans were unhappy with their government, but were not too fond of Americans either. At the time that Gillespie delivered his messages, the war began. He fought in several battles in California under a number of military commanders. He exemplifies the "can do" attitude of the Marine Corps.

Officers and noncommissioned officers have worn scarlet stripes on their dress trousers ever since the early days of the Corps. The Marine lore says that the right to wear the scarlet stripes was conferred on the Corps after the battle of Chapultepec, in honor of Marine officers and noncommissioned officers who were killed or wounded during the action.

The Marines were involved in the largest amphibious landing for the American military before World War II at Vera Cruz. A provisional battalion of 200 Marines joined with the armies of General Taylor and General Winfield Scott to defeat the Mexicans in a number of battles in 1847.

As Scott's army began to dwindle in size, Commandant Henderson volunteered six companies of Marines who marched 200 miles through Mexico to join Scott's force in August of 1847.

The decisive battle of the Mexican War is the attack on Chapultepec, a castle that protected the road to Mexico City. On September 13, the Americans bombarded the castle for two hours. Then under Brigadier General John A. Quitman, whose forces included the newly arrived Marines, the Americans assaulted the hill upon which rested Chapultepec. The fighting lasted all day, but in the end, U.S. forces captured the castle and the gates to the city. By the next morning, U.S. forces raised the American flag in the Mexican capital. The Marines had been to the Halls of Montezuma.

Conclusion

Shortly after the Treaty of Guadalupe-Hidalgo was signed ending the war, gold was discovered in California. By the end of the Mexican War, the United States had established itself as the most powerful country in the Western Hemisphere, with borders from the Atlantic to the Pacific Oceans. Marines had distinguished themselves in battles against the Barbary Pirates, the British, and the Mexicans. ❖

Growth in Size and Stature (1859-1918)

PURPOSE

The United States Marine Corps grew in size and importance during the period between the Civil War and the end of World War I. The reputation of the Marines was enhanced, as they became the Advanced Base Force for American troops. With each new involvement, the Marines became known as the elite fighting force of the United States.

Introduction

During the period of time between 1859 to 1918, the United States Marine Corps became involved in civil wars both in the United States and abroad, as well as in the Spanish-American War and World War I. These events would be a test to see if the Marine Corps could eventually become the elite fighting machine that would lead America into battle when it was time to defend its own vital interests.

Harper's Ferry and the Civil War

In October 1859, John Brown, an abolitionist who believed that using violence to free the slaves was justified, attempted to seize a munitions depot at Harper's Ferry in what is now known as West Virginia. Lieutenant Israel Greene led 86 Marines into the engine house where Brown had fortified himself. Greene captured Brown. Ironically, J. E. B. Stuart and Robert E. Lee were army officers at Harper's Ferry with

Colonel Lee in charge of the mission. Both became famous as Confederate officers.

When Southern states left the Union, many of the outstanding Marine officers joined the Confederacy. About half of the Marine Corps captains resigned, and nearly two-thirds of its first lieutenants left the service. As a result, the Marine Corps appointed 38 new officers in early 1861. Most of these officers had little or no previous military experience.

Marine Corps action in the Civil War was limited. One action is noteworthy. When the USS *Galena* was disabled under Confederate fire just south of Richmond, Marine Corporal John Mackie rallied the troops, restored three of the *Galena's* guns to firing condition, and carried off the dead and wounded. For his heroism, Mackie was the first Marine to be awarded the Medal of Honor.



During the years 1866-1897 there were few military engagements for the Marine Corps. However, during this time, John Phillip Sousa was hired as the Marine Corps bandmaster. He wrote a march that used “Semper Fidelis,” always faithful, as its title. It was also during this time that the Marine Corps emblem achieved its present form.

The Spanish American War

In 1898, Cuba, the Philippines, and Puerto Rico were under the control of Spain. Like many nations before them, elements of the population wanted independence from colonial rule. The civil disorder in Cuba particularly, only 90 miles away, concerned many Americans. Some felt that U.S. citizens and businesses were in danger; some felt that the people of Cuba were being badly treated by the Spanish; and some thought that based on the **Monroe Doctrine**, the United States should not allow European interference in the Western Hemisphere. Many Americans felt that the United States should do something. In February, the battleship *Maine* exploded in Havana harbor. It was suggested that the Spanish were responsible for the loss of 160 crewmembers including 28 Marines. Led by the newspapers of the time on both sides of the Atlantic, there was a loud cry for the United States and Spain to enter into war. The United States recognized the independence of Cuba on April 19. In spite of negotiations to prevent hostilities, the U.S. and Spain declared war on each other by the end of April of 1898. The Spanish-American War marked the end of one nation as a world power and the beginning of another.

On May 2, a new battalion of Marines sailed for Key West on board the *Panther* with Lieutenant Colonel Robert Huntington in command. On June 10, Huntington and his men were sent to Guantanamo Bay, Cuba where they set up camp at Fisherman’s Point. The day after their arrival they were attacked and the lives of two Marines were lost. After other attacks on the following two nights, the Marines decided to take action.

Lieutenant Colonel Huntington was determined that the Spanish could not maintain their positions if they were denied access to fresh water. A Marine force, accompanied by some Cuban rebels, was sent out on a mission to capture the well at Cuzco about six miles away.

When the Marines attacked the six companies of Spaniards defending Cuzco, the cruiser *Dolphin* began giving support fire from off shore. However, the Marines were in direct line of fire. While everyone else dove for cover, Sergeant John H. Quick took his blue polka dot bandana and improvised a signal flag. Standing with his back to the enemy, Quick signaled the *Dolphin* to stop firing. When the shelling stopped, Quick and the rest of the unit attacked the Spanish. The Marines captured the well at Cuzco and a signal station that was there. Quick received the Medal of Honor for his actions. The Marines stayed in Cuba until the end of hostilities, leaving Guantanamo on August 5, 1898. The activities at Guantanamo were the first instance of a Marine force being used for expeditionary reasons and landing in an amphibious operation.

In the Pacific, Commodore George Dewey had prepared for the occasion of war by taking the Asiatic Squadron and heading for the Philippines. When war was declared, Dewey slipped into Manila Bay and immediately began firing on the Spanish ships. By May 3, the Spanish

fleet was annihilated. Marines, under the command of Lieutenant Dion Williams, were the first to raise the U.S. flag on Spanish-held territory.

The ending of the Spanish-American War, in August of 1898, brought a major change in the way the world looked at the two participating nations. The defeat marked the end of Spain's colonial empire and the beginning of the United States as a global military power. As a result of the Spanish-American War, it became clear that the U.S. must have a two-ocean navy, thus speeding the construction of the Panama Canal.

The most significant aspects of the Marine Corps participation during this war were the speed with which the expeditionary force had been organized and dispatched, and its demonstrated effectiveness on the field of battle. The victory at Guantanamo, which was won by a Marine unit and commanded by a Marine officer, gave added strength to those who later would advise that the capture and defense of advance bases should become the primary mission of the Marine Corps.



The Boxer Rebellion

In the late nineteenth century, European powers had entered China and set up sovereign economic and political territories. In the late spring of 1900, the Chinese, who called themselves the “Righteous Fists of Harmony,” rebelled. The Europeans called them Boxers. The Boxers were patriots who tried to rid China of foreign economic, political, and religious influence.

Because of the concern for the safety of the American **legation** (the official headquarters of a diplomatic minister and staff in a foreign country) in the Chinese capital of Peking, Captain John T. Myers and a group of Marines were sent from the Philippines to China. At about this time the Boxers completely encircled the city. Things worsened as the days passed and the frequency of attacks on the foreign legations, places of business, and private residences increased. On June 24, Captain Meyer and his men took up positions on the legation walls. Along the walls, the fighting was heavy and hand-to-hand. The Marines and other foreign troops held their positions. So the Chinese began an artillery assault. The bombardment forced the evacuation of part of the wall. Meyers insisted that the section be defended. Then the Chinese built a tower from which they could fire directly onto the foreign positions.

On the night of July 2, Captain Meyers, 30 U.S. Marines, 26 British Marines, and 15 Russian sailors surprised the Chinese and destroyed the tower. Even though Meyer was wounded, the other Marines continued to defend the wall. Private Dan Daly received the Congressional Medal of Honor for defending an advanced position on the wall for an entire night with only his rifle.

During the next month, reinforcements from the international forces began to arrive. By August there were enough foreign troops in Tientsin and Peking to protect their interests. In effect, the Boxer Rebellion was over and the Marines returned to the Philippines.

The Philippines

During the Spanish-American War, Commodore Dewey returned the rebel leader, Emilio Aguinaldo to the Philippines. Aguinaldo did not agree with the United States about how the Philippines should be run and with his men began a guerilla war against the Americans. There was extensive fighting against the guerillas in the summer of 1899. When the situation stabilized, the Marines were called away to China.

The Marines in the Philippines were organized into a brigade of two regiments containing two battalions each. In September 1901, a group called the **Moros** attacked C Company, during their evening mess. Brigadier General Jacob Smith, U.S. Army, sent Major L.W.T. Waller and his battalion of 14 officers and 300 men to subdue the Moros. The Moros' resistance was broken by November's end.

Panama

The events in Panama settled around building a canal. At the time, the area proposed for the construction of a canal was controlled by Colombia. The first attempts at building a canal by the French were met with failure because of the difficulty of the task coupled with the outbreaks of malaria and yellow fever. One estimate put the death toll from disease at 20,000 between 1878 and 1888. In 1894, another French group attempted to build the canal without success. A treaty was then negotiated by Secretary of State

John Hay that would give the U.S. control of the canal for 99 years at a price of \$10 million dollars down and \$250,000 per year. The Colombians refused that offer.

The U.S. supported, some say encouraged, a civil uprising in Panama. On November 3, 1903, the revolutionaries took control of Panama City. The USS *Nashville* arrived and sent a landing party of Marines ashore at Colon. The object of the landing was a show of force, so that the men of the Colombian garrison would not interfere with the actions taking place on the Pacific side at Panama City. Next, the USS *Dixie* arrived with Major John Lejeune and a battalion of Marines. Lejeune went ashore with two companies of Marines. The Colombians boarded a ship and left. President Theodore Roosevelt officially recognized the country of Panama the next day.

Major Walter Reed and others determined that yellow fever and malaria were transmitted by the bite of mosquitoes. Major William Gorgas quickly eradicated the diseases and the building of the Canal proceeded to completion in 1914. The Panama Canal was a major factor in the growing of the U.S. economy and a cornerstone in its defense strategy for decades to come.

The actions of the U.S. in Latin America were considered by some to be too much of an imposition of its will over others. In what became known as the **Roosevelt Corollary** to the Monroe Doctrine, the U.S. claimed that it had the direct interest and obligation to impose order in the affairs of Latin American countries. Thus, the Marines were sent in to restore order in several Latin American nations.

Cuba

After the expulsion of the Spanish at the end of the Spanish-American War, Cuba was left without a government. After a period of military rule, the Cubans were permitted to form their own constitution and government with U.S. approval. A section called the **Platt Amendment** was added to the constitution that provided that the U.S. could intervene in Cuban affairs if the freedom of the populace was threatened. Cuba also had to grant U.S. naval bases on the island.

After a controversial election in 1906, a number of Marine detachments were sent to the island. Under orders from President Roosevelt, the Cuban president was forced to resign and a new provisional government was formed. The Marines were completely replaced by the Army by January of 1909. Once again the Marines had proved that they were a force that could be deployed quickly. The Marine action in Cuba resembled the Advance Base Force concept where the Marines establish the first military presence in an action.



Mexico and Haiti

Between 1914 and 1916, the Marines became engaged in battles in Mexico and Haiti. In Mexico, Colonel John Lejeune was called into

action with the Advanced Base Force. They landed at Vera Cruz in response to information that the Germans were sending weapons to General Victoriano Huerta who had taken control of the Mexican government. Huerta had alienated the US Navy when crewmembers from the *Dolphin* were arrested. Even though Huerta released the crew and apologized, Rear Admiral Henry Mayo demanded a 21-gun salute to the American flag. Huerta refused to comply with this demand. Within four days Vera Cruz was under control. By the summer, Huerta had fled the country, and the U.S. installed the Carranza government and relations were once again friendly.

In Haiti, the government was in economic and political disarray. The U.S. was concerned about the condition of American property. When the offer by the U.S. to help with resolving the economic problems was rejected, the Marines were sent in to remove the Haitian treasury for “safe-keeping.” When revolutions ousted two presidents, the U.S. sent in more Marines to quell disturbances by the “**Cacos**” as the rebels were called. Under the leadership of Colonel LWT Waller and Major Smedley Butler, the rebels were brought under control and a government acceptable to the U.S. was firmly put in place.

Major Butler and Gunnery Sergeant Dan Daly earned their second Medals of Honor in these efforts of the Marines to stabilize Haiti. Butler was faced with taking a fort perched atop a 4,000-foot wall. He led his men into the fort and with bayonets, swords, and clubs the Marines prevailed. Daly received his commendation for retrieving a machine gun, which had been lost during the crossing of a stream.

World War I

Because of alliances and secret treaties, the assassination of Archduke Ferdinand of Austria-Hungary in 1914 set in motion a series of events that resulted in a war of global proportions involving millions of people. On one side, Germany joined forces with Austria-Hungary. The English, French, Italians, and eventually the U.S. were on the other side as the primary participants in the war that was supposed to end all wars. However, nearly all of the countries of Europe became embroiled in this war, and it even extended to Japan and Turkey.

Between 1914 and 1917 there were a number of attacks by German U boats on American ships. The U.S. also discovered a telegram, called the **Zimmerman Note**, which proposed an alliance between the Germany and Mexico and offered Mexico the return of Texas, New Mexico, and Arizona. These incidents, plus the democratic nature of France and England, finally brought the US into the war in April of 1917.

The Marines saw their first action on the front on March 17, 1918. The Marines found themselves involved in **trench warfare**. As a result of a German offensive, there was a four-kilometer hole in the French lines. This gap was located in an area near Bois de Belleau (Belleau Woods). When the Germans attacked again, they found out how expert the Marines were as marksmen. After two more failed attacks, the Germans took up a defensive position and waited for the Allies to attack.

The Marines approached the woods from across a wheat field in four waves. The Germans allowed them to get very close before they opened fire. The Marines kept moving, but as they reached Bouresches, they found themselves running out of ammunition. Second Lieutenant

William Moore and Sergeant Major John Quick received the Distinguished Service Cross and the Navy Cross for their heroism by driving through German artillery fire to bring ammunition to the troops at Bouresches.

The Marines dug in and repulsed a counter-attack. Replacement troops came and went, but by June 26 the troops in the woods were completely made up of Marines. The Germans so respected the Marines that they called them “Teufelhunden” or “Devil Dogs.” The French renamed the woods, “Bois de la Brigade de Marines.”

In July 1918, Brigadier Generals Lejeune and Neville arrived in France. Neville was made commander of the Marine brigade that arrived with them.

Under the able leadership of Lejeune and Neville, the Marines were able to reach such objectives as Souissons and Saint Mihiel, Meuse-Argonne and Mont Blanc, and St. Entienne. The Marine Corps’ courage and steely determination helped end the war by November 1918.

Marine Corps aviation had its beginning when Lieutenant Alfred Cunningham arrived at the Naval Aviation Camp, Annapolis, Md. By August 1, 1912, Cunningham had made his first solo flight. He began to generate ideas concerning Marine Corps aviation for which he became known at the “Father of Marine Corps Aviation.”

Conclusion

During the Great War, as the first world war came to be known, the Marine Corps grew in size to about 76,000. However, there were 11,366 casualties, of whom 2,459 were killed or missing in

U.S. MARINE CORPS. JROTC
Category 5 – General Military Subjects
Skill 7 – Military History

action. The history of the war is dotted with examples of Marine heroism. As President Wilson wrote to the Commandant, “The whole nation has reason to be proud of them.” As the new century moved into its second decade, the United States Marine Corps was recognized as an elite fighting force. It now had a tradition marked by successfully defending U.S. interests around the world. ❖

World War II and the Korean War

PURPOSE

The United States and the Marine Corps would be tested in the 1940s and '50s as they had never been tested before. The attack on Pearl Harbor, Hawaii, put America on alert that the world had begun to shrink and that our shores were no longer so far away as to be safe from foreign attack. The effort to recapture the Pacific from the Japanese would require a multitude of amphibious landings on heavily defended islands.

Introduction

During the 1920s and 30s, the Marine Corps managed to stay fairly active traveling the world to protect American lives and property. Most of the activity seemed to be in Latin America where Marines continued to serve U.S. interests in the Sugar Intervention in Cuba (1917-19); fighting the Cacos again in Haiti (1919-20); rebel groups in the Dominican Republic (1920-24); and Sandanistas in Nicaragua (1926-1933).

The Nicaraguan effort is worth noting. The Marines left the country in 1925 when the legation guard was removed, only to return in 1926 to establish neutral zones in response to fighting between the government and the rebels. By 1928, things had settled down enough to hold an election. In 1931, rebel leader Agustino Sandino returned and political unrest began to rise. To combat these bandits, a two-part plan was developed. This plan provided for guarding the vital points with part of the available forces, while

conducting offensive operations with the remainder. One of the most effective units to combat the bandits was led by **Captain Lewis “Chesty” Puller**. This unit became famous for its ability to find and engage the rebel groups while scouring the jungles in a wide area. For his exploits and successes against the bandits, Puller became known as the “Tiger of the Mountains.” It was for his exploits in Nicaragua that Puller won the first of his five Navy Crosses.



Courtesy of the Franklin D. Roosevelt Library Digital Archives.

World War II Begins (1941)

As early as the 1920s, it became clear that a war against Japan would require amphibious assaults against advanced bases across the Pacific. Marine Corps schools attacked the problem and produced comprehensive manuals dealing with amphibious doctrines. Materials were developed designed to enhance landing operations in the face of an enemy onslaught. Before the end of World War II, the Marine Corps trained seven U.S. Army divisions in landing operations.

The December 7 surprise attack on Pearl Harbor destroyed or disabled virtually all of the battleships docked there. Forty-seven of the 48 Marine aircraft were effectively eliminated from further action. Fortunately, four American aircraft carriers were at sea on maneuvers.

Unlike the attack on Hawaii, the Japanese bombarded Guam for two days and then sent in an invasion force of 6,000 troops. The 153 Marines were no match for those numbers. On December 10, the Commander of the island was forced to surrender, the first loss of an American outpost.

The attack on Wake Island also began with heavy bombing. The Battalion Commander, Major James P.S. Devereux, believing that the Marines at Wake would be reinforced, had his men “dig-in.” Even though they were able to sink two Japanese destroyers and shoot down seven planes, heavy bombardment took its toll. An invasion force of about 1,500 Japanese finally forced surrender on December 23. Nevertheless, the fighting at Wake displayed the power that Marines have when they are determined and willing to overcome odds, no matter how great.

In the Philippines, the Japanese launched a powerful invasion. General Douglas MacArthur was given the task of defending the beaches of **Corregidor**. After the combined American and Filipino forces were defeated at the **Bataan Peninsula** in April of 1942, it was only a matter of a month, before the Japanese were victorious at Corregidor.

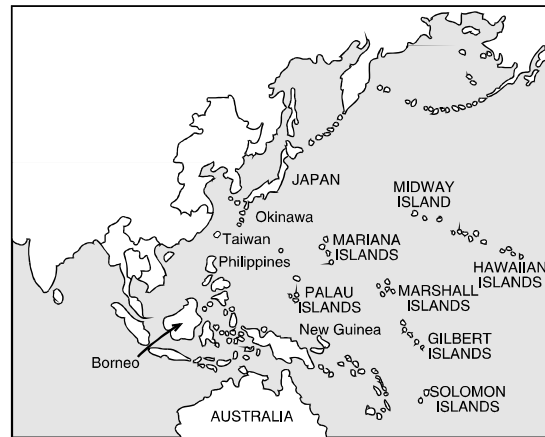

Midway (1942)

Midway Island was the turning point in the war in the Pacific because it stopped the Japanese offensive. When American Intelligence discovered that the Japanese were planning to attack Midway, Marines prepared to defend the island. When the attack came, American aircraft from the island and from the carriers in the area met the Japanese in the air. When the battle, which occurred June 4-6, was over, the Japanese lost hundreds of aircraft, their best pilots, and four aircraft carriers. Marine pilots fought courageously, but only 10 of the 25 fighter planes survived and 11 of the 27 dive-bombers were lost. Marine Captain **Richard Fleming** was awarded the Medal of Honor posthumously for diving his flaming bomber into the Japanese cruiser *Mikuma* crippling her badly.

Guadalcanal (1943)

Even though the **Allies** were primarily made up of the United States, Great Britain, and France, the war in the Pacific was mostly an American led effort. The first Pacific offensive was at Guadalcanal, a small island in the Solomon chain. There was no resistance on the beach, but Japanese air raids caused confusion in the

handling of supplies. Then the Japanese attacked, forcing the Navy to go to waters where they had a better capacity to maneuver. The Japanese also planned to reinforce the island with 50,000 men. The battles continued in the jungles for months on end. Finally, on February 9, 1943, seven months after the campaign began, the island was firmly in American hands. The cost was high. More than 1,100 Marines were killed compared with 25,000 Japanese.

The islands of New Georgia and Bougainville were also secured in 1943. The campaign to secure the Solomons was successful to a large degree because of the superiority of the U.S. air attack. Whether fighting the Japanese in the air, attacking Japanese planes, or supporting land forces through bombing attacks, air superiority was a major factor in the war in the Pacific. Two heroes of the aerial wars of the Pacific were **Major Gregory (Pappy) Boyington** commander of the Black Sheep, and Captain Joseph Foss, a Medal of Honor winner. Foss was the second ranking Marine ace with 26 victories to Boyington's 28.

The Gilbert Islands (1943-44)

In August 1943, the Allies concluded that by taking the Gilbert Islands, they could reach the Marshalls and move on to the Marianas. From the Marianas, they could attack Iwo Jima and Guam. From Guam, they could attack the Japanese home islands directly. This campaign came to be known as “**island hopping campaigns.**”

Tarawa, Betio, and Makin were the islands of the Gilberts that the Marines had to take. The approach was the same -- bombard the island prior to the landing the troops on-shore. One difficulty faced by the Marines was the problem of landing craft getting stuck on the reefs. The Marines were forced to wade hundreds of yards to the beach giving the Japanese easy targets. The

Marines succeeded with “will, courage, and esprit de corps.” The Marines learned that more accurate bombardment of Japanese defenses would be required in the future.

The Marshalls (1944)

The Kwajalein **Atoll** in the Marshall Islands was the next objective in the Central Pacific. The landing force was a combination of Army and Marines. While the Army was responsible for Kwajalein Island, the Marines were to take the islands of Roi and Namur. After setting up artillery pieces on neighboring islands, the Marines landed on Roi and Namur on February 1. The bombardment of Roi was effective, and the Japanese provided little resistance. On Namur, the resistance was tougher, but the result was the same. The Marines then moved on to take Eniwetok, Engebi, and Parry Island. By securing the Eniwetok Atoll, the Japanese in the rest of the Marshalls were cut off from their supplies and reinforcements. The Marines left them there for the remainder of the war, where many were killed in bombing raids or died of starvation or disease.

The Marianas (1944)

The Marianas Islands were important not only because they could serve as a departure point for American B-29 bombers to reach the Japanese home islands, but they could be used to lure the Japanese fleet out of hiding. For the Marianas invasion, General Holland Smith led combined invasion forces that totaled more than 136,000 troops, the largest number up to that time to operate in the field under Marine command.

Saipan

Saipan was the most heavily defended island in the Marianas. There were nearly 30,000 Japanese on Saipan.

The Marines hit the beaches on June 15 and received a bloody reception. More than 2,000 Marine casualties were reported on the first day. However, the invasion had the desired effect of drawing out the Japanese navy. At the battle of Coral Sea, the entire Japanese fleet was soundly defeated. This battle had the effect of stopping the Japanese expansion to the south. For that reason, it is considered one of the turning points of the war.

The most important area on the island was the airfield. It took ten days to capture, and the fighting was terrible. It took another fifteen days to control the island. The tally in dead and wounded was enormous. The Americans lost more than 3,000 and another 11,000 were wounded. The Japanese lost more than 25,000 of their soldiers and another 1,800 were taken prisoner.

Guam

Guam was the next island in the Marianas that the U.S. attacked. The island is 225 square miles of rugged, volcanic terrain fringed with coral. As in other amphibious landings, Guam was pounded regularly from the air by carrier-based aircraft and from the sea by battleships, cruisers, and destroyers. After 13 days, the enemy's defenses were weakened, but their resistance was still strong. It took five days before the Marines were able to gain control of the high ground. The Japanese then began a series of counter-attacks that at times seemed suicidal in nature. Ultimately, the fighting ended in August and the conquest of the Marianas was complete. However, some of the Japanese were so entrenched in the caves that dot the island that it was not until 1972 that the last Japanese soldier surrendered. Japanese losses were put at nearly 18,000 dead while the number of Marines killed reached nearly 2,000.

Iwo Jima and Okinawa (1945)

Before the United States could think about invading Japan, there were two more islands that needed to be taken. These two islands were Iwo Jima and Okinawa. Iwo Jima was needed to provide a fighter base so that they could protect the B-29 bombers taking off from the Gilbert Islands. Okinawa would provide a staging point for the invasion of Japan.

When the Marines landed on the beaches of Iwo Jima on February 19, they encountered little opposition. The Japanese could have caused tremendous damage to the landing party from their lofty defensive positions at the top of Mt. Suribachi. However, the Japanese decided to wait until all of the assault battalions had hit the beach. At this point, they hit the Marines with machine guns, mortars, and light and heavy artillery.

It required several days of hard fighting for the Marines to take Mt. Suribachi. When they reached the summit, the Marines raised a small American flag. Later, a much larger flag was raised and a photographer snapped a picture of the five Marines and a hospital corpsman as they raised the Stars and Stripes over the Japanese fortress. Three of those men were later killed in action and a fourth was wounded. That photograph became famous and today is represented by the inspirational sculpture of the flag raising in Arlington, Va.

One of the most difficult aspects of taking the island was the use by the Japanese of tunnels and caves. The Japanese fought fiercely, but 71,000 Marines, 5,000 of whom died, would not be turned away. On March 16, the island was under American control. Admiral Nimitz said of the battle for Iwo Jima, "Uncommon **valor** was a common virtue."

The last great battle of the war for the Marines was at Okinawa. The Marines were under the command of Major General Roy Geiger. Of the combined Army and Marine troops involved in the invasion, 81,165 were Marines.

The campaign for Okinawa lasted from April 1 to June 21. Between 55,000 and 65,000 determined Japanese were making their last stand. As in the case of Iwo Jima, the Japanese waited until the Marines had moved onto the island before firing. The Marines were faced with three lines of defense set up by the Japanese as well as fighting through hills, ridges, rain, and fatigue. By the end of May, the Japanese were pushed back to their last line of defense.

As it was throughout the “island hopping campaign,” the use of Marine Corps aviation was extremely important. Marines shot down 82 enemy planes at Okinawa and destroyed another 149 on the ground. The coordination of the sea, land, and air effort was critical to the success of the Pacific campaign. By the end of the Okinawa effort, General Geiger was in command. When General Buckner was killed, Geiger became the only Marine officer to ever command a field army.

The End of World War II

It was estimated that the invasion of Japan could cost as many as 100,000,000 American lives. To ensure that did not happen, President Harry Truman ordered the B-29 “Enola Gay” to drop the atomic bomb on Hiroshima on August 6, 1945. Three days later, a second bomb was dropped on Nagasaki. The devastation was so horrible that the Japanese asked for peace on August 14.

While the war with Japan was over, the U.S. still had to deal with the after effects. China was being fought for by Nationalists and

Communist Chinese. The U.S. provided some support for Chiang Kai-Shek and the Nationalists, but by 1949 his army was relegated to the small island of Formosa (Taiwan). While the Marine effort in China came to an end, they were destined to meet Chinese soldiers again before long.

Korea (1950-1952)

At the end of World War II, the 38th parallel was established as the military boundary between the American and Soviet troops. It also served as a “**bamboo curtain**” separating the democratic government of South Korea from the communists to the north. When the North Korean People’s Army (NKPA) crossed the 38th parallel into South Korea in June of 1950, the Marine Corps was called back into action. While the NKPA rolled southward toward Seoul, the capital, the South Korean armies were only able to provide token resistance. In response to these acts of aggression, the United Nations Security Council called on nations of the world to help move the North Koreans back to their side of the 38th parallel. The United States and 20 other nations announced that they would support the UN resolutions. Marine Commandant General Clifton Cates suggested to General MacArthur that the Marines participate because they were a “force in readiness.”

According to MacArthur’s plan, the 1st Division would land at **Inchon** and fight its way to Seoul. Then the 8th Army would fight its way out of the **Pusan** perimeter and pound the NKPA against the Marine defensive front using a “**hammer and anvil**” strategy. Pusan, however, would prove to be a difficult place to hold.

Pusan

By early August, South Korean forces were confined in the southeastern corner of the

peninsula to a territory 140 kilometers long and 90 kilometers wide. Apart from this “Pusan Perimeter” around the port of Pusan, the rest of the territory was completely in the hands of the North Korean army. When the Marines arrived at Pusan, Brigadier General Edward Craig described the situation in this way:

The Pusan perimeter is like a weakened dike, and we will be used to plug holes in it as they open. It will be costly fighting against a numerically superior enemy. Marines have never lost a battle. This 1st Brigade will not be the first to establish such a precedent.

The Pusan perimeter was important to the strategy for defeating the North Koreans because it served as a base for the counter-offensive that would retake South Korea. In the “hammer and anvil” strategy, Pusan was the anvil.

With the support of fighter-bomber squadrons, a position was secured near Sanchon by August 13. The Marines were then called to an area near the Naktong River called “No Name Ridge.” Against heavy odds, the Marines pushed forward again receiving strong air support. By nightfall on August 17, the northern part of the ridge had been secured. During the night, the Marines fended off one counterattack after another. The Marines renewed their own attack the next day, and by late afternoon the ridge was secured. No longer holding the higher ground, the NKPA were forced to retreat across the Naktong River. The Marines, using fighter-bomber squadron close air and artillery support, were able to virtually eliminate the 4th North Korean Division. The Pusan perimeter was now secure.

Inchon

Now that the “anvil” was in place, it was time to secure the “hammer.” Inchon would be the site for the invasion of South Korea from the north. For several days prior to the September 15 invasion date, carrier based planes and warships bombarded Inchon harbor and the Inchon waterfront. This preparatory fire was so effective that Lt. Colonel R.D. Taplett’s 3rd Battalion, 5th Marines, took only 25 minutes to secure the island of Wolmi-do and open the causeway to Inchon. The most difficult aspect of taking Inchon was negotiating the high tides and seawall. Using scaling ladders to get over the seawall, Marines were able to secure a beachhead by the afternoon of the second day. The resistance became stiffer as the Marines advanced toward Seoul. After two days of bitter fighting, the NKPA collapsed, and Seoul was back in the hands of the South Koreans. The North Korean invasion had lasted three months and four days.

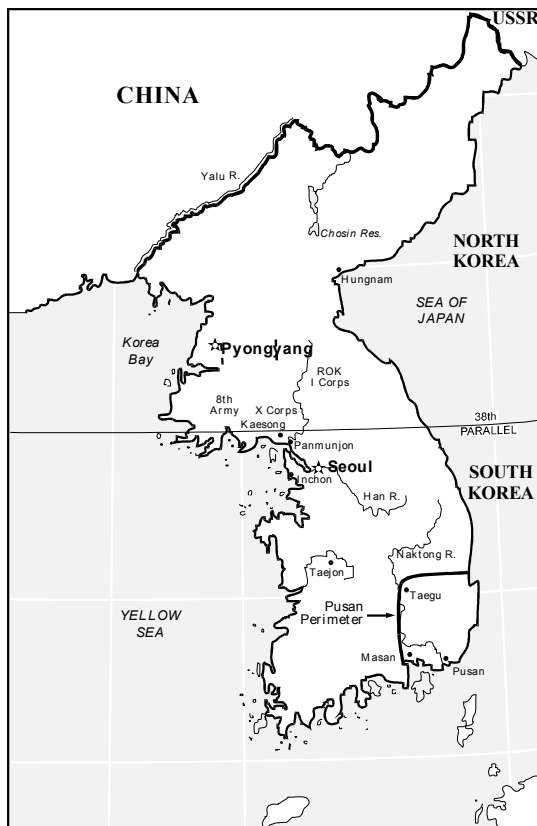

Crossing the 38th Parallel -- the Chosin Reservoir (1950)

The North Koreans fled to the 38th parallel. The military plan now called for an advance to the Yalu River that forms the border between North Korea and Manchuria. The first step was to take the hydroelectric plant at the Chosin Reservoir. It was in this effort that the Marines made their first contact with the forces from the People's Republic of China (PRC) at the battle of Sudong. After four days the Marines were able to severely cripple elements of the Chinese Communist forces. The Marines reached the Chosin Reservoir by November 13. At this point, there was concern about the on-coming winter weather and the Division being overextended.

The Marines were now ordered to move along the road to Yudam-ni through the Toktong Pass. Colonel Lewis "Chesty" Puller's 1st Marines were strung out along the Main Supply Route. The 5th Marines moved to the west on November 27. That night it snowed, and the temperature dropped to 20 degrees below zero. Suddenly eight divisions of Chinese came pouring out of the mountains intent on destroying the 1st Marine Division. The Marines were surrounded. There was concern that the Marines' equipment would have to be abandoned and that the Marines would have to work their way back to Hungnam. When asked if the Marines were retreating, Smith responded, "Retreat! We are coming out as a Marine division. We are bringing out our equipment, our wounded, and our dead. Retreat Hell! We're just fighting in the other direction."

The going was difficult. The Marines were forced to leapfrog rifle companies along the high ground on the side of the MSR so that the convoy would be safe. The convoy itself was an inviting target. Trucks, jeeps, tanks, and Marines were

jammed together on the narrow mountain road. The dead and many of the wounded were lashed onto the vehicles. The weather was brutally cold and in many places there was only a steep cliff on one side and a solid wall of mountain on the other. There was little margin for error.

On the final march to the sea, the Marines would be forced to fight the Chinese every step of the way. Finally, on December 12, the Marines reached Hungman. Out of a total of 4,400 casualties, 730 were killed. The Chinese had lost 25,000. The division that had been given up for dead was safe, and they had brought out their equipment and wounded. The spirit of the Marines was aptly expressed by Colonel Puller when he said, "They have us surrounded. They won't get away this time."

The fighting in Korea now centered around the 38th parallel. It resembled the trench warfare of World War I. The fighting was confined mostly to small unit attacks and skirmishes.

Truce

The truce negotiations with the Chinese and the North Koreans began in July 1951. It was not until two years later that a ceasefire took effect on July 27, 1953. In between these times, the war became increasingly unpopular and played an important role in the Presidential election of 1952. In that campaign, former General Eisenhower pledged to Korea to end the war. After he was elected, Eisenhower threatened to use nuclear weapons. When the truce was signed, the U.S. had lost 54,000 killed and 103,000 wounded. Casualties for the Chinese were estimated at ten times that number. After all was said and done, the 38th parallel was again the border between the Republic of Korea to the south and the People's Republic of Korea to the north.

At the beginning of the Korean War, General Douglas MacArthur was appointed commander of U.N. military forces in South Korea. After driving the North Korean forces back over the 38th parallel, MacArthur received President Truman's permission to press into North Korea and advance all the way to the Yalu River, the border between North Korea and Manchuria, despite warnings that this might provoke Chinese intervention. When China did intervene, causing the U.N. forces to fall back in disarray, MacArthur pressed for permission to bomb Chinese bases in Manchuria. Truman refused such permission and finally (after MacArthur had made the dispute public) removed him from command in April 1951. General Matthew Ridgeway replaced MacArthur.

Conclusion

World War II and the Korean War were instrumental in demonstrating an ongoing need for the Marine Corps as a force in readiness. President Truman signed the Douglas-Mansfield Bill that provided that the Marines were a separate branch of the military and should be treated as such. The law put the size of the Marine Corps at three active divisions and three air wings. It also gave the Commandant of the Marine Corps equal footing with the Joint Chiefs of Staff when matters concerning the Marine Corps were being discussed. The Korean War also initiated the use of helicopters in battle, as well as developments in the use of flak jackets, and new types of boots.❖

The Marines in the Modern Era

PURPOSE

With the end of the Korean War, it became apparent that the traditional war was a thing of the past. The remainder of the twentieth century brought the Marine Corps into a number of conflicts ranging from providing support for Americans and their property abroad (Dominican Republic, Lebanon, Somalia) to full-scale combat engagements in Vietnam and the Persian Gulf. In every case, it was apparent that the value of the Marines was increased by their ability to be a Force in Readiness.

Introduction

The armistice in Korea did not mean that the Marine Corps ceased to be involved in international activities. Whether helping to evacuate refugees in both China and Vietnam or providing relief assistance in the Ionian isles of Greece and in Tampico, Mexico, the Marines helped out whenever and wherever they were needed. When a 1958 revolution in Iraq threatened the stability of Lebanon, its president requested American troops to support the Lebanese army. From July to October of that year, Marines worked in close cooperation with the Lebanese government and Army units to control the internal strife. This type of limited activity depended on the alert readiness of the Marine Corps. Constant and world-wide readiness was exemplified by the Marines moving into the South China Sea in 1960 following a communist invasion of Laos and a Marine helicopter squadron moving

into Thailand to provide logistic support for the Laotian government. Other Marine forces were on station, both ashore and afloat, in other parts of the world, and were prepared for any action—from putting out a brushfire conflict to waging an all-out war.

Dominican Republic (1965)

When Donald Reid Cabral, President of the Dominican Republic was assassinated in April 1965 as part of a **coup**, the Marines were called in to protect U.S. citizens who wished to leave the area. The Marines used helicopters and Battalion Landing Teams (BLTs) to evacuate American personnel. By nightfall, nearly 1,200 persons had departed the island.

On April 28, Colonel Pedro Bartolome Benoit asked for the help of Marines to help restore order. On the April 29, 1,500 Marines were ashore at Santo Domingo. By May 6, the Organization of American States (OAS) agreed to a proposal suggested by the U.S. to form and Inter-American Peace Force to restore peace and a constitutional government to the Dominican Republic. Small units from Paraguay, Honduras, Nicaragua, Costa Rica, and Brazil joined the Marines and the U.S. Army and engaged rebel bands in sporadic firefights until peace was restored. The Marines left the island by June 6. They had reached a force of 8,000 troops, nine of whom were killed.

Vietnam (1965-1973)

The war in Vietnam may have begun for the United States in 1965, but it started for the Vietnamese 100 years before. Vietnam had been under the control of the French and later the French and Japanese. The fight for independence in Vietnam had been a long one. Ironically, the **Vietminh**, a nationalist organization led by communists, was thought by many to have U.S. support in the years prior to the end of World War II. The Japanese controlled Vietnam during World War II. In early May of 1945, the U.S. bombarded the port of Da Nang and sank fourteen Japanese warships and thirty-three merchant ships were destroyed, the largest number sunk by the U.S. Navy in any one day in the entire war. The Vietminh and a coalition of British-French resistance fought the Japanese. Ultimately, the Japanese surrendered to the Vietminh.

While the end of the war left Vietnam united and independent, the French were not about to give up their desire to retain Vietnam as part of the French Empire. Vo Nguyen Giap led the Vietminh army. His “guerilla” forces began to take more and more of the territory from the French. 1954 began with new communist offensives menacing South Vietnam, central and northern Laos, and the northeast of Cambodia. On May 8, 1954, the French base at Dien Bien Phu suffered a major defeat after a heavy artillery attack from Giap’s forces. The French forces in North Vietnam evacuated to below the 17th parallel. On July 7, 1954, Vietnamese Emperor Bao Dai appealed to Ngo Dinh Diem, the prime minister for support. Bao Dai wished to lead the country with the support of the United States, but a referendum held in October decided to uphold Diem as the leader of the South Vietnamese. Bao Dai was deposed on October 26, 1955, marking

the end of the Nguyen Dynasty and the beginning of the Republic of South Vietnam.

The war for independence officially ended on July 20, 1954, after the long negotiations in Geneva. In finally gaining full national independence, Vietnam lost its unity. The Geneva agreement signed in August 1954, divided the country at the 17th parallel pending general elections scheduled for the middle of 1956. The North became the Democratic Republic of Vietnam under the leadership of the Lao Dong party and Ho Chi Minh, and the South became the Republic of Vietnam. In April 1956, the last French troops left Vietnam. The reunification elections never took place. The result was a civil war between north and south that lasted 20 years. Communists located in the south came to be called **Viet Cong (VC)**.

In late July and early August of 1964, the U.S. destroyer *Maddox* was on a reconnaissance mission in the Gulf of Tonkin. According to President Johnson, the ship suffered an unprovoked attack by North Vietnamese torpedo boats. President Johnson then ordered bombing of North Vietnam and asked for support from the Congress.

The **Gulf of Tonkin Resolution** gave the president the authority to use any measure necessary to deal with aggression in Vietnam. Because of this measure, President Johnson was able to increase troop numbers in Vietnam.

The United States began providing military assistance to South Vietnam as early as 1954, but the major U.S. buildup did not begin until the 1960s. In February 1965, shortly after the celebration of Tet—the Vietnamese Lunar New Year—the Viet Cong attacked two U.S. military installations killing and wounding a number of U.S. advisors and maintenance personnel. President Johnson ordered the bombing of North Vietnam. On March 6, the Pentagon announced that two battalions of Marines, numbering 3,500 men, were being sent to South Viet Nam. On March 8, the Marines took on the role of defending the Da Nang airbase. By the end of the summer of 1965, there were four infantry regiments in Viet Nam.

The first ground operation by the Marines in Vietnam was the result of information that indicated that Viet Cong were going to attack the airfield at Chu Lai. On August 18, the Marines began their first regimental-sized battle by U.S. troops since Korea. Hitting the enemy on three sides, **Operation Starlite**, as it was called, was the successful use of the theory of “vertical envelopment.” The theory called for using helicopters to insert Marines behind enemy beach defenses. By August 24, about 700 Viet Cong had been killed: a planned attack against Chu Lai had been frustrated; and the Viet Cong learned that it would be a difficult task to defeat the Marines in a standup battle.

The **Pacification** program was an effort to bring the villages of South Vietnam into the fold of the government of the Republic of Vietnam. The idea was that individual villages would be freed from Viet Cong influence. They would then be provided with security and help by the South Vietnamese government. The Viet Cong controlled much of the countryside with the Marines controlling the urban areas. For the most part the Viet Cong concentrated their efforts on guerilla and terrorist activities.

The Marines were also involved in **Operation Golden Fleece** designed to protect the rice harvest for the people and away from the enemy. **Operation County Fair** was designed to win the confidence of the people by helping them with health and sanitation problems. During these operations in the villages outside Da Nang, the Marines dug wells, built schools, funded orphanages, supplied hospitals, and distributed food.

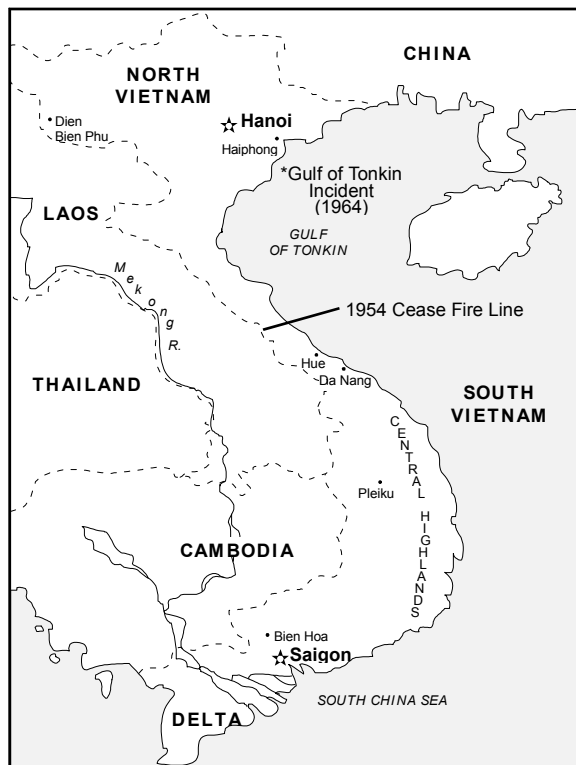

The **Ho Chi Minh Trail**, also called Truong Son Trail, was an elaborate system of mountain and jungle trails linking North Vietnam, South Vietnam, Cambodia, and Laos during the Vietnamese War. It provided the VC with supplies, ammunition, and troop support.

As 1965 ended, 180,000 U.S. troops were in Vietnam and 38,000 of those were Marines. In the next two years, efforts were focused on stopping the North Vietnamese Army (NVA) from entering South Vietnam. The Marines were committed in the vicinity of the Demilitarized Zone (DMZ) in July 1966. Reports that a large force of North Vietnamese Army had crossed the 17th parallel brought Marines into preparation for the bloodiest battle yet. It involved 8,000 Marines and 3,000 South Vietnamese. The bombing by B-52s helped stop the onslaught. Thereafter, the Marine buildup continued in the DMZ area as the North Vietnamese continued in their attempts to cross over.

By 1968, the Marines were under the command of Lieutenant General Robert Cushman. On January 20, Marines near the village of Khe Sanh in Quang Tri province made contact with a battalion sized force of the NVA. By the next day, the North Vietnamese had taken the village of Khe Sanh. On January 27, the base was reinforced with additional Marines and with troops from the Army of the Republic of South Vietnam (ARVN). Even though the North Vietnamese had agreed to a four-day truce during the lunar holiday, the VC broke that truce by attacking Da Nang, Marble Mountain, and Chu Lai with rocket attacks. Attacks against the provincial capital followed. In Hue, the ancient Vietnamese capital, the VC took control of the

city. The Marines were forced to fight house-to-house. Marine training, equipment, and courage overcame a numerically superior force.

Meanwhile Khe Sanh was still under siege. On April 1, the Marines began operation Pegasus, designed to secure Khe Sanh. The heavy use of tactical air support and the transport by planes and helicopter of fresh troops, food, ammunition, and medical supplies resulted in the lifting of the siege by April 12. By the end of April, the VC launched another offensive, but they were repulsed. In August, the enemy launched another attack. The Marines stood firm again.

In the spring of 1969, President Richard M. Nixon initiated his new policy of “**Vietnamization.**” Vietnamization had two distinct elements: first, the unilateral withdrawal of American troops from South Vietnam; and, second, the assumption of greater military responsibilities by the South Vietnamese armed forces to make up for that loss. Military planners had based previous withdrawal plans on reductions in enemy forces. Vietnamization rested on the twin assumptions that the combatants would not reach any kind of political settlement, or understanding, and that the fighting in the South would continue without any voluntary reduction in enemy force levels.

In the summer of 1969, the Marines began to go home. The offensives against the VC were led by the ARVN with the Marines acting as support troops. One of the last missions of the Marines was participation in a mine sweep of Haiphong Harbor in July of 1973. The last great effort by the Marines came in 1975 as they returned to Southeast Asia to protect Americans who were being evacuated from Vietnam and Cambodia. The Vietnamization plan was successful in that it extricated American troops

from Vietnam, but it was unsuccessful in that the communists took control of the country. In the end, the Vietnamese War was the longest in our history. U.S. casualties in Vietnam during the era of direct U.S. involvement (1961–72) were more than 50,000 dead. South Vietnamese dead were estimated at more than 400,000 and Viet Cong and North Vietnamese at over 900,000.

The Mayaguez Incident

In May of 1975, the Khmer Rouge in Cambodia boarded and seized the U.S. merchant ship *Mayaguez* and captured her crew in international waters. The ship was enroute from Hong Kong to Thailand carrying non-arms supplies to the U.S. military base. President Ford ordered the Marines to the rescue. The Marines were sent from Okinawa to Thailand and airlifted by the Air Force into Cambodia. On May 15, the Marines boarded the *Mayaguez* and hoisted the American flag. At the same time, the Cambodians were returning members of the *Mayaguez* crew on a captured Thai fishing boat. Marines were meeting heavy resistance, but once it was known that the crew was safe, the Corps was evacuated. In all, 11 Marines, 2 Navy corpsmen, and 2 airmen had died in what seemed to be a senseless act of piracy.

In 1976, the Appropriations Authorization Act officially made the Commandant of the Marine Corps a permanent equal member of the Joint Chiefs of Staff. Up until this time, the Commandant was only allowed to have input on policies, functions, personnel, programs, and fiscal resources that related directly to the Corps.

The Middle East

During the late 70s, the Middle East became a hot spot for Marine activity. Two U.S. embassies were attacked in the same month. One incident occurred on November 21, 1979 in Islamabad, Pakistan where a Marine Corporal Stephen Crowley was killed while performing his duties. The embassy was set on fire. The 137 civilians were forced onto the top of the building, and Crowley, forbidden to use deadly force against the mob, was killed. The Marines used tear gas and fired over the mob's head until government forces could arrive.

The second incident was in Tehran, Iran in November of 1979. Nine Marines and 43 civilians were held hostage for 444 days. Sgt. Jimmy Lopez was credited with controlling the front of the embassy and holding off the attackers for more than three hours. He was also responsible for aiding the escape of five U.S. citizens to the Canadian Embassy. For their actions, the Marines were awarded the Defense Meritorious Service Medal.

On President Carter's last morning in office, 444 days after their abduction, the Iranians agreed to a deal. It gave them \$8 billion worth of Iranian assets that had been frozen, \$5 billion of which was set aside to pay off Iran's debts to American and European banks, in return for the release of the hostages, who flew out of Tehran that day.

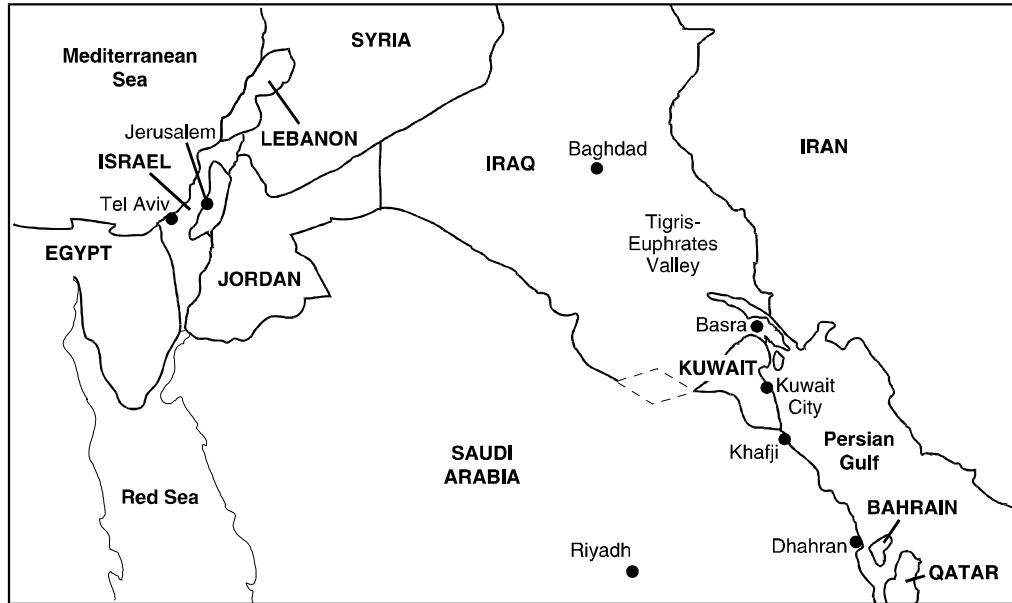

Persian Gulf

Lebanon and Grenada

The Marines were sent to Lebanon on a peacekeeping mission in June 1982 following an Israeli invasion of that country. On October 23, 1983, a yellow five-ton Mercedes truck roared into the parking lot at high speed, and then crashed through a barbed-wire barrier. The truck moved past two sentry posts, went through a gate in an iron fence, hurdled over an obstacle made of sewer pipe, plowed through a sandbag barrier, and crashed through a four-foot-wide door into the lobby of the building where the cargo, equivalent to six tons of TNT, detonated. Two hundred thirty-nine occupants of the building were killed immediately including 218 Marines. An investigation showed that the terrorists were Iranians sponsored by the Syrian government. President Reagan eventually recognized that it was time to move the Marines out of Beirut except to protect the embassy. By July 31, 1984, the last of

the Marines departed. A total of 238 Marines had been killed in actions related to Lebanon.

In 1983, the Organization of Eastern Caribbean States sent a message to the U.S. requesting American support to deal with what was called an unprecedented threat to the peace and security of Grenada, a small island in the Caribbean and a member of the British Commonwealth. There were approximately 1,000 U.S. citizens there, mostly students at the St. George Medical School. Because President Reagan feared the expansion of Cuban and Soviet influence there, he ordered the Marines to move in. On October 25, the Marines landed; by October 29, seven-eighths of the island was under control. Close to two hundred civilians were evacuated. By late afternoon on November 2, the Marines had returned to their ships.

Panama

“**Just Cause**” was the name of the operation whose goal was to bring Panama’s dictator and drug-dealer, Manuel Noriega to Florida for trial. Marine activity was limited. Panama would give the Marines the opportunity to use its anti-terrorist teams and its light-armored vehicles (LAVs). Part of the Marine responsibility had been to defend the Navy’s Arraijan Tank Farm, which stored in underground tanks most of the fuel used by all of the U.S. forces in Panama. In December 1989, Lt. Robert Paz and three other officers went to dinner in Panama City. They were stopped at a Panamanian Defense Force (PDF) checkpoint and tried to drive away. Lt. Paz was killed by the PDF. Shortly thereafter, Operation Just Cause was put into effect. On December 20, Col. Charles Richardson was ordered to take the 10th Military Zone in La Chorrera. By that afternoon, the LAVs had rolled into La Chorrera stabilizing the area. By Christmas Eve the fighting was over. On January 3, 1990, Noriega surrendered. Within two weeks, the Marines had departed; their numbers never exceeded 650.

Kuwait and Iraq

In 1990, Arab Gulf states refused to agree with Iraqi leader Saddam Hussein’s plan to cut production and raise the price of oil. Iraq had incurred a huge debt during its war with Iran that had lasted for most of the previous decade. After weeks of massing troops along the Iraq-Kuwait border and accusing Kuwait of various crimes, Hussein sent seven divisions of the Iraqi Army into Kuwait in the early morning hours of August 2, 1990. The invasion force of 120,000 troops and 2,000 tanks quickly overwhelmed Kuwait. Hussein announced that Kuwait was his nation’s nineteenth province. The United Nations

responded quickly, passing a series of resolutions that condemned the invasion, called for an immediate withdrawal of Iraqi troops from Kuwait, imposed a financial and trade embargo on Iraq, and declared the annexation void.

Because of the threat to a vital interest of the U.S., the oil production capability of the Persian Gulf region, President George Bush ordered warplanes and ground forces to Saudi Arabia after obtaining King Fahd’s approval. Iraqi troops had begun to mass along the Saudi border. Operation **Desert Shield**, the U.S. military deployment in Saudi Arabia, grew rapidly to become the largest American deployment since the Southeast Asia Conflict. The purpose of Operation Desert Shield was to provide a show of force to the Iraqi military in an effort to force them to pull back without fighting and also to protect Saudi Arabia in the event the Iraqi army decided to move south. Eventually, 30 nations joined the military coalition against Iraq, with a further 18 countries supplying economic, humanitarian, or other types of assistance.

On August 10, General Norman Schwarzkopf called for three Marine Expeditionary Brigades to be included in the repositioning concept. Marine Major General Robert Johnson joined the Central Command as chief of staff.

On Jan. 15, 1991, President George Bush sent a memorandum to his main national security advisors, outlining the goals of the coming conflict with Iraq. The president was explicit in focusing U.S. military efforts in four major areas:

- To effect the immediate, complete and unconditional withdrawal of all Iraqi forces from Kuwait;
- To restore Kuwait’s legitimate government;

- To protect the lives of American citizens abroad; and
- To promote the security and the stability of the Persian Gulf.

By the time the memo, known as National Security Directive 54, made it to the desks of his advisors, plans had already been well underway to achieve the president's goals.

Operation **Desert Storm** included massive air attacks designed to cripple Hussein's offensive and defensive forces. It incorporated attacks on Iraqi ground forces and folded in the use of the Navy and Marine Corps, coalition aircraft and Tomahawk cruise missiles. General Schwartzkopf's four-phase plan included the following:

- Phase I -- Strategic air command to attain air supremacy;
- Phase II -- Tactical air supremacy in the Kuwaiti theater
- Phase III -- Preparation of the battlefield to reduce the combat effectiveness of the enemy; and
- Phase IV -- Ground offensive with penetration, exploitation, pursuit, and consolidation.

January 16, 1991, was D-day. Before dawn on that day the air campaign began. The Iraqis had twice as many troops, four times the number of tanks, and five times the number of artillery. When the air attacks were concluded, General Schwartzkopf estimated that the air effort had reduced Iraq's front line divisions by 50 percent and the second line divisions by 25 to 50 percent.

Lieutenant General Walter Boomer served as commander of the 1st Marine Expeditionary Force and the commander of the

Marine services component at Central Command. When the ground forces attacked on February 24 (G-day), General Boomer's Marine strength was at 79, 751, of whom 11, 703 were reservists and 1,335 women. At its peak, the Marine numbers were nearly 93,000. Thirty-one thousand reservists were activated. All the Marine ground troops wore Mission Oriented Protective Posture (MOPP) chemical protective suits and boots. Masks and gloves were to be added at the first sign the Iraqis were using gas or other chemical weapons.

On February 28, President Bush called an end to the attack. In 100 hours, the Marines could claim 1,040 enemy tanks, 608 armored personnel carriers, and 432 artillery pieces captured or destroyed. An estimated 22, 300 enemy prisoners were taken as well. Eighty-eight Americans were killed. General Schwartzkopf was quoted as saying, "I can't say enough about the two Marine divisions. If I used words like brilliant, it would really be an under description of an absolutely superb job that they did in breaching the so-called impenetrable barrier."

Somalia

In July 1991, Carl Mundy, Jr. became the new commandant. The largest deployment in Mundy's years as top Marine came in Somalia in 1992 and again in 1995. In 1991, the Marines had helped evacuate more than 260 persons from the U.S. embassy due to civil unrest. When the government there came apart, it was not long before many people were starving. President Bush initiated an effort to airlift food and supplies called "Project Relief."

When fighting began between rival political groups, the 11th Marine Expeditionary Unit, who had been waiting offshore, sprang into action. On December 4, President Bush

announced that U.S. troops were being sent into Somalia to reduce the famine and prepare the way for a U.N. peacekeeping force. General Robert Johnston, who had been General Schwartzkopf's chief of staff, moved forward with **Operation Restore Hope**. Johnston was the Joint Task Force, Somalia commander and Maj. Gen. Charles Wilhelm would be the commander of the Marine Forces, Somalia. Each political group was assured that the Americans would be neutral. As part of their role in the delivery of food, Marines confiscated weapons. In the absence of a formal government, Marines were forced to learn the clan system of the Somalis.

While the effort to provide help for the Somali people was a U.N. sanctioned effort, many of the troops were from the U.S. Moving to areas of fighting and trying to restore order was a difficult task at best. Gradually, the Marine involvement lessened and by March 25, 1994, the last of the troops was withdrawn. One year later, the Marines returned to cover the withdrawal of U.N. troops.

Humanitarian Aid

In an ever-changing world, it has become necessary for the Marines to evolve as well. The demand for engagement through forward presence and crisis response places a new emphasis on a broad base of Marine activity. Forward operating naval expeditionary forces are a highly flexible, cost-effective means of maintaining a global presence. The ability to move quickly is essential to providing appropriate crisis response. As a consequence, Marines are being called upon to provide not only military, but humanitarian aid in a variety of locations in the U.S. and abroad.

Since 1992, Marines have supported the enforcement of the "No-fly Zone" in Iraq and

between 1993-95 in Bosnia. Starting in 1995, Marines have supported efforts for the accounting of POWs/MIAs from the Vietnam War. In 1997, Marines provided security operations in support of humanitarian assistance for the relocation of Kurdish foreign service nationals. In South America, Marines provided support for counterdrug radar and communications. In January 1997, Marines helped reinforce the levy on the San Joachine River in Lathrop, CA. Marines have provided assistance during blizzards in the Dakotas and flooding in the Central and Western United States. These types of responses typify Marine readiness, willingness, and capability to support civil authorities.

Conclusion

With the close of the twentieth century, the Marine Corps was forced to face a new set of criteria for engaging in battle in the new millennium. General Charles Krulak, the new commandant, recognized that, "New concepts, new organizations, and new equipment will be needed to keep ahead of our opponents." These concepts put into action quickly won the war in the Persian Gulf. In 1995, General Krulak assigned the Warfighting Laboratory at Quantico the task of investigating new and potential technologies and evaluating their impact on how the Corps was to organize, equip, educate, and train Marines in the future. No one could predict where or in what form conflict would take place in the twenty-first century. History tells us that it will occur and that the Marines will be ready. ❖

The History of Marksmanship

PURPOSE

This lesson introduces you to the historic applications of marksmanship and its current application as a sport.

Introduction

There are many different sports. Among them are several sports that are classified as marksmanship or target sports. In those sports, guns or bows, which originated as weapons of war but now are items of sports equipment, are used to aim and fire projectiles at targets. Today the warrior's bow and the soldier's gun have been adapted to the challenges of target sports where they are used with amazing precision to consistently hit distant, difficult targets.

In target shooting competitions, the objective is to see how close competitors can place their shots to the centers of their targets. These marksmanship tests are as old as human history. When stones were weapons, humans **practiced** throwing them at designated marks to improve their **accuracy** or to enjoy games of **skill**. Eons later, humans engaged in marksmanship contests with slings and spears. The development of the bow and arrow and later the crossbow and firearm made far greater accuracy possible and led to the creation of today's precision target sports.



From the time humans started throwing stones they have practiced their skills at using projectiles to hit targets. This sculpture of a primitive man throwing a stone is part of a statue on the Enrique Borbonnet Gomez shooting range near Havana, Cuba.

Marksmanship Sports in the Olympics

- Biathlon, cross country-skiing, and rifle shooting
- Pentathlon, horse riding, fencing, swimming, running, and air pistol shooting
- Archery, with bows and arrows
- Shooting; 17 events for rifles pistol and shotguns

A Historical Overview

The evolution and development of target sports led to the development of four different sports that now are Olympic sports. The winter sport of biathlon combines cross-country skiing and rifle shooting. Modern pentathlon, archery, and shooting all are summer Olympic sports.

Archery involves shooting with bows and arrows. Pentathlon combines air pistol shooting with horse riding, fencing, swimming, and running. The sport of shooting is one of the largest and most popular of all Olympic sports with 17 different men's and women's events for rifles, pistols, and shotguns.

From ancient warriors to modern Olympic gold medallists, persons who demonstrated great skill in marksmanship tests were celebrated as heroes. Several ancient Egyptian Pharaohs were acclaimed for their archery skills, as shown on the inscriptions in their tombs. The legendary tales of medieval heroes, like William Tell of Switzerland and Robin Hood of England, celebrate their ability to hit especially difficult targets with a crossbow or bow. The development of America is highlighted by feats of marksmanship by the Minutemen of Concord and Lexington, frontiersmen like Daniel Boone, and military figures like Berdan's Sharpshooters.

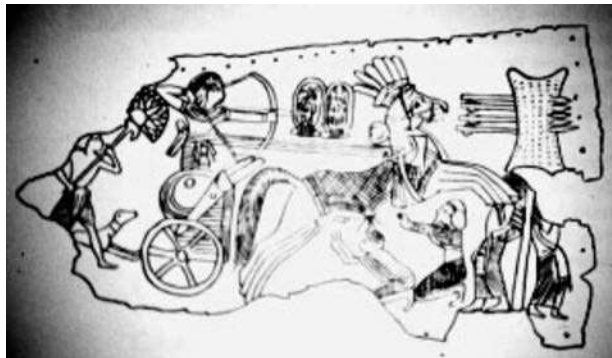

The Egyptian Pharaoh, King Aye, was the successor to Tutankhamen, the famed King Tut. This drawing is copied from an inscribed gold leaf that shows the Pharaoh shooting his bow at a target that is held by two prisoners, while he rides by in his chariot.

In the last 150 years, people who demonstrated exceptional skills while shooting at targets, from Annie Oakley to the gold medallists of the most recent Olympic games, were raised to positions of honor. Target shooting is a sport that requires precise muscle **control**, intense **concentration**, mental and physical stamina, and unwavering emotional control. No matter when in human history great feats of marksmanship are performed, the skilled marksman is respected, honored and celebrated.

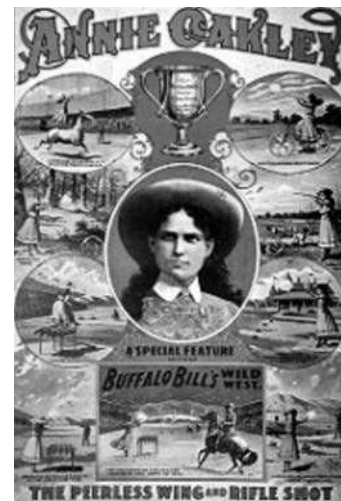

An advertising poster for Buffalo Bill Cody's Wild West Show of the late 1800s promotes the marksmanship skills of one of America's first great target shooters, Annie Oakley.

Olympic Competitors

Some of the greatest Olympic competitors are rifle shooters from the United States who were trained by the U.S. Army Marksmanship Unit at Fort Benning, Ga. Two of those shooters, Gary Anderson (1964, 1968) and Lones Wigger (1964, 1972) are among an elite group of Olympic medallists who have won two individual Olympic gold medals. No shooter from any nation has yet won more than two

U.S. MARINE CORPS. JROTC
Category 5 – General Military Subjects
Skill 8 – Marksmanship

individual gold medals. One other U.S. rifle shooter, Morris Fisher (1920, 1924), who was a member of the Marine Corps, also won two individual Olympic gold medals.

Since 1948, six other U.S. rifle shooters have won Olympic gold medals. They are Arthur Cook (1948), John Writer (1972), Lanny Bassham (1976), Edward Etzel (1984), Pat Spurgin (1984), Launi Meili (1992), and Nancy Napolski-Johnson (2000). Another important milestone in the history of marksmanship occurred in 1976, when Margaret Thompson-Murdock of the U.S. won a silver medal to become the first woman to ever win an Olympic medal in shooting. The U.S. Army Marksmanship Unit trained Murdock, Writer, Bassham, and Etzel.



Margaret Murdock-Thompson, USA, stands on the victory podium at the 1976 Olympics with gold medallist Lanny Bassham, USA. Her silver medal made her the first woman ever to win an Olympic medal in shooting.



U. S. Army rifle shooter Lones Wigger is one of the all-time greats. He won two Olympic gold medals, two World Championships and dozens of other international medals.

The current Olympic program includes five different rifle events, two for women and three for men. The chart provides additional information about these Olympic target-shooting events.

Event	Type of Gun	Distance	Shooting Position	No. of Shots
Air Rifle Women	Air rifle	10 meters	Standing	40 shots, plus 10 shots in final
Air Rifle Men	Air rifle	10 meters	Standing	60 shots, plus 10 shots in final
Three Position Rifle Women	.22 caliber rim fire	50 meters	Prone, standing and kneeling	60 shots (20 in each position) plus 10 shots in final
Three Position Rifle Men	.22 caliber rim fire	50 meters	Prone, standing and kneeling	120 shots (40 in each position) plus 10 shots in final
Prone Rifle Men	.22 caliber rim fire	50 meters	Prone	60 shots, plus 10 shots in final

Target Shooting

The targets used throughout the history of marksmanship are graphic evidence of how the sport of target shooting developed. The earliest targets were cylinders or boxes with central marks that were used by archers. Live and later artificial pigeons were once placed on top of poles and used as targets. The earliest rifle targets were large wooden discs. Large steel plates were used for early rifle targets, which gave audible signals when hit. Paper targets came into use in the late 19th century and continue to be used in most ranges today. The most modern targets are electronic targets like those used in the Olympic games. Electronic targets have acoustical sensing systems that pinpoint and score the exact location of each shot and computer systems to calculate the scores and display instant results on electronic scoreboards.

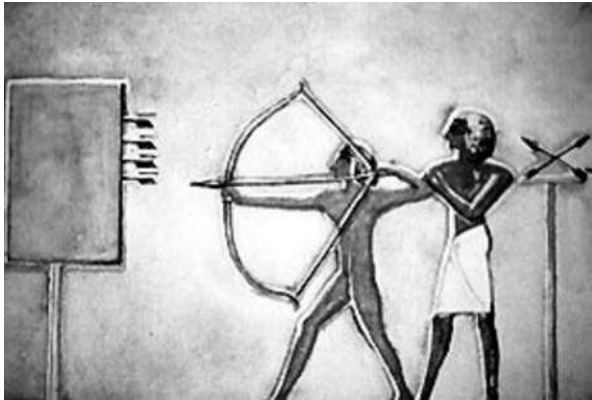

Targets used in Ancient Egypt 4,000 years ago were simple boxes or cylinders.



Rifle targets in 17th and 18th century Europe were large wooden discs that were fired at from distances of as much as 400 meters. The young boy was called a “Scheibentoni” or target marker.

The targets used today have concentric scoring rings. Shots that touch the central or inner ring score ten points. Shots that hit the next ring score nine points. Successively poorer shots score values down to one or even zero.

All target shooting events trace their origins to survival or martial skills that originally were intended to prepare men for battle. Target sports have a strong military heritage and target training is sometimes **practiced** as part of modern military or police training. Today, however, target rifle shooting is primarily practiced as a sport in the same way that basketball, swimming, running and skiing are sports. All sports have special qualities that make them unique. Target shooting participants need to know about some of its special qualities.

U.S. MARINE CORPS. JROTC
Category 5 – General Military Subjects
Skill 8 – Marksmanship



The most common targets today are paper targets with scoring rings that have values from one to ten. Shots hitting the center ring score ten points; shots hitting the next ring score nine points, etc.

*Target shooting is a sport that can be practiced by everyone. Successful target shooters are tall and short, stocky or thin. They must have reasonable flexibility and coordination, but no other special physical attributes are required. Shooters need to be able to see well, but it does not matter if their good vision is achieved by wearing eyeglasses or contact lenses. Indeed, the most important prerequisite for successful target shooting is an interest in the sport and a motivation to practice and learn. Success in shooting is **determined** by how hard one works, not by how much ability someone has.*

Target shooting is a sport where women and men compete equally. In shooting, neither sex has an advantage. In high school and college rifle competitions where men and women compete together, men and women win awards in direct proportion to their numbers.

Target shooting is a skill sport. All sports test different combinations of speed, strength, endurance and skill. Running is a test of speed or endurance. Weight lifting is a test of strength and skill. Figure skating is a test of strength and skill. Target sports are tests of skill. The special thing about skill sports is that no one is born with those skills they are developed through training.

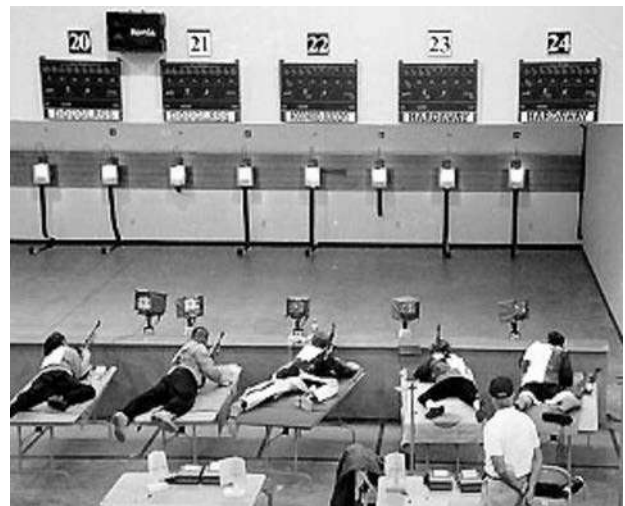

Electronic targets with acoustical-sensing systems that locate and score each shot are the most modern target system. With electronic targets, the shooter shoots into a target box that records the shot, displays its location and score on a monitor in front of the shooter and displays the score for spectators on a scoreboard above each shooter. The shooters in this photo are competing in the Georgia High School Rifle Championship on the range that was built to host the 1996 Olympic games in Atlanta.

Target shooting is a sport of control, discipline and concentration. It is not possible to handle guns safely or to advance in target shooting without having a great deal of self-discipline and control. It is not possible to fire consistent, accurate shots without developing great concentration skills. Target shooting does an exceptionally good job of teaching these and many other vital life skills.

Target shooting enjoys worldwide popularity. In the most recent Olympic Games, shooting ranked number three in the number of nations that qualified participating athletes. Only athletics (track & field) and swimming had more. Over 140 nations have organized target-shooting programs and belong to the International Shooting Sports Federation. Target shooting has more than 150 million participants throughout the world and is one of the most popular participation sports.

Target shooting is exciting and fun. The sport of shooting appeals to so many people precisely because hitting the center of a target on a consistent basis is extremely challenging. Trying to hit the center of difficult targets is a great test of mind and body. The thrill of firing a great shot that strikes the center of a target is as exciting as the thrill of successfully performing a difficult skill in any sport.

The type of rifle marksmanship that is taught and practiced in MCJROTC program is three-position rifle shooting that is primarily done with 4.5 mm (.177 cal.) air rifles with the targets placed at a distance of 10 meters. MCJROTC riflery was once done with .22 cal. rim fire rifles with the targets placed at a distance of 50 feet. A few programs still use .22 cal. rifles, but most MCJROTC cadets now practice and compete with sporter or precision class air rifles.



Cadets are shown firing at 10-meter targets in the standing position in a sporter class three-position air rifle competition.

Conclusion

Throughout history, marksmanship has been celebrated as a sport of skill. The best marksmen, since the Egyptian Pharaohs, to William Tell, to Annie Oakley, have always enjoyed a position of respect in society. Today, marksmanship is popular throughout the world, and is included in many Olympic events. Men and women compete equally in the sport of marksmanship, as neither has an advantage over the other. All it takes to become a skillful marksman is control, self-discipline, and the determination to succeed. ❖

Firearm Safety and Safe Range Operation

PURPOSE

This lesson introduces you to the main parts of the air rifle and the safest way in which to use it.

Introduction

The sport of target rifle shooting is one of the safest of all youth sports. In 104 years of Olympic shooting, there has never been an accidental injury involving a firearm. There are several thousand JROTC teams and junior clubs that practice and compete in position rifle shooting, with more than 100,000 participants throughout the United States, but these youth marksmanship activities have been accident free for many years.

Target shooting established its record as one of the safest of all sports because it is a sport where the **safety** of its participants can be assured when everyone follows basic safety rules. Target shooting is, in fact, a sport of control and discipline where everyone involved, including participants, instructors, coaches, and range officers, are expected to know and apply the sport's safety rules at all times.

Rules for Safe Gun Handling

There are three basic rules that are the foundation for the safe handling and shooting of all types of guns. These rules fully apply to the air rifles that are used in JROTC marksmanship programs. These fundamental safety rules focus

on three key parts of every gun that control when and where the gun can be fired. Those parts are the **muzzle**, **action**, and **trigger**. Everyone should know these basic parts of a gun, whether or not they ever will be involved in target shooting, so that they can practice the rules for safe gun handling any time they are in a situation where guns are present.

- *Muzzle.* The forward end of the barrel. The point where the pellet or projectile leaves the barrel when the gun is fired. A gun is aimed by pointing its muzzle at the target.
- *Action.* The working mechanism of the gun. Gun actions typically have a bolt or lever that is used to open and close the action so that the gun can be loaded and unloaded.
- *Trigger.* The trigger is part of the action or working mechanism of the gun. The trigger is a lever that projects out of the bottom of the gun. A trigger guard protects the trigger. After a gun is loaded and the action is closed, the gun is fired by pulling the trigger.

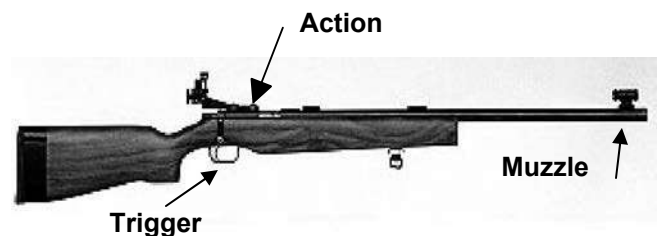

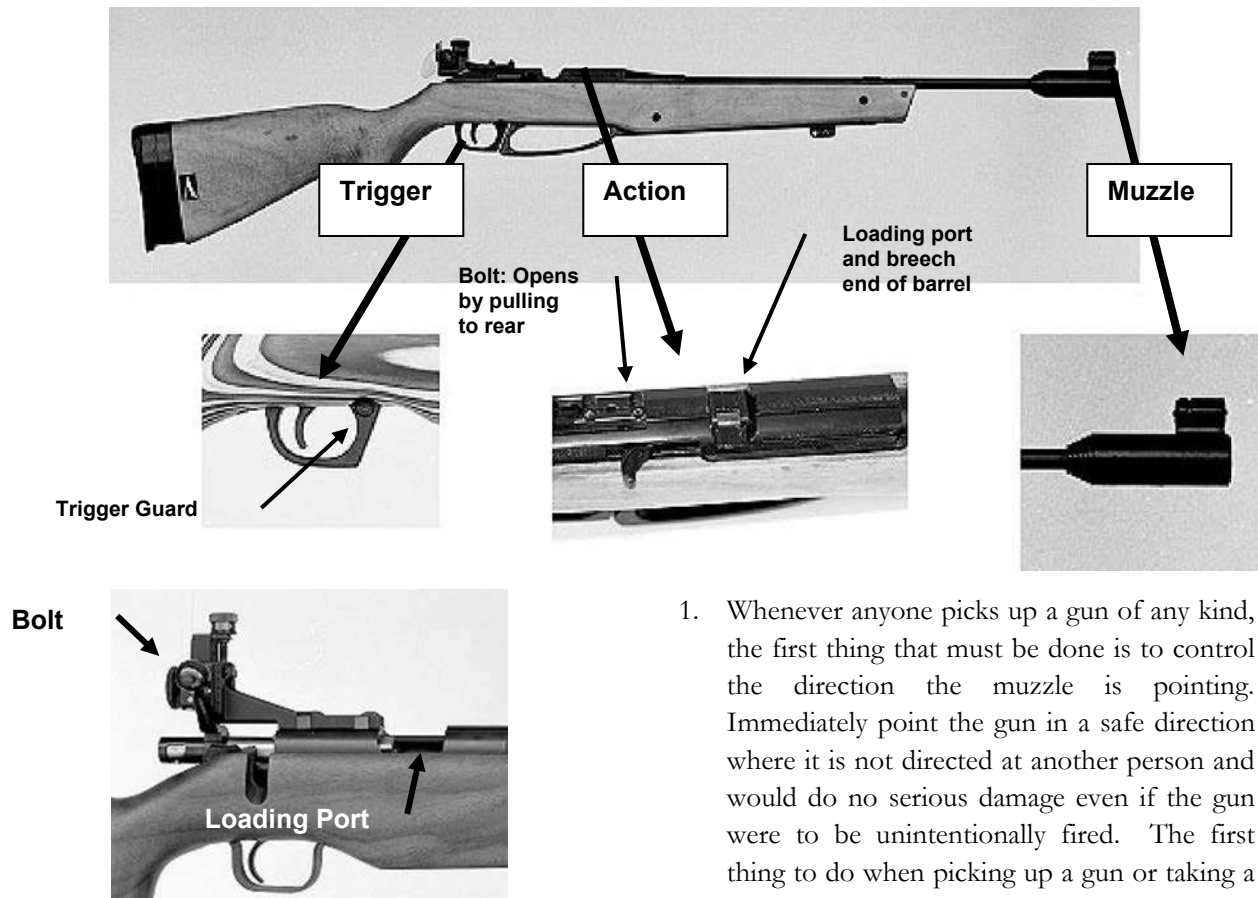

Some JROTC units still conduct rifle marksmanship training with .22 cal. small bore rifles like the one shown above. These rifles have bolt actions that are opened by lifting a bolt and pulling it to the rear.

The application of the rules for safe gun handling should follow a systematic sequence that is designed to assure that even if a gun were to be unintentionally fired, it would not cause personal injury or serious damage. Be sure to follow these steps:

1. Whenever anyone picks up a gun of any kind, the first thing that must be done is to control the direction the muzzle is pointing. Immediately point the gun in a safe direction where it is not directed at another person and would do no serious damage even if the gun were to be unintentionally fired. The first thing to do when picking up a gun or taking a gun from someone else is to point it away from other people in the area. The safest direction to point a gun is usually up or down. If a gun is on a range, the safest direction is to point it downrange toward the targets.
2. As soon as the gun muzzle is pointing in a safe direction, the second step is to check the action of the gun and to open it if it is not already open. Since the gun's action contains its firing mechanism, it cannot be fired unintentionally or accidentally if the action is open. All guns, except muzzle loading guns, have a bolt or lever on the action that is used to open the action. Be sure to learn where the bolt or cocking lever is on any gun you handle. With the action open, it is possible to visually check most guns to see whether the

gun is loaded and has a cartridge or pellet in the breech end (rear end) of the barrel. If the gun is loaded and it is possible to remove the cartridge, that must be done.

3. With the muzzle pointing in a safe direction and the action open so that the gun cannot be fired, the third safety precaution is to hold or carry the rifle so that the index finger is held outside of the trigger guard and not on the trigger itself. The trigger guard is a protective loop around the trigger. Its purpose is to protect the trigger from being pulled unintentionally. By keeping the index finger outside of the trigger guard, it is impossible to accidentally pull the trigger should the action somehow become closed.

Rules for Safe Gun Handling:

1. *Muzzle.* Always keep the gun muzzle pointed in a safe direction. The gun muzzle should never be pointed at other persons under any circumstances. On a range, the safest direction to point a gun muzzle is usually up or downrange toward the target
 2. *Rifle Action.* When handling any rifle or firearm, the action should be open. Gun actions must remain open except when the gun is on the firing line and the command to LOAD has been given. When shooting is finished or the rifle is placed down to take a break, the action must be open and unloaded, even when the gun is on the firing line. The gun action may be closed when it is placed in a gun case or storeroom, but must be opened as soon as it is picked up again.
 3. *Trigger.* Keep your finger off the trigger until after placing the gun in the shooting position and preparing to fire a shot. It is especially important to keep the finger outside of the trigger guard when loading the gun and placing it in the shooting position.
-

Shooting Ranges

Everyone who comes in contact with a gun needs to know the three basic rules for safe gun handling. Individuals who will use rifles in JROTC marksmanship or other target shooting activities also need to know and practice several additional rules regarding the safe operation of target shooting ranges.

To understand these safety rules it is first necessary to know something about how target ranges are designed. Study the diagram of the range so that you understand how the firing points and targets are positioned on a typical range. This diagram is for a 6-point range, but target ranges can have as few as four and as many as 100 or more firing points.



10-meter air rifle range target holders with targets placed at the proper heights for firing from the prone, kneeling and standing positions.



A range officer or instructor is in charge of the firing on every range.

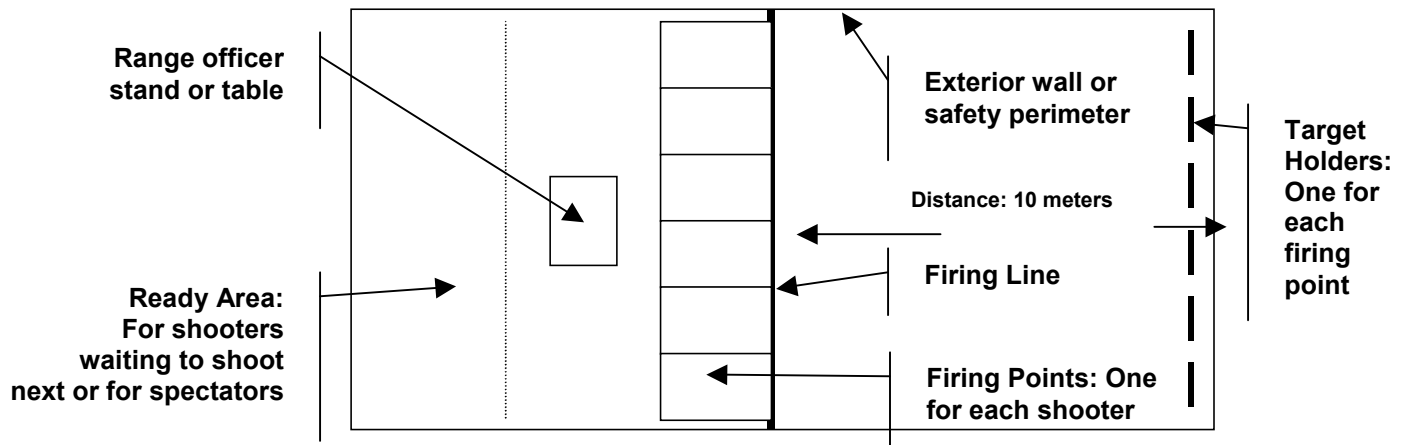

Each range has these primary features:

- *Safety Perimeter.* Ranges normally have an outside wall or some means of preventing unauthorized persons from entering the range area while firing takes place.
- *Target Holders.* At one end of the range, there are a series of target holders. The target holders normally have a metal sheet behind the targets that serves as a backstop to stop and collect all of the pellets that are fired at the targets. The target holders are designed so that targets can be hung on them at heights appropriate for the three shooting positions. Prone targets are hung low, standing targets are placed chest high and kneeling targets in between.
- *Firing Line.* At a distance of exactly 10 meters from the targets, a firing line is marked on the floor of the range. The firing line is normally a red or black painted stripe or line of tape that is two or three inches wide. All shooters must position themselves on their firing points so that no part of their feet or body touches the firing line.
- *Firing Points.* The firing line is broken into divisions called firing points. Firing points are rectangular spaces behind the firing line.
- *Range Officer.* Immediately behind the line of firing points, a table or stand for the range officer is located. The range officer is in charge of firing on the range and gives instructions to control shooting. Range officers use a standard series of range commands that control the conduct of any shooting activity.
- *Preparation Area.* Most ranges also have an area behind the firing line that is designated as a preparation or ready area. If there are spectators, this is the area where they should stand or sit. If there are other shooters who are waiting their turn to fire, this is the area where they should remain.

Firing Procedures and Commands

The range officer or instructor conducts the firing activity on the range. To begin a range activity, the range officer designates the shooters who will use the firing points and instructs them to move their equipment to the firing line and take their shooting positions. When rifles are brought to the range, their muzzles must be pointed up or down range, their actions must be open and the guns must be unloaded. After the shooters get into their shooting positions and are ready, the range officer gives a series of commands to start and stop firing.

- *Load.* No one may load any rifle until the range officer gives the command LOAD. Then the shooters may cock their rifles and insert a pellet or cartridge in them. It is a serious offense to load a rifle on a range before the command LOAD is given.
- *Start.* The next command tells the shooters that they can begin to aim and fire at their targets. No one may fire a shot until this command is given, even if the command LOAD has been given.
- *Stop.* When shooting is finished, the range officer commands STOP. If the command STOP is given during firing, every shooter must immediately stop firing, open the actions on their rifles and wait for further instructions. No one is authorized to fire a shot after the command STOP is given. The range officer or any other person on the range can command STOP if they become aware of a dangerous or unsafe condition.
- *Unload.* If anyone on a range has a loaded air rifle after the command STOP is given, they must notify the range officer by raising their hand or calling out “Loaded rifle.” The instructor will then give directions for

unloading any loaded rifles. Firing the rifle into an Air Rifle Discharge Container normally unloads loaded air rifles.



An air rifle discharge container is filled with paper or other material. When an air rifle remains loaded after the command STOP is given, the range officer will instruct that the rifle be unloaded by firing it into the container.

After firing is completed, the range officer will check each rifle to be sure it is unloaded and the action is open. When that check is completed, the range officer will instruct the shooters on the firing line to leave the firing line so the next group of shooters can move up to the firing line.

There are a few other rules that are used on shooting ranges to assure safety and orderly conduct of the shooting activity. Every shooter should be familiar with these rules and any special rules that apply to the range you are using.

- *Target.* Shoot only at the target designated for you. Be sure your target is properly placed in front of a safe backstop. Shooting at any object on a range besides your own target is strictly forbidden.
- *Loading.* Rifle muzzles must remain pointed down range or up whenever the rifle is cocked

and loaded. Special care must be taken to assure that a rifle muzzle is never allowed to point at a neighboring shooter or to any area behind the firing line during cocking and loading.

- *Going Down Range.* Whenever it is necessary for someone to go forward of the firing line to place or retrieve a target or for any other purpose, all rifle actions must be opened and rifles placed on the floor. No one should go forward of the firing line until authorized to do so by the range officer and no one should handle rifles while anyone is in front of the firing line.
- *Eye and Hearing Protection.* Wearing eye protection is recommended for air rifle shooting because of the remote possibility that a piece of a lead pellet could bounce back off of the backstop. Some shooters also wear hearing protection (ear plugs) while shooting air rifles, although this is usually done by shooters who primarily wish to reduce noise and improve their ability to concentrate.
- *Treat Every Rifle as if It Were Loaded.* This is the ultimate gun safety rule. Even if you are sure your rifle is unloaded and even if a range officer has checked it, treat the rifle as if it were loaded. Be sure it is never pointed at another person.

acquire the knowledge and skills to handle all guns safely. This knowledge will not only assure safety during rifle marksmanship training and competition, but it will ensure that any encounter a person has with a firearm is safe.

Learning and practicing these safety rules will help to ensure that target shooting remains one of the safest of all sports. ❖

Conclusion

The most important lesson that cadets who complete a basic marksmanship course will learn is how to be safe while handling any type of air rifle or firearm. By learning and following the rules of safe gun handling and the range safety rules for your range and by practicing those rules during target rifle practice, anyone who participates in a marksmanship training course will

Target Shooting Equipment and Its Operation

PURPOSE

This lesson introduces you to the function and proper operation of the marksmanship equipment.

Introduction

As we discussed in the previous lesson, before you can target shoot on a range, you must know how to handle guns safely. It is also important to know about the purpose and functioning of the air rifles and equipment that you will use. This chapter introduces you to the air rifles and equipment used in MCJROTC marksmanship training, and the basic principles of their operation.

The most common air rifle that is used in MCJROTC marksmanship training is the Daisy M853 pneumatic air rifle. Some MCJROTC units have Daisy M753 air rifles that are the same as the M853, except that they have an improved stock design and better sights. Some MCJROTC units now are acquiring newer Daisy M888 or Crosman M2000 CO₂ air rifles. Some units also have various models of precision air rifles. Most of those units, however, reserve these precision air rifles for members of their rifle team.

The projectiles used in air rifles are called pellets. They are made of soft lead, are 4.5 mm in diameter (.177 cal.), weigh about eight grains and possess about five foot pounds of energy when fired. Air rifle pellets are shaped like badminton shuttlecocks and have flat, solid heads and hollow skirts that help to stabilize them when they fly to the target. Air rifle pellets must be loaded so that

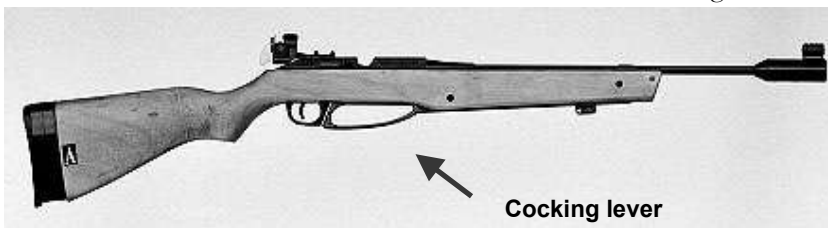

The Daisy M853 air rifle is a pneumatic air rifle. The cocking lever is opened and closed to compress air in a chamber. The compressed air is released by a valve when the shot is fired.

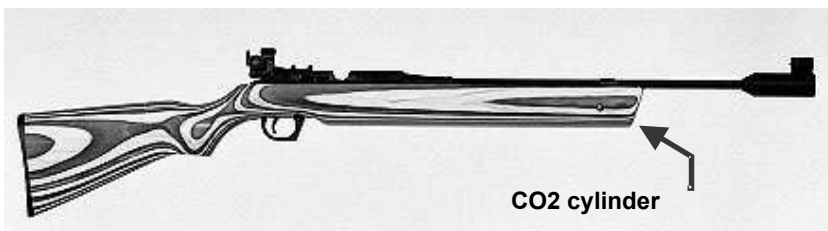

The Daisy M888 air rifle uses compressed carbon dioxide (CO₂) gas contained in a cylinder in the fore end of the stock to provide energy to fire the air rifle pellet.

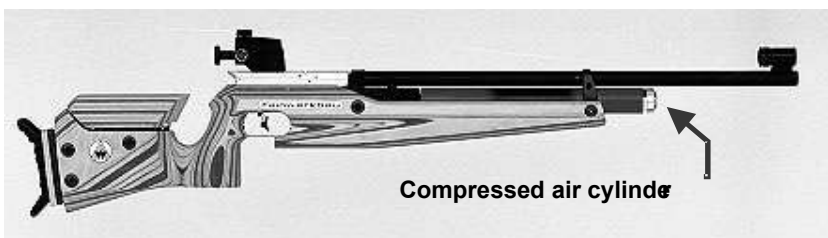

The Feinwerkbau P70 Junior is a typical precision class air rifle that uses compressed air contained in a cylinder in the fore end of the stock to provide energy to fire the pellet.

the head is pointed at the target and the skirt is directed to the rear.

How Air Guns Work

To fire their projectiles, air rifles utilize energy that is stored in the form of compressed gas. If the air rifle has a pneumatic system, energy is stored when the rifle is cocked. If the air rifle has a CO₂ or compressed air system, a pre-charged cylinder that contains stored energy in the form of compressed air or CO₂ gas is attached to the rifle. Air rifles are fired when the trigger mechanism is activated to open a valve that releases compressed gas into the barrel. This gas expands rapidly into the rear or breech end of the rifle's barrel and drives the projectile through the barrel to the target.

In contrast with air rifles, firearms utilize energy that is stored in the form of gunpowder that is contained in a cartridge. The cartridge also contains a bullet (projectile) and a primer. The cartridge is placed in a chamber at the breech end of the barrel. The cartridge is locked in place by closing the **action** or bolt. Firearms are fired

when the trigger mechanism is activated to release a firing pin that strikes and detonates the primer. The primer explosion then causes the powder to burn and create rapidly expanding gases that drive

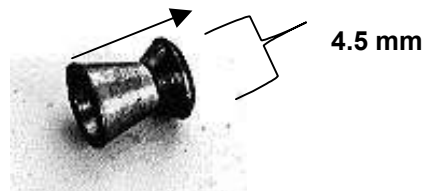

the projectile through the barrel to the target.



Air Rifle Pellets

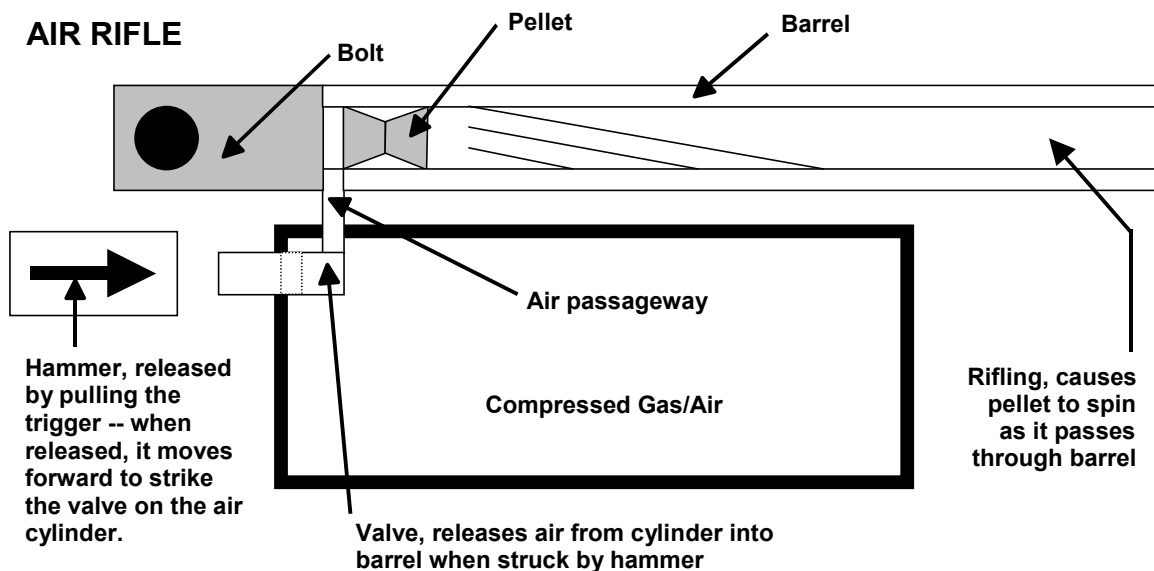

What Makes Rifles Accurate

When a rifle is fired at a target, two special features that are characteristic of rifles make it possible for the person who fires the rifle to direct the projectile at a precise point on the target. Those features are sights and rifling.

1. **Sights.** All rifles have sights. Target rifles have very precise, adjustable sights. Sights serve as a guidance system for the rifle that is controlled by the person who fires the rifle. The person who holds and fires the rifle looks through the rear and front sights to aim the rifle at the target. To hit the center of the target, the sights must be adjusted so that they point at exactly the same location on the target as the barrel points.
2. **Rifling.** All rifles also have rifling. Rifling is a pattern of flat spiral ridges inside the barrel that cause the pellet or projectile to spin when it leaves the barrel and flies through the air to the target. When a round or cylindrical object travels through air, it becomes unstable. To make that object stable and fly straight, it is necessary to make it spin. A Frisbee flies straight if it is spinning, but when it is not spinning fast enough, it wobbles and flies in

unpredictable directions. The same is true of the air rifle pellet.

Parts of an Air Rifle

During rifle marksmanship instruction, frequent reference will be made to the different parts of the rifle. In addition to the rifle's basic parts, the muzzle, action and trigger, it is important to know several other parts of the target air rifle. Learn to identify each of the parts identified on the chart below.

- *Bolt.* A handle or lever that is used to open and close the action of the rifle.
- *Loading Port.* The location where the pellet is loaded into the barrel. When the action is opened, the **loading port** is open so that a pellet may be placed in the breech end of the barrel.
- *Barrel.* A rifled tube that controls and directs the projectile when it is fired.
- *Cheek Piece.* The top part of the butt stock on which the shooter rests his/her cheek while looking through the sights to aim.

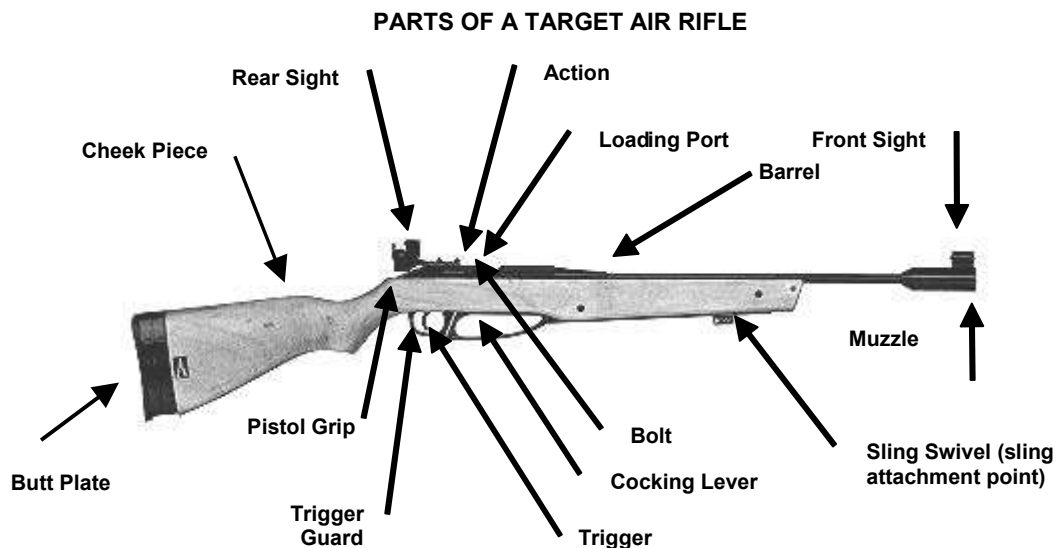

- *Cocking Lever.* On the Daisy M853, the **cocking lever** is opened and then closed so that a piston can compress air into the air cylinder. Compressed air or CO₂ air rifles do not have cocking levers.
- *Trigger Guard.* The trigger guard protects the trigger from catching on clothing or another object. This helps to prevent the trigger from being accidentally pulled.
- *Pistol Grip.* The curved portion of the stock behind the action and trigger. The trigger hand grasps the **pistol grip** and the index finger of that hand is then extended so that it can pull the trigger to fire the rifle.
- *Rear Sight.* The rear sight has an aiming aperture with a small hole that the shooter looks through during aiming. Rear sights used in target shooting have two adjustment knobs to make it possible for the shots fired to strike where they are aimed. Telescopic sights are not used in position rifle target shooting.
- *Front Sight.* The front sight has a ring or post insert that is used in aiming. The **front sight inserts** come in different sizes and can be changed so that the correct size front sight aperture is used.
- *Butt Plate.* The plate that covers the rear end of the stock. It is placed on the shooter's shoulder when holding the rifle in a shooting position to fire at a target. The butt plates on most air rifles used by MCJROTC units have spacers that can be removed or added to adjust the length of the stock. It is very important that each shooter use a stock that is the correct length.
- *Sling Attachment.* Target rifles have a **sling swivel** or sling attachment point where the sling that is permitted in prone and kneeling

positions is attached. The sling attachment point is normally adjustable forward or rearward on the fore end of the rifle.

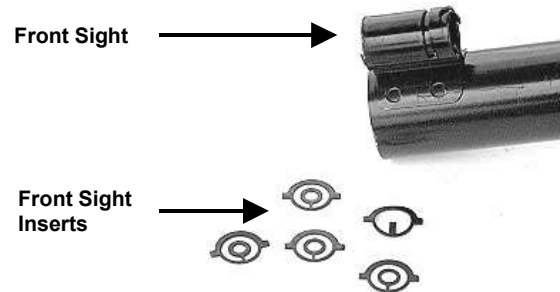
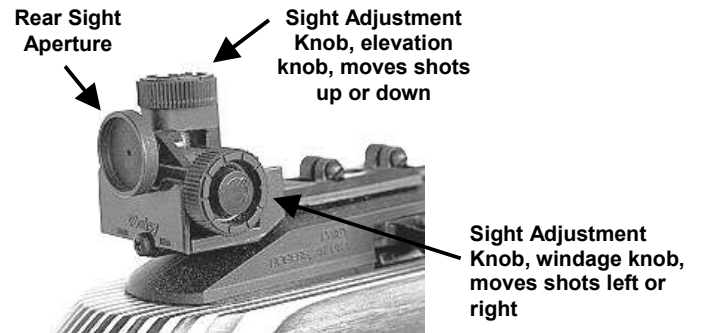

Target Shooting Equipment and Clothing

Only a few items of special target shooting equipment are needed for basic marksmanship training and the first levels of competition. The equipment that is used is needed to protect the shooter, to assist in holding the rifle steadier, or to make shooting more comfortable.

- *Sling.* A web (or leather) strap that attaches to the fore end of the rifle and has a loop that fits around the upper arm. The sling must be used in the prone and kneeling positions. When properly adjusted so that it is tight, the sling helps to hold the rifle steady.

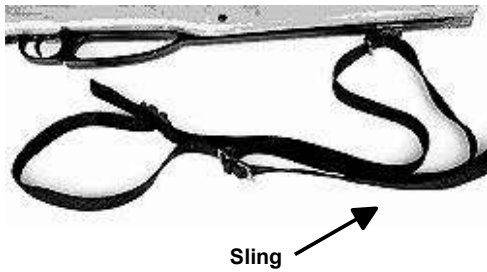

- *Glove.* Target shooters wear a glove on the hand that supports or holds the rifle. The glove protects the hand from the pressure of the sling when firing in prone and kneeling positions and allows the rifle to rest more comfortably on the hand while holding the rifle in standing position.



- *Kneeling Roll.* A cylindrical cushion that target shooting rules allow to be placed under the ankle when firing in the kneeling position. The **kneeling roll** provides stability and comfort to the body in the position.

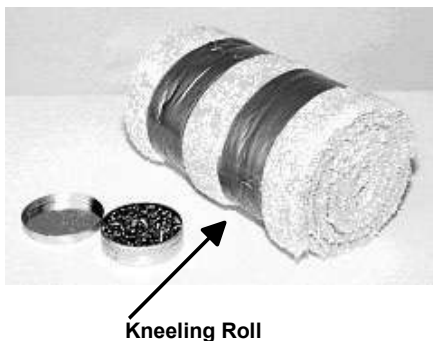

- *Shooting Mat.* A mat that target shooting rules allow shooters to lie on when firing from the prone position.

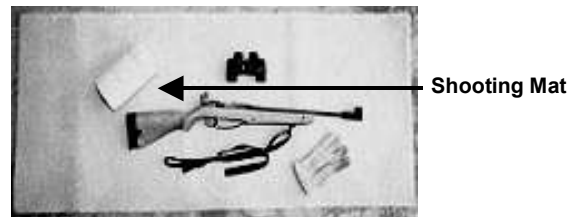

- *Rear Sight Blinder.* An attachment that is often used on the rear sight to block the view of the non-aiming eye. **Rear sight blinders** are usually homemade from cardboard or a strip of plastic cut from a milk carton.

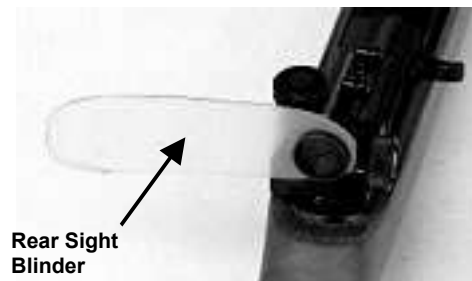

Personal Clothing and Equipment

Advanced competition shooters wear very specialized clothing such as shooting jackets, shooting pants and shooting boots. This special clothing is not necessary to practice the basic skills of target shooting. In fact, in sporter class air rifle competitions in which many JROTC rifle teams participate, this specialized equipment is not permitted. These items of personal clothing and

equipment are the minimum required for a safe, comfortable target shooting experience.

- *Eye Glasses or Safety Glasses.* One of the most important requirements for a target shooter is to be able to see well. Anyone who normally wears eyeglasses should wear them during shooting. Many champion shooters wear corrective lenses during shooting so there is absolutely no disadvantage to anyone who wears glasses. There is also an extremely remote chance of a piece of lead pellet fragmenting and bouncing back to the firing line. For this reason, it is highly recommended that all air rifle shooters wear either their personal eyeglasses or safety glasses to provide full protection for their eyes.



Safety glasses used for shooting should have a clear, distortion free area near the bridge for the nose. Target shooters look through this part of the lens when aiming at a target.

- *Hearing Protection.* Wearing earmuffs or earplugs is required when using firearms in order to protect against hearing loss caused by loud impulse sounds. Air rifles generate much less sound and hearing protection is not required to protect against noise generated by air rifles. Some air rifle shooters, nevertheless,

wear earplugs to reduce the sounds of air rifle firing and to help them concentrate.

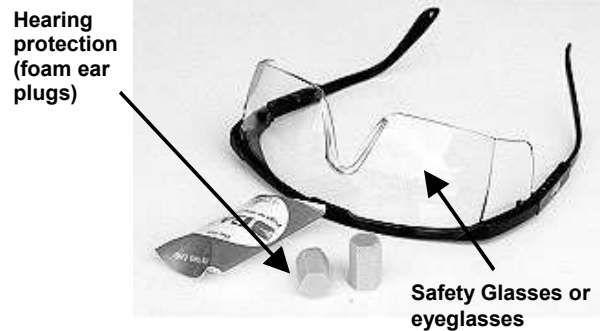

- *Clothing.* Almost any clothing may be worn during basic marksmanship instruction, although a sweatshirt or long-sleeved shirt is preferred. In sporter class air rifle competitions, a maximum of two sweatshirts and low-cut shoes only may be worn.



Sweatshirt or Long sleeved shirt

Loading and Firing an Air Rifle

To fire air rifles at targets, it is necessary for shooters to know how to cock, load, and fire them. Depending upon the type of air rifle used, there are three or four steps in doing this.

- *Step 1 – Open the Bolt.* The first step in loading and firing an air rifle is to open the bolt or loading port of the action. Opening the bolt cocks the trigger and firing mechanism.
- *Step 2 – Charge the Air Chamber.* This step is not necessary if a compressed air or CO₂ air rifle is used. With pneumatic air rifles like the Daisy M853, charge the air chamber by opening and fully extending the cocking lever, pause for a second to allow air to fully enter the chamber, and then close the cocking lever. Target air rifles like the M853 cannot be double-charged. When the air chamber is charged by working the cocking lever once, opening the cocking lever again will simply release the air from the chamber and the chamber must finish charging again by closing the cocking lever.
- *Step 3 – Load Pellet.* To load a pellet in the Daisy M853 or M888, place the pellet in the loading port. Then push the bolt forward to seat the pellet in the breech end of the barrel. With precision air rifles, the pellet is seated directly in the breech end of the barrel.
- *Step 4 – Release Trigger.* With the loaded rifle pointing at the target, the shot is fired by smoothly pressing the trigger to the rear until this releases the firing mechanism.
- *Dry Firing.* Dry firing is done by opening and closing the bolt or cocking mechanism without either charging the air chamber or loading a pellet. With a cocked, but unloaded air rifle, it is possible to simulate firing a shot. This simulation or dry firing is one of the best

ways to learn and practice proper shooting techniques.



←
Cock the pneumatic air rifle by opening and fully extending the cocking lever. Wait one second and then close the lever.

Conclusion

As soon as you know the essential details about the air rifle you will be using and how to load and fire it, you are ready to learn the first skills of target rifle marksmanship. ❖

To load the Daisy M853/M888, place a pellet in the loading port and close the bolt by pushing it forward.

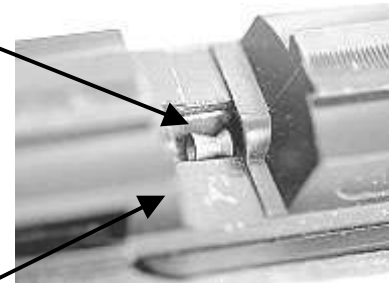

Complete loading by pushing bolt forward to seat pellet in breech

To load the precision air rifle, fully seat the pellet in the breech end of the barrel with the finger or thumb.

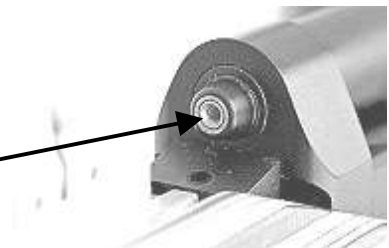

The Four Life Saving Steps

PURPOSE

This lesson introduces you to lifesaving techniques for emergency situations. Upon completion of this lesson, you will be able perform the four lifesaving techniques in saving someone's life.

Introduction

In emergencies, the people involved may find it difficult to remain calm and think clearly. In the midst of this confusion, one simple trick you can use to remind yourself of the first and most important problems to check for are the letters A-B-C. By determining which problems are the most important, you can then take the next steps to resolve the crisis.

- **A** stands for airway. Is the victim's airway blocked? If so, clear the airway.
- **B** stands for breathing. Is the victim breathing? If not, restore breathing.
- **C** stands for circulation. Is the victim's heart beating? If not, restore the heartbeat.

Cleaning the Airway of a Conscious Victim

Choking occurs when a person inhales something into the airway leading to the lungs, blocking off the airway, and preventing breathing. In many choking cases, people inhale particles of food while eating. In an accident, injured people

may choke on dirt, broken teeth, or dentures. The first procedure to learn is the Heimlich Maneuver.

Heimlich Maneuver

1. Stand behind the victim and wrap your arms around the victim's waist.
2. Make a fist with one hand and place the thumb side of the fist against the victim's abdomen slightly above the navel and well below the breastbone. Grasp the fist with the other hand.
3. Give 6 to 10 quick backward and upward thrusts; repeat this until the airway is clear.



For an exceptionally overweight person or pregnant woman, use the same procedure, except place the fist in the middle of the breastbone.

If you are the victim of an airway obstruction and no one is around to help, lean forward over a railing, sink, or the back of a chair

and thrust yourself down until you dislodge the obstruction.

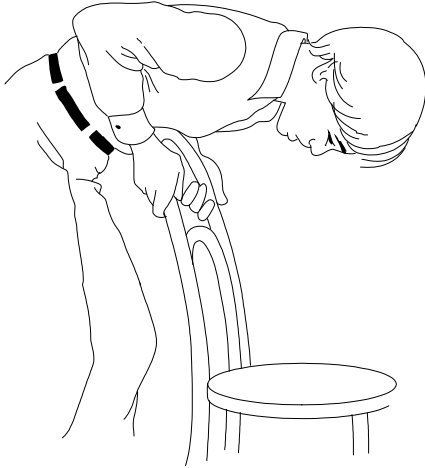

1. Kneel to the side of the victim's body. Locate the lower edge of the victim's ribs, and run the fingers up along the rib cage to the notch where the ribs meet the breastbone.
2. Place the heel of the hand two finger widths above the notch, and place the other hand over the first, interlocking the fingers.
3. Position your shoulders over your hands, and with the elbows locked, press down 1 ½ to 2 inches, 6 to 10 times.

Cleaning the Airway of an Unconscious Victim

If a person is unconscious and you know that individual has an obstructed airway, perform the following maneuver with the victim lying on his or her back:

1. Kneel astride the victim's thighs. Place the heel of one hand against the victim's abdomen, slightly above the navel, but well below the victim's breastbone, with your fingers pointing towards the victim's head.
2. Place your other hand on top of your first hand and press into the abdomen with a quick forward and upward thrust. Repeat this 6 to 10 times.
3. Open the victim's mouth and sweep out any foreign matter using a hooked finger. Be careful not to push anything down the throat.

For an obese individual or a woman in the advanced stages of pregnancy, use the following procedure:

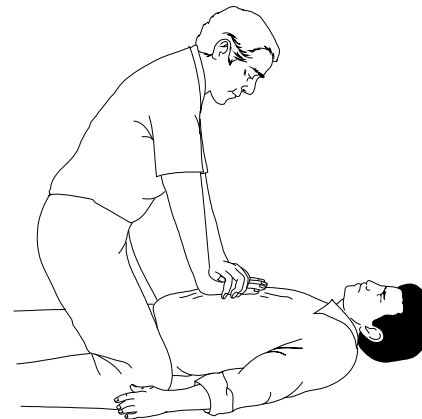

Restoring the Breathing

If you discover a victim who is not breathing, it is necessary to start breathing for the victim by forcing oxygen into his or her lungs as soon as possible. This process, called **rescue breathing** or mouth-to-mouth resuscitation, can prevent brain damage and death. Hopefully, applying this first aid step will start the victim breathing independently; but if not, continue it until a qualified person replaces you or medical help arrives. When you are giving mouth-to-mouth resuscitation to a victim, you are acting as a life-support system.

The following steps describe how to give mouth-to-mouth resuscitation to adults. Procedures that are different for infants and small children are italicized.

1. Roll the victim gently over if he or she is not already facing up. Open the mouth and check to see if it is clear. Using a hooked finger, sweep out anything you find in the mouth, being careful not to push anything down the throat.
2. Tilt the victim's head back sharply by pressing down on the forehead and lifting on the jaw. This straightens out the passageway to the victim's lungs. *For infants and small children, do not tilt the head back. Instead, place a finger under the chin and lift it slightly.*



3. Keeping the victim's head tilted sharply back, pinch the nose closed, cover the victim's mouth completely with your mouth, and give the victim two full breaths. *For infants and small children, do not pinch the nose closed. Instead, cover both the mouth and nose with your mouth and give small, slow, gentle breaths.* Each breath should last 1 to 1 ½ seconds. Pause between breaths to let the air come out of the victim and to breathe in yourself. If the victim's chest does not rise when you breathe into his

or her lungs, reposition the head slightly farther back and repeat the breaths. If the victim's chest still does not rise, perform abdominal thrusts to clear the airway as described in the previous section, "Clearing the Airway of an Unconscious Victim," then repeat the breaths.



4. After the two breaths, listen and feel for breathing by placing your cheek close to the victim's mouth. At the same time, check the victim's pulse by placing two fingers in the groove of the neck next to the Adam's apple. This is the location of the carotid artery, which normally produces a strong pulse.



5. If there is no pulse, start CPR immediately as described in the next section.
6. If there is a pulse but no breathing, continue mouth-to-mouth resuscitation at the rate of one breath every 5 seconds or 12 times a minute. *For infants and small children, give one slow breath every 3 seconds.*
7. If the victim starts to breathe, stop mouth-to-mouth resuscitation and let the victim breathe on his or her own. Check for other injuries, treat as required, and observe the victim closely until medical help arrives.

Cardiopulmonary Resuscitation (CPR)

As in mouth-to-mouth resuscitation, when you perform CPR, you are a life-support system for the victim. CPR is a first aid procedure performed to restore breathing and heartbeat. It is a combination of mouth-to-mouth resuscitation and a procedure known as closed chest heart massage. Mouth-to-mouth resuscitation supplies oxygen to the lungs, while the closed chest heart massage manually pumps blood through the victim's body, circulating it to the heart and brain. These actions help keep the heart and brain alive until the heartbeat is restored or medical help arrives.

CPR can be performed by a single rescuer or by more than one rescuer, since CPR can be tiring and is easier if two rescuers are available. The CPR procedures discussed in this lesson are for a single rescuer. Before beginning CPR, you should turn the victim face up, clear the airway, give two full breaths as described in mouth-to-mouth resuscitation, and check for a pulse. Only proceed if there is no pulse, and therefore, no heartbeat present.

Performing CPR on an Adult

1. With the middle and index fingers of the hand nearest the victim's legs, locate the lower edge of the rib cage on the side of the victim's chest closest to you.

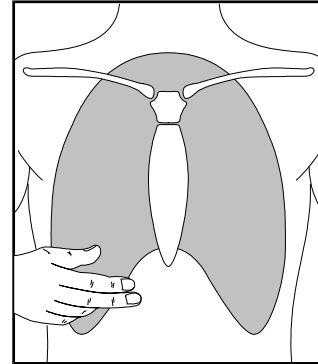

2. Slide your fingers up the edge of the rib cage to the notch at the lower end of the breastbone. Place your middle finger in the notch and the index finger next to it on the lower end of the breastbone.

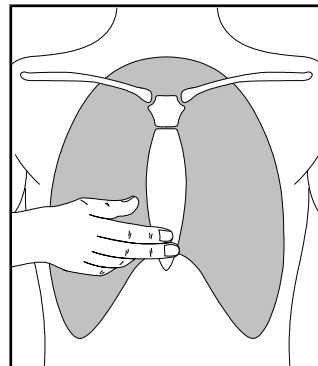

3. Place the heel of the hand nearest the victim's head on the breastbone next to the index finger of the hand used to find the notch.

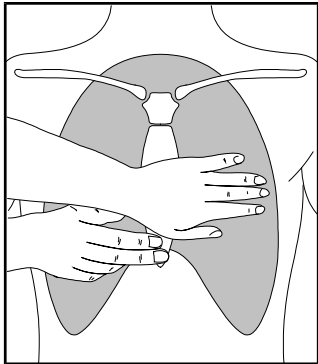

4. Place the heel of the hand used to find the notch directly on top of the heel of the other hand. Only let the heel of your hand touch the victim's chest; keep your fingers lifted off of the victim's chest. If you place your hands correctly, they will be positioned slightly above the lowest part of the breastbone, known as the xiphoid process. Avoid pressing on the xiphoid process because it breaks easily.

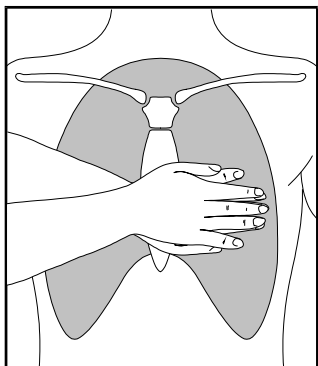

5. Position your shoulders over your hands, with elbows locked and arms straight.



6. Press down on the breastbone 1 ½ to 2 inches at a very quick, continuous rate. This squeezes the victim's heart against the spine and forces blood through the body.
7. While compressing, count aloud "one and two and three and four..." until you get to 15. It should take you about 10 seconds to do 15 compressions. Push down as you say the number and release the pressure as you say "and." Compress up and down smoothly without removing your hands from the chest.
8. After the fifteenth compression, give the victim two full breathes. Be sure to pinch the nose closed and tilt the victim's head back to straighten the airway. Then return to the chest compression.
9. When you complete four cycles of 15 chest compressions and two breathes, check for a pulse again. If there is no pulse, continue CPR.

Performing CPR on an Infant

1. Place your hand closest to the infant's head gently on the infant's forehead and leave it there throughout the procedure.
2. Place the middle and ring fingers of the hand nearest the infant's legs on the infant's

breastbone about one finger width below the infant's nipples.

3. Give five compressions with those two fingers at a rapid pace, pushing the chest down about ½ to 1 inch.
4. Follow the five compressions with one breath as described in the italicized text in step 3 of mouth-to-mouth resuscitation. Rapidly repeat the five compressions and one breath twenty times a minute until breathing and heartbeat resume.

Performing CPR on a Child

1. As with an adult, find the notched center of the child's ribcage with the hand closest to the child's legs. Measure two finger widths above the notch using the other hand, and then place the heel of the hand used to find the notch on the child's breastbone above the two fingers.
2. Place the hand that you used to measure two finger widths gently on the child's forehead and leave it there throughout the rest of the procedure.
3. Using the heel of your hand and keeping your fingers off of the child's chest, give five compressions 1 to 1 ½ inches deep, followed by one breath as described in the italicized text in step 3 of mouth-to-mouth resuscitation. Repeat this sequence twelve times a minute until breathing and heartbeat resume.

Heart Attacks

A **heart attack** occurs when the blood supply to part of the heart muscle is severely reduced or stopped. That happens when one of the coronary arteries (the arteries that supply blood to the heart muscle) is blocked by an

obstruction or a spasm. Common signs and symptoms so of a heart attack include:

- Uncomfortable pressure, fullness, squeezing, or pain in the center of the chest that lasts more than a few minutes or that goes away and comes back.
- Pain spreading to the shoulders, neck, or arms.
- Chest discomfort with lightheadedness, fainting, sweating, nausea, or shortness of breath.

When a person's heart stops beating, the victims is said to be in **cardiac arrest**. Cardiopulmonary resuscitations (CPR) can keep the individual alive. If a person has a heart attack, call EMS. Monitor the ABC's and give CPR as necessary.

Stroke

A **stroke** occurs when blood vessels that deliver oxygen-rich blood to the brain ruptures or when a blood clot forms and blocks the flow of blood in the brain. Common signs and symptoms of a stroke include:

- Paralysis on one side of the body
- Blurred or decreased vision, pupils of unequal size
- Problems speaking, slurred speech
- Difficulty breathing
- Mental confusion
- Dizziness or loss of balance
- Sudden, severe, or unexplained headache
- Loss of consciousness

If a person has a stroke, call EMS. Lay the victim down on one side and cover with

blanket. Monitor the ABC's and give CPR as necessary.

Automated External Defibrillators (AED)

Recently there has been a breakthrough in how Emergency Medical Technicians (EMTs) treat victims of sudden cardiac arrest. The **Automated External Defibrillator (AED)** is a device that uses a computer chip to analyze the heart rhythm and determines whether a **shock** is needed. This device allows victims suffering a sudden cardiac arrest a greatly improved chance of survival. Because of the ease of operation, people can be trained in AED use in a few hours and some say the techniques are easier to learn than CPR. Many AEDs offer voice prompts, which provide operators with clear and concise instructions. Most AEDs have only three buttons: On/Off, Analyze, and Shock. Many airlines have installed AEDs on all their planes and several cities are locating them in areas where there are large concentrations of people, such as malls, arenas, and stadiums.

Conclusion

This lesson presented the correct techniques for dealing with the most life-threatening conditions of an accident victim -- loss of breathing and heartbeat. Use the letters A-B-C to remind yourself of the first problems to check for on an injured person: **A**irway blocked, loss of **B**reathing, and lack of **C**irculation. Perform the **Heimlich Maneuver** to clear a victim's airway, mouth-to-mouth resuscitation to restore breathing, and CPR to restore circulation (heartbeat). For the best and safest results, take a class from a qualified instructor before performing mouth-to-mouth resuscitation and CPR on an injured person. ❖

Heat Injuries

PURPOSE

Participating in any vigorous outdoor exercise or activity on an extremely hot day can lead to serious injuries if you are not prepared. Knowing how to recognize the signs and symptoms of heat related injuries can help you prevent a life-threatening accident.

Introduction

For your body to work properly, its temperature must be normal, which is around 98° Fahrenheit. You risk health problems, and even death, if your body gets too cold or too hot.

Heat injuries can occur when people are exposed to high temperatures and high humidity. When it is hot, your body cools itself by perspiring -- sweat evaporates carrying heat away from your body. However, you risk heat injuries when you lose large amounts of water, salt, or both through perspiring, and do not replace the lost fluid, resulting in **dehydration**. You also risk injury in high humidity when sweat does not evaporate as rapidly as needed to keep the body cool, causing heat to build up. The body will then perspire even more in an attempt to cool itself, losing dangerous amounts of fluids in the process.

People who may be at risk of heat injuries include those who exercise or work outside in high temperatures and high humidity, or whose bodies do not regulate heat well, such as older people, overweight people, or babies.

Factors to Consider

When perspiring, the body can lose more than a quart of water per hour. Therefore, since the body depends on water to cool itself, you should drink plenty of water when working or playing in hot weather. Salt, which helps the body to retain water, is also lost through perspiring. In most cases, however, you do not need to consume extra salt because you obtain adequate amounts through a balanced diet. In fact, consuming salt during hot weather activities may pull water away from muscles and other tissues where it is needed and into your digestive tract.

In addition to water intake and diet, consider the type of clothing you wear in hot weather. Wear clothes that fit loosely but also protect the body from sunburn. Wear natural fabrics, like cotton, through which perspiration evaporates better. Some activities require extra clothing or equipment, like football or hiking with full camping gear. Soldiers may have problems acclimating to hot weather because of the type and amount of clothing and equipment they must wear. In all of these cases, protective gear and equipment may reduce **ventilation** needed to cool the body. So, ensure clothing or uniforms fit well but are not tight, and remove extra pieces of clothing and equipment as soon as they are no longer needed.

Types of Heat Injuries

Overheating of the body progresses through stages. At first, a person may suffer **heat cramps**. If the person ignores the symptoms and continues exercising, working, or playing in the heat, he or she may experience **heat exhaustion**.

If heat exhaustion is left untreated, heatstroke may follow and can be fatal.

Heat Cramps

Heat cramps are muscular pains and spasms caused by the loss of salt from the body through heavy perspiring. Other symptoms may include stomach cramps, wet skin, and extreme thirst. To treat heat cramps:

- Move the victim to a shady area or improvise shade.
- Loosen the victim's clothing.
- Give the victim large amounts of cool water slowly.
- Monitor the victim and give more water as needed.
- Seek medical aid if cramps continue.



Heat Exhaustion

When people work or exercise heavily in high temperatures or in a hot, humid place, the body loses fluids through heavy sweating. Heat exhaustion occurs when fluids are not adequately replaced or when sweat does not evaporate because of high humidity or too many layers of clothing, causing the body to sweat even more.

When the body loses a great amount of fluid, less blood flows to vital organs, resulting in a form of shock. The symptoms of heat exhaustion are:

- Heavy sweating
- Weakness or faintness
- Dizziness or drowsiness
- Cool, pale, moist skin
- Headaches
- Loss of appetite
- Heat cramps
- Nausea with or without vomiting
- Confusion
- Chills
- Rapid breathing and pulse
- Body temperature above normal but below 102° F.

Treat heat exhaustion as follows:

- Move the victim to a cool, shady area or improvise shade.
- Loosen the victim's clothing.
- Pour water on or apply cold, wet cloth to the skin. Fan the victim if it is a hot day.
- Have the victim slowly drink at least one quart of water.
- Elevate the victim's legs.
- Monitor the victim until symptoms are gone. If symptoms continue, seek medical aid.
- If possible, keep the victim from participating in heavy activity for the rest of the day.

Heatstroke

Heatstroke, also known as sunstroke, is a medical emergency that can be fatal if not treated as soon as possible. The victim's cooling mechanism stops working when the body perspires so much that no fluids remain to produce sweat. Since the body can no longer sweat and sweating is its defense against overheating, body temperature rises and skin becomes red and flushed. If body temperature rises high enough, brain damage and death can occur. Therefore, when you encounter a heatstroke victim, you must cool the victim as fast as possible.

Symptoms of heatstroke are:

- No sweating
- Hot, dry, red skin
- Headache, dizziness, nausea, and vomiting
- Fast, weak pulse and shallow respiration
- Seizures and mental confusion
- Unconsciousness or sudden collapse
- Very high body temperature.

Treat victims of heatstroke as follows:

- Move the victim to a cool, shady area or improvise shade.
- Loosen the victim's clothing. Remove any outer garments and protective clothing.
- Pour water on the victim or immerse in water, and fan the victim so sweat can evaporate. If you cannot immerse the victim, massage arms and legs with cool water.

- If the victim is conscious, have him or her slowly drink at least one quart of water.
- Seek medical aid and transport the victim to a medical facility as soon as possible. Perform any necessary life-saving measures.

Prevention of Heat Injuries

You can prevent heat injuries by taking just a few simple precautions and exercising a little common sense. If possible, limit your exposure to high temperatures and avoid working or exercising outside in hot, humid weather. During work or training periods, or in extremely hot climates, drink at least one quart of water every hour. Also, remember to dress for the hot weather and the activity being performed.

In the military or in the field, prevention of heat injuries is both an individual and leadership responsibility. Leaders should identify people who have a high risk of injury -- basic trainees, overweight individuals, and individuals who have symptoms of **fatigue** or a previous history of heat injury. If possible, leaders should schedule heavy or strenuous activities during cooler morning or evening hours.

Conclusion

As a cadet and a responsible individual, it is extremely important that you are aware of these types of heat injuries, their prevention, and their treatment. Remember: Anyone can be at risk of heat injuries.❖

Treatment of Cold Weather Injuries

PURPOSE

This lesson explains how you can prevent and, when required, treat cold weather injuries.

Introduction

Cold weather warrants special precautions for cadets who spend time outdoors. The possibility of exposure to cold weather injuries can make outdoor activity dangerous or at least uncomfortable for unprepared cadets. Because of this danger, it is important to be aware of the early warning signs and symptoms of cold weather exposure. It is also important to know how to prevent and treat cold weather injuries.

Humans are warm-blooded animals who maintain a relatively constant internal temperature, regardless of the environmental temperature. We do this by producing heat internally by metabolizing food and by adjusting the amount of heat we lose to the environment. Human cells, tissues, and organs operate efficiently only within narrow temperature limits. If a cadet's core temperature decreases by 2° F, he will feel cold. If his core temperature drops 7° F, the cadet's life may be put in jeopardy.

The human body is designed to live in tropical climates, so human heat loss mechanisms are highly developed. However, our insulation mechanisms are much less efficient. Cadets can live in a cold environment because of the intellectual responses that enable us to deal effectively with cold weather stress. Physical deficiencies are compensated by behavioral

responses such as eating and drinking and creating microclimates through the use of clothing, fire and shelter. However, as the body gets colder, intellectual responses diminish and this dangerously impairs a cadet's ability to react to the cold weather environment.

Shivering is usually the first sign of dangerous cold exposure, as the body tries to generate its own heat through uncontrolled muscle contraction. This should be the cadet's first warning to seek shelter.

Cold Weather Injuries

When the body is subjected to severely cold temperatures, the blood vessels constrict and body heat is gradually lost. As the body temperature drops, tissues are easily damaged or destroyed.

All cold weather injuries are similar, varying only in the degree of injury to tissues. The extent of the injury depends on such factors as wind speed, temperature, type and duration of exposure, and humidity. Fatigue, smoking, drugs, alcoholic beverages, emotional stress, **dehydration**, and the presence of other injuries intensify the harmful effects of the cold.

The most dangerous conditions that can result from cold weather exposure are **frostbite** and **hypothermia**. However, other conditions such as trench foot or immersion foot, and snow blindness can also occur when a cadet is exposed to a cold weather environment.

Hypothermia

Hypothermia is a condition in which a cadet's body temperature has become abnormally low. Signs of hypothermia occur when body temperature drops to a temperature of 95° F or lower. It can develop whenever heat loss exceeds heat gain and is as common during the wind, rain, and hail of summer as it is during winter. Immersion in cool to cold water is a significant cause of hypothermia. If body temperature drops as low as 80° F, death is likely to occur.

When exposed to cold temperatures, a cadet's body begins to lose heat faster than it can be produced. Prolonged exposure to cold weather will eventually use up the body's stored energy. Body temperature that is too low affects the brain, making the victim unable to think clearly or move well. This makes hypothermia particularly dangerous because a cadet may not know it is happening and won't be able to do anything about it.

The signs and symptoms of hypothermia change as body temperature falls. Mental functions tend to go first, and the cadet loses his ability to respond appropriately to the environment. Muscular functions deteriorate until he is too clumsy to walk or stand. Biochemical processes become slow and deficient as the body cools.

Early signs and symptoms of hypothermia can be difficult to recognize and may easily go undiagnosed. The cadet may appear not to feel well and his rescuer may assume that he is tired, not hypothermic. However, this is the stage in which successful rewarming is most possible.

Hypothermia in its later stages may be more obvious. The cadet could collapse, slur his words, or become semi-conscious, grossly uncoordinated, or unconscious and unresponsive.

This stage of hypothermia is easier to recognize, but is much harder to treat in the field.

Mild Hypothermia

In the early stages of hypothermia, a cadet will feel chilled. The skin may be numb with goose bumps and the cadet may have stiff and clumsy fingers. Shivering begins and mental deterioration starts to occur at the same time. Responses are slow and may be inappropriate, such as not changing into dry clothing, failing to wear a raincoat, jacket, or hat.

Moderate Hypothermia

As moderate hypothermia occurs, the cadet's body temperature will drop into the mid-nineties. The deterioration of muscular coordination is the most obvious sign. The cadet may stumble, walk slowly, lack energy, and become apathetic and lethargic. He may also talk less and become uncooperative and complaining. The cadet's responses to questions may be inappropriate. He may exhibit slurred speech and confusion about time or place.

As the cadet's body temperature approaches the low nineties, he will show a definite lack of gross muscular coordination. The cadet will stumble, fall, and be unable to use his hands. He may become cantankerous or forgetful and display inappropriate behavior. Shivering will stop.

Severe Hypothermia

When a cadet's body temperature drops below 90° F, his energy reserves will be depleted and obvious mental deterioration will be present. Other outward symptoms will be incoherence, disorientation, and irrationality. The cadet's exposed skin will appear very cold and may be blue.

If the cadet's core temperature falls into the mid-to-low eighties, severe muscular rigidity may occur. The cadet may become unconscious and exhibit dilated pupils. His pulse may be undetectable and he may appear to have stopped breathing or to have already died.

Prevention of Hypothermia

The best method for a cadet to prevent hypothermia is to be cognizant of the weather conditions and his surroundings. Dressing appropriately for cold weather conditions and for being in the field will help the cadet to stay warm and dry. Layering the cadet's clothing by wearing several layers of lighter clothing instead of one heavy layer allows the cadet to better regulate the amount of insulation covering his body. If the cadet becomes warm, he can take layers off and add some more clothing layers if he becomes cold.

Treatment for Mild to Moderate Hypothermia

A mildly hypothermic cadet may be successfully rewarmed in the field. In the absence of a serious underlying medical condition, the chances for successful rewarming are good. A cadet in early hypothermia may respond well to removal of the cold stress. While the air temperature cannot be changed, a cadet's wet clothing can be replaced with dry, the cadet can be protected from the wind, layers of blankets and clothing can be added for additional heat, hot liquids may be administered, and the cadet can be rewarmed with a source of external heat such as a fire. Warm fluids such as soup, tea, and hot chocolate can be given by mouth, if the person can hold the cup/bowl by himself.

Treatment for Severe Hypothermia

A cadet with severe hypothermia must be rewarmed in a hospital. The severely hypothermic cadet will produce little or no body heat and in the absence of external heat sources, may continue to

cool. A cold heart is susceptible to abnormal rhythms such as ventricular fibrillation, a random quivering of the heart that fails to pump blood and the jarring or bouncing a severely hypothermic cadet when transporting him from the field could trigger this rhythm. Evacuation of a severely hypothermic cadet from the field must occur simultaneously with attempts to prevent further cooling. If external heating is not applied to the cadet during transport, further cooling is almost certain. Monitor ABC's (airway, breathing, and circulation), as outlined in the previous lesson.

Frostbite

Frostbite occurs when ice crystals form in the skin or deeper tissues after exposure to a cold temperature, high altitude, or high-wind speed. The exposure time necessary to produce frostbite varies from a few minutes to several hours. The areas commonly affected are the face and extremities.

The symptoms of frostbite are progressive. Casualties generally incur this injury without being acutely aware of it. Initially, the affected skin reddens and there is an uncomfortable coldness. With continued heat loss, there is a numbness of the affected area because of reduced circulation. As ice crystals form, the frozen extremity appears white, yellow-white, or mottled blue-white, and is cold, hard, and insensitive to touch or pressure.

Frostbite is classified as **superficial** or deep, depending on the extent of tissue involvement. In superficial frostbite, the surface of the skin will feel hard, but the underlying tissue will be soft, allowing it to move over bony ridges. This is evidence that only the skin and the region just below it are involved. Deep frostbite reaches into the deep tissue layers. Ice crystals form in the

entire thickness or the extremity. The skin will not move over bony ridges and feels hard and solid.

Treatment for Frostbite

Taking the cadet indoors and placing the affected extremity under the rescuer's armpit, against the abdomen, or between the legs, can thaw superficial frostbite. Feet can be rewarmed by placing them in the armpit or against the abdomen of a buddy. Warm water immersion, skin-to-skin contact, or hot water bottles can also gradually rewarm superficial frostbite areas. Never rub a frostbite area.

Treatment for deep frostbite is best done in a hospital where close attention to the rapid rewarming process can be accomplished. The process requires rapid rewarming in water maintained at a constant temperature of between 100° to 108° F. Water colder than 100° F will not thaw frostbite rapidly enough and water hotter than 108° F may burn the cadet.

There is no danger of over thawing, but under thawing can leave tissue permanently damaged. A flush of pink indicates blood returning to the affected site. Rewarming frostbite is generally very painful and aspirin or ibuprofen is appropriate for pain relief. If hypothermia is present, it takes priority over frostbite in treatment.

After the affected area has been thawed, it must be air-dried and care must be taken not to rub it. Swelling will occur, along with the formation of blisters. Inserting gauze between the fingers or toes will keep these areas dry when the swelling occurs. Blisters may be drained with a sterile syringe and then dressed with aloe vera ointment. Once the tissue is thawed, it is extremely delicate and seemingly minor trauma can damage it.

Refreezing after thawing must be prevented. A freeze-thaw-freeze sequence will produce permanent tissue damage. The seriousness of frostbite injury is significantly increased if freeze-thaw-freeze occurs or if frostbite is accompanied by fracture or soft tissue injury.

Trench Foot/Immersion Foot

Immersion foot is a local, non-freezing cold injury that normally occurs in wet conditions. Immersion foot affects the extremities, including the hands, when a cadet is subject to limited motion while wearing water-soaked protective clothing, usually in temperatures of 30° to 40° F. However, immersion foot can also occur in temperatures above 40° F, if the extremities are subjected to constant wetting. An example of contracting immersion foot in warmer temperatures could be while sea kayaking. At least 12 hours' exposure to cold, wet conditions is necessary to produce the injury. Immersion foot has been contracted using hip waders and vapor barrier boots. Dry socks and feet provide total protection.

When cold, wet conditions constrict blood vessels over a long period of time, immersion foot occurs. Reduced blood flow to an extremity deprives cells of needed oxygen and nutrients. As a result, permanent muscle and nerve damage may occur. The extremity appears cold, swollen, and mottled and may look shiny. The cadet who has contracted immersion foot may describe the extremity as feeling wooden.

When the extremity rewarms, the skin becomes warm, dry, and red. The injury will be painful and the injured area may itch, tingle, and exhibit increased sensitivity to cold. Due to possible nerve damage, the itch, tingle, and

increased sensitivity to cold may become permanent sensations. In extreme cases, development of blisters, ulcers, and gangrene is possible. Loss of a foot or lower leg is also possible. The recovery period can last for weeks.

Prevention of Trench Foot/Immersion Foot

To prevent immersion foot, cadets should rotate their socks as often as possible to keep their feet dry, and wear a pair of cotton and a pair of wool socks to increase insulation and take the perspiration away from their feet. While working in conditions that could cause immersion foot, cadets should check their feet daily and sleep with feet warm and dry. If you choose to wear rubberized boots, remember they do not allow for ventilation and you will need to change your socks several times a day. Also, you may want to get some felt inserts for insulation.

Treatment of Trench Foot/Immersion Foot

Warm the affected extremity at room temperature. In serious cases swelling, pain, and blister formation will prevent walking. In most cases the extremity will be sore. Avoid walking on injured feet, and elevate the feet to reduce the swelling. Bed rest, along with avoiding trauma, is necessary until the injury heals.

Snow Blindness

Inflammation of the eye is caused by exposure to reflected ultraviolet rays when the sun is shining brightly on an expanse of snow. The symptoms of snow blindness can occur as much as 8 to 12 hours after exposure. Additional symptoms include the eyes feeling dry and irritated, and then feeling as if they are full of sand. Eye movement or blinking becomes extremely painful, exposure to light hurts the eyes,

and the eyelids tend to swell, eye redness, and excessive tearing.

Prevention of Snow Blindness

Wear good sunglasses or goggles with side shields. Eye protection from sun is just as necessary on cloudy or overcast days as it is in full sunlight when you are on snow. Snow blindness can even occur during a snowstorm if the cloud cover is thin.

Conclusion

Cold weather is a hostile environment that must be carefully planned for to prevent debilitating injuries. Wearing proper clothing, layering your clothing, and being aware of the conditions in which you will be exposed, are very important in surviving in a cold weather environment. Along with knowing your surroundings and dressing appropriately for cold weather conditions, a cadet also needs to know the additional measures to take to prevent cold weather injuries, and how to treat them if they do occur. Cold weather injuries can be very serious if the proper precautions are not taken. However, by paying attention to the information in this lesson, a cadet can spend enjoyable and constructive time in a cold weather environment, and minimize his chances of discomfort or injury.

❖

