

Layers of the Earth

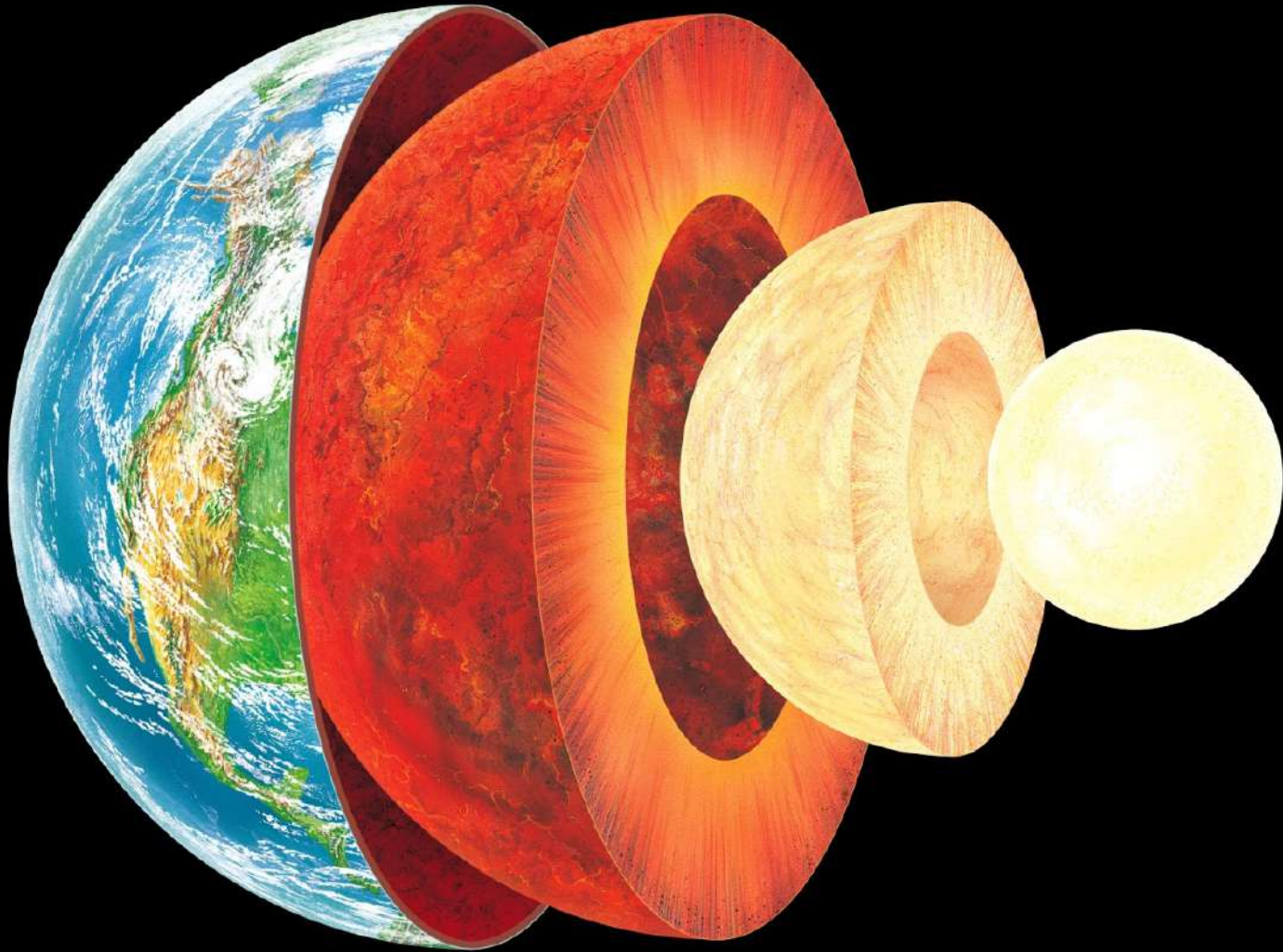

Watch the movie trailer for Journey to the Center of the Earth. Identify characteristics that you think are true and those you think are not true. Be prepared to share.

<https://www.youtube.com/watch?v=rQx2wLyagk4>

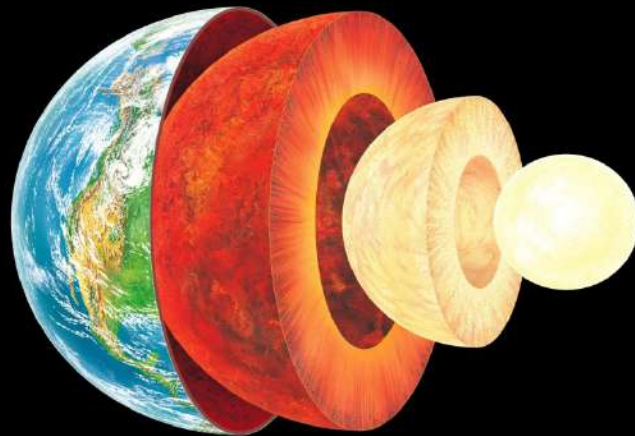

Essential Question:

How are layers of the Earth different from one another?

Standard:

S6E5a. Compare and contrast the Earth's crust, mantle, and core including temperature, density, and composition.

The Earth is made up of 3 main layers:

Crust

Mantle

Core

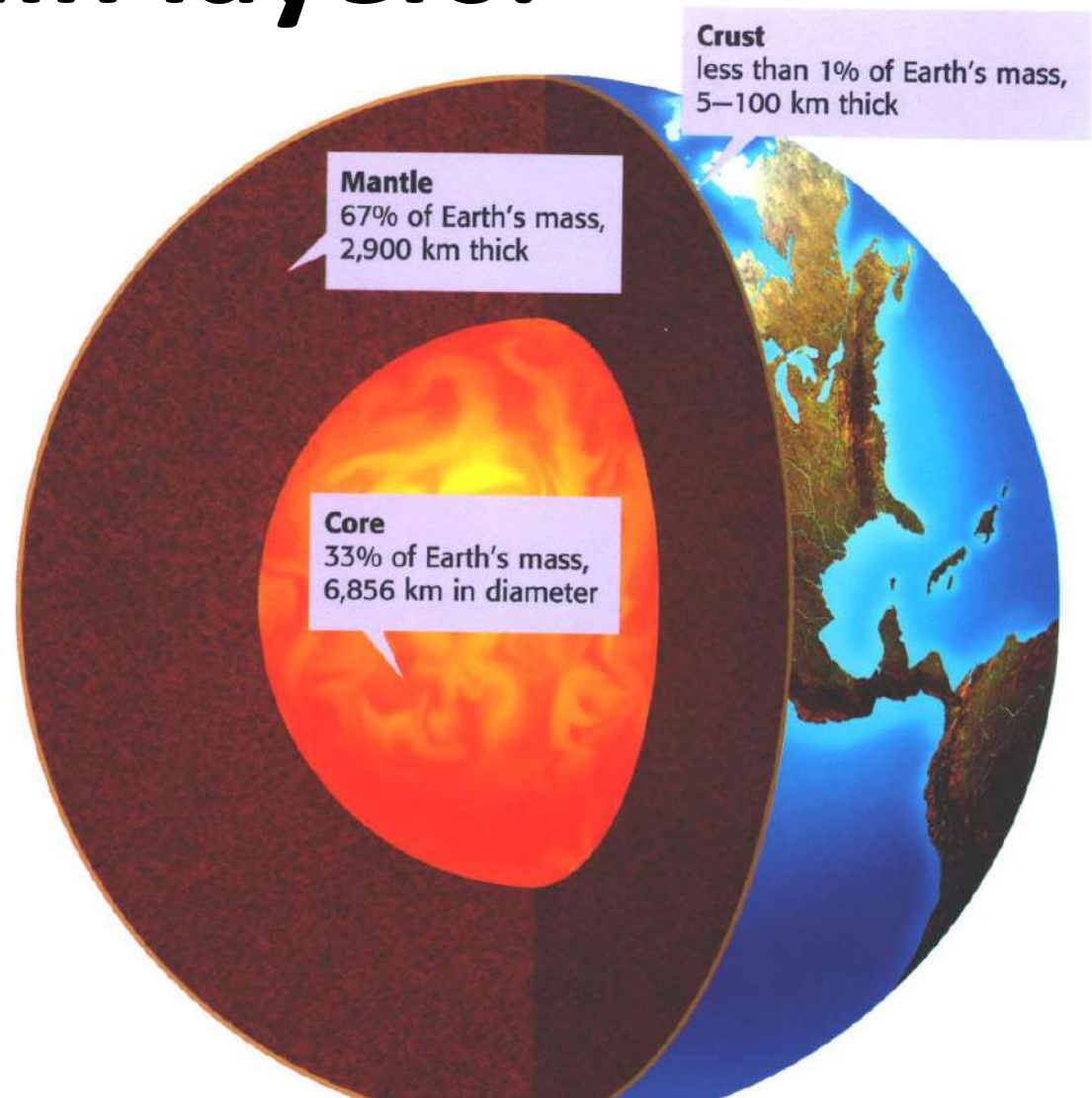

Think of the layers of the Earth like the layers of a cake.

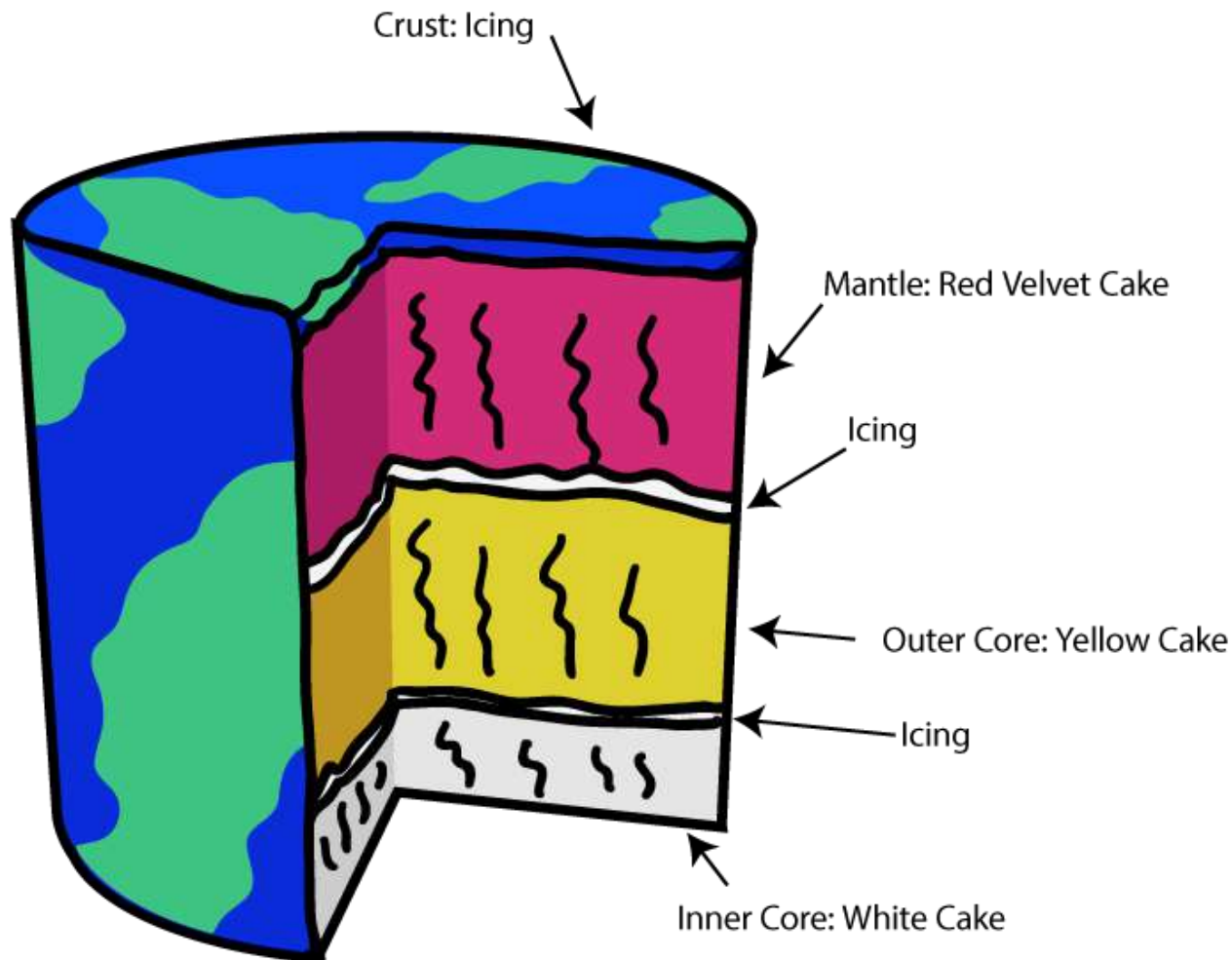

Use the Layers of the Earth Foldable to take notes

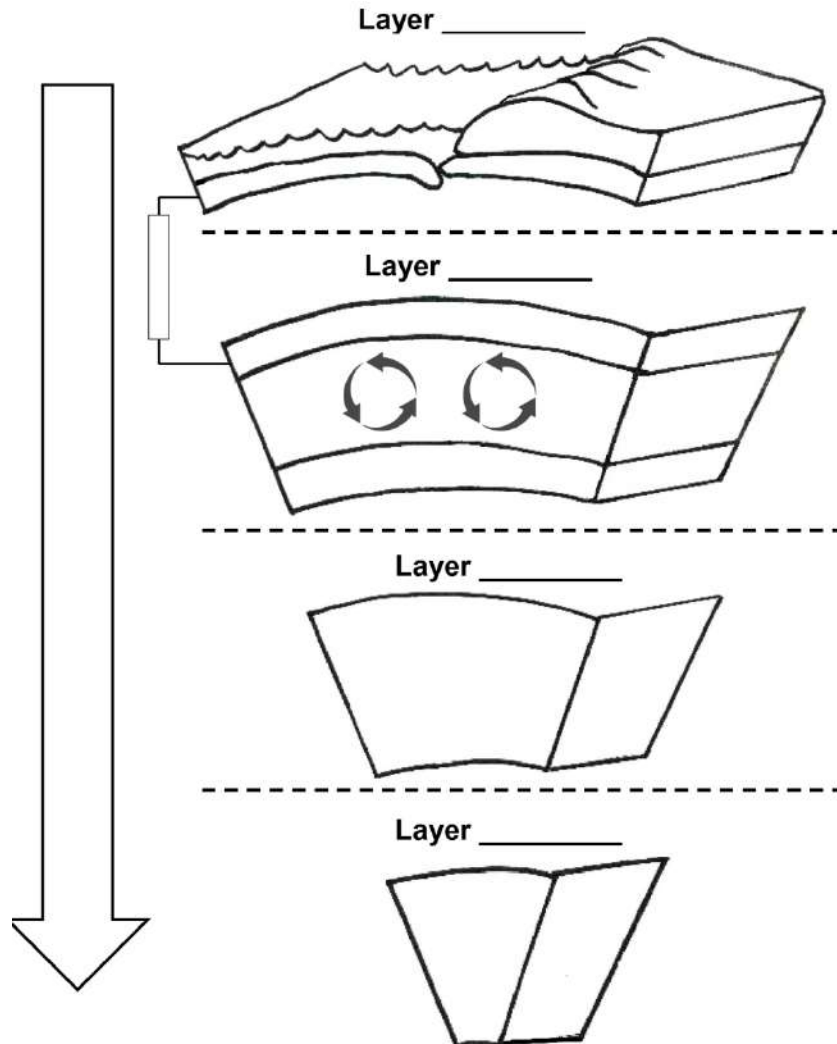

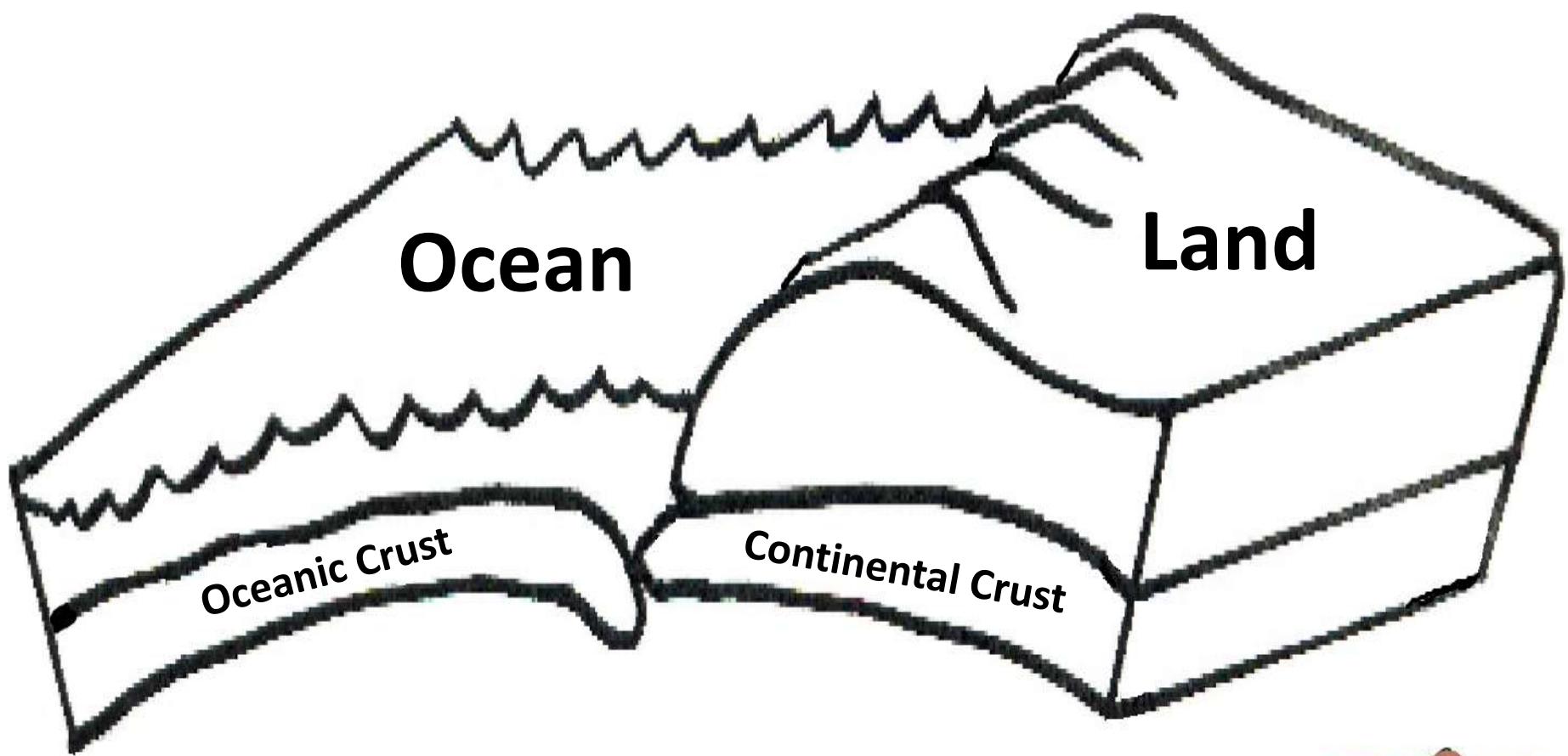

Crust

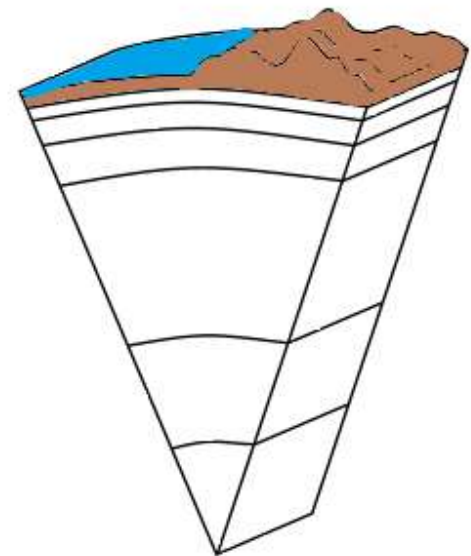

Crust

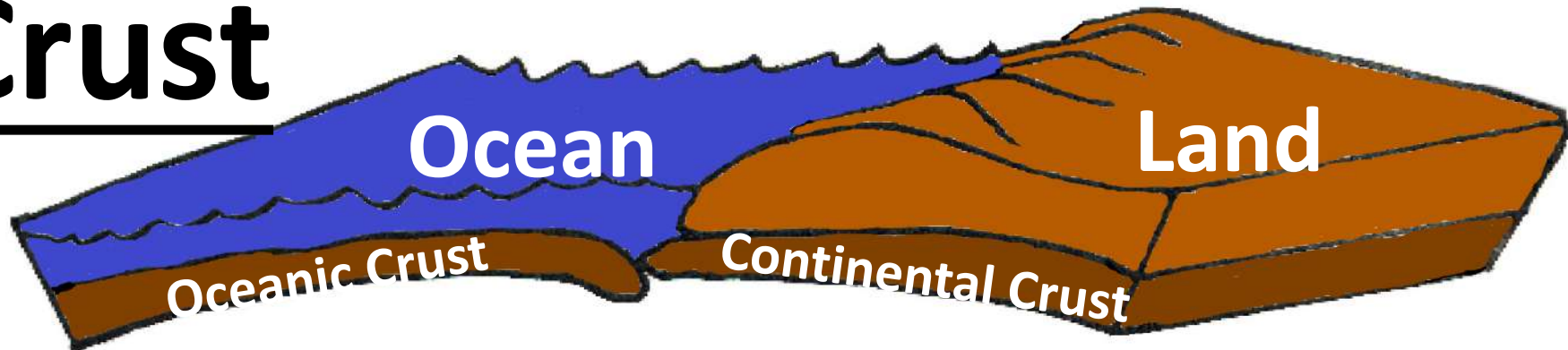

- **Thinnest layer of the Earth that ranges from only 2 miles in some areas of the ocean floor to 75 miles deep under mountains**
- **Made up of large amounts of silicon and aluminum**
- **Two types of crust: oceanic crust and continental crust**
- **Composed of plates on which the continents and oceans rest**
- **The lithosphere (crust and upper mantle) is divided into separate plates which move very slowly in response to the “convecting” part of the mantle.**

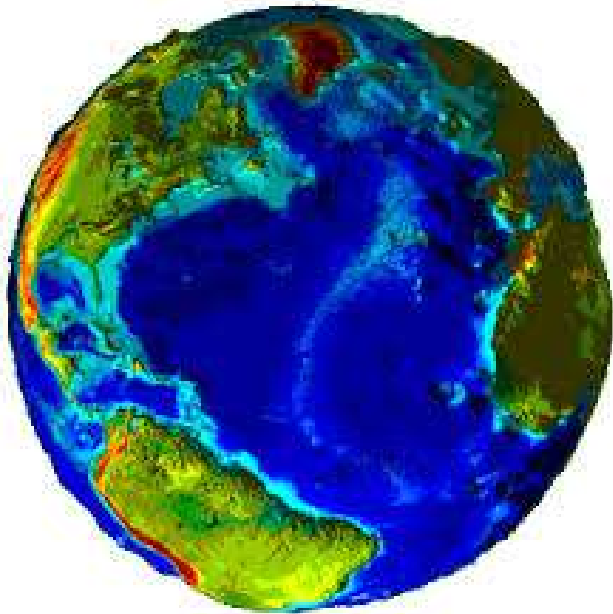

The Earth's crust is like the skin of an apple. Why this statement is true. Next, come up with another example.

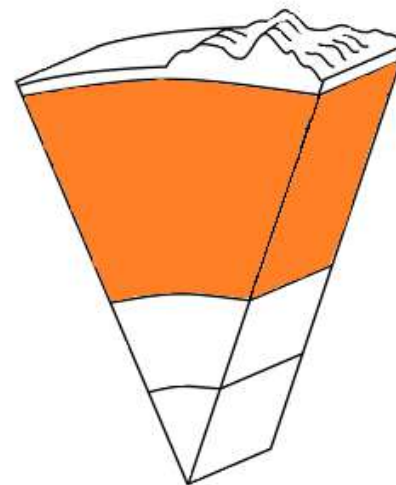
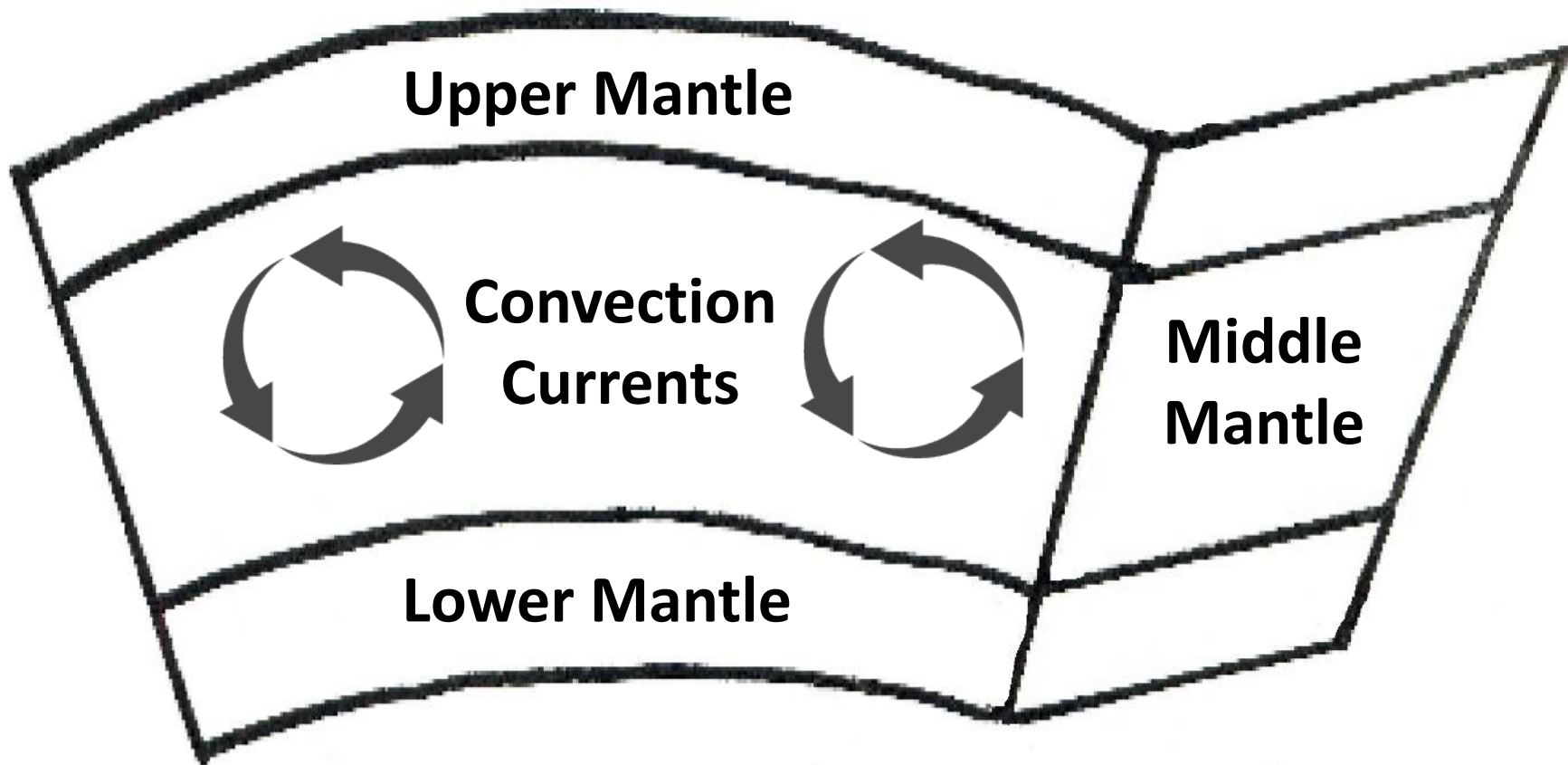

Mantle

Mantle

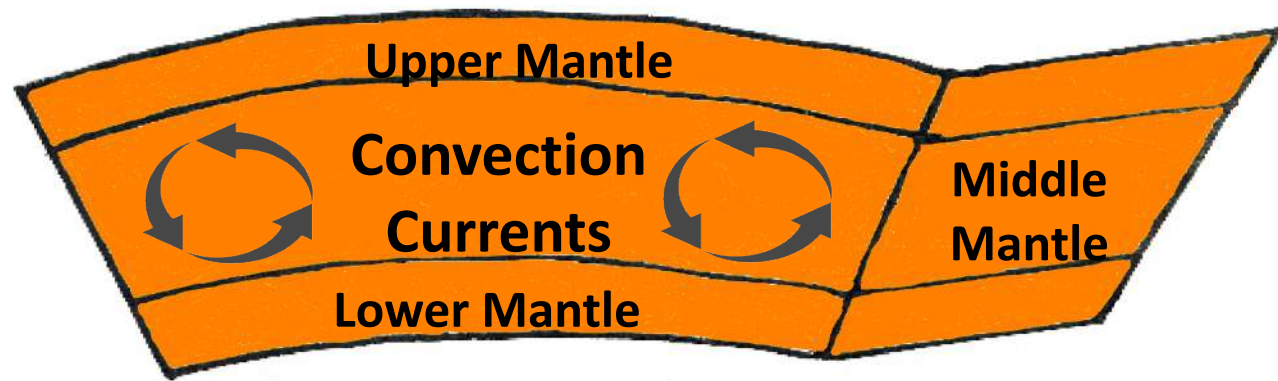

- Solid but capable of flow (like hot asphalt or fudge)
- Thickest layer of the Earth (making up 70% of the Earth's mass)
- The hot material (magma) in the mantle rises to the top of the mantle, cools, then sinks, reheats, and rises again. These convection currents cause changes in the Earth's surface
- Layer of the Mantle (asthenosphere) that consists of hot rock of tar-like consistency, which slowly moves

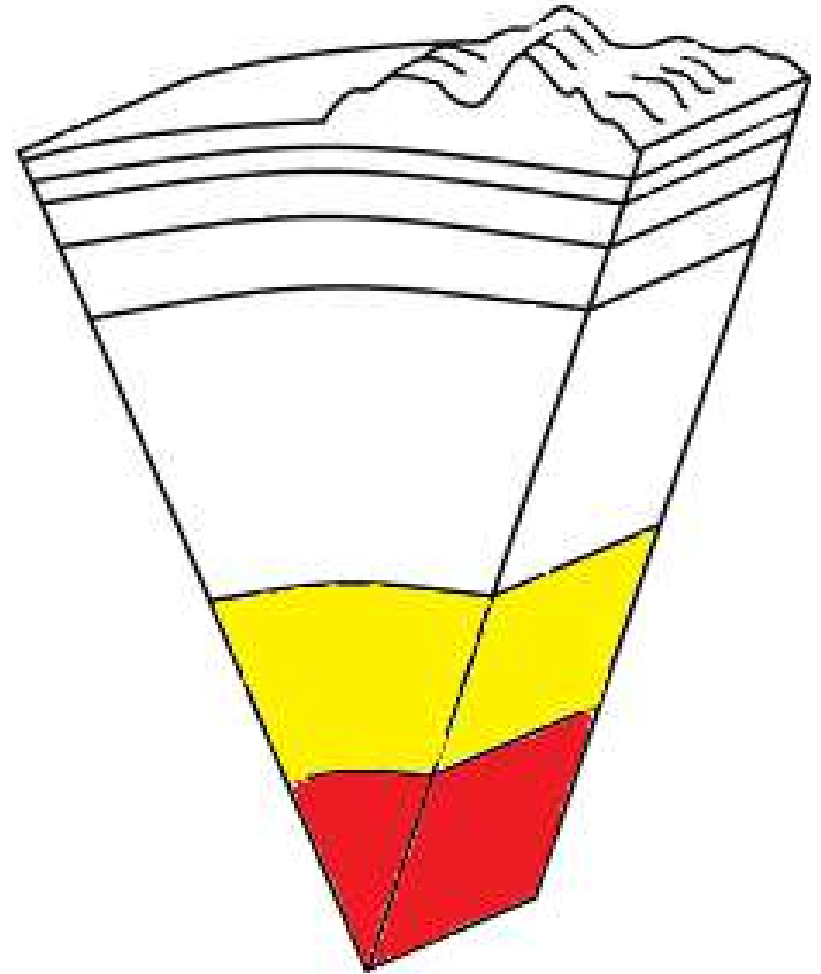
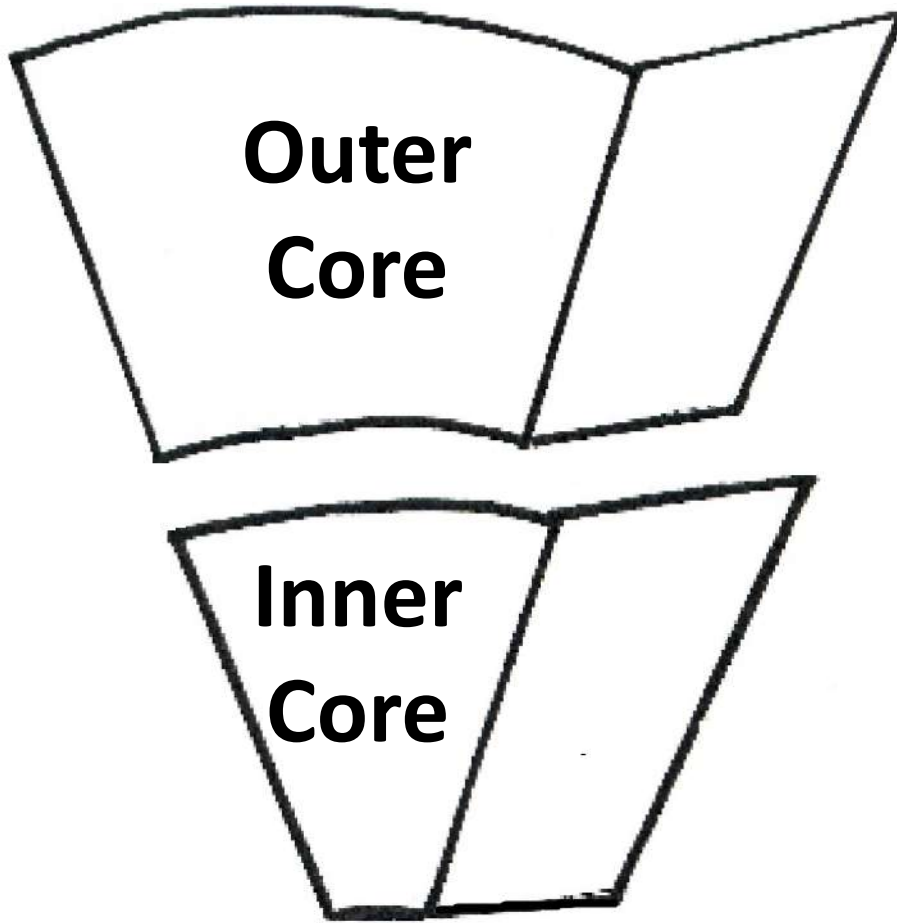

Core

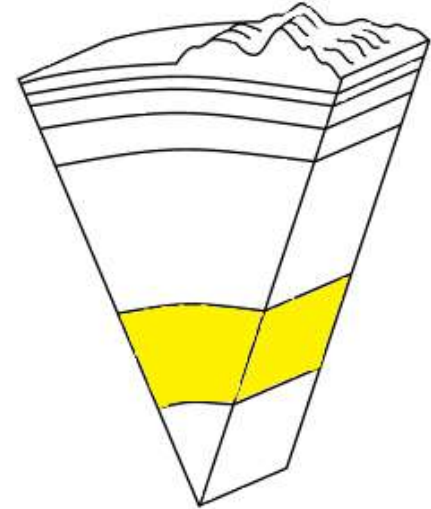
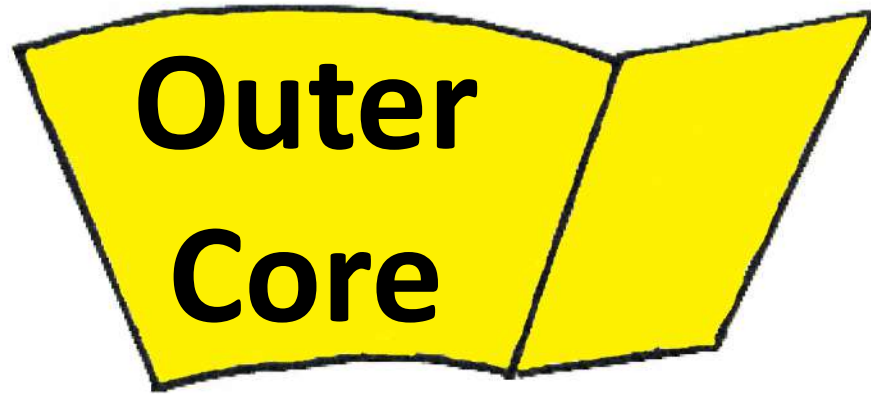

- **Molten (liquid) metal that is about 4,700°C (8,500°F)**
- **Located about 1,800 miles beneath the crust and is about 1,400 miles thick**
- **Composed of the melted metals nickel and iron**

Inner Core

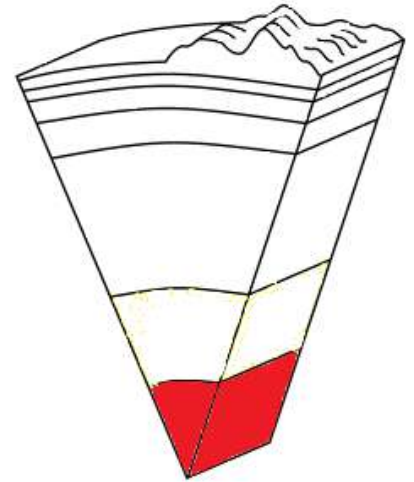
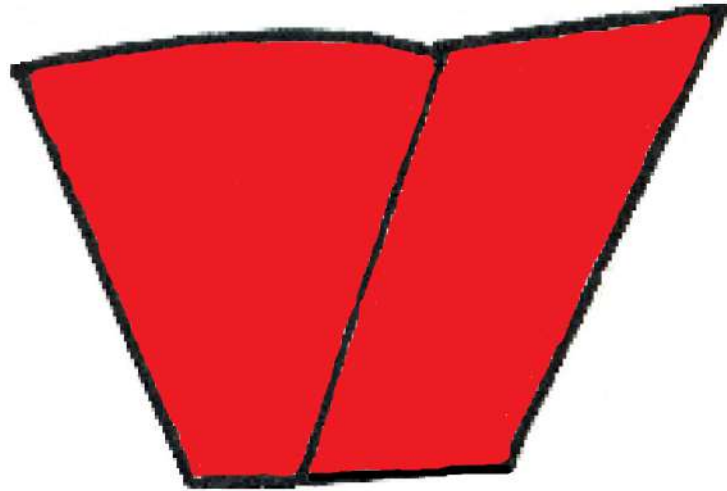

- Solid sphere composed mostly of iron
- It is believed to be as hot as $6,650^{\circ}\text{C}$ ($12,000^{\circ}\text{F}$)
- Heat in the core is probably generated by the radioactive decay of uranium and other elements
- It is solid because of the pressure from the outer core, mantle, and crust compressing it tremendously

Related videos

<https://www.youtube.com/watch?v=zocutif0cQY&list=PLqVMbeJgOJmZwreZPqGb-ovXAFSJD9eVO>

https://www.youtube.com/watch?v=Kg_UBLFUpYQ&t=184s

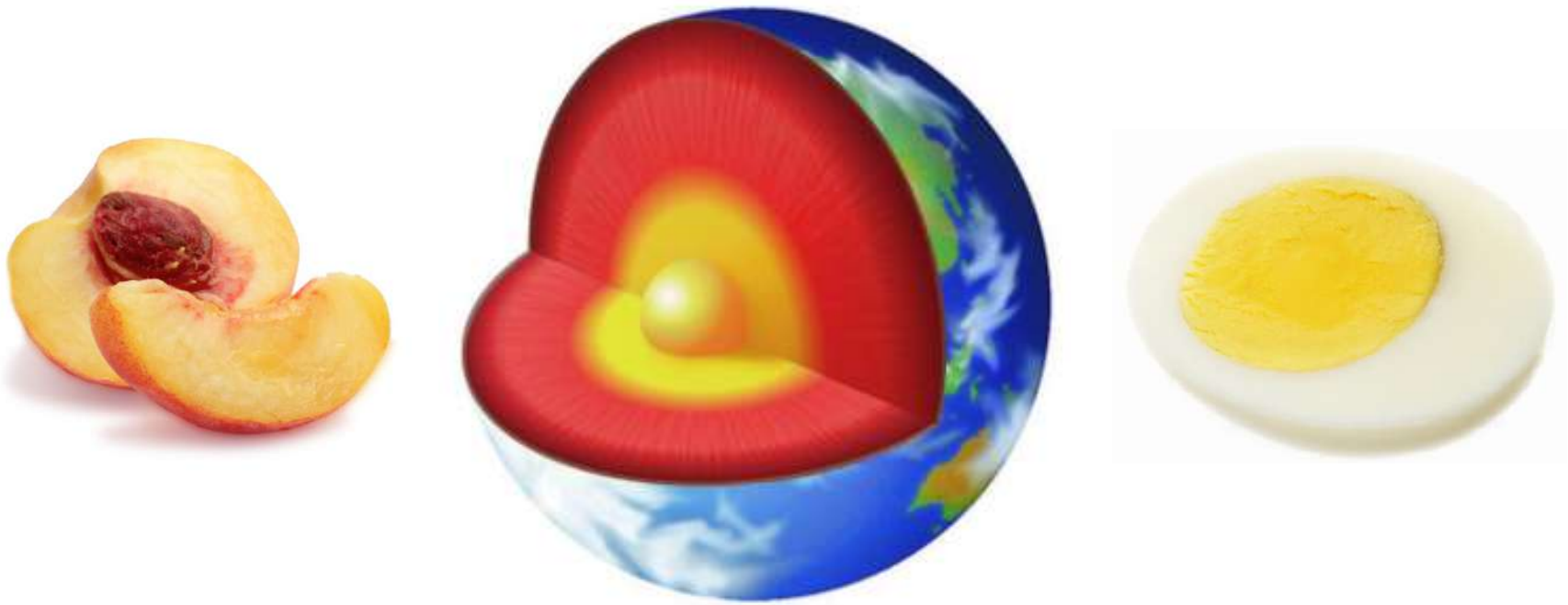

The Earth is like a peach or a boiled egg. Turn to a seat partner and discuss these analogies. Come up with another analogy and be prepared to share.

Crust



Mantle

**Outer Core
Liquid**

**Lithosphere – Crust and
Upper Layer of the
Mantle**

**Layer of the Mantle
(asthenosphere) that
consists of hot rock of
tar-like consistency,
which slowly moves**

**Inner Core
Solid**

Outer core
2,200 km

Inner core
1,228 km

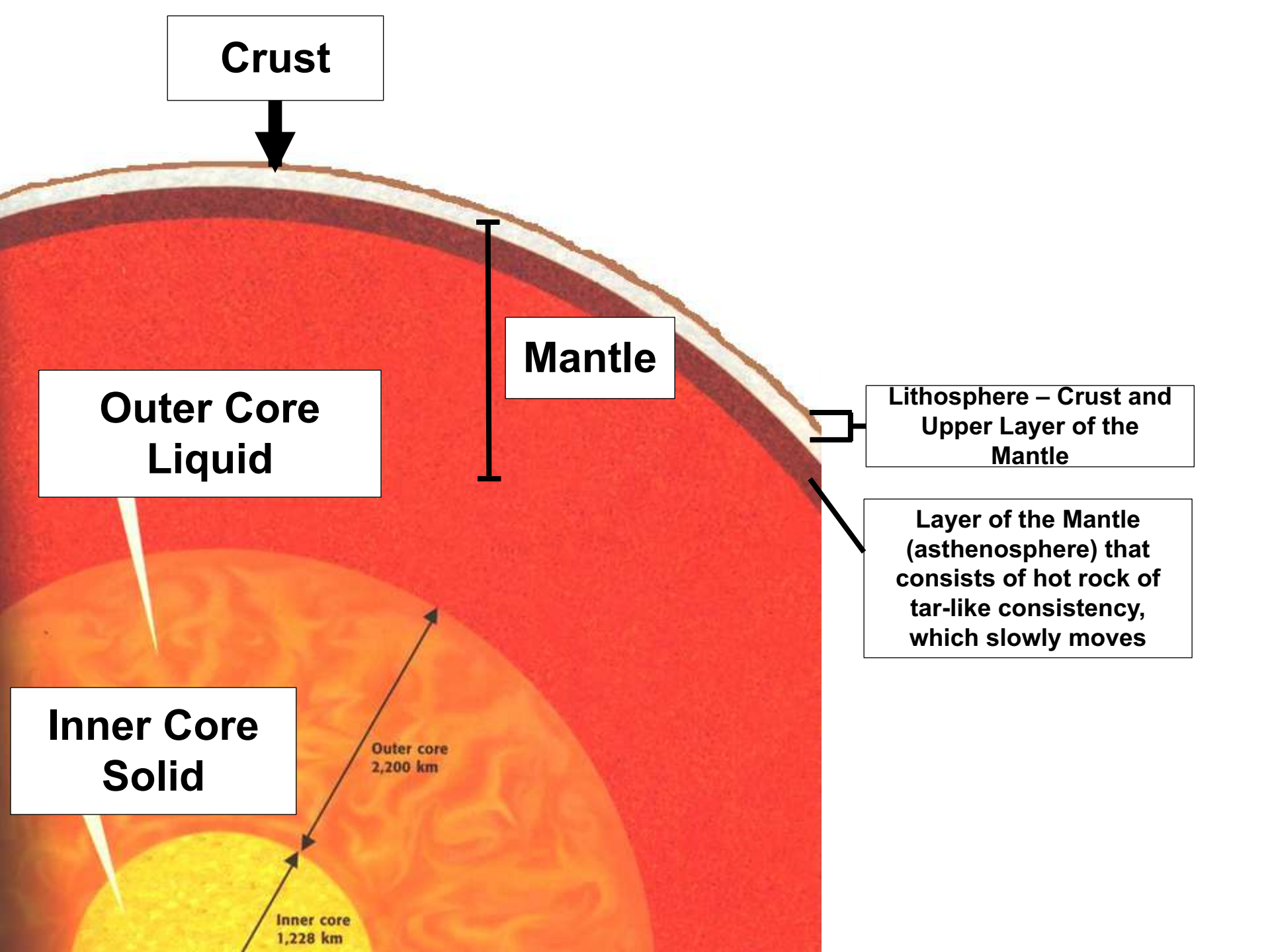

Asthenosphere

The **asthenosphere** ("weak sphere") is a soft layer of the mantle on which pieces of the lithosphere move. It is made of solid rock that, like putty, flows very slowly—at about the same rate your fingernails grow.

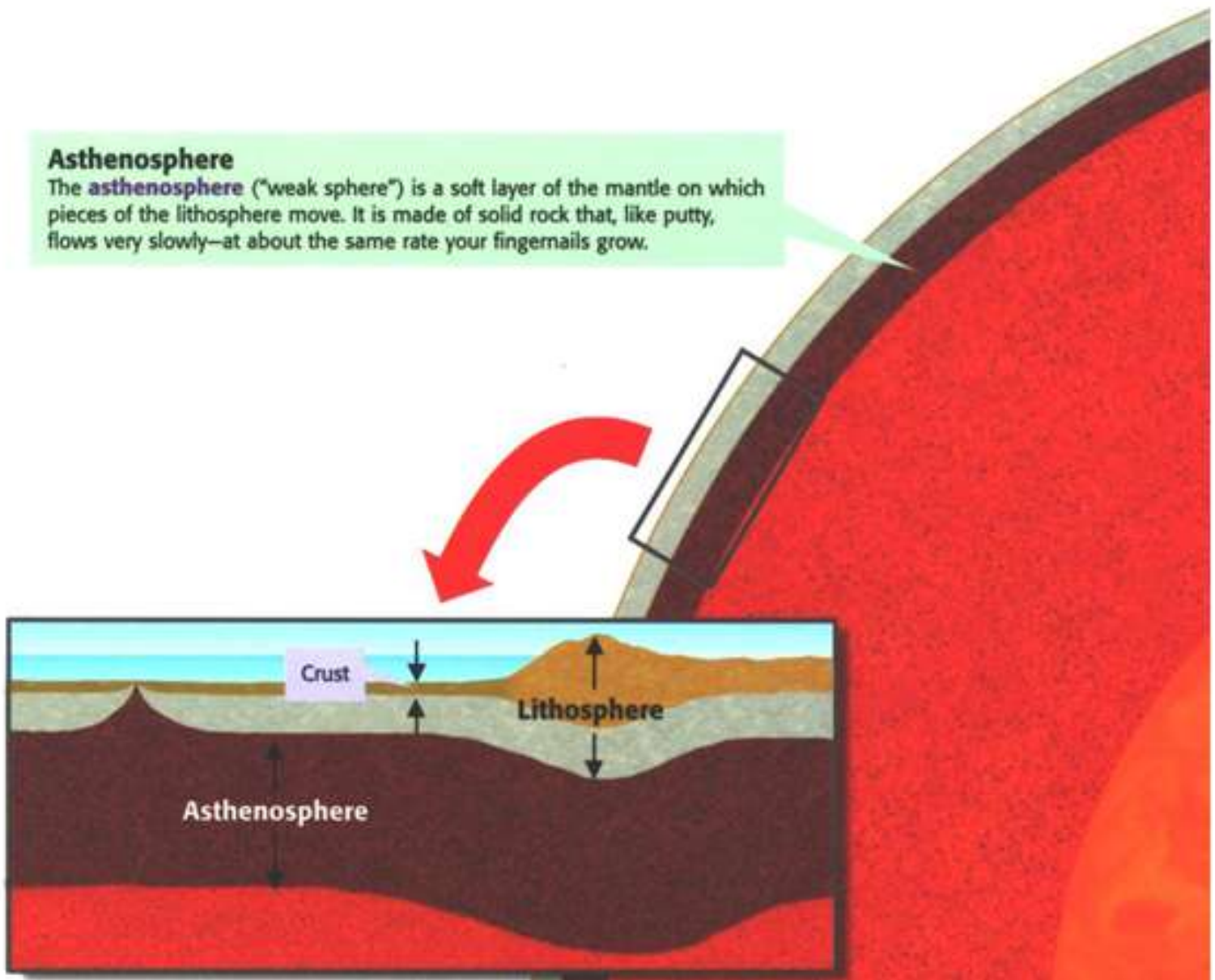

The lithosphere (crust and upper mantle) is divided into separate plates which move very slowly in response to the “convecting” part of the mantle.

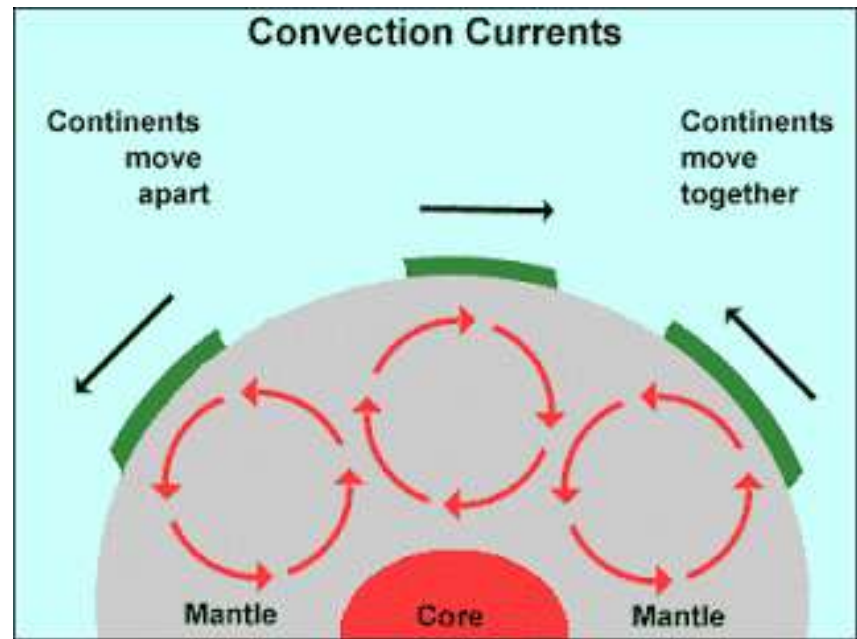

What do these two images tell us about the layers of the Earth?

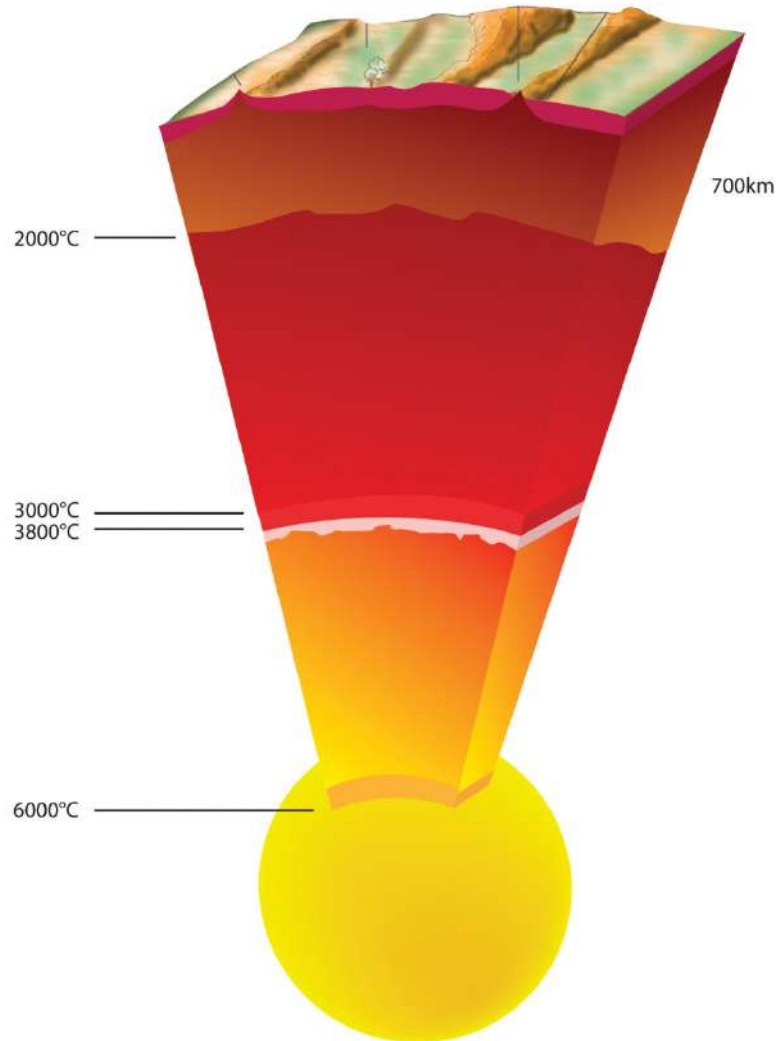

Temperature increases as depth increases



Crust 5-100km

**Mantle
3,000km total**

Look at the information in the graph and table below. What's the relationship between depth and density/pressure?

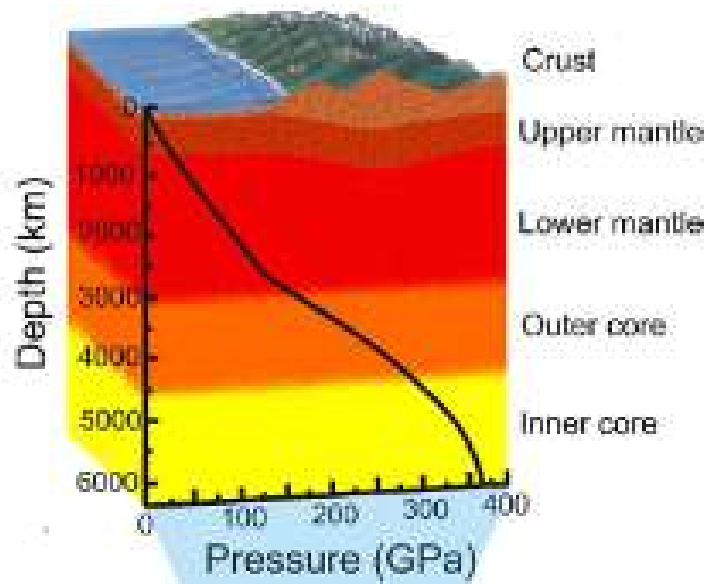
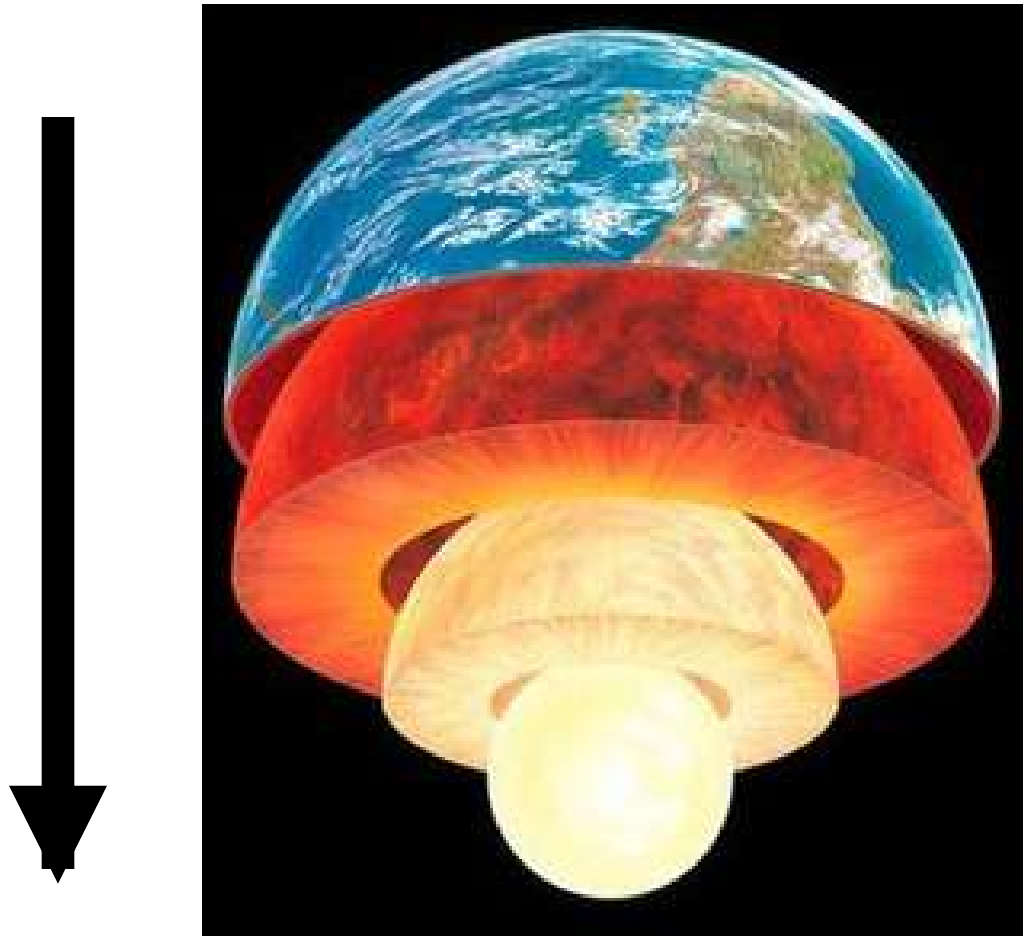
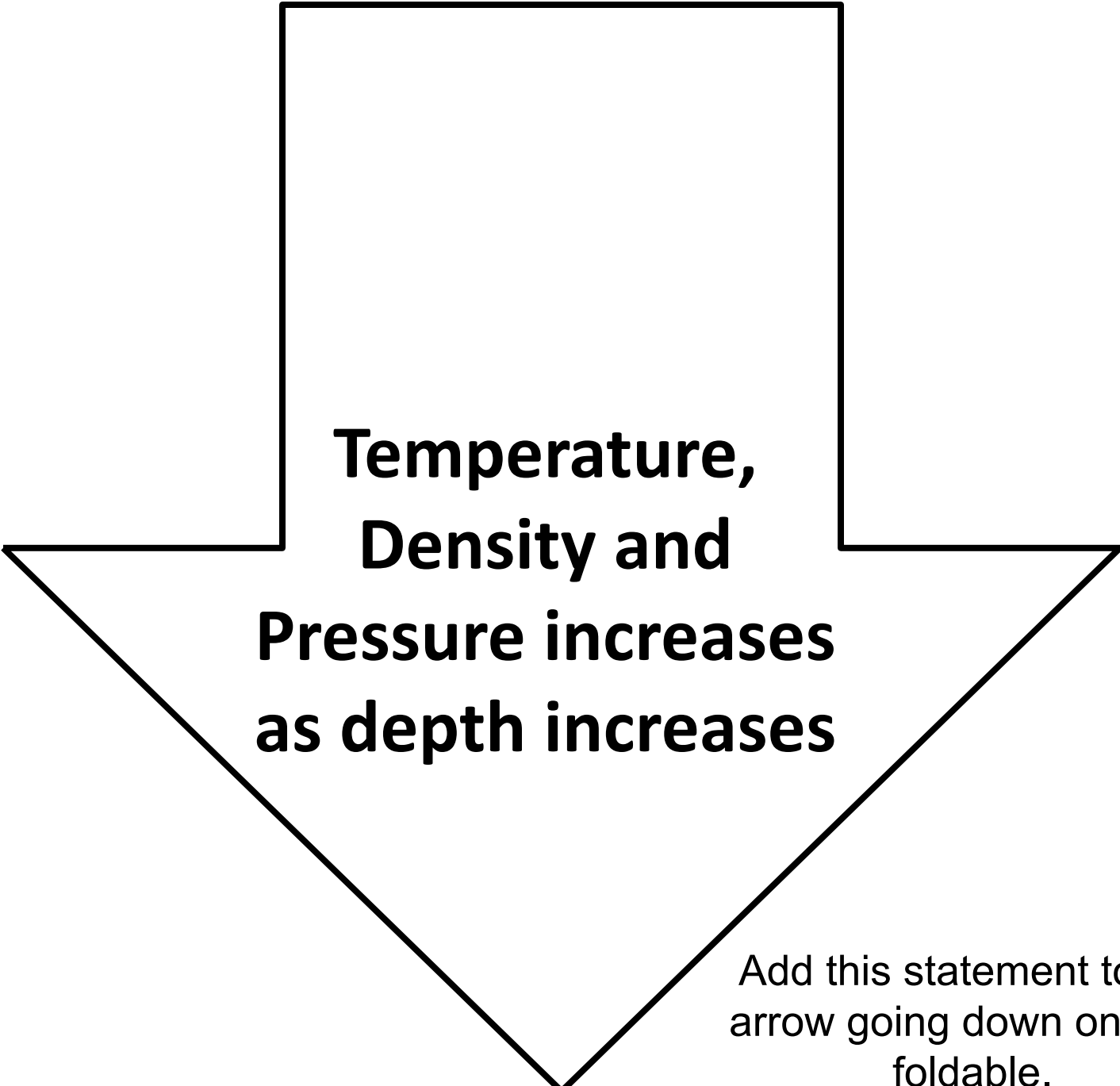

TABLE 1 Interior Properties of Earth

Property	Crust	Mantle	Core
Fraction of Earth	<1% of mass	~70%	~30%
State	"Broken rock"	Plastic	(Semi-)liquid
Depth (kilometers)	0-30	30-3030	3030-6370
Density (grams/cubic centimeter)	2.7	3.5-5.5	10-12
Representative chemical composition	SiO ₂	(Fe,Mg)SiO ₄	Fe, Ni
Temperature (Kelvin)	300-500	500-3,000	3,000-5,300
Pressure (atmospheres)	1-1,000	10 ³ -10 ⁶	10 ⁶ -10 ⁷

Density and Pressure increase as depth increases





**Temperature,
Density and
Pressure increases
as depth increases**

Add this statement to the
arrow going down on your
foldable.

Which layer of the Earth has the greatest temperature, pressure, and density?

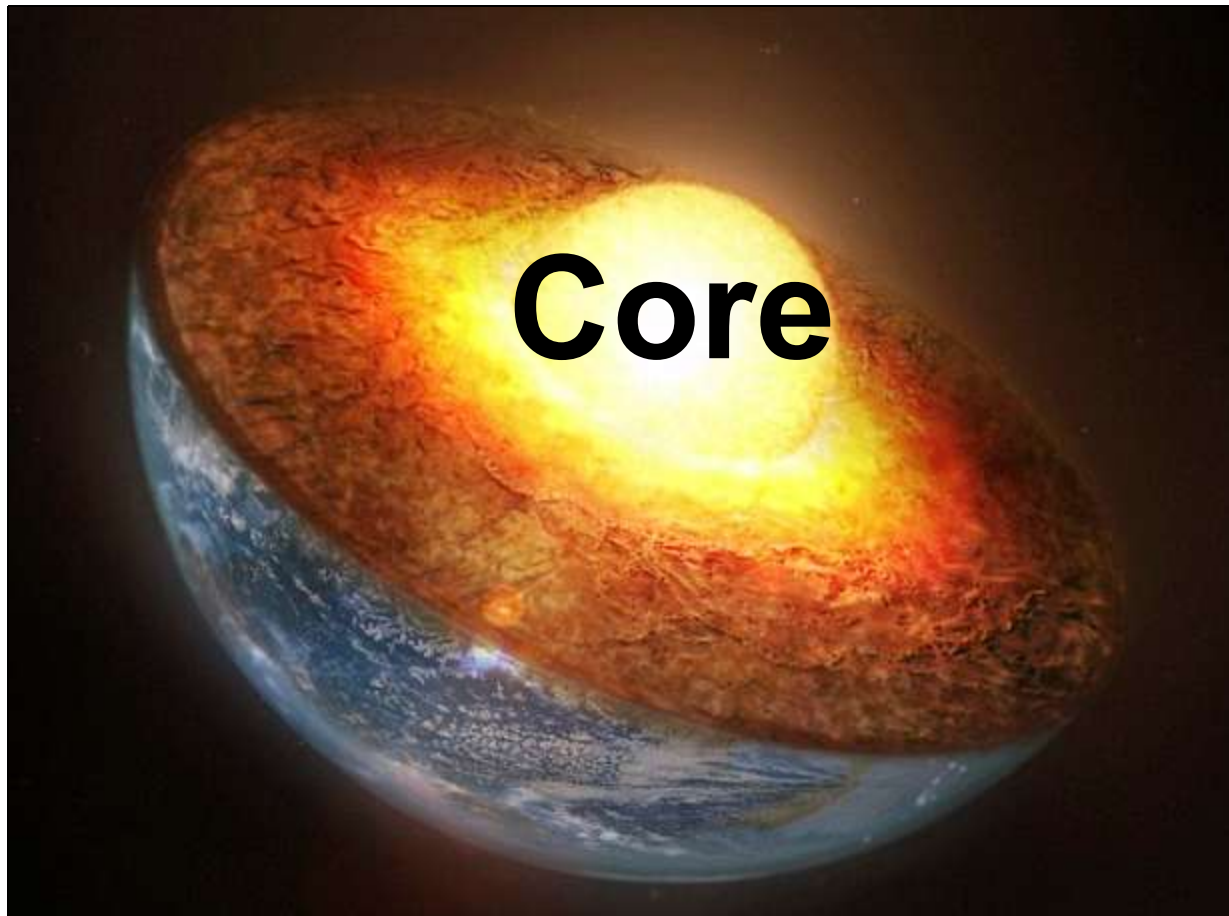

Summary

The earth is layered with a lithosphere (crust and uppermost mantle), convecting mantle, and a dense metallic core.

Pressure, temperature, and density increases as depth increases.

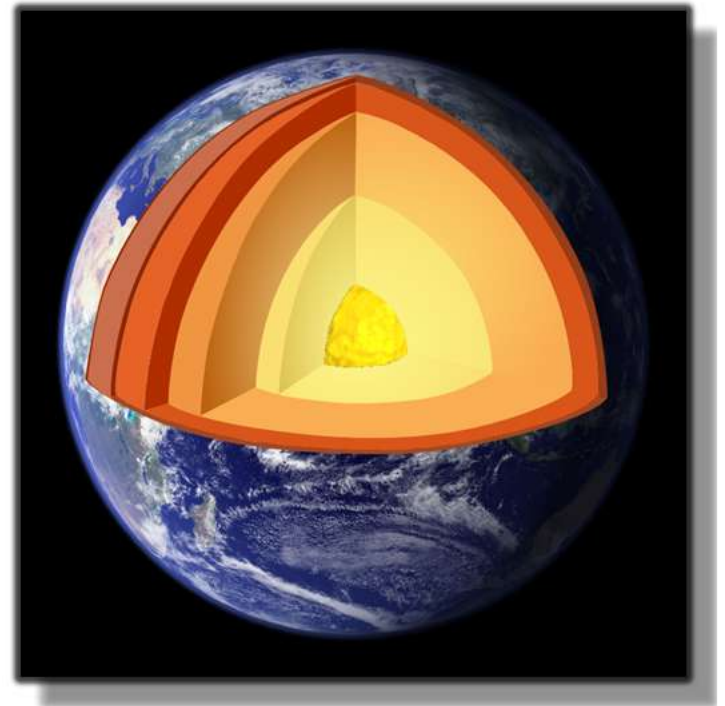

<http://www.learner.org/interactives/dynamicearth/structure.html>

Mr. Lee's Layers of the Earth Rap

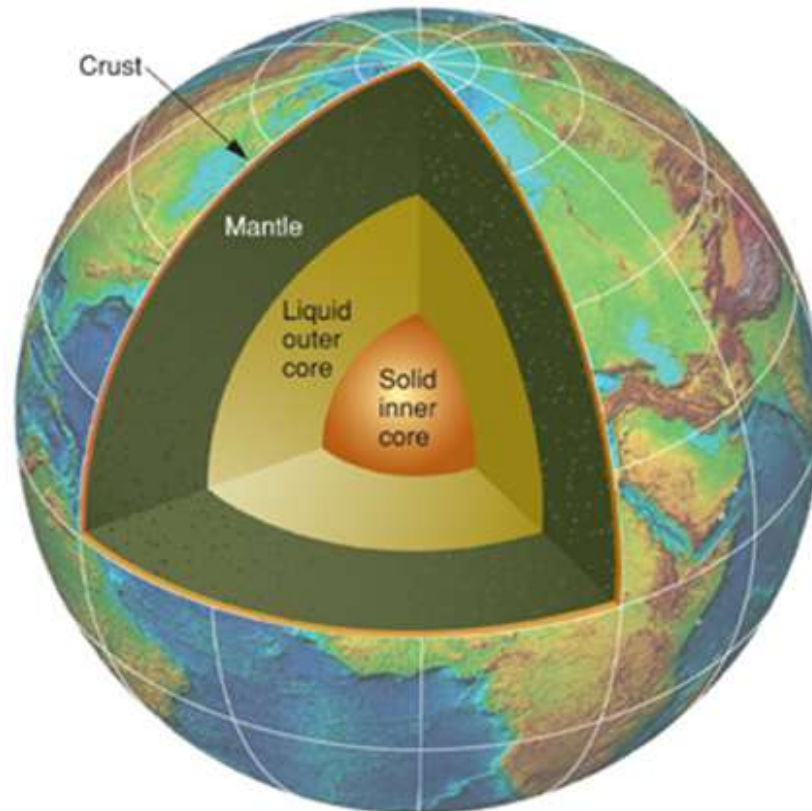

Summarizing

Strategy

Layers of the Earth Summarizer

Name _____ Date _____

Directions: Label the two diagrams with the layers of the earth. Use the following terms: Core, Inner Core, Outer Core, Crust (2), Mantle, Lower Mantle, Middle Mantle, Upper Mantle

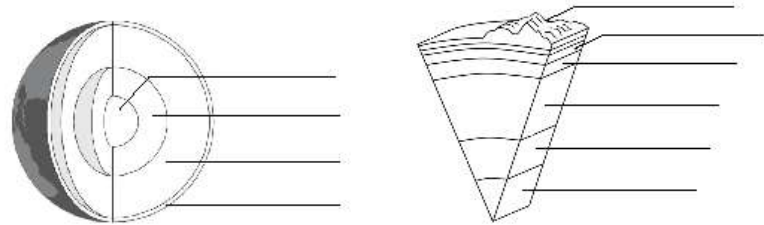

Answer the questions below using the diagrams above.

1. Write the layers of the earth in order from lowest temperature to highest temperature.
2. Which two layers of the earth make up the lithosphere?
3. Temperature, density, and pressure _____ (increases, decreases) as depth _____ (increases, decreases).
4. Which layer of the earth has the highest pressure, temperature, and density?
5. Which of the three main layers of the earth contains convection currents that slowly move lithospheric plates?
6. Which layer of the earth is solid?