

**FIFTH GRADE MATHEMATICS**  
**UNIT 6 STANDARDS**

Dear Parents,

We want to make sure that you have an understanding of the mathematics your child will be learning this year. Below you will find the standards we will be learning in Unit Six. Each standard is in bold print and underlined and below it is an explanation with student examples. Your child is not learning math the way we did when we were in school, so hopefully this will assist you when you help your child at home. Please let your teacher know if you have any questions 😊

**MGSE5.MD.1 Convert among different-sized standard measurement units (mass, weight, length, time, etc.) within a given measurement system (customary and metric) (e.g., convert 5cm to 0.05m), and use these conversions in solving multi-step, real world problems.**

This standard calls for students to convert measurements within the same system of measurement in the context of multi-step, real-world problems. Both customary and standard measurement systems are included; students worked with both metric and customary units of length in second grade. In third grade, students work with metric units of mass and liquid volume. In fourth grade, students work with both systems and begin conversions within systems in length, mass and volume.

Students should explore how the base-ten system supports conversions within the metric system.  
Example: 100 cm = 1 meter.

**MGSE5. MD.2 Make a line plot to display a data set of measurements in fractions of a unit ( $\frac{1}{2}$ ,  $\frac{1}{4}$ ,  $\frac{1}{8}$ ). Use operations on fractions for this grade to solve problems involving information presented in line plots. For example, given different measurements of liquid in identical beakers, find the amount of liquid each beaker would contain if the total amount in all the beakers were**

This standard provides a context for students to work with fractions by measuring objects to one-eighth of a unit. This includes length, mass, and liquid volume. Students are making a line plot of this data and then adding and subtracting fractions based on data in the line plot.

Example:

Students measured objects in their desk to the nearest  $\frac{1}{2}$ ,  $\frac{1}{4}$ , or  $\frac{1}{8}$  of an inch then displayed data collected on a line plot. How many objects measured  $\frac{1}{4}$ ?  $\frac{1}{2}$ ? If you put all the objects together end to end what would be the total length of all the objects?

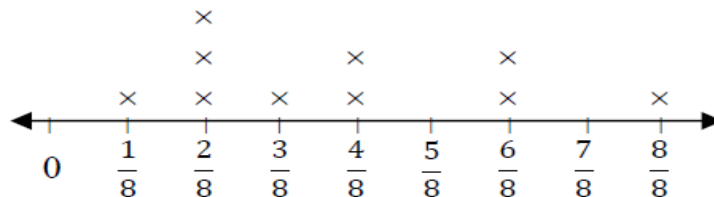

Example:

Ten beakers, measured in liters, are filled with a liquid.

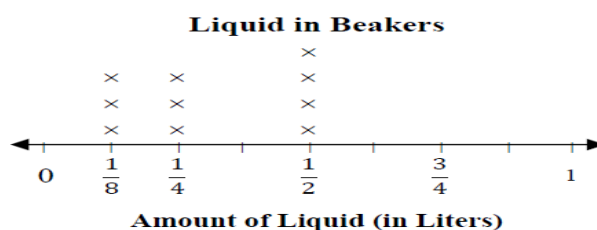

The line plot above shows the amount of liquid in liters in 10 beakers. If the liquid is redistributed equally, how much liquid would each beaker have? (This amount is the mean.)

Students apply their understanding of operations with fractions. They use either addition and/or multiplication to determine the total number of liters in the beakers. Then the sum of the liters is shared evenly among the ten beakers.

### **CCGPS CLUSTER #3: GEOMETRIC MEASUREMENT: UNDERSTAND CONCEPTS OF VOLUME AND RELATE VOLUME TO MULTIPLICATION AND TO ADDITION.**

*Students recognize volume as an attribute of three-dimensional space. They understand that volume can be measured by finding the total number of same size units of volume required to fill the space without gaps or overlaps. They understand that a 1-unit by 1-unit by 1-unit cube is the standard unit for measuring volume. They select appropriate units, strategies, and tools for solving problems that involve estimating and measuring volume. They decompose three-dimensional shapes and find volumes of right rectangular prisms by viewing them as decomposed into layers of arrays of cubes. They measure necessary attributes of shapes in order to determine volumes to solve real world and mathematical problems. Mathematically proficient students communicate precisely by engaging in discussion about their reasoning using appropriate mathematical language. The terms students should learn to use with increasing precision with this cluster are: **measurement, attribute, volume, solid figure, right rectangular prism, unit, unit cube, gap, overlap, cubic units (cubic cm, cubic in. cubic ft. nonstandard cubic units), multiplication, addition, edge lengths, height, area of base.***

#### **MGSE5.MD.3 Recognize volume as an attribute of solid figures and understand concepts of volume measurement.**

- a. A cube with side length 1 unit, called a “unit cube,” is said to have “one cubic unit” of volume, and can be used to measure volume.
- b. A solid figure which can be packed without gaps or overlaps using  $n$  unit cubes is said to have a volume of  $n$  cubic units.

#### **MGSE5.MD.4 Measure volumes by counting unit cubes, using cubic cm, cubic in, cubic ft, and improvised units.**

#### **MGSE5.MD.5 Relate volume to the operations of multiplication and addition and solve real world and mathematical problems involving volume.**

- a. Find the volume of a right rectangular prism with whole- number side lengths by packing it with unit cubes, and show that the volume is the same as would be found by multiplying the edge lengths, equivalently by multiplying the height by the area of the base. Represent threefold whole-number products as volumes, e.g., to represent the associative property of multiplication.
- b. Apply the formulas  $V = l \times w \times h$  and  $V = b \times h$  for rectangular prisms to find volumes of right rectangular prisms with whole-number edge lengths in the context of solving real world and mathematical problems.
- c. Recognize volume as additive. Find volumes of solid figures composed of two non-overlapping right rectangular prisms by adding the volumes of the non-overlapping parts, applying this technique to solve real world problems

**CCGPS.5.MD.3, CCGPS.5.MD.4, and CCGPS.5.MD.5:** *These standards represent the first time that students begin exploring the concept of volume. In third grade, students begin working with area and covering spaces. The concept of volume should be extended from area with the idea that students are covering an area (the bottom of cube) with a layer of unit cubes and then adding layers of unit cubes on top of bottom layer (see picture below). Students should have ample experiences with concrete manipulatives before moving to pictorial representations. Students’ prior experiences with volume were restricted to liquid volume. As students develop their understanding volume they understand that a 1-unit by 1-unit by 1-unit cube is the standard unit for measuring volume. This cube has a length of 1 unit, a width of 1 unit and a height of 1 unit and is called a cubic unit. This cubic unit is written with an exponent of 3 (e.g.,  $\text{in}^3$ ,  $\text{m}^3$ ). Students connect this notation to their understanding of powers of 10 in our place value system. Models of cubic inches, centimeters, cubic feet, etc are helpful in developing an image of a cubic unit. Students estimate how many cubic yards would be needed to fill the classroom or how many cubic centimeters would be needed to fill a pencil box.*

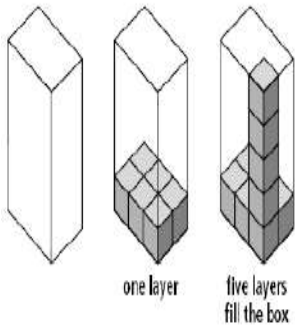

$(3 \times 2)$  represented by first layer  
 $(3 \times 2) \times 5$  represented by number of  
 $3 \times 2$  layers  
 $(3 \times 2) + (3 \times 2) + (3 \times 2) + (3 \times 2) + (3 \times 2) = 6 + 6 + 6 + 6 + 6 = 30$   
 $6$  representing the size/area of one layer

$(3 \times 2)$  represents the number of blocks in the first layer

$(3 \times 2) \times 5$  represents the number of blocks in 5 layers

$6 \times 5$  represents the number of block to fill the figure

30 blocks fill the figure

**CCGPS.5.MD.5a and CCGPS.5.MD.5b:**

These standards involve finding the volume of right rectangular prisms. (See diagram below.) Students should have experiences to describe and reason about why the formula is true. Specifically that they are covering the bottom of a right rectangular prism (length  $\times$  width) with multiple layers (height). Therefore, the formula (length  $\times$  width  $\times$  height) is an extension of the formula for the area of a rectangle.

**CCGPS.5.MD.5c:**

This standard calls for students to extend their work with the area of composite figures into the context of volume. Students should be given concrete experiences of breaking apart (decomposing) 3-dimensional figures into right rectangular prisms in order to find the volume of the entire 3-dimensional figure.

Example:

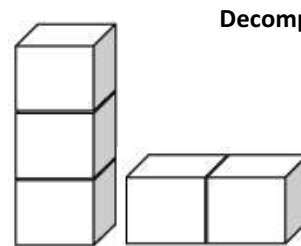
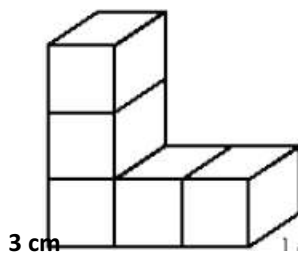

**Decomposed figure**

Example:

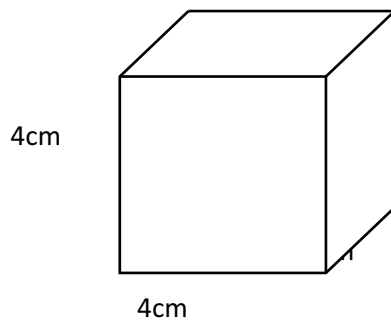

Example:

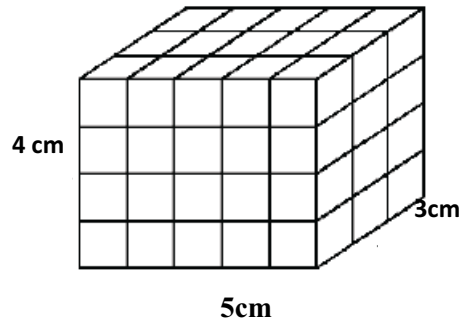

Students need multiple opportunities to measure volume by filling rectangular prisms with cubes and looking at the relationship between the total volume and the area of the base. They derive the volume formula (volume equals the area of the base times the height) and explore how this idea would apply to other prisms. Students use the associative property of multiplication and decomposition of numbers using factors to investigate rectangular prisms with a given number of cubic units.

Example:

When given 24 cubes, students make as many rectangular prisms as possible with a volume of 24 cubic units. Students build the prisms and record possible dimensions.

Length	Width	Height
1	2	12
2	2	6
4	2	3
8	3	1

Example:

Students determine the volume of concrete needed to build the steps in the diagram at the right.

