



# Georgia Standards of Excellence Grade Level Curriculum Overview

## Mathematics

GSE Fifth Grade



Richard Woods, Georgia's School Superintendent  
"Educating Georgia's Future"

# Georgia Department of Education

## **TABLE OF CONTENTS** (\* indicates recent addition to the Grade Level Overview)

<a href="#">Curriculum Map</a> .....	3
Unpacking the Standards .....	4
• <a href="#">Standards For Mathematical Practice</a> .....	4
• <a href="#">Content Standards</a> .....	5
* <a href="#">Mindset and Mathematics</a> .....	49
* <a href="#">Vertical Understanding of the Mathematics Learning Trajectory</a> .....	50
* <a href="#">Research of Interest to Teachers</a> .....	51
* <a href="#">GloSS and IKAN</a> .....	51
<a href="#">Fluency</a> .....	51
<a href="#">Arc of Lesson/Math Instructional Framework</a> .....	52
<a href="#">Unpacking a Task</a> .....	53
<b><u>Routines and Rituals</u></b>	
• <a href="#">Teaching Math in Context and Through Problems</a> .....	54
• <a href="#">Use of Manipulatives</a> .....	55
• <a href="#">Use of Strategies and Effective Questioning</a> .....	56
• <a href="#">Number Lines</a> .....	56
• <a href="#">Math Maintenance Activities</a> .....	57
○ <a href="#">Number Corner/Calendar Time</a> .....	59
○ <a href="#">Number Talks</a> .....	60
○ <a href="#">Estimation/Estimation 180</a> .....	62
• <a href="#">Mathematize the World through Daily Routines</a> .....	65
• <a href="#">Workstations and Learning Centers</a> .....	65
• <a href="#">Games</a> .....	65
• <a href="#">Journaling</a> .....	66
<a href="#">General Questions for Teacher Use</a> .....	67
<a href="#">Questions for Teacher Reflection</a> .....	68
<a href="#">Depth of Knowledge</a> .....	69
<a href="#">Depth and Rigor Statement</a> .....	70
<b><u>Additional Resources</u></b>	
<a href="#">3-5 Problem Solving Rubric</a> (creation of Richmond County Schools).....	71
<a href="#">Literature Resources</a> .....	72
<a href="#">Technology Links</a> .....	72
<a href="#">Resources Consulted</a> .....	73
**Please note that all changes made will appear in green.	

## Georgia Department of Education

### GSE Fifth Grade Curriculum Map

GSE Fifth Grade Curriculum Map							
Unit 1	Unit 2	Unit 3	Unit 4	Unit 5	Unit 6	Unit 7	Unit 8
<b>Order of Operations and Whole Numbers</b>	<b>Adding and Subtracting with Decimals</b>	<b>Multiplying and Dividing with Decimals</b>	<b>Adding, Subtracting, Multiplying and Dividing Fractions</b>	<b>2D Figures</b>	<b>Volume and Measurement</b>	<b>Geometry and the Coordinate Plane</b>	<b>Show What We Know</b>
MGSE5.OA.1 MGSE5.OA.2 MGSE5.NBT.1 MGSE5.NBT.2 MGSE5.NBT.5 MGSE5.NBT.6	MGSE5.NBT.1 MGSE5.NBT.3 MGSE5.NBT.4 MGSE5.NBT.7	MGSE5.NBT.2 MGSE5.NBT.7	MGSE5.NF.1 MGSE5.NF.2 MGSE5.NF.3 MGSE5.NF.4 MGSE5.NF.5 MGSE5.NF.6 MGSE5.NF.7 MGSE5.MD.2	MGSE5.G.3 MGSE5.G.4	MGSE5.MD.1 MGSE5.MD.2 MGSE5.MD.3 MGSE5.MD.4 MGSE5.MD.5	MGSE5.G.1 MGSE5.G.2 MGSE5.OA.3	<b>ALL</b>

These units were written to build upon concepts from prior units, so later units contain tasks that depend upon the concepts addressed in earlier units. All units will include the Mathematical Practices and indicate skills to maintain. However, the progression of the units is at the discretion of districts.

**NOTE:** Mathematical standards are interwoven and should be addressed throughout the year in as many different units and tasks as possible in order to stress the natural connections that exist among mathematical topics.

**Grades 3-5 Key:** G= Geometry, MD=Measurement and Data, NBT= Number and Operations in Base Ten, NF = Number and Operations, Fractions, OA = Operations and Algebraic Thinking.

**STANDARDS FOR MATHEMATICAL PRACTICE**

*Mathematical Practices are listed with each grade's mathematical content standards to reflect the need to connect the mathematical practices to mathematical content in instruction.*

The Standards for Mathematical Practice describe varieties of expertise that mathematics educators at all levels should seek to develop in their students. These practices rest on important “processes and proficiencies” with longstanding importance in mathematics education. The first of these are the NCTM process standards of problem solving, reasoning and proof, communication, representation, and connections. The second are the strands of mathematical proficiency specified in the National Research Council’s report *Adding It Up*: adaptive reasoning, strategic competence, conceptual understanding (comprehension of mathematical concepts, operations and relations), procedural fluency (skill in carrying out procedures flexibly, accurately, efficiently and appropriately), and productive disposition (habitual inclination to see mathematics as sensible, useful, and worthwhile, coupled with a belief in diligence and one’s own efficacy).

***Students are expected to:***

**1. Make sense of problems and persevere in solving them.**

Students solve problems by applying their understanding of operations with whole numbers, decimals, and fractions including mixed numbers. They solve problems related to volume and measurement conversions. Students seek the meaning of a problem and look for efficient ways to represent and solve it. They may check their thinking by asking themselves, “What is the most efficient way to solve the problem?”, “Does this make sense?”, and “Can I solve the problem in a different way?”

**2. Reason abstractly and quantitatively.**

Fifth graders should recognize that a number represents a specific quantity. They connect quantities to written symbols and create a logical representation of the problem at hand, considering both the appropriate units involved and the meaning of quantities. They extend this understanding from whole numbers to their work with fractions and decimals. Students write simple expressions that record calculations with numbers and represent or round numbers using place value concepts.

**3. Construct viable arguments and critique the reasoning of others.**

In fifth grade, students may construct arguments using concrete referents, such as objects, pictures, and drawings. They explain calculations based upon models and properties of operations and rules that generate patterns. They demonstrate and explain the relationship between volume and multiplication. They refine their mathematical communication skills as they participate in mathematical discussions involving questions like “How did you get that?” and “Why is that true?” They explain their thinking to others and respond to others’ thinking.

**4. Model with mathematics.**

Students experiment with representing problem situations in multiple ways including numbers, words (mathematical language), drawing pictures, using objects, making a chart, list, or graph, creating equations, etc. Students need opportunities to connect the different representations and explain the connections. They should be able to use all of these representations as needed. Fifth

## Georgia Department of Education

graders should evaluate their results in the context of the situation and whether the results make sense. They also evaluate the utility of models to determine which models are most useful and efficient to solve problems.

### **5. Use appropriate tools strategically.**

Fifth graders consider the available tools (including estimation) when solving a mathematical problem and decide when certain tools might be helpful. For instance, they may use unit cubes to fill a rectangular prism and then use a ruler to measure the dimensions. They use graph paper to accurately create graphs and solve problems or make predictions from real world data.

### **6. Attend to precision.**

Students continue to refine their mathematical communication skills by using clear and precise language in their discussions with others and in their own reasoning. Students use appropriate terminology when referring to expressions, fractions, geometric figures, and coordinate grids. They are careful about specifying units of measure and state the meaning of the symbols they choose. For instance, when figuring out the volume of a rectangular prism they record their answers in cubic units.

### **7. Look for and make use of structure.**

In fifth grade, students look closely to discover a pattern or structure. For instance, students use properties of operations as strategies to add, subtract, multiply and divide with whole numbers, fractions, and decimals. They examine numerical patterns and relate them to a rule or a graphical representation.

### **8. Look for and express regularity in repeated reasoning.**

Fifth graders use repeated reasoning to understand algorithms and make generalizations about patterns. Students connect place value and their prior work with operations to understand algorithms to fluently multiply multi-digit numbers and perform all operations with decimals to hundredths. Students explore operations with fractions with visual models and begin to formulate generalizations.

***\*\*\*Mathematical Practices 1 and 6 should be evident in EVERY lesson\*\*\****

## **CONTENT STANDARDS**

### **OPERATIONS AND ALGEBRAIC THINKING**

#### **MGSE CLUSTER #1: WRITE AND INTERPRET NUMERICAL EXPRESSIONS.**

*Mathematically proficient students communicate precisely by engaging in discussion about their reasoning using appropriate mathematical language. The terms students should learn to use with increasing precision with this cluster are: **parentheses, brackets, braces, numerical expressions.***

**See the K-5 wiki for important article on Order of Operations: <http://ccgpsmathematicsk-5.wikispaces.com/2016-2017+Documents>**

**MGSE5.OA.1 Use parentheses, brackets, or braces in numerical expressions, and evaluate expressions with these symbols.**

## Georgia Department of Education

The standard calls for students to evaluate expressions with parentheses ( ), brackets [ ] or braces { }. In upper levels of mathematics, evaluate means to substitute for a variable and simplify the expression. However at this level students are to only simplify the expressions because there are no variables.

Bill McCallum, Common Core author, states:

*In general students in Grade 5 will be using parentheses only, because the convention about nesting that you describe is quite common, and it's quite possible that instructional materials at this level wouldn't even mention brackets and braces. However, the nesting order is only a convention, not a mathematical law; the North Carolina statement (see NC unpacked standards) isn't quite right here. It's important to distinguish between mathematical laws (e.g. the commutative law) and conventions of notation (e.g. nesting of parentheses). Some conventions of notation are important enough that you want to insist on them in the classroom (e.g. order of operations). But I don't think correct nesting of parentheses falls into that category. The main point of the standard is to understand the structure of numerical expressions with grouping symbols.*

In other words- evaluate expressions with brackets **or** braces **or** parentheses. No nesting at 5<sup>th</sup> grade.

This standard builds on the expectations of third grade where students are expected to start learning the conventional order. Students need experiences with multiple expressions that use grouping symbols throughout the year to develop understanding of when and how to use parentheses, brackets, and braces. First, students use these symbols with whole numbers. Then the symbols can be used as students add, subtract, multiply and divide decimals and fractions.

Examples:

- |  |                          |
|--|--------------------------|
| • $(26 + 18) \div 4$                           | Solution: 11             |
| • $12 - (0.4 \times 2)$                        | Solution: 11.2           |
| • $(2 + 3) \times (1.5 - 0.5)$                 | Solution: 5              |
| • $6 - \left(\frac{1}{2} + \frac{1}{3}\right)$ | Solution: $5\frac{1}{6}$ |

To further develop students' understanding of grouping symbols and facility with operations, students place grouping symbols in equations to make the equations true or they compare expressions that are grouped differently.

Example:

- $15 - 7 - 2 = 10 \rightarrow 15 - (7 - 2) = 10$
- Compare  $3 \times 2 + 5$  and  $3 \times (2 + 5)$ .
- Compare  $15 - 6 + 7$  and  $15 - (6 + 7)$ .

### **MGSE5.OA.2 Write simple expressions that record calculations with numbers, and interpret numerical expressions without evaluating them**

This standard refers to expressions. Expressions are a series of numbers and symbols (+, -, x, ÷) without an equals sign. Equations result when two expressions are set equal to each other ( $2 + 3 = 4 + 1$ ).

## Georgia Department of Education

Example:

- $4(5 + 3)$  is an expression.
- When we compute  $4(5 + 3)$  we are evaluating the expression. The expression equals 32.
- $4(5 + 3) = 32$  is an equation.

This standard calls for students to verbally describe the relationship between expressions without actually calculating them. This standard calls for students to apply their reasoning of the four operations as well as place value while describing the relationship between numbers. The standard does not include the use of variables, only numbers and signs for operations.

Example:

**Write:**

Write an expression for the steps “double five and then add 26.”

**Student:**  $(2 \times 5) + 26$

**Interpret:**

Describe how the expression  $5(10 \times 10)$  relates to  $10 \times 10$ .

**Student:**

The expression  $5(10 \times 10)$  is 5 times larger than the expression  $10 \times 10$  since I know that I that  $5(10 \times 10)$  means that I have 5 groups of  $(10 \times 10)$ .

### Common Misconceptions

Students may believe the order in which a problem with mixed operations is written is the order to solve the problem. Allow students to use calculators to determine the value of the expression, and then discuss the order the calculator used to evaluate the expression. Do this with four-function and scientific calculators.

### MGSE CLUSTER#2: ANALYZE PATTERNS AND RELATIONSHIPS.

*Mathematically proficient students communicate precisely by engaging in discussion about their reasoning using appropriate mathematical language. The terms students should learn to use with increasing precision with this cluster are: **numerical patterns, rules, ordered pairs, coordinate plane.***

**MGSE5.OA.3 Generate two numerical patterns using a given rule. Identify apparent relationships between corresponding terms by completing a function table or input/output table. Using the terms created, form and graph ordered pairs on a coordinate plane.**

This standard extends the work from 4<sup>th</sup> grade, where students generate numerical patterns when they are given one rule. In 5<sup>th</sup> grade, students are given two rules and generate two numerical patterns. In 5<sup>th</sup> grade, the graphs that are created should be line graphs to represent the pattern.

## Georgia Department of Education

Example:

Sam and Terri live by a lake and enjoy going fishing together every day for five days. Sam catches 2 fish every day, and Terri catches 4 fish every day.

1. Make a chart (table) to represent the number of fish that Sam and Terri catch.

Days	Sam's Total Number of Fish	Terri's Total Number of Fish
0	0	0
1	2	4
2	4	8
3	6	12
4	8	16
5	10	20

This is a linear function which is why we get the straight lines. The Days are the independent variable, Fish are the dependent variables, and the constant rate is what the rule identifies in the table.

2. Describe the pattern.

Since Terri catches 4 fish each day, and Sam catches 2 fish, the amount of Terri's fish is always greater. Terri's fish is also always twice as much as Sam's fish.

3. Make a graph of the number of fish. Plot the points on a coordinate plane and make a line graph, and then interpret the graph.

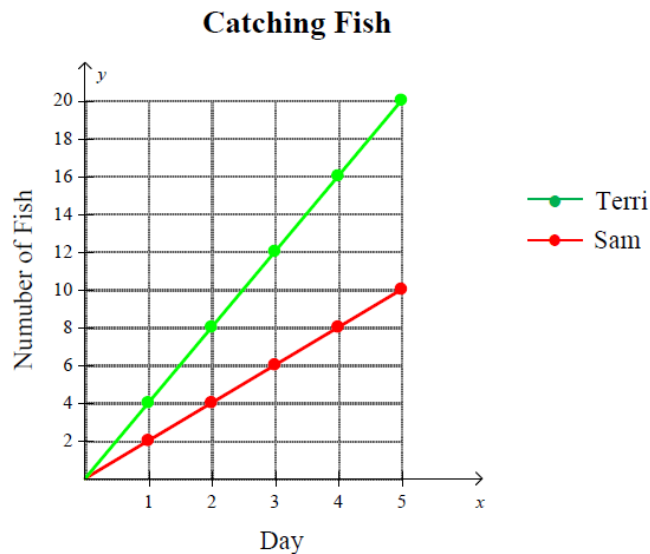

My graph shows that Terri always has more fish than Sam. Terri's fish increases at a higher rate since she catches 4 fish every day. Sam only catches 2 fish every day, so his number of fish increases at a smaller rate than Terri.



## Georgia Department of Education

***Important to note:*** The lines become increasingly further apart. Identify apparent relationships between corresponding terms. (*Additional relationships:* The two lines will never intersect; there will not be a day in which the two friends have the same total of fish. Explain the relationship between the number of days that has passed and the number of fish each friend has: Sam catches  $2n$  fish, Terri catches  $4n$  fish, where  $n$  is the number of days.)

Example:

- Use the rule “add 3” to write a sequence of numbers.  
*Starting with a 0, students write 0, 3, 6, 9, 12, . . .*
- Use the rule “add 6” to write a sequence of numbers.  
*Starting with 0, students write 0, 6, 12, 18, 24, . . .*

After comparing these two sequences, the students notice that each term in the second sequence is twice the corresponding terms of the first sequence. One way they justify this is by describing the patterns of the terms. Their justification may include some mathematical notation (See example below). A student may explain that both sequences start with zero and to generate each term of the second sequence he/she added 6, which is twice as much as was added to produce the terms in the first sequence. Students may also use the distributive property to describe the relationship between the two numerical patterns by reasoning that  $6 + 6 + 6 = 2(3 + 3 + 3)$ .

$$0, \overset{+3}{3}, \overset{+3}{6}, \overset{+3}{9}, \overset{+3}{12}, \dots \qquad 0, \overset{+6}{6}, \overset{+6}{12}, \overset{+6}{18}, \overset{+6}{24}, \dots$$

Once students can describe that the second sequence of numbers is twice the corresponding terms of the first sequence, the terms can be written in ordered pairs and then graphed on a coordinate grid. They should recognize that each point on the graph represents two quantities in which the second quantity is twice the first quantity.

Ordered pairs

Graph

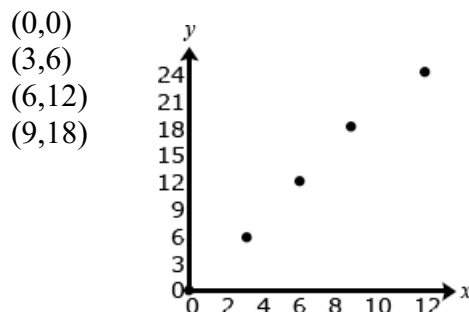

### Common Misconceptions

Students reverse the points when plotting them on a coordinate plane. They count up first on the y-axis and then count over on the x-axis. The location of every point in the plane has a specific place. Have students plot points where the numbers are reversed such as (4, 5) and (5, 4). Begin

## Georgia Department of Education

with students providing a verbal description of how to plot each point. Then, have them follow the verbal description and plot each point.

## NUMBER AND OPERATIONS IN BASE TEN

### **MGSE CLUSTER #1: UNDERSTAND THE PLACE VALUE SYSTEM.**

*Mathematically proficient students communicate precisely by engaging in discussion about their reasoning using appropriate mathematical language. The terms students should learn to use with increasing precision with this cluster are: **place value, decimal, decimal point, patterns, multiply, divide, tenths, thousands, greater than, less than, equal to, <, >, =, compare/ comparison, round.***

### **MGSE5.NBT.1 Recognize that in a multi-digit number, a digit in one place represents 10 times as much as it represents in the place to its right and 1/10 of what it represents in the place to its left.**

This standard calls for students to reason about the magnitude of numbers. Students should work with the idea that the tens place is ten times as much as the ones place, and the ones place is  $1/10^{\text{th}}$  the size of the tens place. In 4<sup>th</sup> grade, students examined the relationships of the digits in numbers for whole numbers only. This standard extends this understanding to the relationship of decimal fractions. Students use base ten blocks, pictures of base ten blocks, and interactive images of base ten blocks to manipulate and investigate the place value relationships. They use their understanding of unit fractions to compare decimal places and fractional language to describe those comparisons.

Before considering the relationship of decimal fractions, students express their understanding that in multi-digit whole numbers, a digit in one place represents 10 times what it represents in the place to its right and  $1/10$  of what it represents in the place to its left.

Example:

The 2 in the number 542 is different from the value of the 2 in 324. The 2 in 542 represents 2 ones or 2, while the 2 in 324 represents 2 tens or 20. Since the 2 in 324 is one place to the left of the 2 in 542 the value of the 2 is 10 times greater. Meanwhile, the 4 in 542 represents 4 tens or 40 and the 4 in 324 represents 4 ones or 4. Since the 4 in 324 is one place to the right of the 4 in 542 the value of the 4 in the number 324 is  $1/10^{\text{th}}$  of its value in the number 542.

Example:

A student thinks, “I know that in the number 5555, the 5 in the tens place (5555) represents 50 and the 5 in the hundreds place (5555) represents 500. So a 5 in the hundreds place is ten times as much as a 5 in the tens place or a 5 in the tens place is  $1/10^{\text{th}}$  of the value of a 5 in the hundreds place.

Based on the base-10 number system, digits to the left are times as great as digits to the right; likewise, digits to the right are  $1/10^{\text{th}}$  of digits to the left. For example, the 8 in 845 has a value of 800 which is ten times as much as the 8 in the number 782. In the same spirit, the 8 in 782 is  $1/10^{\text{th}}$  the value of the 8 in 845.

To extend this understanding of place value to their work with decimals, students use a model of one unit; they cut it into 10 equal pieces, shade in, or describe  $1/10^{\text{th}}$  of that model using fractional language. (“This is 1 out of 10 equal parts. So it is  $1/10$ . I can write this using  $1/10$  or 0.1.”) They repeat the process by finding  $1/10$  of a  $1/10$  (e.g., dividing  $1/10$  into 10 equal parts

## Georgia Department of Education

to arrive at  $1/100$  or  $0.01$ ) and can explain their reasoning: “ $0.01$  is  $1/10$  of  $1/10$  thus is  $1/100$  of the whole unit.”

In the number  $55.55$ , each digit is  $5$ , but the value of the digits is different because of the placement.

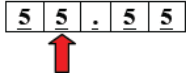

The  $5$  that the arrow points to is  $1/10$  of the  $5$  to the left and  $10$  times the  $5$  to the right. The  $5$  in the ones place is  $1/10$  of  $50$  and  $10$  times five tenths.

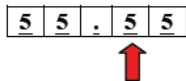

The  $5$  that the arrow points to is  $1/10$  of the  $5$  to the left and  $10$  times the  $5$  to the right. The  $5$  in the tenths place is  $10$  times five hundredths.

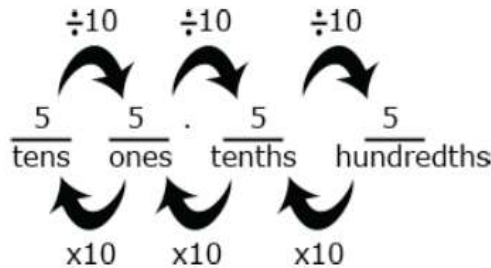

**MGSE5.NBT.2 Explain patterns in the number of zeros of the product when multiplying a number by powers of 10, and explain patterns in the placement of the decimal point when a decimal is multiplied or divided by a power of 10. Use whole-number exponents to denote powers of 10.**

This standard includes multiplying by multiples of 10 and powers of 10, including  $10^2$  which is  $10 \times 10 = 100$ , and  $10^3$  which is  $10 \times 10 \times 10 = 1,000$ . Students should have experiences working with connecting the pattern of the number of zeros in the product when you multiply by powers of 10. It is a shift in the digits.

Examples:

$$2.5 \times 10^3 = 2.5 \times (10 \times 10 \times 10) = 2.5 \times 1,000 = 2,500$$

Students should reason that the exponent above the 10 indicates how many places the digits are moving (not just that the digits are moving but that you are multiplying or making the number 10 times greater three times) when you multiply by a power of 10. Since we are multiplying by a power of 10, the digits shift to the left.

$$350 \div 10^3 = 350 \div 1,000 = 0.350 = 0.35$$

$$350/10 = 35$$

$$(350 \times 1/10)$$

$$35/10 = 3.5$$

$$(35 \times 1/10)$$

$$3.5/10 = 0.35$$

$$(3.5 \times 1/10)$$

## Georgia Department of Education

This will relate well to subsequent work with operating with fractions. This example shows that when we divide by powers of 10, the exponent above the 10 indicates how many places the digits are shifting (how many times we are dividing by 10, the number becomes ten times smaller). Since we are dividing by powers of 10, the digits will shift to the right.

Students need to be provided with opportunities to explore this concept and come to this understanding; this should not just be taught procedurally.

Examples:

Students might write:

- $36 \times 10 = 36 \times 10^1 = 360$
- $36 \times 10 \times 10 = 36 \times 10^2 = 3600$
- $36 \times 10 \times 10 \times 10 = 36 \times 10^3 = 36,000$
- $36 \times 10 \times 10 \times 10 \times 10 = 36 \times 10^4 = 360,000$

Students might think and/or say:

I noticed that every time I multiplied by 10, I placed a zero to the end of the number. That makes sense because each digit's value became 10 times larger. To make a digit 10 times larger, I have to shift it one place value to the left.

When I multiplied 36 by 10, the 30 became 300. The 6 became 60 or the 36 became 360. So I had to place a zero at the end to have the 3 tens represent 3 one-hundreds (instead of 3 tens) and the 6 ones represents 6 tens (instead of 6 ones).

Students should be able to use the same type of reasoning as above to explain why the following multiplication and division problem by powers of 10 make sense.

$523 \times 10^3 = 523,000$	The place value of the digits in 523 are increased by 3 places.
$5.223 \times 10^2 = 522.3$	The place value of the digits in 5.223 are increased by 2 places.
$52.3 \div 10^1 = 5.23$	The place value of the digits in 52.3 is decreased by one place.

### **Common Misconceptions**

A common misconception among students regards deriving the rules for multiplying a number by a power of 10. Many students correctly recognize that multiplying a whole number by a power of 10 will result in a product with as many 0s at the end as were in the power of 10. When students transition to multiplying decimals by powers of 10, they often generalize this "rule" without thinking about the value that results. It is important to create dialogue around this misconception, especially during the initial stages of deriving rules for multiplying and dividing numbers by powers of 10.

## Georgia Department of Education

### MGSE5NBT.3 Read, write, and compare decimals to thousandths.

- a. **Read and write decimals to thousandths using base-ten numerals, number names, and expanded form, e.g.,  $347.392 = 3 \times 100 + 4 \times 10 + 7 \times 1 + 3 \times (1/10) + 9 \times (1/100) + 2 \times (1/1000)$ .**
- b. **Compare two decimals to thousandths based on meanings of the digits in each place, using  $>$ ,  $=$ , and  $<$  symbols to record the results of comparisons.**

This standard references expanded form of decimals with fractions included. Students should build on their work from 4<sup>th</sup> grade, where they worked with both decimals and fractions interchangeably. Expanded form is included to build upon work in MGSE5.NBT.2 and deepen students' understanding of place value. Students build on the understanding they developed in fourth grade to read, write, and compare decimals to thousandths. They connect their prior experiences with using decimal notation for fractions and addition of fractions with denominators of 10 and 100. They use concrete models and number lines to extend this understanding to decimals to the thousandths. Models may include base ten blocks, place value charts, grids, pictures, drawings, manipulatives, technology-based, etc. They read decimals using fractional language and write decimals in fractional form, as well as in expanded notation. This investigation leads them to understanding equivalence of decimals ( $0.8 = 0.80 = 0.800$ ).

Comparing decimals builds on work from 4<sup>th</sup> grade.

Example:

Some equivalent forms of 0.72 are:

$72/100$	$70/100 + 2/100$
$7/10 + 2/100$	0.720
$7 \times (1/10) + 2 \times (1/100)$	$7 \times (1/10) + 2 \times (1/100) + 0 \times (1/1000)$
$0.70 + 0.02$	$720/1000$

Students need to understand the size of decimal numbers and relate them to common benchmarks such as 0, 0.5 (0.50 and 0.500), and 1. Comparing tenths to tenths, hundredths to hundredths, and thousandths to thousandths is simplified if students use their understanding of fractions to compare decimals.

Examples:

Comparing 0.25 and 0.17, a student might think, “25 hundredths is more than 17 hundredths”. They may also think that it is 8 hundredths more. They may write this

## Georgia Department of Education

comparison as  $0.25 > 0.17$  and recognize that  $0.17 < 0.25$  is another way to express this comparison.

Comparing 0.207 to 0.26, a student might think, “Both numbers have 2 tenths, so I need to compare the hundredths. The second number has 6 hundredths and the first number has no hundredths so the second number must be larger. Another student might think while writing fractions, “I know that 0.207 is 207 thousandths (and may write  $\frac{207}{1000}$ ). 0.26 is 26 hundredths (and may write  $\frac{26}{100}$ ) but I can also think of it as 260 thousandths ( $\frac{260}{1000}$ ). So, 260 thousandths is more than 207 thousandths.

## Georgia Department of Education

### **MGSE5.NBT.4 Use place value understanding to round decimals up to the hundredths place.**

This standard refers to rounding. Students should go beyond simply applying an algorithm or procedure for rounding. The expectation is that students have a deep understanding of place value and number sense and can explain and reason about the answers they get when they round. Students should have numerous experiences using a number line to support their work with rounding.

Example:

Round 14.235 to the nearest tenth.

Students recognize that the possible answer must be in tenths thus, it is either 14.2 or 14.3. They then identify that 14.235 is closer to 14.2 (14.20) than to 14.3 (14.30).

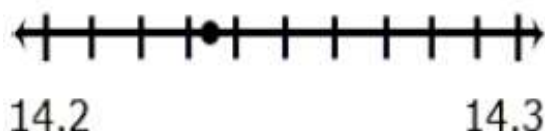

Students should use benchmark numbers to support this work. Benchmarks are convenient numbers for comparing and rounding numbers. 0, 0.5, 1, 1.5 are examples of benchmark numbers.

Example:

Which benchmark number is the best estimate of the shaded amount in the model below?  
Explain your thinking.

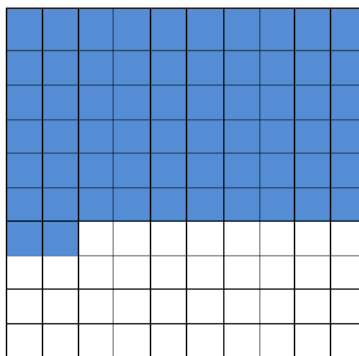

### **Common Misconceptions**

A common misconception that students have when trying to extend their understanding of whole number place value to decimal place value is that as you move to the right of the decimal point, the number increases in value. Reinforcing the concept of powers of ten is essential for addressing this issue.

A second misconception that is directly related to comparing whole numbers is the idea that the longer the number the greater the number. With whole numbers, a 5-digit number is always greater than a 1-, 2-, 3-, or 4-digit number. However, with decimals a number with one decimal



## Georgia Department of Education

place may be greater than a number with two or three decimal places. For example, 0.5 is greater than 0.12, 0.009 or 0.499. One method for comparing decimals is to make all numbers have the same number of digits to the right of the decimal point by adding zeros to the number, such as 0.500, 0.120, 0.009 and 0.499. A second method is to use a place-value chart to place the numerals for comparison.

### **MGSE CLUSTER #2: PERFORM OPERATIONS WITH MULTI-DIGIT WHOLE NUMBERS AND WITH DECIMALS TO HUNDREDTHS.**

*Students develop understanding of why division procedures work based on the meaning of base-ten numerals and properties of operations. They finalize fluency with multi-digit addition, subtraction, multiplication, and division. They apply their understandings of models for decimals, decimal notation, and properties of operations to add and subtract decimals to hundredths. They develop fluency in these computations, and make reasonable estimates of their results. Students use the relationship between decimals and fractions, as well as the relationship between finite decimals and whole numbers (i.e., a finite decimal multiplied by an appropriate power of 10 is a whole number), to understand and explain why the procedures for multiplying and dividing finite decimals make sense. They compute products and quotients of decimals to hundredths efficiently and accurately. Mathematically proficient students communicate precisely by engaging in discussion about their reasoning using appropriate mathematical language. The terms students should learn to use with increasing precision with this cluster are: multiplication/multiply, division/division, decimal, decimal point, tenths, hundredths, products, quotients, dividends, rectangular arrays, area models, addition/add, subtraction/subtract, (properties)-rules about how numbers work, reasoning.*

### **MGSE5.NBT.5 Fluently multiply multi-digit whole numbers using the standard algorithm (or other strategies demonstrating understanding of multiplication) up to a 3 digit by 2 digit factor.**

This standard refers to fluency which means accuracy (correct answer), efficiency (a reasonable amount of steps), and flexibility (using strategies such as the distributive property or breaking numbers apart also using strategies according to the numbers in the problem,  $26 \times 4$  may lend itself to  $(25 \times 4) + 4$  where as another problem might lend itself to making an equivalent problem  $32 \times 4 = 64 \times 2$ . This standard builds upon students' work with multiplying numbers in 3<sup>rd</sup> and 4<sup>th</sup> grade. In 4<sup>th</sup> grade, students developed understanding of multiplication through using various strategies. While the standard algorithm is mentioned, alternative strategies are also appropriate to help students develop conceptual understanding. The size of the numbers should NOT exceed a three-digit factor by a two-digit factor.

## Georgia Department of Education

Examples of alternative strategies:

There are 225 dozen cookies in the bakery. How many cookies are there?

<b>Student 1</b>  $225 \times 12$ I broke 12 up into 10 and 2.  $225 \times 10 = 2,250$ $225 \times 2 = 450$ $2,250 + 450 = 2,700$	<b>Student 2</b>  $225 \times 12$ I broke 225 up into 200 and 25.  $200 \times 12 = 2,400$ I broke 25 up into $5 \times 5$ , so I had $5 \times 5 \times 12$ or $5 \times 12 \times 5$ .  $5 \times 12 = 60$ $60 \times 5 = 300$ Then I added 2,400 and 300.  $2,400 + 300 = 2,700$	<b>Student 3</b>  I doubled 225 and cut 12 in half to get $450 \times 6$ . Then I doubled 450 again and cut 6 in half to $900 \times 3$ .  $900 \times 3 = 2,700$
---	---	---

Draw an array model for  $225 \times 12 \rightarrow 200 \times 10, 200 \times 2, 20 \times 10, 20 \times 2, 5 \times 10, 5 \times 2$ .

		<b>225 × 12</b>			
		<b>200</b>	<b>20</b>	<b>5</b>	
<b>10</b>	<b>2,000</b>	<b>200</b>	<b>50</b>		2,000
<b>2</b>	<b>400</b>	<b>40</b>	<b>10</b>		400
					200
					40
					50
					+ 10
					2,700

**MGSE5.NBT.6** Fluently divide up to 4-digit dividends and 2-digit divisors by using at least one of the following methods: strategies based on place value, the properties of operations, and/or the relationship between multiplication and division. Illustrate and explain the calculation by using equations or concrete models. (e.g., rectangular arrays, area models)

This standard references various strategies for division. Division problems can include remainders. Even though this standard leads more towards computation, the connection to story contexts is critical. Make sure students are exposed to problems where the divisor is the number of groups and where the divisor is the size of the groups. In 4<sup>th</sup> grade, students’ experiences with division were limited to dividing by one-digit divisors. This standard extends students’ prior experiences with strategies, illustrations, and explanations. When the two-digit divisor is a “familiar” number, a student might decompose the dividend using place value.

## Georgia Department of Education

Example:

There are 1,716 students participating in Field Day. They are put into teams of 16 for the competition. How many teams get created? If you have left over students, what do you do with them?

### Student 1

$$1,716 \div 16$$

There are 100 16's in 1,716.

$$1,716 - 1,600 = 116$$

I know there are at least 6 16's in 116.

$$116 - 96 = 20$$

I can take out one more 16.

$$20 - 16 = 4$$

There were 107 teams with 4 students left over. If we put the extra students on different teams, 4 teams will have 17 students.

### Student 2

$$1,716 \div 16$$

There are 100 16's in 1,716.

1,716	
- 1,600	100
116	
- 80	5
36	
- 32	2
4	

Ten groups of 16 is 160. That's too big. Half of that is 80, which is 5 groups.

I know that 2 groups of 16's is 32.

I have 4 students left over.

### Student 3

$$1,716 \div 16$$

I want to get to 1,716. I know that 100 16's equals 1,600. I know that 5 16's equals 80.

$$1,600 + 80 = 1,680$$

Two more groups of 16's equals 32, which gets us to 1,712. I am 4 away from 1,716.

So we had  $100 + 6 + 1 = 107$  teams.

Those other 4 students can just hang out.

### Student 4

How many 16's are in 1,716?

We have an area of 1,716. I know that one side of my array is 16 units long. I used 16 as the height. I am trying to answer the question: What is the width of my rectangle if the area is 1,716 and the height is 16?

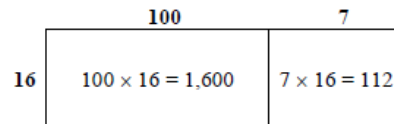

$$1,716 - 1,600 = 116$$

$$116 - 112 = 4$$

$$100 + 7 = 107 \text{ R } 4$$

## Georgia Department of Education

Examples:

- Using expanded notation:  $2682 \div 25 = (2000 + 600 + 80 + 2) \div 25$
- Using understanding of the relationship between 100 and 25, a student might think:
  - I know that 100 divided by 25 is 4 so 200 divided by 25 is 8 and 2000 divided by 25 is 80.
  - 600 divided by 25 has to be 24.
  - Since  $3 \times 25$  is 75, I know that 80 divided by 25 is 3 with a remainder of 5. (Note that a student might divide into 82 and not 80.)
  - I can't divide 2 by 25 so 2 plus the 5 leaves a remainder of 7.
  - $80 + 24 + 3 = 107$ . So, the answer is 107 with a remainder of 7.
- Using an equation that relates division to multiplication,  $25 \times n = 2682$ , a student might estimate the answer to be slightly larger than 100 because s/he recognizes that  $25 \times 100 = 2500$ .

Example:  $968 \div 21$

Using base ten models, a student can represent 962 and use the models to make an array with one dimension of 21. The student continues to make the array until no more groups of 21 can be made. Remainders are not part of the array.

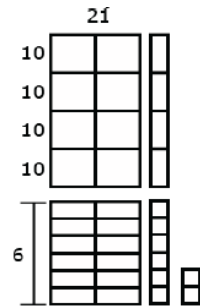

Example:  $9984 \div 64$

An area model for division is shown below. As the student uses the area model, s/he keeps track of how much of the 9984 is left to divide.

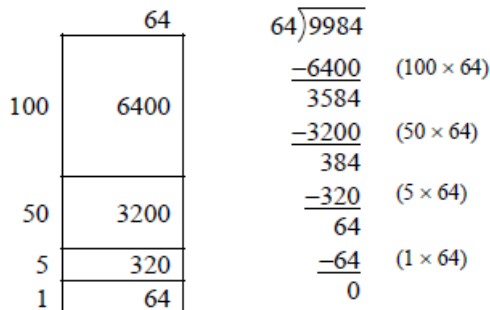

**MGSE5.NBT.7 Add, subtract, multiply, and divide decimals to hundredths, using concrete models or drawings and strategies based on place value, properties of operations, and/or the relationship between addition and subtraction; relate the strategy to a written method and explain the reasoning used.**

This standard builds on the work from 4<sup>th</sup> grade where students are introduced to decimals and compare them. In 5th grade, students begin adding, subtracting, multiplying and dividing

## Georgia Department of Education

decimals. This work should focus on concrete models and pictorial representations, rather than relying solely on the algorithm. The use of symbolic notations involves having students record the answers to computations ( $2.25 \times 3 = 6.75$ ), but this work should not be done without models or pictures. This standard includes students' reasoning and explanations of how they use models, pictures, and strategies.

This standard requires students to extend the models and strategies they developed for whole numbers in grades 1-4 to decimal values. Before students are asked to give exact answers, they should estimate answers based on their understanding of operations and the value of the numbers.

Examples:

- **+ 1.7**

A student might estimate the sum to be larger than 5 because 3.6 is more than  $3\frac{1}{2}$  and 1.7 is more than  $1\frac{1}{2}$ .

- **5.4 – 0.8**

A student might estimate the answer to be a little more than 4.4 because a number less than 1 is being subtracted.

- **$6 \times 2.4$**

A student might estimate an answer between 12 and 18 since  $6 \times 2$  is 12 and  $6 \times 3$  is 18. Another student might give an estimate of a little less than 15 because s/he figures the answer to be very close, but smaller than  $6 \times 2\frac{1}{2}$  and think of  $2\frac{1}{2}$  groups of 6 as 12 (2 groups of 6) +  $3(\frac{1}{2}$  of a group of 6).

Students should be able to express that when they add decimals they add tenths to tenths and hundredths to hundredths. So, when they are adding in a vertical format (numbers beneath each other), it is important that they write numbers with the same place value beneath each other. This understanding can be reinforced by connecting addition of decimals to their understanding of addition of fractions. Adding fractions with denominators of 10 and 100 is a standard in fourth grade.

Example:  $4 - 0.3$

3 tenths subtracted from 4 wholes. One of the wholes must be divided into tenths.



The solution is 3 and  $\frac{7}{10}$  or 3.7.

# Georgia Department of Education

Example:

A recipe for a cake requires 1.25 cups of milk, 0.40 cups of oil, and 0.75 cups of water.  
How much liquid is in the mixing bowl?

**Student 1:**  $1.25 + 0.40 + 0.75$

First, I broke the numbers apart. I broke 1.25 into  $1.00 + 0.20 + 0.05$ . I left 0.40 like it was. I broke 0.75 into  $0.70 + 0.05$ .

I combined my two 0.05's to get 0.10. I combined 0.40 and 0.20 to get 0.60. I added the 1 whole from 1.25. I ended up with 1 whole, 6 tenths, 7 more tenths, and another 1 tenths, so the total is 2.4.

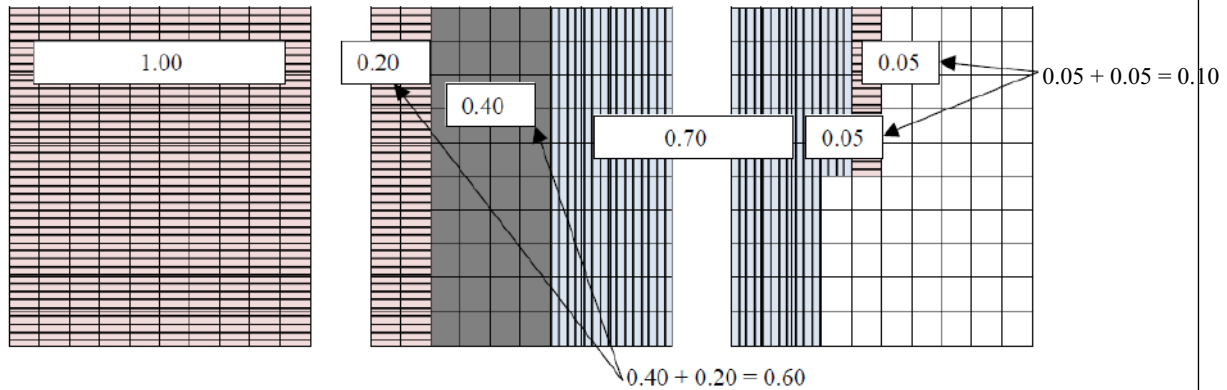

**Student 2**

I saw that the 0.25 in the 1.25 cups of milk and the 0.75 cups of water would combine to equal 1 whole cup. That plus the 1 whole in the 1.25 cups of milk gives me 2 whole cups. Then I added the 2 wholes and the 0.40 cups of oil to get 2.40 cups.

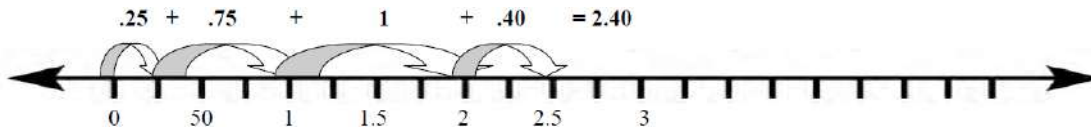

## Georgia Department of Education

### Example of Multiplication:

A gumball costs \$0.22. How much do 5 gumballs cost? Estimate the total, and then calculate. Was your estimate close?

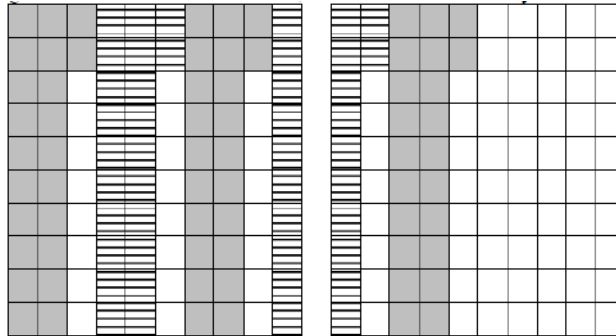

I estimate that the total cost will be a little more than a dollar. I know that 5 20's equal 100 and we have 5 22's. I have 10 whole columns shaded and 10 individual boxes shaded. The 10 columns equal 1 whole. The 10 individual boxes equal 10 hundredths or 1 tenth. My answer is \$1.10.

My estimate was a little more than a dollar, and my answer was \$1.10. I was really close.

### Example of Multiplication:

An area model can be useful for illustrating products.

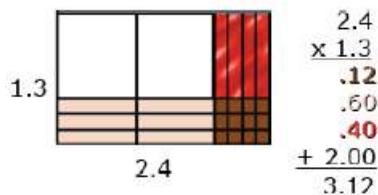

Students should be able to describe the partial products displayed by the area model.

For example, “ $\frac{3}{10}$  times  $\frac{4}{10}$  is  $\frac{12}{100}$ .”

$\frac{3}{10}$  times 2 is  $\frac{6}{10}$  or  $\frac{60}{100}$ .

1 group of  $\frac{4}{10}$  is  $\frac{4}{10}$  or  $\frac{40}{100}$ .

1 group of 2 is 2.”

**Example of Division:**

***Finding the number of groups***

Students could draw a segment to represent 1.6 meters. In doing so, s/he would count in tenths to identify the 6 tenths, and be able identify the number of 2 tenths within the 6 tenths. The student can then extend the idea of counting by tenths to divide the one meter into tenths and determine that there are 5 more groups of 2

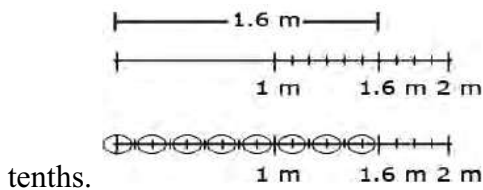

Students might count groups of 2 tenths without the use of models or diagrams. Knowing that 1 can be thought of as  $\frac{10}{10}$ , a student might think of 1.6 as 16 tenths. Counting 2 tenths, 4 tenths, 6 tenths, ..., 16 tenths, a student can count 8 groups of 2 tenths.

Use their understanding of multiplication and think, “8 groups of 2 is 16, so 8 groups of  $\frac{2}{10}$  is  $\frac{16}{10}$  or  $1\frac{6}{10}$ .”

**Example of Division:**

***Finding the number in each group or share***

Students should be encouraged to apply a fair sharing model separating decimal values into equal parts such as  $2.4 \div 4 = 0.6$ .

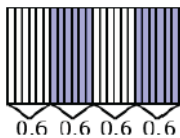

**Example of Division:**

***Finding the number of groups***

Joe has 1.6 meters of rope. He has to cut pieces of rope that are 0.2 meters long. How many can he cut?

**Example of Division:**

A relay race lasts 4.65 miles. The relay team has 3 runners. If each runner goes the same distance, how far does each team member run? Make an estimate, find your actual answer, and then compare them.



## Georgia Department of Education

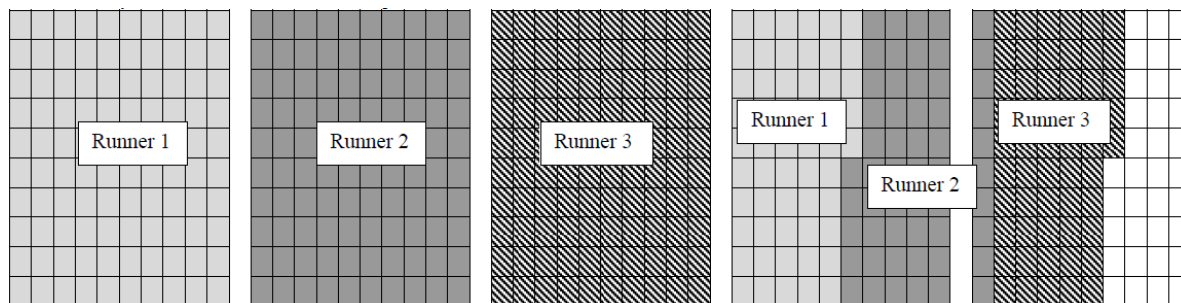

My estimate is that each runner runs between 1 and 2 miles. If each runner went 2 miles, that would be a total of 6 miles which is too high. If each runner ran 1 mile, that would be 3 miles, which is too low. I used the 5 grids above to represent the 4.65 miles. I am going to use all of the first 4 grids and 65 of the squares in the 5th grid. I have to divide the 4 whole grids and the 65 squares into 3 equal groups. I labeled each of the first 3 grids for each runner, so I know that each team member ran at least 1 mile. I then have 1 whole grid and 65 squares to divide up. Each column represents one-tenth. If I give 5 columns to each runner, that means that each runner has run 1 whole mile and 5 tenths of a mile. Now, I have 15 squares left to divide up. Each runner gets 5 of those squares. So each runner ran 1 mile, 5 tenths and 5 hundredths of a mile. I can write that as 1.55 miles.

My answer is 1.55 and my estimate was between 1 and 2 miles. I was pretty close.

### Common Misconceptions

Students might compute the sum or difference of decimals by lining up the right-hand digits as they would whole number. For example, in computing the sum of  $15.34 + 12.9$ , students will write the problem in this manner:

$$\begin{array}{r} 15.34 \\ + 12.9 \\ \hline 16.63 \end{array}$$

To help students add and subtract decimals correctly, have them first estimate the sum or difference. Providing students with a decimal-place value chart will enable them to place the digits in the proper place.

## NUMBER AND OPERATIONS - FRACTIONS

### MGSE CLUSTER #1: USE EQUIVALENT FRACTIONS AS A STRATEGY TO ADD AND SUBTRACT FRACTIONS.

*Students apply their understanding of fractions and fraction models to represent the addition and subtraction of fractions with unlike denominators as equivalent calculations with like denominators. They develop fluency in calculating sums and differences of fractions, and make reasonable estimates of them. Mathematically proficient students communicate precisely by engaging in discussion about their reasoning using appropriate mathematical language. The terms students should learn to use with increasing precision with this cluster are: **fraction**,*

## Georgia Department of Education

*equivalent, addition/ add, sum, subtraction/subtract, difference, unlike denominator, numerator, benchmark fraction, estimate, reasonableness, mixed numbers.*

### **MGSE5.NF.1 Add and subtract fractions and mixed numbers with unlike denominators by finding a common denominator and equivalent fractions to produce like denominators.**

This standard builds on the work in 4<sup>th</sup> grade where students add fractions with like denominators. In 5<sup>th</sup> grade, the example provided in the standard has students find a common denominator by finding the product of both denominators. For  $\frac{1}{3} + \frac{1}{6}$ , a common denominator is 18, which is the product of 3 and 6. This process should be introduced using visual fraction models (area models, number lines, etc.) to build understanding before moving into the standard algorithm.

Students should apply their understanding of equivalent fractions and their ability to rewrite fractions in an equivalent form to find common denominators. They should know that multiplying the denominators will always give a common denominator but may not result in the smallest denominator.

Examples:

$$\frac{2}{5} + \frac{7}{8} = \frac{16}{40} + \frac{35}{40} = \frac{51}{40}$$

$$3\frac{1}{4} - \frac{1}{6} = 3\frac{3}{12} - \frac{2}{12} = 3\frac{1}{12}$$

Example:

Present students with the problem  $\frac{1}{3} + \frac{1}{6}$ . Encourage students to use the clock face as a model for solving the problem. Have students share their approaches with the class and demonstrate their thinking using the clock model.

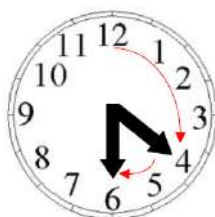

**MGSE5.NF.2 Solve word problems involving addition and subtraction of fractions, including cases of unlike denominators (e.g., by using visual fraction models or equations to represent the problem). Use benchmark fractions and number sense of fractions to estimate mentally and assess the reasonableness of answers. For example, recognize an incorrect result  $\frac{2}{5} + \frac{1}{2} = \frac{3}{7}$ , by observing that  $\frac{3}{7} < \frac{1}{2}$ .**

This standard refers to number sense, which means students' understanding of fractions as numbers that lie between whole numbers on a number line. Number sense in fractions also includes moving between decimals and fractions to find equivalents, also being able to use reasoning such as  $\frac{7}{8}$  is greater than  $\frac{3}{4}$  because  $\frac{7}{8}$  is missing only  $\frac{1}{8}$  and  $\frac{3}{4}$  is missing  $\frac{1}{4}$ , so  $\frac{7}{8}$  is

## Georgia Department of Education

closer to a whole Also, students should use benchmark fractions to estimate and examine the reasonableness of their answers. An example of using a benchmark fraction is illustrated with comparing  $\frac{5}{8}$  and  $\frac{6}{10}$ . Students should recognize that  $\frac{5}{8}$  is  $\frac{1}{8}$  larger than  $\frac{1}{2}$  (since  $\frac{1}{2} = \frac{4}{8}$ ) and  $\frac{6}{10}$  is  $\frac{1}{10}$  larger than  $\frac{1}{2}$  (since  $\frac{1}{2} = \frac{5}{10}$ ).

Example:

Your teacher gave you  $\frac{1}{7}$  of the bag of candy. She also gave your friend  $\frac{1}{3}$  of the bag of candy. If you and your friend combined your candy, what fraction of the bag would you have? Estimate your answer and then calculate. How reasonable was your estimate

### Student 1

$\frac{1}{7}$  is really close to 0.  $\frac{1}{3}$  is larger than  $\frac{1}{7}$  but still less than  $\frac{1}{2}$ . If we put them together we might get close to  $\frac{1}{2}$ .

$$\frac{1}{7} + \frac{1}{3} = \frac{3}{21} + \frac{7}{21} = \frac{10}{21}$$

The fraction  $\frac{10}{21}$  does not simplify, but I know that 10 is half of 20, so  $\frac{10}{21}$  is a little less than  $\frac{1}{2}$ .

### Student 2

$\frac{1}{7}$  is close to  $\frac{1}{6}$  but less than  $\frac{1}{6}$ .  $\frac{1}{3}$  is equivalent to  $\frac{2}{6}$ . So  $\frac{1}{7} + \frac{1}{3}$  is a little less than  $\frac{3}{6}$  or  $\frac{1}{2}$ .

Example:

Jerry was making two different types of cookies. One recipe needed  $\frac{3}{4}$  cup of sugar and the other needed  $\frac{2}{3}$  cup of sugar. How much sugar did he need to make both recipes?

- **Mental estimation:** A student may say that Jerry needs more than 1 cup of sugar but less than 2 cups. An explanation may compare both fractions to  $\frac{1}{2}$  and state that both are larger than  $\frac{1}{2}$  so the total must be more than 1. In addition, both fractions are slightly less than 1 so the sum cannot be more than 2.
- **Area model**

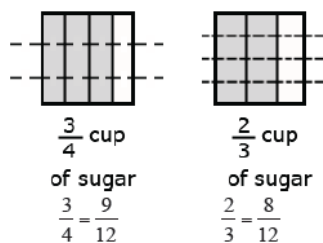

$$\frac{3}{4} + \frac{2}{3} = \frac{17}{12} = \frac{12}{12} + \frac{5}{12} = 1\frac{5}{12}$$

# Georgia Department of Education

- Linear model**

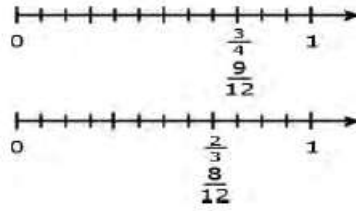

**Solution:**

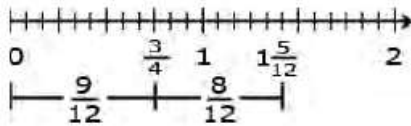

Examples: *Using a bar diagram*

- Sonia had  $2\frac{1}{3}$  candy bars. She promised her brother that she would give him  $\frac{1}{2}$  of a candy bar. How much will she have left after she gives her brother the amount she promised?



$\frac{7}{6}$  or  $1\frac{1}{6}$  bars  
for her brother

$\frac{7}{6}$  or  $1\frac{1}{6}$  bars  
for Sonia

- If Mary ran 3 miles every week for 4 weeks, she would reach her goal for the month. The first day of the first week she ran  $1\frac{3}{4}$  miles. How many miles does she still need to run the first week?



Distance to run every week: 3 miles



Distance run on  
1<sup>st</sup> day of the first week

Distance remaining to run  
during 1<sup>st</sup> week:  $1\frac{1}{4}$  miles

## Georgia Department of Education

Example: *Using an area model to subtract*

- This model shows  $1\frac{3}{4}$  subtracted from  $3\frac{1}{6}$  leaving  $1 + \frac{1}{4} + \frac{1}{6}$  which a student can then change to  $1 + \frac{3}{12} + \frac{2}{12} = 1\frac{5}{12}$ .

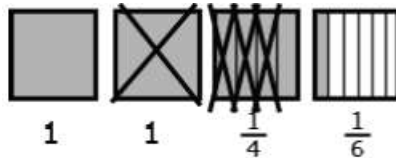

- This diagram models a way to show how  $3\frac{1}{6}$  and  $1\frac{3}{4}$  can be expressed with a denominator of 12. Once this is accomplished, a student can complete the problem,  $2\frac{14}{12} - 1\frac{9}{12} = 1\frac{5}{12}$ .

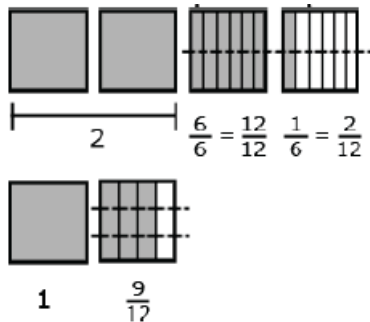

Estimation skills include identifying when estimation is appropriate, determining the level of accuracy needed, selecting the appropriate method of estimation, and verifying solutions or determining the reasonableness of situations using various estimation strategies. Estimation strategies for calculations with fractions extend from students' work with whole number operations and can be supported through the use of physical models.

Example:

Elli drank  $\frac{3}{5}$  quart of milk and Javier drank  $\frac{1}{10}$  of a quart less than Ellie. How much milk did they drink all together?

Solution:

$$\frac{3}{5} - \frac{1}{10} = \frac{6}{10} - \frac{1}{10} = \frac{5}{10}$$

$$\frac{3}{5} + \frac{5}{10} = \frac{6}{10} + \frac{5}{10} = \frac{11}{10}$$

This solution is reasonable because Ellie drank more than  $\frac{1}{2}$  quart and Javier drank  $\frac{1}{2}$  quart, so together they drank slightly more than one quart.

## Common Misconceptions

When solving problems that require renaming units, students use their knowledge of renaming the numbers as with whole numbers. Students need to pay attention to the unit of measurement which dictates the renaming and the number to use. The same procedures used in renaming whole numbers should not be taught when solving problems involving measurement conversions. For example, when subtracting 5 inches from 2 feet, students may take one foot from the 2 feet and use it as 10 inches. Since there were no inches with the 2 feet, they put 1 with 0 inches and make it 10 inches.

### **MGSE CLUSTER: #2 APPLY AND EXTEND PREVIOUS UNDERSTANDINGS OF MULTIPLICATION AND DIVISION TO MULTIPLY AND DIVIDE FRACTIONS.**

*Students also use the meaning of fractions, of multiplication and division, and the relationship between multiplication and division to understand and explain why the procedures for multiplying and dividing fractions make sense. (Note: this is limited to the case of dividing unit fractions by whole numbers and whole numbers by unit fractions.) Mathematically proficient students communicate precisely by engaging in discussion about their reasoning using appropriate mathematical language. The terms students should learn to use with increasing precision with this cluster are: **fraction, numerator, denominator, operations, multiplication/multiply, division/divide, mixed numbers, product, quotient, partition, equal parts, equivalent, factor, unit fraction, area, side lengths, fractional side lengths, scaling, comparing.***

**MGSE5.NF.3 Interpret a fraction as division of the numerator by the denominator ( $a/b = a \div b$ ). Solve word problems involving division of whole numbers leading to answers in the form of fractions or mixed numbers, e.g., by using visual fraction models or equations to represent the problem. Example:  $\frac{3}{5}$  can be interpreted as “3 divided by 5 and as 3 shared by 5”.**

This standard calls for students to extend their work of partitioning a number line from third and fourth grade. Students need ample experiences to explore the concept that a fraction is a way to represent the division of two quantities. Students are expected to demonstrate their understanding using concrete materials, drawing models, and explaining their thinking when working with fractions in multiple contexts. They read  $\frac{3}{5}$  as “three fifths” and after many experiences with sharing problems, learn that  $\frac{3}{5}$  can also be interpreted as “3 divided by 5.”

Examples:

1. Ten team members are sharing 3 boxes of cookies. How much of a box will each student get?  
When working this problem a student should recognize that the 3 boxes are being divided into 10 groups, so s/he is seeing the solution to the following equation,  $10 \times n = 3$  (10 groups of some amount is 3 boxes) which can also be written as  $n = \frac{3}{10}$

## Georgia Department of Education

÷ 10. Using models or diagram, they divide each box into 10 groups, resulting in each team member getting  $\frac{3}{10}$  of a box.

2. Two afterschool clubs are having pizza parties. For the Math Club, the teacher will order 3 pizzas for every 5 students. For the student council, the teacher will order 5 pizzas for every 8 students. Since you are in both groups, you need to decide which party to attend. How much pizza would you get at each party? If you want to have the most pizza, which party should you attend?
3. The six fifth grade classrooms have a total of 27 boxes of pencils. How many boxes will each classroom receive?  
Students may recognize this as a whole number division problem but should also express this equal sharing problem as  $\frac{27}{6}$ . They explain that each classroom gets  $\frac{27}{6}$  boxes of pencils and can further determine that each classroom get  $4\frac{3}{6}$  or  $4\frac{1}{2}$  boxes of pencils.
4. Your teacher gives 7 packs of paper to your group of 4 students. If you share the paper equally, how much paper does each student get?

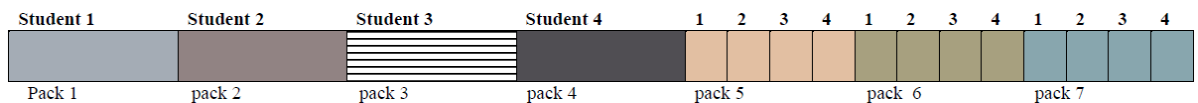

Each student receives 1 whole pack of paper and  $\frac{1}{4}$  of the each of the 3 packs of paper. So each student gets  $1\frac{3}{4}$  packs of paper.

### **MGSE5.NF.4 Apply and extend previous understandings of multiplication to multiply a fraction or whole number by a fraction.**

- a. **Apply and use understanding of multiplication to multiply a fraction or whole number by a fraction.**

*Examples:*  $\frac{a}{b} \times q$  as  $\frac{a}{b} \times \frac{q}{1}$  and  $\frac{a}{b} \times \frac{c}{d} = \frac{ac}{bd}$

Students need to develop a fundamental understanding that the multiplication of a fraction by a whole number could be represented as repeated addition of a unit fraction (e.g.,  $2 \times (\frac{1}{4}) = \frac{1}{4} + \frac{1}{4}$ ).

This standard extends student's work of multiplication from earlier grades. In 4<sup>th</sup> grade, students worked with recognizing that a fraction such as  $\frac{3}{5}$  actually could be represented as 3 pieces that are each one-fifth ( $3 \times \frac{1}{5}$ ). This standard references both the multiplication of a fraction by a whole number and the multiplication of two fractions.

Visual fraction models (area models, tape diagrams, number lines) should be used and created by students during their work with this standard.

As they multiply fractions such as  $\frac{3}{5} \times 6$ , they can think of the operation in more than one way.

$$3 \times (6 \div 5) \text{ or } (3 \times 6) \div 5$$

$$(3 \times 6) \div 5 \text{ or } 18 \div 5 \text{ (} 18/5 \text{)}$$

## Georgia Department of Education

Students create a story problem for  $\frac{3}{5} \times 6$  such as:

Isabel had 6 feet of wrapping paper. She used  $\frac{3}{5}$  of the paper to wrap some presents. How much does she have left?

Every day Tim ran  $\frac{3}{5}$  of mile. How far did he run after 6 days? (Interpreting this as  $6 \times \frac{3}{5}$ )

Example:

Three-fourths of the class is boys. Two-thirds of the boys are wearing tennis shoes. What fraction of the class are boys wearing tennis shoes?

This question is asking what is  $\frac{2}{3}$  of  $\frac{3}{4}$  what is  $\frac{2}{3} \times \frac{3}{4}$ ? In this case you have  $\frac{2}{3}$  groups of size  $\frac{3}{4}$ . (A way to think about it in terms of the language for whole numbers is by using an example such as  $4 \times 5$ , which means you have 4 groups of size 5.)

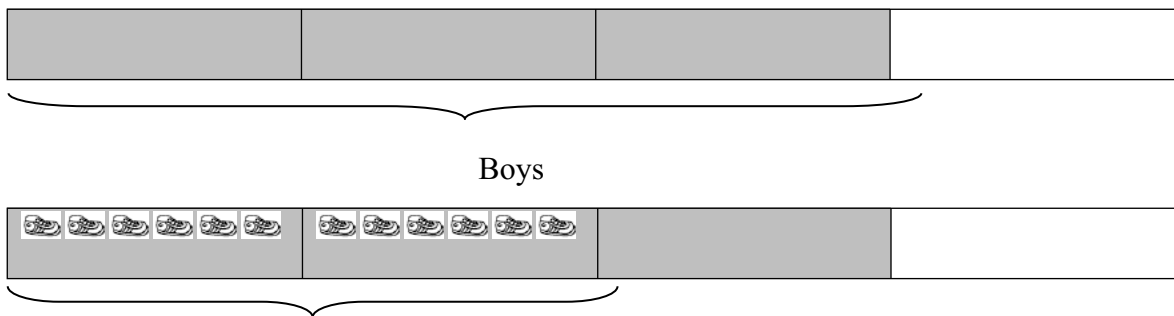

Boys wearing tennis shoes =  $\frac{1}{2}$  the class

The array model is very transferable from whole number work and then to binomials.

Additional student solutions are shown on the next page.

### Student 1

I drew rectangle to represent the whole class. The four columns represent the fourths of a class. I shaded 3 columns to represent the fraction that are boys. I then split the rectangle with horizontal lines into thirds.

The dark area represents the fraction of the boys in the class wearing tennis shoes, which is 6 out of 12. That is  $\frac{6}{12}$ , which equals  $\frac{1}{2}$ .

### Student 2

I used a fraction circle to model how I solved the problem. First I will shade the fraction circle to show the  $\frac{3}{4}$  and then overlay with  $\frac{2}{3}$  of that.

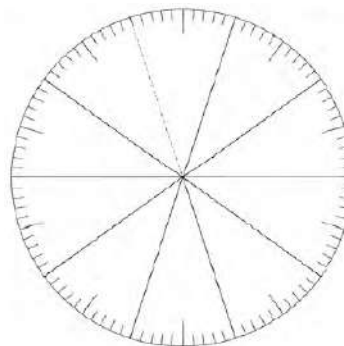



Georgia Department of Education

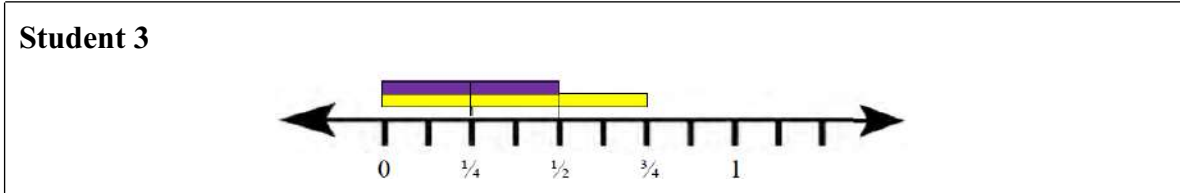
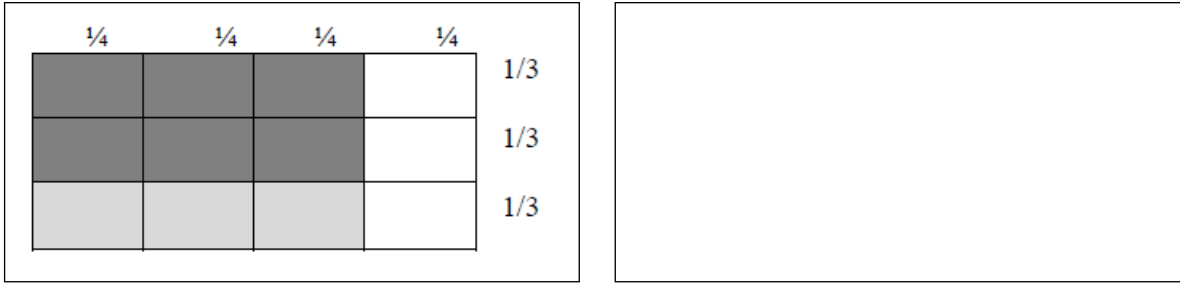

- b. Find the area of a rectangle with fractional side lengths by tiling it with unit squares of the appropriate unit fraction side lengths, and show that the area is the same as would be found by multiplying the side lengths.

This standard extends students’ work with area. In third grade students determine the area of rectangles and composite rectangles. In fourth grade students continue this work. The fifth grade standard calls students to continue the process of covering (with tiles). Grids (see picture) below can be used to support this work.

Example:

The home builder needs to cover a small storage room floor with carpet. The storage room is 4 meters long and half of a meter wide. How much carpet do you need to cover the floor of the storage room? Use a grid to show your work and explain your answer.

**Student**

In the grid below I shaded the top half of 4 boxes. When I added them together, I added  $\frac{1}{2}$  four times, which equals 2. I could also think about this with multiplication  $\frac{1}{2} \times 4$  is equal to  $\frac{4}{2}$  which is equal to 2.



Example:

In solving the problem  $\frac{2}{3} \times \frac{4}{5}$ , students use an area model to visualize it as a 2 by 4 array of small rectangles each of which has side lengths  $\frac{1}{3}$  and  $\frac{1}{5}$ . They reason that  $\frac{1}{3} \times \frac{1}{5} = \frac{1}{(3 \times 5)}$  by counting squares in the entire rectangle, so the area of the shaded area is  $(2 \times 4) \times \frac{1}{(3 \times 5)} = \frac{(2 \times 5)}{(3 \times 5)}$ . They can explain that the product is less than  $\frac{4}{5}$  because they are finding  $\frac{2}{3}$  of  $\frac{4}{5}$ . They can further estimate that the answer must be between  $\frac{2}{5}$  and  $\frac{4}{5}$  because of is more than  $\frac{1}{2}$  of  $\frac{4}{5}$  and less than one group of  $\frac{4}{5}$ .

## Georgia Department of Education

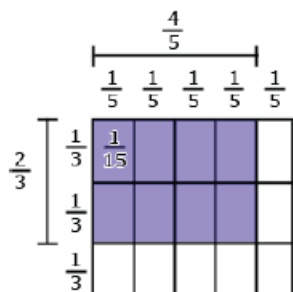

The area model and the line segments show that the area is the same quantity as the product of the side lengths.

### **MGSE5.NF.5 Interpret multiplication as scaling (resizing), by:**

- a. Comparing the size of a product to the size of one factor on the basis of the size of the other factor, without performing the indicated multiplication. Example:  $4 \times 10$  is twice as large as  $2 \times 10$ .**

This standard calls for students to examine the magnitude of products in terms of the relationship between two types of problems. This extends the work with MGSE5.OA.1.

**Example 1:**

Mrs. Jones teaches in a room that is 60 feet wide and 40 feet long. Mr. Thomas teaches in a room that is half as wide, but has the same length. How do the dimensions and area of Mr. Thomas' classroom compare to Mrs. Jones' room? Draw a picture to prove your answer.

**Example 2:**

How does the product of  $225 \times 60$  compare to the product of  $225 \times 30$ ? How do you know? Since 30 is half of 60, the product of  $225 \times 60$  will be double or twice as large as the product of  $225 \times 30$ .

**Example:**

$\frac{3}{4}$  is less than 7 because 7 is multiplied by a factor less than 1 so the product must be less than 7.

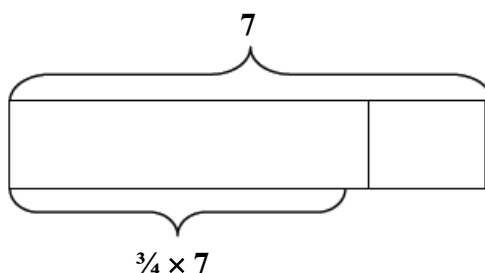

- b. Explaining why multiplying a given number by a fraction greater than 1 results in a product greater than the given number (recognizing multiplication by whole numbers greater than 1 as a familiar case); explaining why multiplying a given number by a fraction less than 1 results in a product smaller than the given number; and relating the principle of fraction equivalence  $a/b = (n \times a)/(n \times b)$  to the effect of multiplying  $a/b$  by 1**

## Georgia Department of Education

This standard asks students to examine how numbers change when we multiply by fractions. Students should have ample opportunities to examine both cases in the standard:

- when multiplying by a fraction greater than 1, the number increases and
- when multiplying by a fraction less than one, the number decreases. This standard should be explored and discussed while students are working with MGSE5.NF.4, and should not be taught in isolation.

Example:

Mrs. Bennett is planting two flower beds. The first flower bed is 5 meters long and  $\frac{6}{5}$  meters wide. The second flower bed is 5 meters long and  $\frac{5}{6}$  meters wide. How do the areas of these two flower beds compare? Is the value of the area larger or smaller than 5 square meters? Draw pictures to prove your answer.

Example:

$2\frac{2}{3} \times 8$  must be more than 8 because 2 groups of 8 is 16 and  $2\frac{2}{3}$  is almost 3 groups of 8. So the answer must be close to, but less than 24.

$\frac{3}{4} = \frac{(5 \times 3)}{(5 \times 4)}$  because multiplying  $\frac{3}{4}$  by  $\frac{5}{5}$  is the same as multiplying by 1

### **MGSE5.NF.6 Solve real world problems involving multiplication of fractions and mixed numbers, e.g., by using visual fraction models or equations to represent the problem.**

This standard builds on all of the work done in this cluster. Students should be given ample opportunities to use various strategies to solve word problems involving the multiplication of a fraction by a mixed number. This standard could include fraction by a fraction, fraction by a mixed number or mixed number by a mixed number.

Example:

There are  $2\frac{1}{2}$  bus loads of students standing in the parking lot. The students are getting ready to go on a field trip.  $\frac{2}{5}$  of the students on each bus are girls. How many busses would it take to carry *only* the girls?

#### **Student 1**

I drew 3 grids and 1 grid represents 1 bus. I cut the third grid in half and I marked out the right half of the third grid, leaving  $2\frac{1}{2}$  grids. I then cut each grid into fifths, and shaded two-fifths of each grid to represent the number of girls.

When I added up the shaded pieces,  $\frac{2}{5}$  of the 1<sup>st</sup> and 2<sup>nd</sup> bus were both shaded, and  $\frac{1}{5}$  of the last bus was shaded.

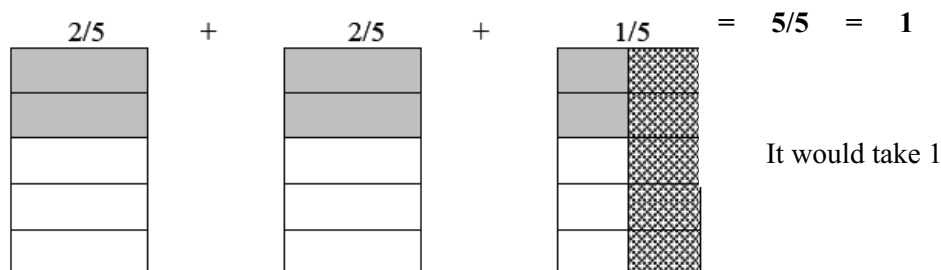



## Georgia Department of Education

by a fraction. The concept *unit fraction* is a fraction that has a one in the denominator. For example, the fraction  $\frac{3}{5}$  is 3 copies of the unit fraction  $\frac{1}{5}$ .  $\frac{1}{5} + \frac{1}{5} + \frac{1}{5} = \frac{3}{5} = \frac{1}{5} \times 3$  or  $3 \times \frac{1}{5}$ .

Example:

Knowing the number of groups/shares and finding how many/much in each group/share Four students sitting at a table were given  $\frac{1}{3}$  of a pan of brownies to share. How much of a pan will each student get if they share the pan of brownies equally?

The diagram shows the  $\frac{1}{3}$  pan divided into 4 equal shares with each share equaling  $\frac{1}{12}$  of the pan.

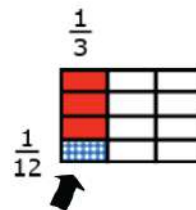

- a. Interpret division of a unit fraction by a non-zero whole number, and compute such quotients. For example, create a story context for  $(\frac{1}{3}) \div 4$ , and use a visual fraction model to show the quotient. Use the relationship between multiplication and division to explain that  $(\frac{1}{3}) \div 4 = \frac{1}{12}$  because  $(\frac{1}{12}) \times 4 = \frac{1}{3}$ .**

This standard asks students to work with story contexts where a unit fraction is divided by a non-zero whole number. Students should use various fraction models and reasoning about fractions.

Example:

You have  $\frac{1}{8}$  of a bag of pens and you need to share them among 3 people. How much of the bag does each person get?

### Student 1

I know I need to find the value of the expression  $\frac{1}{8} \div 3$ , and I want to use a number line.

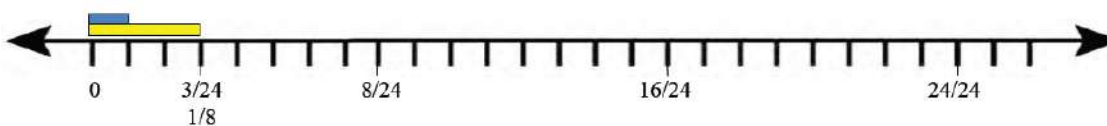

### Student 2

I drew a rectangle and divided it into 8 columns to represent my  $\frac{1}{8}$ . I shaded the first column. I then needed to divide the shaded region into 3 parts to represent sharing among 3 people. I shaded one-third of the first column even darker. The dark shade is  $\frac{1}{24}$  of the grid or  $\frac{1}{24}$  of the bag of pens.

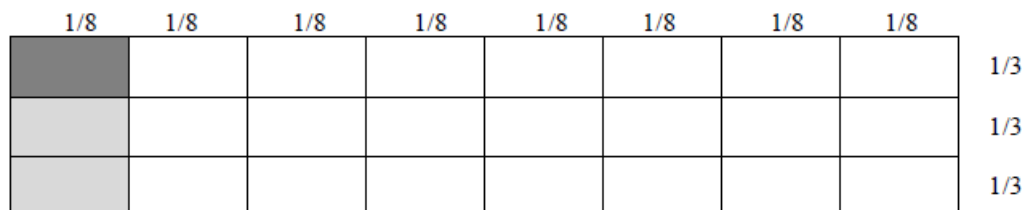

**Student 3**

$\frac{1}{8}$  of a bag of pens divided by 3 people. I know that my answer will be less than  $\frac{1}{8}$  since I'm sharing  $\frac{1}{8}$  into 3 groups. I multiplied 8 by 3 and got 24, so my answer is  $\frac{1}{24}$  of the bag of pens. I know that my answer is correct because  $(\frac{1}{24}) \times 3 = \frac{3}{24}$  which equals  $\frac{1}{8}$ .

- b. Interpret division of a whole number by a unit fraction, and compute such quotients.** *For example, create a story context for  $4 \div (\frac{1}{5})$ , and use a visual fraction model to show the quotient. Use the relationship between multiplication and division to explain that  $4 \div (\frac{1}{5}) = 20$  because  $20 \times (\frac{1}{5}) = 4$ .*

This standard calls for students to create story contexts and visual fraction models for division situations where a whole number is being divided by a unit fraction.

Example:

Create a story context for  $5 \div \frac{1}{6}$ . Find your answer and then draw a picture to prove your answer and use multiplication to reason about whether your answer makes sense. How many  $\frac{1}{6}$  are there in 5?

**Student**

The bowl holds 5 Liters of water. If we use a scoop that holds  $\frac{1}{6}$  of a Liter, how many scoops will we need in order to fill the entire bowl?

I created 5 boxes. Each box represents 1 Liter of water. I then divided each box into sixths to represent the size of the scoop. My answer is the number of small boxes, which is 30. That makes sense since  $6 \times 5 = 30$ .

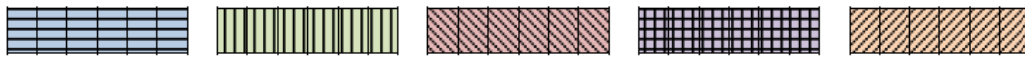

$1 = \frac{1}{6} + \frac{1}{6} + \frac{1}{6} + \frac{1}{6} + \frac{1}{6} + \frac{1}{6}$  a whole has  $\frac{6}{6}$  so five wholes would be  $\frac{6}{6} + \frac{6}{6} + \frac{6}{6} + \frac{6}{6} + \frac{6}{6} = \frac{30}{6}$ .

- c. Solve real world problems involving division of unit fractions by non-zero whole numbers and division of whole numbers by unit fractions, e.g., by using visual fraction models and equations to represent the problem.** *For example, how much chocolate will each person get if 3 people share  $\frac{1}{2}$  lb of chocolate equally? How many  $\frac{1}{3}$ -cup servings are 2 cups of raisins*

This standard extends students' work from other standards in MGSE5..NF.7. Student should continue to use visual fraction models and reasoning to solve these real-world problems.

Example:

How many  $\frac{1}{3}$ -cup servings are in 2 cups of raisins?

## Georgia Department of Education

**Student:**

I know that there are three  $\frac{1}{3}$  cup servings in 1 cup of raisins. Therefore, there are 6 servings in 2 cups of raisins. I can also show this since  $2 \div \frac{1}{3} = 2 \times 3 = 6$  servings of raisins.

Examples:

**Knowing how many in each group/share and finding how many groups/shares**

Angelo has 4 lbs of peanuts. He wants to give each of his friends  $\frac{1}{5}$  lb. How many friends can receive  $\frac{1}{5}$  lb of peanuts?

A diagram for  $4 \div \frac{1}{5}$  is shown below. Students explain that since there are five fifths in one whole, there must be 20 fifths in 4 lbs.

1 lb. of peanuts

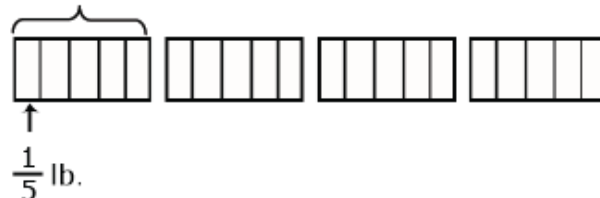

1. How much rice will each person get if 3 people share  $\frac{1}{2}$  lb of rice equally?
  - $\frac{1}{2} \div 3 = \frac{3}{6} \div 3 = \frac{1}{6}$
  - A student may think or draw  $\frac{1}{2}$  and cut it into 3 equal groups then determine that each of those part is  $\frac{1}{6}$ .
  - A student may think of  $\frac{1}{2}$  as equivalent to  $\frac{3}{6}$ .  $\frac{3}{6}$  divided by 3 is  $\frac{1}{6}$ .

## MEASUREMENT AND DATA

### MGSE CLUSTER #1: CONVERT LIKE MEASUREMENT UNITS WITHIN A GIVEN MEASUREMENT SYSTEM.

*Mathematically proficient students communicate precisely by engaging in discussion about their reasoning using appropriate mathematical language. The terms students should learn to use with increasing precision with this cluster are: **conversion/convert, metric and customary measurement** From previous grades: **relative size, liquid volume, mass, length, kilometer (km), meter (m), centimeter (cm), kilogram (kg), gram (g), liter (L), milliliter (mL), inch (in), foot (ft), yard (yd), mile (mi), ounce (oz), pound (lb), cup (c), pint (pt), quart (qt), gallon (gal), hour, minute, second***

**MGSE5.MD.1** Convert among different-sized standard measurement units (mass, weight, length, time, etc.) within a given measurement system (customary and metric) (e.g., convert 5cm to 0.05m), and use these conversions in solving multi-step, real word problems.

This standard calls for students to convert measurements within the same system of measurement in the context of multi-step, real-world problems. Both customary and standard measurement systems are included; students worked with both metric and

## Georgia Department of Education

customary units of length in second grade. In third grade, students work with metric units of mass and liquid volume. In fourth grade, students work with both systems and begin conversions within systems in length, mass and volume.

Students should explore how the base-ten system supports conversions within the metric system.

Example:  $100 \text{ cm} = 1 \text{ meter}$ .

### **MGSE CLUSTER #2: REPRESENT AND INTERPRET DATA.**

*Mathematically proficient students communicate precisely by engaging in discussion about their reasoning using appropriate mathematical language. The terms students should learn to use with increasing precision with this cluster are: **line plot, length, mass, liquid volume.***

**MGSE5. MD.2 Make a line plot to display a data set of measurements in fractions of a unit ( $\frac{1}{2}$ ,  $\frac{1}{4}$ ,  $\frac{1}{8}$ ). Use operations on fractions for this grade to solve problems involving information presented in line plots. For example, given different measurements of liquid in identical beakers, find the amount of liquid each beaker would contain if the total amount in all the beakers were redistributed equally.**

This standard provides a context for students to work with fractions by measuring objects to one-eighth of a unit. This includes length, mass, and liquid volume. Students are making a line plot of this data and then adding and subtracting fractions based on data in the line plot.

Example:

Students measured objects in their desk to the nearest  $\frac{1}{2}$ ,  $\frac{1}{4}$ , or  $\frac{1}{8}$  of an inch then displayed data collected on a line plot. How many objects measured  $\frac{1}{4}$ ?  $\frac{1}{2}$ ? If you put all the objects together end to end what would be the total length of **all** the objects?

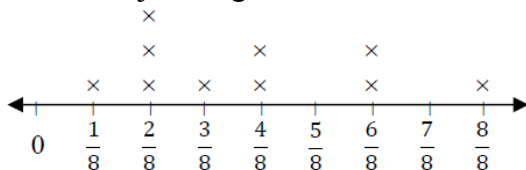

Example:

Ten beakers, measured in liters, are filled with a liquid.

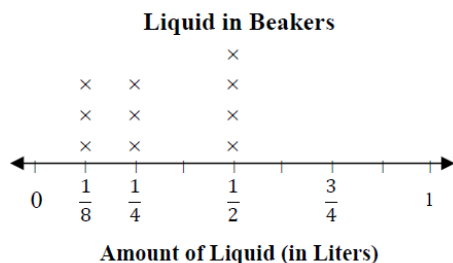

The line plot above shows the amount of liquid in liters in 10 beakers. If the liquid is redistributed equally, how much liquid would each beaker have? (This amount is the mean.)



## Georgia Department of Education

Students apply their understanding of operations with fractions. They use either addition and/or multiplication to determine the total number of liters in the beakers. Then the sum of the liters is shared evenly among the ten beakers.

### **MGSE CLUSTER #3: GEOMETRIC MEASUREMENT: UNDERSTAND CONCEPTS OF VOLUME AND RELATE VOLUME TO MULTIPLICATION AND TO ADDITION.**

*Students recognize volume as an attribute of three-dimensional space. They understand that volume can be measured by finding the total number of same size units of volume required to fill the space without gaps or overlaps. They understand that a 1-unit by 1-unit by 1-unit cube is the standard unit for measuring volume. They select appropriate units, strategies, and tools for solving problems that involve estimating and measuring volume. They decompose three-dimensional shapes and find volumes of right rectangular prisms by viewing them as decomposed into layers of arrays of cubes. They measure necessary attributes of shapes in order to determine volumes to solve real world and mathematical problems. Mathematically proficient students communicate precisely by engaging in discussion about their reasoning using appropriate mathematical language. The terms students should learn to use with increasing precision with this cluster are: **measurement, attribute, volume, solid figure, right rectangular prism, unit, unit cube, gap, overlap, cubic units (cubic cm, cubic in, cubic ft, nonstandard cubic units), multiplication, addition, edge lengths, height, area of base.***

**MGSE5.MD.3 Recognize volume as an attribute of solid figures and understand concepts of volume measurement.**

- a. A cube with side length 1 unit, called a “unit cube,” is said to have “one cubic unit” of volume, and can be used to measure volume.**
- b. A solid figure which can be packed without gaps or overlaps using  $n$  unit cubes is said to have a volume of  $n$  cubic units.**

**MGSE5.MD.4 Measure volumes by counting unit cubes, using cubic cm, cubic in, cubic ft, and improvised units.**

**MGSE5.MD.5 Relate volume to the operations of multiplication and addition and solve real world and mathematical problems involving volume.**

- a. Find the volume of a right rectangular prism with whole- number side lengths by packing it with unit cubes, and show that the volume is the same as would be found by multiplying the edge lengths, equivalently by multiplying the height by the area of the base. Represent threefold whole-number products as volumes, e.g., to represent the associative property of multiplication.**
- b. Apply the formulas  $V = l \times w \times h$  and  $V = b \times h$  for rectangular prisms to find volumes of right rectangular prisms with whole-number edge lengths in the context of solving real world and mathematical problems.**
- c. Recognize volume as additive. Find volumes of solid figures composed of two non-overlapping right rectangular prisms by adding the volumes of the non-overlapping parts, applying this technique to solve real world problems**

**Georgia Department of Education**

## Georgia Department of Education

**MGSE5.MD.3, MGSE5.MD.4, and MGSE5.MD.5:** *These standards represent the first time that students begin exploring the concept of volume. In third grade, students begin working with area and covering spaces. The concept of volume should be extended from area with the idea that students are covering an area (the bottom of cube) with a layer of unit cubes and then adding layers of unit cubes on top of bottom layer (see picture below). Students should have ample experiences with concrete manipulatives before moving to pictorial representations. Students' prior experiences with volume were restricted to liquid volume. As students develop their understanding volume they understand that a 1-unit by 1-unit by 1-unit cube is the standard unit for measuring volume. This cube has a length of 1 unit, a width of 1 unit and a height of 1 unit and is called a cubic unit. This cubic unit is written with an exponent of 3 (e.g.,  $\text{in}^3$ ,  $\text{m}^3$ ). Students connect this notation to their understanding of powers of 10 in our place value system. Models of cubic inches, centimeters, cubic feet, etc., are helpful in developing an image of a cubic unit. Students estimate how many cubic yards would be needed to fill the classroom or how many cubic centimeters would be needed to fill a pencil box.*

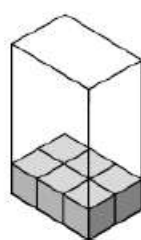
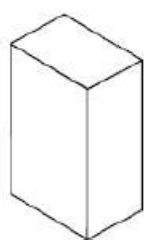

one layer

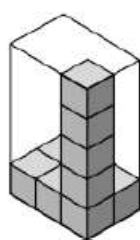

five layers  
fill the box

$(3 \times 2)$  represents the number of blocks in the first layer

$(3 \times 2) \times 5$  represents the number of blocks in 5 layers

$6 \times 5$  represents the number of block to fill the figure

30 blocks fill the figure

### **MGSE5.MD.5a and MGSE5.MD.5b:**

These standards involve finding the volume of right rectangular prisms. (See diagram below.) Students should have experiences to describe and reason about why the formula is true. Specifically, that they are covering the bottom of a right rectangular prism (length  $\times$  width) with multiple layers (height). Therefore, the formula (length  $\times$  width  $\times$  height) is an extension of the formula for the area of a rectangle.

### **MGSE5.MD.5c:**

This standard calls for students to extend their work with the area of composite figures into the context of volume. Students should be given concrete experiences of breaking apart (decomposing) 3-dimensional figures into right rectangular prisms in order to find the volume of the entire 3-dimensional figure.

Georgia Department of Education

Example:

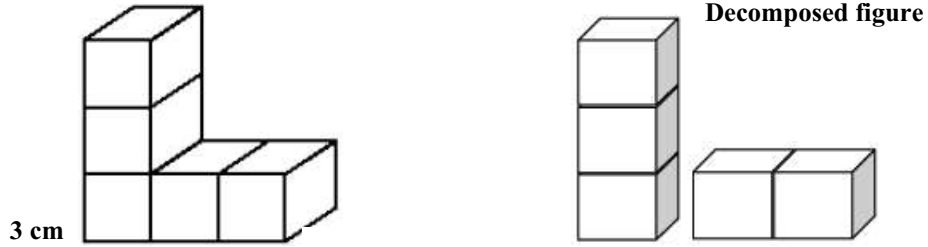

Example:

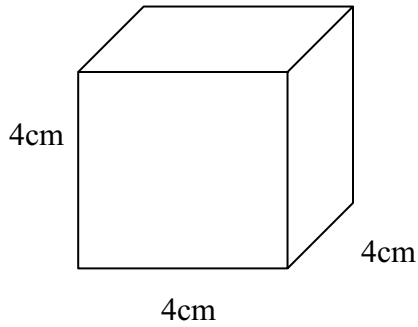

Example:

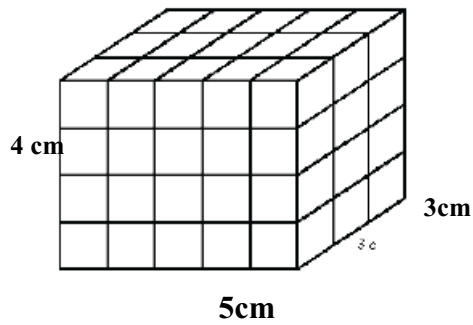

Students need multiple opportunities to measure volume by filling rectangular prisms with cubes and looking at the relationship between the total volume and the area of the base. They derive the volume formula (volume equals the area of the base times the height) and explore how this idea would apply to other prisms. Students use the associative property of multiplication and decomposition of numbers using factors to investigate rectangular prisms with a given number of cubic units.

## Georgia Department of Education

Example:

When given 24 cubes, students make as many rectangular prisms as possible with a volume of 24 cubic units. Students build the prisms and record possible dimensions.

Length	Width	Height
1	2	12
2	2	6
4	2	3
8	3	1

Example:

Students determine the volume of concrete needed to build the steps in the diagram at the right.

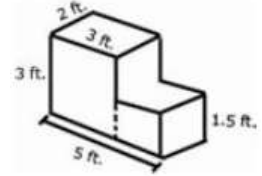

**GEOMETRY**

**MGSE CLUSTER #1: GRAPH POINTS ON THE COORDINATE PLANE TO SOLVE REAL-WORLD AND MATHEMATICAL PROBLEMS.**

*Mathematically proficient students communicate precisely by engaging in discussion about their reasoning using appropriate mathematical language. The terms students should learn to use with increasing precision with this cluster are: **coordinate system, coordinate plane, first quadrant, points, lines, axis/axes, x-axis, y-axis, horizontal, vertical, intersection of lines, origin, ordered pairs, coordinates, x-coordinate, y-coordinate.***

**MGSE5.G.1** Use a pair of perpendicular number lines, called axes, to define a coordinate system, with the intersection of the lines (the origin) arranged to coincide with the 0 on each line and a given point in the plane located by using an ordered pair of numbers, called its coordinates. Understand that the first number indicates how far to travel from the origin in the direction of one axis, and the second number indicates how far to travel in the direction of the second axis, with the convention that the names of the two axes and the coordinates correspond (e.g., x-axis and x-coordinate, y-axis and y-coordinate)

**MGSE5.G.2** Represent real world and mathematical problems by graphing points in the first quadrant of the coordinate plane, and interpret coordinate values of points in the context of the situation.

MGSE5.G.1 and MGSE5.G.2:

These standards deal with only the first quadrant (positive numbers) in the coordinate plane.

Example:

Connect these points in order on the coordinate grid at the right:

(2, 2) (2, 4) (2, 6) (2, 8) (4, 5) (6, 8) (6, 6) (6, 4) and (6, 2).

What letter is formed on the grid?

*Solution: "M" is formed.*

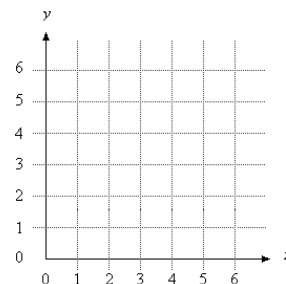

Example:

Plot these points on a coordinate grid.

- Point A: (2,6)
- Point B: (4,6)
- Point C: (6,3)
- Point D: (2,3)

Connect the points in order. Make sure to connect Point D back to Point A.

1. What geometric figure is formed? What attributes did you use to identify it?

## Georgia Department of Education

2. What line segments in this figure are parallel?
3. What line segments in this figure are perpendicular?

*Solutions:*

1. *Trapezoid*
2. *line segments AB and DC are parallel*
3. *segments AD and DC are perpendicular*

**Example:**

Emanuel draws a line segment from (1, 3) to (8, 10). He then draws a line segment from (0, 2) to (7, 9). If he wants to draw another line segment that is parallel to those two segments what points will he use?

This standard references real-world and mathematical problems, including the traveling from one point to another and identifying the coordinates of missing points in geometric figures, such as squares, rectangles, and parallelograms.

**Example:**

Using the coordinate grid, which ordered pair represents the location of the school? Explain a possible path from the school to the library.

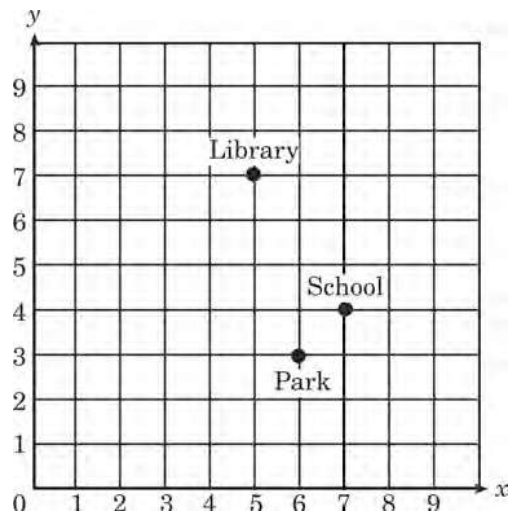

## Georgia Department of Education

Example:

Sara has saved \$20. She earns \$8 for each hour she works.

1. If Sara saves all of her money, how much will she have after working each of the following
  - a. 3 hours?
  - b. 5 hours?
  - c. 10 hours?
2. Create a graph that shows the relationship between the hours Sara worked and the amount of money she has saved.
3. What other information do you know from analyzing the graph?

Example:

Use the graph below to determine how much money Jack makes after working exactly 9 hours.

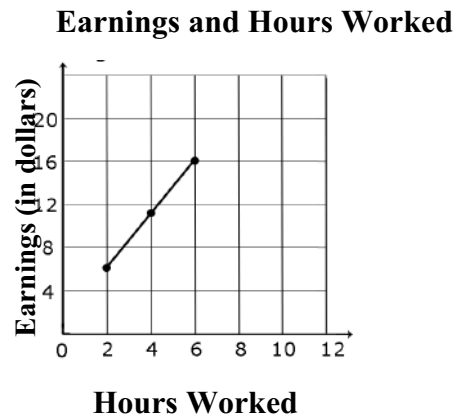

### Common Misconceptions

When playing games with coordinates or looking at maps, students may think the order in plotting a coordinate point is not important. Have students plot points so that the position of the coordinates is switched. For example, have students plot (3, 4) and (4, 3) and discuss the order used to plot the points. Have students create directions for others to follow so that they become aware of the importance of direction and distance.



**MGSE CLUSTER #2: CLASSIFY TWO-DIMENSIONAL FIGURES INTO CATEGORIES BASED ON THEIR PROPERTIES.**

*Mathematically proficient students communicate precisely by engaging in discussion about their reasoning using appropriate mathematical language. The terms students should learn to use with increasing precision with this cluster are: attribute, category, subcategory, hierarchy, (properties)-rules about how numbers work, two-dimensional. From previous grades: **polygon, rhombus/rhombi, rectangle, square, triangle, quadrilateral, pentagon, hexagon, cube and trapezoid.***

**MGSE5.G.3 Understand that attributes belonging to a category of two-dimensional figures also belong to all subcategories of that category. For example, all rectangles have four right angles and squares are rectangles, so all squares have four right angles**

This standard calls for students to reason about the attributes (properties) of shapes. Students should have experiences discussing the property of shapes and reasoning.

Example:

Examine whether all quadrilaterals have right angles. Give examples and non-examples.

Examples of questions that might be posed to students:

- If the opposite sides on a figure are parallel and congruent, then the figure is a rectangle. True or false?
- A parallelogram has 4 sides with both sets of opposite sides parallel. What types of quadrilaterals are parallelograms?
- Regular polygons have all of their sides and angles congruent. Name or draw some regular polygons.
- All rectangles have 4 right angles. Squares have 4 right angles so they are also rectangles. True or False?
- A trapezoid has at least 2 sides parallel so it must be a parallelogram. True or False?

**MGSE5.G.4 Classify two-dimensional figures in a hierarchy based on properties (*polygons, triangles, and* ).**

This standard builds on what was done in 4<sup>th</sup> grade. Figures from previous grades: polygon, rhombus/rhombi, rectangle, square, triangle, quadrilateral, pentagon, hexagon, cube, trapezoid, half/quarter circle, circle

## Georgia Department of Education

Example:

Create a hierarchy diagram using the following terms.

- polygons – a closed plane figure formed from line segments that meet only at their endpoints
  - quadrilaterals - a four-sided polygon
  - rectangles - a quadrilateral with two pairs of congruent parallel sides and four right angles .
  - rhombi – a parallelogram with all four sides equal in length.
  - square – a parallelogram with four congruent sides and four right angles.
- 
- quadrilateral – a four-sided polygon.
  - parallelogram – a quadrilateral with two pairs of parallel and congruent sides.
  - rectangle – a quadrilateral with two pairs of congruent, parallel sides and four right angles
  - rhombus – a parallelogram with all four sides equal in length
  - square – a parallelogram with four congruent sides and four right angles.

*Possible student solution:*

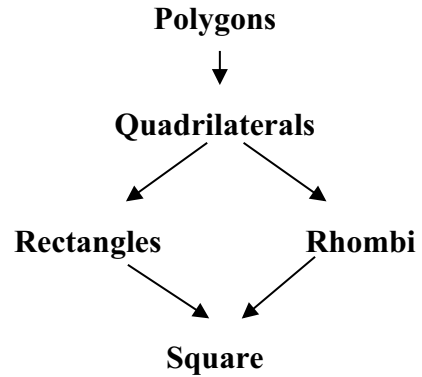

*Possible student solution:*

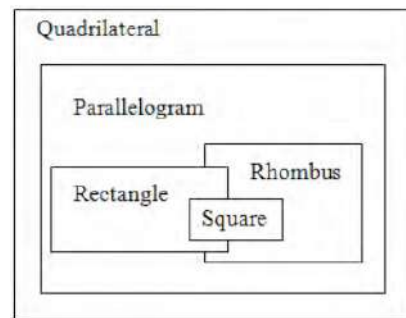

Student should be able to reason about the attributes of shapes by examining questions like the following.

- What are ways to classify triangles?
- Which quadrilaterals have opposite angles congruent and why is this true of certain quadrilaterals?
- How many lines of symmetry does a regular polygon have?

### Common Misconceptions

Students think that when describing geometric shapes and placing them in subcategories, the last category is the only classification that can be used.

## MINDSET AND MATHEMATICS

**Growth mindset was pioneered by Carol Dweck, Lewis and Virginia Eaton Professor of Psychology at Stanford University.** She and her colleagues were the first to identify a link between growth mindset and achievement. They found that students who believed that their ability and intelligence could grow and change, otherwise known as growth mindset, outperformed those who thought that their ability and intelligence were fixed. Additionally, students who were taught that they could grow their intelligence actually did better over time. Dweck's research showed that an increased focus on the process of learning, rather than the outcome, helped increase a student's growth mindset and ability.

(from [WITH+MATH=I CAN](#))

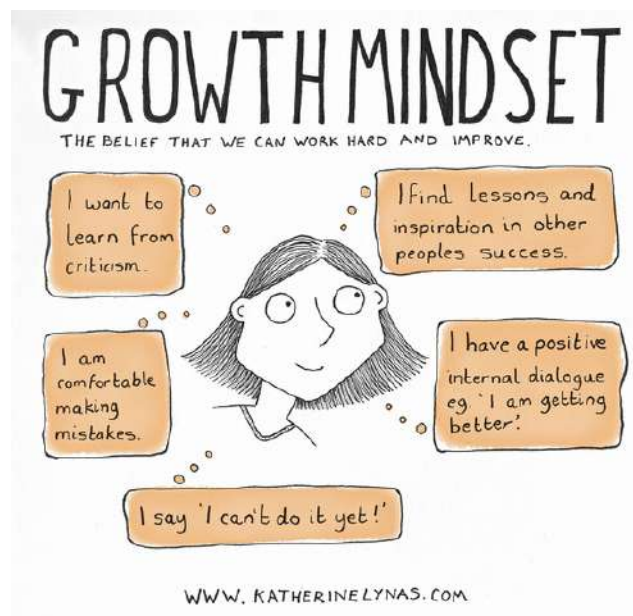

**Jo Boaler, Professor of Mathematics Education** at the Stanford Graduate School of Education and author of *Mathematical Mindsets: Unleashing Students' Potential through Creative Math, Inspiring Messages, and Innovative Teaching*, was one of the first to apply growth mindset to math achievement.

You can learn how to use the power of growth mindset for yourself and your students here:

<https://www.amazon.com/gp/withmathican>

<https://www.mindsetkit.org/topics/about-growth-mindset>

<https://www.youcubed.org/>

*Growth and Fixed Mindset images courtesy of Katherine Lynas (katherinelynas.com). Thank you, Katherine!*

## Georgia Department of Education

### VERTICAL UNDERSTANDING OF THE MATHEMATICS LEARNING TRAJECTORY

Why does it matter if you know what happens in mathematics in the grades before and after the one you teach? Isn't it enough just to know and understand the expectations for your grade?

There are many reasons to devote a bit of your time to the progression of standards.

You'll:

- Deepen your understanding of how development of algebraic thinking has proven to be a critical element of student mathematics success as they transition from elementary to middle school. Elementary and middle school teachers must understand how algebraic thinking develops prior to their grade, in their grade, and beyond their grade in order to support student algebraic thinking
- Know what to expect when students show up in your grade because you know what they should understand from the years before
- Understand how conceptual understanding develops, making it easier to help students who have missing bits and pieces
- Be able to help students to see the connections between ideas in mathematics in your grade and beyond, helping them to connect to what they already know and what is to come
- Assess understanding more completely, and develop better assessments
- Know what the teachers in the grades to come expect your students to know and understand
- Plan more effectively with same-grade and other-grade colleagues
- Deepen your understanding of the mathematics of your grade

We aren't asking you to take a month off to study up, just asking that you reference the following resources when you want to deepen your understanding of where students are in their mathematics learning, understand why they are learning what they are learning in your grade, and understand the mathematical ideas and connections within your grade and beyond.

#### **Resources:**

##### **The Coherence Map:**

<http://achievethecore.org/page/1118/coherence-map> This resource diagrams the connections between standards, provides explanations of standards, provides example tasks for many standards, and links to the progressions document when further detail is required.

##### **A visual learning trajectory of:**

Addition and Subtraction - <http://gfletchy.com/2016/03/04/the-progression-of-addition-and-subtraction/>

Multiplication - <http://gfletchy.com/2015/12/18/the-progression-of-multiplication/>

Division - <http://gfletchy.com/2016/01/31/the-progression-of-division/>

(Many thanks to Graham Fletcher, the genius behind these videos)

## Georgia Department of Education

### The Mathematics Progression Documents:

<http://math.arizona.edu/~ime/progressions/>

### Learning Trajectories in Mathematics:

[http://www.cpre.org/images/stories/cpre\\_pdfs/learning%20trajectories%20in%20math\\_ccii%20report.pdf](http://www.cpre.org/images/stories/cpre_pdfs/learning%20trajectories%20in%20math_ccii%20report.pdf)

### RESEARCH OF INTEREST TO MATHEMATICS TEACHERS:

Social Emotional Learning and Math-

[http://curry.virginia.edu/uploads/resourceLibrary/Teachers\\_support\\_for\\_SEL\\_contributes\\_to\\_improved\\_math\\_teaching\\_and\\_learning\\_et\\_al.pdf](http://curry.virginia.edu/uploads/resourceLibrary/Teachers_support_for_SEL_contributes_to_improved_math_teaching_and_learning_et_al.pdf)

Why how you teach math is important - <https://www.youcubed.org/>

### GLOSS AND IKAN

GloSS and IKAN information can be found here: <http://ccgpsmathematics6-8.wikispaces.com/GLoSS+%26+IKAN> While this page is on the 6-8 math wiki, the information provided is useful to teachers of grades K-8.

The GloSS and IKAN professional learning video found here:

<https://www.georgiastandards.org/Georgia-Standards/Pages/FOA/Foundations-of-Algebra-Day-1.aspx> provides an in-depth look at the GloSS and IKAN. While it was created for teachers of Foundations of Algebra, the information is important for teachers of grades K- 12.

The GloSS and IKAN prezi found on georgiastandards.org, here:

<https://www.georgiastandards.org/Georgia-Standards/Pages/Global-Strategy-Stage-GloSS-and-Individual-Knowledge-Assessment-of-Number-IKAN.aspx>

### FLUENCY

**Fluency:** Procedural fluency is defined as skill in carrying out procedures flexibly, accurately, efficiently, and appropriately. Fluent problem solving does not necessarily mean solving problems within a certain time limit, though there are reasonable limits on how long computation should take. Fluency is based on a deep understanding of quantity and number.

**Deep Understanding:** Teachers teach more than simply “how to get the answer” and instead support students’ ability to access concepts from a number of perspectives. Therefore students are able to see math as more than a set of mnemonics or discrete procedures. Students demonstrate deep conceptual understanding of foundational mathematics concepts by applying them to new situations, as well as writing and speaking about their understanding.

**Memorization:** The rapid recall of arithmetic facts or mathematical procedures. Memorization is often confused with fluency. Fluency implies a much richer kind of mathematical knowledge and experience.

## Georgia Department of Education

**Number Sense:** Students consider the context of a problem, look at the numbers in a problem, make a decision about which strategy would be most efficient in each particular problem. Number sense is not a deep understanding of a single strategy, but rather the ability to think flexibly between a variety of strategies in context.

### **Fluent students:**

- flexibly use a combination of deep understanding, number sense, and memorization.
- are fluent in the necessary baseline functions in mathematics so that they are able to spend their thinking and processing time unpacking problems and making meaning from them.
- are able to articulate their reasoning.
- find solutions through a number of different paths.

For more about fluency, see: <http://www.youcubed.org/wp-content/uploads/2015/03/FluencyWithoutFear-2015.pdf> and: <https://bhi61nm2cr3mkgk1dtaov18-wpengine.netdna-ssl.com/wp-content/uploads/nctm-timed-tests.pdf>

### **ARC OF LESSON (OPENING, WORK SESSION, CLOSING)**

“When classrooms are workshops-when learners are inquiring, investigating, and constructing- there is already a feeling of community. In workshops learners talk to one another, ask one another questions, collaborate, prove, and communicate their thinking to one another. The heart of math workshop is this: investigations and inquiries are ongoing, and teachers try to find situations and structure contexts that will enable children to mathematize their lives- that will move the community toward the horizon. Children have the opportunity to explore, to pursue inquiries, and to model and solve problems on their own creative ways. Searching for patterns, raising questions, and constructing one’s own models, ideas, and strategies are the primary activities of math workshop. The classroom becomes a community of learners engaged in activity, discourse, and reflection.” *Young Mathematicians at Work - Constructing Addition and Subtraction*, by Catherine Twomey Fosnot and Maarten Dolk.

“Students must believe that the teacher does not have a predetermined method for solving the problem. If they suspect otherwise, there is no reason for them to take risks with their own ideas and methods.” *Teaching Student-Centered Mathematics, K-3* by John Van de Walle and Lou Ann Lovin.

### **Opening: Set the stage**

Get students mentally ready to work on the task

Clarify expectations for products/behavior

How?

- Begin with a simpler version of the task to be presented
- Solve problem strings related to the mathematical idea/s being investigated
- Leap headlong into the task and begin by brainstorming strategies for approaching the task
- Estimate the size of the solution and reason about the estimate

Richard Woods, State School Superintendent

July 2016 • Page 54 of 75

All Rights Reserved

## Georgia Department of Education

Make sure everyone understands the task before beginning. Have students restate the task in their own words. Every task should require more of the students than just the answer.

### **Work session: Give ‘em a chance**

Students- grapple with the mathematics through sense-making, discussion, concretizing their mathematical ideas and the situation, record thinking in journals

Teacher- Let go. Listen. Respect student thinking. Encourage testing of ideas. Ask questions to clarify or provoke thinking. Provide gentle hints. Observe and assess.

### **Closing: Best Learning Happens Here**

Students- share answers, justify thinking, clarify understanding, explain thinking, question each other

Teacher- Listen attentively to all ideas, ask for explanations, offer comments such as, “Please tell me how you figured that out.” “I wonder what would happen if you tried...”

Anchor charts

### **Read Van de Walle K-3, Chapter 1**

## **BREAKDOWN OF A TASK (UNPACKING TASKS)**

How do I go about tackling a task or a unit?

1. Read **the unit** in its entirety. Discuss it with your grade level colleagues. Which parts do you feel comfortable with? Which make you wonder? Brainstorm ways to implement the tasks. Collaboratively complete the culminating task with your grade level colleagues. As students work through the tasks, you will be able to facilitate their learning with this end in mind. The structure of the units/tasks is similar task to task and grade to grade. This structure allows you to converse in a vertical manner with your colleagues, school-wide. There is a great deal of mathematical knowledge and teaching support within each grade level guide, unit, and task.
2. Read **the first task** your students will be engaged in. Discuss it with your grade level colleagues. Which parts do you feel comfortable with? Which make you wonder? Brainstorm ways to implement the task.
3. If not already established, use the first few weeks of school to establish routines and rituals, and to assess student mathematical understanding. You might use some of the tasks found in the unit, or in some of the following resources as beginning tasks/centers/math tubs which serve the dual purpose of allowing you to observe and assess.

Additional Resources:

Math Their Way: <http://www.center.edu/MathTheirWay.shtml>

NZMaths- [http://www.nzmaths.co.nz/numeracy-development-projects-books?parent\\_node=](http://www.nzmaths.co.nz/numeracy-development-projects-books?parent_node=)

K-5 Math Teaching Resources- <http://www.k-5mathteachingresources.com/index.html>  
(this is a for-profit site with several free resources)

## Georgia Department of Education

Math Solutions- <http://www.mathsolutions.com/index.cfm?page=wp9&crd=56>

#### 4. Points to remember:

- Each task begins with a list of the standards specifically addressed in that task, however, that does not mean that these are the only standards addressed in the task. Remember, standards build on one another, and mathematical ideas are connected.
- Tasks are made to be modified to match your learner’s needs. If the names need changing, change them. If the materials are not available, use what is available. If a task doesn’t go where the students need to go, modify the task or use a different resource.
- The units are not intended to be all encompassing. Each teacher and team will make the units their own, and add to them to meet the needs of the learners.

### **ROUTINES AND RITUALS**

#### **Teaching Math in Context and Through Problems**

“By the time they begin school; most children have already developed a sophisticated, informal understanding of basic mathematical concepts and problem solving strategies. Too often, however, the mathematics instruction we impose upon them in the classroom fails to connect with this informal knowledge” (Carpenter et al., 1999). The 8 Standards of Mathematical Practices (SMP) should be at the forefront of every mathematics lessons and be the driving factor of HOW students learn.

One way to help ensure that students are engaged in the 8 SMPs is to construct lessons built on context or through story problems. It is important for you to understand the difference between story problems and context problems. “Fosnot and Dolk (2001) point out that in story problems children tend to focus on getting the answer, probably in a way that the teacher wants. “Context problems, on the other hand, are connected as closely as possible to children’s lives, rather than to ‘school mathematics’. They are designed to anticipate and develop children’s mathematical modeling of the real world.”

Traditionally, mathematics instruction has been centered around many problems in a single math lesson, focusing on rote procedures and algorithms which do not promote conceptual understanding. Teaching through word problems and in context is difficult however; there are excellent reasons for making the effort.

- Problem solving focuses students’ attention on ideas and sense making
  - Problem solving develops the belief in students that they are capable of doing the mathematics and that mathematics makes sense
  - Problem solving provides on going assessment data
  - Problem solving is an excellent method for attending to a breadth of abilities
  - Problem solving engages students so that there are few discipline problems
  - Problem solving develops “mathematical power”
- (Van de Walle 3-5 pg. 15 and 16)



## Georgia Department of Education

A *problem* is defined as any task or activity for which the students have no prescribed or memorized rules or methods, nor is there a perception by students that there is a specific correct solution method. A problem for learning mathematics also has these features:

- *The problem must begin where the students are, which makes it accessible to all learners.*
- *The problematic or engaging aspect of the problem must be due to the mathematics that the students are to learn.*
- *The problem must require justifications and explanations for answers and methods.*

It is important to understand that mathematics is to be taught *through* problem solving. That is, problem-based tasks or activities are the vehicle through which the standards are taught. Student learning is an outcome of the problem-solving process and the result of teaching within context and through the Standards for Mathematical Practice. (Van de Walle and Lovin, Teaching Student-Centered Mathematics: 3-5 pg. 11 and 12)

### **Use of Manipulatives**

Used correctly manipulatives can be a positive factor in children's learning. It is important that you have a good perspective on how manipulatives can help or fail to help children construct ideas." (Van de Walle and Lovin, Teaching Student-Centered Mathematics: 3-5 pg. 6)

When a new model of new use of a familiar model is introduced into the classroom, it is generally a good idea to explain how the model is used and perhaps conduct a simple activity that illustrates this use.

Once you are comfortable that the models have been explained, you should not force their use on students. Rather, students should feel free to select and use models that make sense to them. In most instances, not using a model at all should also be an option. The choice a student makes can provide you with valuable information about the level of sophistication of the student's reasoning.

Whereas the free choice of models should generally be the norm in the classroom, you can often ask students to model to show their thinking. This will help you find out about a child's understanding of the idea and also his or her understanding of the models that have been used in the classroom.

The following are simple rules of thumb for using models:

- Introduce new models by showing how they can represent the ideas for which they are intended.
- Allow students (in most instances) to select freely from available models to use in solving problems.
- Encourage the use of a model when you believe it would be helpful to a student having difficulty. (Van de Walle and Lovin, Teaching Student-Centered Mathematics 3-5 pg. 9)
- Modeling also includes the use of mathematical symbols to represent/model the concrete mathematical idea/thought process/situation. This is a very important, yet often neglected step along the way. Modeling can be concrete, representational, and abstract. Each type of model is important to student understanding. Modeling also means to "mathematize" a

## Georgia Department of Education

situation or problem, to take a situation which might at first glance not seem mathematical, and view it through the lens of mathematics. For example, students notice that the cafeteria is always out of their favorite flavor of ice cream on ice cream days. They decide to survey their schoolmates to determine which flavors are most popular, and share their data with the cafeteria manager so that ice cream orders reflect their findings. The problem: Running out of ice cream flavors. The solution: Use math to change the flavor amounts ordered.

### **Use of Strategies and Effective Questioning**

Teachers ask questions all the time. They serve a wide variety of purposes: to keep learners engaged during an explanation; to assess their understanding; to deepen their thinking or focus their attention on something. This process is often semi-automatic. Unfortunately, there are many common pitfalls. These include:

- asking questions with no apparent purpose;
- asking too many closed questions;
- asking several questions all at once;
- poor sequencing of questions;
- asking rhetorical questions;
- asking ‘Guess what is in my head’ questions;
- focusing on just a small number of learners;
- ignoring incorrect answers;
- not taking answers seriously.

In contrast, the research shows that effective questioning has the following characteristics:

- Questions are planned, well ramped in difficulty.
- Open questions predominate.
- A climate is created where learners feel safe.
- A ‘no hands’ approach is used, for example when all learners answer at once using mini-whiteboards, or when the teacher chooses who answers.
- Probing follow-up questions are prepared.
- There is a sufficient ‘wait time’ between asking and answering a question.
- Learners are encouraged to collaborate before answering.
- Learners are encouraged to ask their own questions.

### **Number Lines**

The use of number lines in elementary mathematics is crucial in students’ development of number and mathematical proficiency. While the CCGPS explicitly state use number lines in grades 2-5, number lines should be used in all grade levels and in multiple settings.

According to John Van de Walle,

A number line is also a worthwhile model, but can initially present conceptual difficulties for children below second grade and students with disabilities (National Research Council Committee, 2009). This is partially due to their difficulty in seeing the unit, which is a challenge when it appears in a continuous line. A number line is also a shift

## Georgia Department of Education

from counting a number of individual objects in a collection to continuous length units. There are, however, ways to introduce and model number lines that support young learners as they learn this representation. Familiarity with a number line is essential because third grade students will use number lines to locate fractions and add and subtract time intervals, fourth graders will locate decimals and use them for measurement, and fifth graders will use perpendicular number lines in coordinate grids (CCSSO,2010).

A number line measures distance from zero the same way a ruler does. If you don't actually teach the use of the number line through emphasis on the unit (length), students may focus on the hash marks or numerals instead of the spaces (a misunderstanding that becomes apparent when their answers are consistently off by one). At first students can build a number path by using a given length, such as a set of Cuisenaire rods of the same color to make a straight line of multiple single units (Van de Walle and Lovin, Teaching Student-Centered Mathematics: 3-5 pg. 106-107)

Open number lines are particularly useful for building students' number sense. They can also form the basis for discussions that require the precise use of vocabulary and quantities, and are therefore a good way to engage students in the Standards for Mathematical Practice.

While the possibilities for integrating number lines into the mathematics classroom are endless, the following are some suggestions/ideas:

- On a bulletin board, attach a string which will function as an open number line. Each morning (or dedicated time for math routines) put a new number on each student's desk. Using the some type of adhesive (thumb tack, tape, etc.), students will place the number in the appropriate location on the string. In the beginning of the year, provide students with numbers that are more familiar to them. As the year progresses, move through more complex problems such as skip counting, fractions, decimals or other appropriate grade level problems. Through daily integration, the number line becomes part of the routine. Following the number placement, have a brief discussion/debriefing of the reasoning used by students to place the numbers.
- In the 3-Act tasks placed throughout the units, students will be provided opportunities to use an open number line to place estimates that are too low, too high and just right as related to the posed problem. Similar opportunities can also be used as part of a daily routine.

### **Math Maintenance Activities**

In addition to instruction centered on the current unit of study, the math instructional block should include time devoted to reviewing mathematics that have already been taught, previewing upcoming mathematics, and developing mental math and estimation skills. There is a saying that if you don't use it, you'll lose it. If students don't have opportunities to continuously apply and refine the math skills they've learned previously, then they may forget how to apply what they've learned. Unlike vocabulary words for literacy, math vocabulary words are not used much outside math class, so it becomes more important to use those words in discussions regularly. Math maintenance activities incorporate review and preview of math concepts and

## Georgia Department of Education

vocabulary and help students make connections across domains. It's recommended that 15 to 30 minutes of the math instructional block be used for these math maintenance activities each day. It's not necessary nor is it recommended that teachers do every activity every day. Teachers should strive for a balance of math maintenance activities so that over the course of a week, students are exposed to a variety of these activities. Math maintenance time may occur before or after instruction related to the current math unit, or it can occur at a different time during the day.

The goals of this maintenance time should include:

- Deepening number sense, including subitizing, flexible grouping of quantities, counting forward and backward using whole numbers, fractions, decimals and skip counting starting at random numbers or fractional amounts
- Developing mental math skills by practicing flexible and efficient numerical thinking through the use of operations and the properties of operations
- Practicing estimation skills with quantities and measurements such as length, mass, and liquid volume, depending on grade level
- Practicing previously-taught skills so that students deepen and refine their understanding
- Reviewing previously-taught concepts that students struggled with as indicated on their assessments, including gaps in math concepts taught in previous grade levels
- Using a variety of math vocabulary terms, especially those that are used infrequently
- Practicing basic facts using strategies learned in previous grade levels or in previous units to develop or maintain fluency
- Previewing prerequisite skills for upcoming math units of study
- Participating in mathematical discussions with others that require students to construct viable arguments and critique the reasoning of others

To accomplish these goals, math maintenance activities can take many different forms. Some activities include:

- Number Corner or Calendar Time
- Number Talks
- Estimation Activities/Estimation 180
- Problem of the Day or Spiraled Review Problems

In addition, math discussions, math journals and math games are appropriate not only for the current unit of study, but also for maintaining math skills that were previously taught.

Although there are commercially-available materials to use for math maintenance activities, there are also many excellent websites and internet resources that are free for classroom use. Here is a partial list of some recommended resources. A more detailed explanation of some of these components follows below.

## Georgia Department of Education

<u>Math Maintenance Activity</u>	<u>Possible Resources</u>
<b>Number Corner or Calendar Time</b>	<ul style="list-style-type: none"> <li>● <a href="http://teachelemmath.weebly.com/calendar.html">http://teachelemmath.weebly.com/calendar.html</a></li> <li>● Every Day Counts Calendar Math from Houghton Mifflin Harcourt</li> <li>● Number Corner from The Math Learning Center</li> </ul>
<b>Number Talks</b>	<ul style="list-style-type: none"> <li>● <i>Number Talks</i> by Sherry Parrish</li> <li>● <a href="http://kentuckymathematics.org/number_talk_resources.php">http://kentuckymathematics.org/number_talk_resources.php</a></li> </ul>
<b>Estimation Activities/Estimation 180</b>	<ul style="list-style-type: none"> <li>● <a href="http://www.estimated180.com/">http://www.estimated180.com/</a></li> </ul>
<b>Problem of the Day/Spiraled Review Problems</b>	<ul style="list-style-type: none"> <li>● <a href="http://www.insidemathematics.org">www.insidemathematics.org</a></li> <li>● <a href="http://nzmaths.co.nz/teaching-material">http://nzmaths.co.nz/teaching-material</a></li> <li>● <a href="http://www.k-5mathteachingresources.com/">http://www.k-5mathteachingresources.com/</a></li> <li>● <a href="http://mathlearnnc.sharpschool.com/cms/One.aspx?portalId=4507283&amp;pageId=5856325">http://mathlearnnc.sharpschool.com/cms/One.aspx?portalId=4507283&amp;pageId=5856325</a></li> <li>● <i>Children’s Mathematics: Cognitively Guided Instruction</i> by Thomas Carpenter, et. Al.</li> <li>● <i>Extending Children’s Mathematics: Fractions and Decimals</i> by Epsen and Levi</li> </ul>

### **Number Corner/Calendar Time**

Number Corner/Calendar Time is an interactive routine centered on a monthly calendar in which students can use the date or day of the school year as a starting point for math discussions. Typically, there are date cards for each day of the month with repeating or growing patterns. The patterns can be numeric or geometric and can lead to rich discussions of math vocabulary and predictions of what the next date card will look like. The day of the school year can be used as a basis for discussions of patterns on the 100’s chart, or the days can each be multiplied by 0.01 so that a decimal 100’s chart is developed. Fractions can be created using today’s date as a numerator, with a set denominator to use as a basis for discussions of equivalent fractions, improper fractions, and mixed numbers. Measurement can be discussed, using today’s date as the basis for money, coins, number of inches, ounces, minutes, angles, etc. There are many possibilities for mathematizing every math domain by using the calendar as a generator of changing daily number (date or day of school year).

A monthly calendar board or corner can be set up with chart paper or dry erase paper to record predictions, vocabulary, and other elements. A Smartboard could also be used to organize calendar elements. If calendar elements are hung on the wall, then students will be able to refer to those visual displays as reminders and reinforcement at any time. The following elements

## Georgia Department of Education

should be in place in order to foster deep discussions and meaningful student engagement during calendar time:

- A safe environment
- Math models and tools, such as a hundreds chart, number line, measurement tools, play money
- Opportunities to think first and then discuss
- Student interaction and discourse

### Number Talks

In order to be mathematically proficient, students must be able to compute accurately, efficiently, and flexibly. Daily classroom number talks provide a powerful avenue for developing “efficient, flexible, and accurate computation strategies that build upon the key foundational ideas of mathematics.” (Parrish, 2010) Number talks involve classroom conversations and discussions centered upon purposefully planned computation problems.

In Sherry Parrish’s book, Number Talks: Helping Children Build Mental Math and Computation Strategies, teachers will find a wealth of information about Number Talks, including:

- Key components of Number Talks
- Establishing procedures
- Setting expectations
- Designing purposeful Number Talks
- Developing specific strategies through Number Talks

There are four overarching goals upon which K-2 teachers should focus during Number Talks. These goals are:

1. Developing number sense
2. Developing fluency with small numbers
3. Subitizing
4. Making Tens

Number talks are a great way for students to use mental math to solve and explain a variety of math problems. A Number Talk is a short, ongoing daily routine that provides students with meaningful ongoing practice with computation. Number Talks should be structured as short sessions alongside (but not necessarily directly related to) the ongoing math curriculum. A great place to introduce a Number Talk is during Number Corner/Calendar Time. It is important to keep Number Talks short, as they **are not intended to replace current curriculum or take up the majority of the time spent on mathematics**. In fact, teachers only need to spend 5 to 15 minutes on Number Talks. Number Talks are most effective when done every day. The primary goal of Number Talks is computational fluency. Children develop computational fluency while thinking and reasoning like mathematicians. When they share their strategies with others, they learn to clarify and express their thinking, thereby developing mathematical language. This in turn serves them well when they are asked to express their mathematical processes in writing. In order for children to become computationally fluent, they need to know particular mathematical concepts that go beyond what is required to memorize basic facts or procedures.

Students will begin to understand major characteristics of numbers, such as:

- Numbers are composed of smaller numbers.

## Georgia Department of Education

- Numbers can be taken apart and combined with other numbers to make new numbers.
- What we know about one number can help us figure out other numbers.
- What we know about parts of smaller numbers can help us with parts of larger numbers.
- Numbers are organized into groups of tens and ones (and hundreds, tens and ones and so forth).
- What we know about numbers to 10 helps us with numbers to 100 and beyond.

All Number Talks follow a basic six-step format. The format is always the same, but the problems and models used will differ for each number talk.

1. **Teacher presents the problem.** Problems are presented in many different ways: as dot cards, ten frames, sticks of cubes, models shown on the overhead, a word problem or a written algorithm. Strategies are *not explicitly taught* to students, instead the problems presented lead to various strategies.
2. **Students figure out the answer.** Students are given time to figure out the answer. To make sure students have the time they need, the teacher asks them to give a “thumbs-up” when they have determined their answer. The thumbs up signal is unobtrusive- a message to the teacher, not the other students.
3. **Students share their answers.** Four or five students volunteer to share their answers and the teacher records them on the board.
4. **Students share their thinking.** Three or four students volunteer to share how they got their answers. (Occasionally, students are asked to share with the person(s) sitting next to them.) The teacher records the student's thinking.
5. **The class agrees on the "real" answer for the problem.** The answer that together the class determines is the right answer is presented as one would the results of an experiment. The answer a student comes up with initially is considered a conjecture. Models and/or the logic of the explanation may help a student see where their thinking went wrong, may help them identify a step they left out, or clarify a point of confusion. There should be a sense of confirmation or clarity rather than a feeling that each problem is a test to see who is right and who is wrong. A student who is still unconvinced of an answer should be encouraged to keep thinking and to keep trying to understand. For some students, it may take one more experience for them to understand what is happening with the numbers and for others it may be out of reach for some time. The mantra should be, "If you are not sure or it doesn't make sense yet, keep thinking."
6. **The steps are repeated for additional problems.**

Similar to other procedures in your classroom, there are several elements that must be in place to ensure students get the most from their Number Talk experiences. These elements are:

1. A safe environment
2. Problems of various levels of difficulty that can be solved in a variety of ways
3. Concrete models
4. Opportunities to think first and then check
5. Interaction
6. Self-correction

For further information about implementing Number Talks, see the Effective Instructional Practices Guide: <https://extranet.georgiastandards.org/Georgia-Standards/Documents/GSE-Effective-Instructional-Practices-Guide.pdf>

## Georgia Department of Education

Click here to watch an outstanding model number talk on division:

[\\*https://www.teachingchannel.org/videos/common-core-teaching-division](https://www.teachingchannel.org/videos/common-core-teaching-division)

### **Estimation 180**

Estimation is a skill that has many applications, such as checking computation answers quickly. Engaging in regular estimation activities will develop students' reasoning skills, number sense, and increase their repertoire of flexible and efficient strategies. As students gain more experiences with estimation, their accuracy will improve.

According to John Van de Walle, there are three types of estimation that students should practice:

- Measurement estimation – determining an approximate measurement, such as weight, length, or capacity
- Quantity estimation – approximating the number of items in a collection
- Computational estimation – determining a number that is an approximation of a computation

One resource which provides contexts for all three types of estimation is Andrew Stadel's website, <http://www.estimate180.com/>. In his website, Mr. Stadel has posted daily estimation contexts. Here are his directions for using his website:

1. Click on a picture.
2. Read the question.
3. Look for context clues.
4. Make an estimate.
5. Tell us how confident you are.
6. Share your reasoning (what context clues did you use?).
7. See the answer.
8. See the estimates of others.

**The most important part** is step #6. After you make an estimate, feel free to give a brief description. It's so valuable to a classroom when students share their logic or use of context clues when formulating an estimate.

Andrew Stadel has collaborated with Michael Fenton to create a recording sheet for students to use with the estimation contexts on the website. The recording sheet can also be found at <http://www.estimate180.com/>. Here are his directions for the recording sheet:



## Georgia Department of Education

Day #	Description	↓ Too Low	Too High ↑	My Estimate	My Reasoning	Answer	Error	Error  as %
Ex. A	Tyler's age (months)	24	36	30	He looks a little older than my cousin (who is 2)	26	⊕ - 4	4/26 ≈ 15%
Ex. B	<i>Bohemian Rhapsody</i>	4:00	5:00	4:30	10% of song = 30 sec 300 sec total = 5 min	5:56	+ ⊖ 86	86/356 ≈ 24%
							+ -	

**Column use descriptions from Andrew Stadel:**

### Day #

In Estimation 180's first year, I was just trying to keep up with creating these estimation challenges in time for use in my own classroom. There really wasn't a scope and sequence involved. That said, now that there are over 160 estimation challenges available, teachers and students can use them at any time throughout the school year and without completing them in sequential order. Therefore, use the *Day #* column simply to number your daily challenges according to the site. Tell your students or write it up on the board that you're doing the challenge from [Day 135](#) even though you might be on the fifth day of school.

### Description

In my opinion, this column is more important than the *Day #* column. Don't go crazy here. Keep it short and sweet, but as specific as possible. For example, there's a lot of scattered height estimates on the site. Don't write down "How tall?" for [Day 110](#). Instead write "Bus height" because when you get to [Day 111](#), I'd write in "Parking structure height". I believe the teacher has the ultimate say here, but it can be fun to poll your students for a short description in which you all can agree. Give students some ownership, right? If unit measurement is involved, try and sneak it in here. Take Day 125 for instance. I'd suggest entering "Net Wt. (oz.) of lg Hershey's bar." Keep in mind that Day 126 asks the same question, but I'd suggest you encourage your class to use pounds if they don't think of it.

\*By the way, sometimes unit measurement(s) are already included in the question. Use discretion.

### Too Low

Think of an estimate that is too low.

Don't accept one (1), that's just rubbish, unless one (1) is actually applicable to the context of the challenge. Stretch your students. Think of it more as an answer that's too low, but reasonably close. After all, this is a site of estimation challenges, not gimmes.

### Too High

Refer to my notes in *Too Low*. Just don't accept 1 billion unless it's actually applicable. Discuss with students the importance of the *Too Low* and *Too High* sections: we are trying to eliminate wrong answers while creating a range of possible answers.

### My Estimate

This is the place for students to fill in their answer. If the answer requires a unit of measurement, we better see one. Not every estimation challenge is "How many..." marshmallows? or christmas lights? or cheese balls?

## Georgia Department of Education

Even if a unit of measurement has already been established (see the *Description* notes), I'd still encourage your students to accompany their numerical estimate with a unit of measurement.



For example, on Day 41, "What's the height of the Giant [Ferris] Wheel?" use what makes sense to you, your students and your country's customary unit of measurement. Discuss the importance of unit measurements with students. Don't accept 108. What does that 108 represent? Pancakes? Oil spills? Bird droppings? NO! It represents 108 feet.

### My Reasoning

The *My Reasoning* section is the most recent addition to the handout and I'm extremely thrilled about it. This is a student's chance to shine! Encourage their reasoning to be short and sweet. When a student writes something down, they'll be more inclined to share it or remember it. Accept bullet points or phrases due to the limited space. We don't need students to write paragraphs. However, we are looking for students to identify any context clues they used, personal experiences, and/or prior knowledge. Hold students accountable for their reasoning behind the estimate of the day.

**Don't let student reasoning go untapped!** If you're doing a sequence of themed estimation challenges, don't accept, "I just guessed" after the first day in the sequence. For example, if you're doing the flight distance themed estimate challenges starting on Day 136, you will establish the distance across the USA on the first day. Sure, go ahead and guess on Day 136, but make sure you hold students accountable for their reasoning every day thereafter. Have students share their reasoning before and after revealing the answer. Utilize Think-Pair-Share. This will help create some fun conversations *before* revealing the answer. After revealing the answer, get those who were extremely close (or correct) to share their reasoning. I bet you'll have some great mathematical discussions. I'm also curious to hear from those that are way off and how their reasoning could possibly be improved.

I'd say the *My Reasoning* section was born for Mathematical Practice 3: *Construct viable arguments and critique the reasoning of others*. Keep some of these thoughts in mind regarding Mathematical Practice 3:

- Explain and defend your estimate.
- Construct a detailed explanation referencing context clues, prior knowledge, or previous experiences.
- Invest some confidence in it.
- Try to initiate a playful and respectful argument in class.
- Ask "Was anyone convinced by this explanation? Why? Why not?" or "Are you guys going to let [student name] off the hook with that explanation?"

There's reasoning behind every estimate (not guess).

- Find out what that reasoning is!
- DON'T let student reasoning go untapped!

## Georgia Department of Education

### **Answer**

Jot down the revealed answer. I'd also encourage students to write down the unit of measurement used in the answer. The answer might use a different unit of measurement than what you and your class agreed upon. Take the necessary time to discuss the most relative unit of measurement. I might be subjectively wrong on some of the answers posted. As for more thoughts on unit of measurement, refer to the *My Estimate* notes above. Continue having mathematical discussion after revealing the answer. Refer to my notes regarding the use of Mathematical Practice 3 in the *My Reasoning* section.

### **Error**

Find the difference between *My Estimate* and *Answer*. Have students circle either the "+" or the "-" if they didn't get it exactly correct.

+ Your estimate was **greater** than (above) the actual answer.

- Your estimate was **less** than (below) the actual answer.

### **Mathematize the World through Daily Routines**

The importance of continuing the established classroom routines cannot be overstated. Daily routines must include such obvious activities such as taking attendance, doing a lunch count, determining how many items are needed for snack, lining up in a variety of ways (by height, age, type of shoe, hair color, eye color, etc.), and daily questions. They should also include less obvious routines, such as how to select materials, how to use materials in a productive manner, how to put materials away, and have productive discourse about the mathematics in which students are engaged. An additional routine is to allow plenty of time for children to explore new materials before attempting any directed activity with these new materials. The regular use of the routines are important to the development of students' number sense, flexibility, and fluency, which will support students' performances on the tasks in this unit.

### **Workstations and Learning Centers**

When thinking about developing work stations and learning centers you want to base them on student readiness, interest, or learning profile such as learning style or multiple intelligence. This will allow different students to work on different tasks. Students should be able to complete the tasks within the stations or centers independently, with a partner or in a group.

It is important for students to be engaged in purposeful activities within the stations and centers. Therefore, you must carefully consider the activities selected to be a part of the stations and centers. When selecting an activity, you may want to consider the following questions:

- Will the activity reinforce or extend a concept that's already been introduced?
- Are the directions clear and easy to follow?
- Are materials easy to locate and accessible?
- Can students complete this activity independently or with minimal help from the teacher?
- How will students keep a record of what they've completed?
- How will students be held accountable for their work?

(Laura Candler, *Teaching Resources*)

When implementing work stations and learning centers within your classroom, it is important to consider when the stations and centers will be used. Will you assign students to specific stations or centers to complete each week or will they be able to select a station or center of their choice?

## Georgia Department of Education

Will this opportunity be presented to all students during particular times of your math block or to students who finish their work early?

Just as with any task, some form of recording or writing should be included with stations whenever possible. Students solving a problem on a computer can write up what they did and explain what they learned.

### **Games**

“A game or other repeatable activity may not look like a problem, but it can nonetheless be problem based. The determining factor is this: Does the activity cause students to be reflective about new or developing relationships? If the activity merely has students repeating procedure without wrestling with an emerging idea, then it is not a problem-based experience.

Students playing a game can keep records and then tell about how they played the game- what thinking or strategies they used.” (Van de Walle and Lovin, Teaching Student-Centered Mathematics: 3-5 pg. 28

### **Journaling**

"Students should be writing and talking about math topics every day. Putting thoughts into words helps to clarify and solidify thinking. By sharing their mathematical understandings in written and oral form with their classmates, teachers, and parents, students develop confidence in themselves as mathematical learners; this practice also enables teachers to better monitor student progress." NJ DOE

"Language, whether used to express ideas or to receive them, is a very powerful tool and should be used to foster the learning of mathematics. Communicating about mathematical ideas is a way for students to articulate, clarify, organize, and consolidate their thinking. Students, like adults, exchange thoughts and ideas in many ways—orally; with gestures; and with pictures, objects, and symbols. By listening carefully to others, students can become aware of alternative perspectives and strategies. By writing and talking with others, they learn to use more-precise mathematical language and, gradually, conventional symbols to express their mathematical ideas. Communication makes mathematical thinking observable and therefore facilitates further development of that thought. It encourages students to reflect on their own knowledge and their own ways of solving problems. Throughout the early years, students should have daily opportunities to talk and write about mathematics." NCTM

When beginning math journals, the teacher should model the process initially, showing students how to find the front of the journal, the top and bottom of the composition book, how to open to the next page in sequence (special bookmarks or ribbons), and how to date the page. Discuss the usefulness of the book, and the way in which it will help students retrieve their math thinking whenever they need it.

When beginning a task, you can ask, "What do we need to find out?" and then, "How do we figure it out?" Then figure it out, usually by drawing representations, and eventually adding words, numbers, and symbols. During the closing of a task, have students show their journals with a document camera or overhead when they share their thinking. This is an excellent opportunity to discuss different ways to organize thinking and clarity of explanations.

## Georgia Department of Education

Use a composition notebook (the ones with graph paper are terrific for math) for recording or drawing answers to problems. The journal entries can be from Frameworks tasks, but should also include all mathematical thinking. Journal entries should be simple to begin with and become more detailed as the children's problem-solving skills improve. Children should always be allowed to discuss their representations with classmates if they desire feedback. The children's journal entries demonstrate their thinking processes. Each entry could first be shared with a "buddy" to encourage discussion and explanation; then one or two children could share their entries with the entire class. Don't forget to praise children for their thinking skills and their journal entries! These journals are perfect for assessment and for parent conferencing. The student's thinking is made visible!

### **GENERAL QUESTIONS FOR TEACHER USE**

Adapted from *Growing Success* and materials from Math GAINS and *TIPS4RM*

#### **Reasoning and Proving**

- How can we show that this is true for all cases?
- In what cases might our conclusion not hold true?
- How can we verify this answer?
- Explain the reasoning behind your prediction.
- Why does this work?
- What do you think will happen if this pattern continues?
- Show how you know that this statement is true.
- Give an example of when this statement is false.
- Explain why you do not accept the argument as proof.
- How could we check that solution?
- What other situations need to be considered?

#### **Reflecting**

- Have you thought about...?
- What do you notice about...?
- What patterns do you see?
- Does this problem/answer make sense to you?
- How does this compare to...?
- What could you start with to help you explore the possibilities?
- How can you verify this answer?
- What evidence of your thinking can you share?
- Is this a reasonable answer, given that...?

#### **Selecting Tools and Computational Strategies**

- How did the learning tool you chose contribute to your understanding/solving of the problem? Assist in your communication?
- In what ways would [name a tool] assist in your investigation/solving of this problem?
- What other tools did you consider using? Explain why you chose not to use them.
- Think of a different way to do the calculation that may be more efficient.

## Georgia Department of Education

- What estimation strategy did you use?

### Connections

- What other math have you studied that has some of the same principles, properties, or procedures as this?
- How do these different representations connect to one another?
- When could this mathematical concept or procedure be used in daily life?
- What connection do you see between a problem you did previously and today's problem?

### Representing

- What would other representations of this problem demonstrate?
- Explain why you chose this representation.
- How could you represent this idea algebraically? Graphically?
- Does this graphical representation of the data bias the viewer? Explain.
- What properties would you have to use to construct a dynamic representation of this situation?
- In what way would a scale model help you solve this problem?

### QUESTIONS FOR TEACHER REFLECTION

- How did I assess for student understanding?
- How did my students engage in the 8 mathematical practices today?
- How effective was I in creating an environment where meaningful learning could take place?
- How effective was my questioning today? Did I question too little or say too much?
- Were manipulatives made accessible for students to work through the task?
- Name at least one positive thing about today's lesson and one thing you will change.
- How will today's learning impact tomorrow's instruction?

**MATHEMATICS DEPTH-OF-KNOWLEDGE LEVELS**

**Level 1 (Recall)** includes the recall of information such as a fact, definition, term, or a simple procedure, as well as performing a simple algorithm or applying a formula. That is, in mathematics a one-step, well-defined, and straight algorithmic procedure should be included at this lowest level. Other key words that signify a Level 1 include “identify,” “recall,” “recognize,” “use,” and “measure.” Verbs such as “describe” and “explain” could be classified at different levels depending on what is to be described and explained.

**Level 2 (Skill/Concept)** includes the engagement of some mental processing beyond a habitual response. A Level 2 assessment item requires students to make some decisions as to how to approach the problem or activity, whereas Level 1 requires students to demonstrate a rote response, perform a well-known algorithm, follow a set procedure (like a recipe), or perform a clearly defined series of steps. Keywords that generally distinguish a Level 2 item include “classify,” “organize,” “estimate,” “make observations,” “collect and display data,” and “compare data.” These actions imply more than one step. For example, to compare data requires first identifying characteristics of the objects or phenomenon and then grouping or ordering the objects. Some action verbs, such as “explain,” “describe,” or “interpret” could be classified at different levels depending on the object of the action. For example, if an item required students to explain how light affects mass by indicating there is a relationship between light and heat, this is considered a Level 2. Interpreting information from a simple graph, requiring reading information from the graph, also is a Level 2. Interpreting information from a complex graph that requires some decisions on what features of the graph need to be considered and how information from the graph can be aggregated is a Level 3. Caution is warranted in interpreting Level 2 as only skills because some reviewers will interpret skills very narrowly, as primarily numerical skills, and such interpretation excludes from this level other skills such as visualization skills and probability skills, which may be more complex simply because they are less common. Other Level 2 activities include explaining the purpose and use of experimental procedures; carrying out experimental procedures; making observations and collecting data; classifying, organizing, and comparing data; and organizing and displaying data in tables, graphs, and charts.

**Level 3 (Strategic Thinking)** requires reasoning, planning, using evidence, and a higher level of thinking than the previous two levels. In most instances, requiring students to explain their thinking is a Level 3. Activities that require students to make conjectures are also at this level. The cognitive demands at Level 3 are complex and abstract. The complexity does not result from the fact that there are multiple answers, a possibility for both Levels 1 and 2, but because the task requires more demanding reasoning. An activity, however, that has more than one possible answer and requires students to justify the response they give would most likely be a Level 3. Other Level 3 activities include drawing conclusions from observations; citing evidence and developing a logical argument for concepts; explaining phenomena in terms of concepts; and using concepts to solve problems.

## Georgia Department of Education

### *DOK cont'd...*

**Level 4 (Extended Thinking)** requires complex reasoning, planning, developing, and thinking most likely over an extended period of time. The extended time period is not a distinguishing factor if the required work is only repetitive and does not require applying significant conceptual understanding and higher-order thinking. For example, if a student has to take the water temperature from a river each day for a month and then construct a graph, this would be classified as a Level 2. However, if the student is to conduct a river study that requires taking into consideration a number of variables, this would be a Level 4. At Level 4, the cognitive demands of the task should be high and the work should be very complex. Students should be required to make several connections—relate ideas *within* the content area or *among* content areas—and have to select one approach among many alternatives on how the situation should be solved, in order to be at this highest level. Level 4 activities include designing and conducting experiments; making connections between a finding and related concepts and phenomena; combining and synthesizing ideas into new concepts; and critiquing experimental designs.

### **DEPTH AND RIGOR STATEMENT**

By changing the way we teach, we are not asking children to learn less, we are asking them to learn more. We are asking them to mathematize, to think like mathematicians, to look at numbers before they calculate, to think rather than to perform rote procedures. Children can and do construct their own strategies, and when they are allowed to make sense of calculations in their own ways, they understand better. In the words of Blaise Pascal, “We are usually convinced more easily by reasons we have found ourselves than by those which have occurred to others.”

By changing the way we teach, we are asking teachers to think mathematically, too. We are asking them to develop their own mental math strategies in order to develop them in their students.

Catherine Twomey Fosnot and Maarten Dolk, *Young Mathematicians at Work*.

While you may be tempted to explain and show students how to do a task, much of the learning comes as a result of making sense of the task at hand. Allow for the productive struggle, the grappling with the unfamiliar, the contentious discourse, for on the other side of frustration lies understanding and the confidence that comes from “doing it myself!”



**Georgia Department of Education**

**Problem Solving Rubric (3-5)**

<b>SMP</b>	<b>1-Emergent</b>	<b>2-Progressing</b>	<b>3- Meets/Proficient</b>	<b>4-Exceeds</b>
Make sense of problems and persevere in solving them.	The student was unable to explain the problem and showed minimal perseverance when identifying the purpose of the problem.	The student explained the problem and showed some perseverance in identifying the purpose of the problem, and selected and applied an appropriate problem solving strategy that lead to a partially complete and/or partially accurate solution.	The student explained the problem and showed perseverance when identifying the purpose of the problem, and selected an applied and appropriate problem solving strategy that lead to a generally complete and accurate solution.	The student explained the problem and showed perseverance by identifying the purpose of the problem and selected and applied an appropriate problem solving strategy that lead to a thorough and accurate solution. In addition, student will check answer using another method.
Attends to precision	The student was unclear in their thinking and was unable to communicate mathematically.	The student was precise by clearly describing their actions and strategies, while showing understanding and using appropriate vocabulary in their process of finding solutions.	The student was precise by clearly describing their actions and strategies, while showing understanding and using grade-level appropriate vocabulary in their process of finding solutions.	
Reasoning and explaining	The student was unable to express or justify their opinion quantitatively or abstractly using numbers, pictures, charts or words.	The student expressed or justified their opinion either quantitatively OR abstractly using numbers, pictures, charts OR words.	The student expressed and justified their opinion both quantitatively and abstractly using numbers, pictures, charts and/or words. Student is able to make connections between models and equations.	The student expressed and justified their opinion both quantitatively and abstractly using a variety of numbers, pictures, charts and words. The student connects quantities to written symbols and create a logical representation with precision.
Models and use of tools	The student was unable to select an appropriate tool, draw a representation to reason or justify their thinking.	The student selected an appropriate tools or drew a correct representation of the tools used to reason and justify their response.	The student selected an efficient tool and/or drew a correct representation of the efficient tool used to reason and justify their response.	The student selected multiple efficient tools and correctly represented the tools to reason and justify their response. In addition this students was able to explain why their tool/ model was efficient
Seeing structure and generalizing	The student was unable to identify patterns, structures or connect to other areas of mathematics and/or real-life.	The student identified a pattern or structure in the number system and noticed connections to other areas of mathematics or real-life.	The student identified patterns or structures in the number system and noticed connections to other areas of mathematics and real-life.	The student identified various patterns and structures in the number system and noticed connections to multiple areas of mathematics and real-life.

Created by Richmond County School District

## Georgia Department of Education

### SUGGESTED LITERATURE

*Millions of Cats.* (2006/1928) by Wanda Ga'g  
*How Much is a Million?* (1997) by David M. Schwartz  
*If You Made a Million.* (1994) by David M. Schwartz  
*On Beyond a Million: An Amazing Math Journey.* (2001) by David M. Schwartz  
*Count to a Million: 1,000,000.* (2003) by Jerry Pallotta  
*The Fly on the Ceiling* by Dr. Julie Glass

### TECHNOLOGY LINKS

- [\\*http://www.openmiddle.com/category/grade-5/](http://www.openmiddle.com/category/grade-5/) This website contains rich, thought-provoking tasks aligned to standards.
- [\\*http://robertkaplinsky.com/lessons/](http://robertkaplinsky.com/lessons/) Contextualized, real-world, problem-based lessons from Robert Kaplinsky.
- [\\*http://www.visualfractions.com/](http://www.visualfractions.com/) A must-use website to help develop conceptual understanding of fraction skills and concepts.
- [\\*http://www.decimalsquares.com/dsGames/](http://www.decimalsquares.com/dsGames/) Decimal-focused games.
- [\\*http://www.dreambox.com/teachertools](http://www.dreambox.com/teachertools) Free, highly dynamic, interactive tools for developing number sense.
- [\\*http://www.dreambox.com/k-8-math-lessons](http://www.dreambox.com/k-8-math-lessons) More tools from Dreambox.
- [\\*https://www.conceptuamath.com/app/tool-library](https://www.conceptuamath.com/app/tool-library) Free, highly dynamic, interactive tools for modeling math concepts and developing number sense.
- [\\*http://gregtangmath.com/](http://gregtangmath.com/) Great source of engaging, challenging math activities, including number puzzles, standards-based games, and rich fluency practice.
- <http://www.aaamath.com/plc51b-placevalues.html> This website contains some information and activities dealing with place value and decimals.
- <http://mathforum.org/library/> This website for The Math Forum Internet Mathematics Library provides a variety of mathematical content information as well as other useful math website links.
- <http://www.internet4classrooms.com/> This website contains helpful classroom ideas for teachers to use with their classroom instruction.
- <http://illuminations.nctm.org/ActivityDetail.aspx?ID=6>: Determining the Volume of a Box by Filling It with Cubes, Rows of Cubes, or Layers of Cubes
- <http://www.kongregate.com/games/smartcode/liquid-measure>
- <http://teacher.scholastic.com/maven/triplets/index.htm>
- <http://www1.center.k12.mo.us/edtech/resources/money.htm>
- <http://teacher.scholastic.com/maven/daryl/index.htm>
- <http://www.ambleside.cumbria.sch.uk/>
- <http://mathopenref.com>
- IXL Common Core: <http://www.ixl.com/math/standards/common-core/grade-5>
- K-5 Teaching Mathematics: <http://www.k-5mathteachingresources.com>
- Rocking the Standards Math (CD): <http://www.rockinthestandards.com/site/>

### Additional Resources:

[http://kentuckymathematics.org/pimser\\_printables.php](http://kentuckymathematics.org/pimser_printables.php)

Richard Woods, State School Superintendent

July 2016 • Page 74 of 75

All Rights Reserved

## Georgia Department of Education

### **RESOURCES CONSULTED**

#### **Content:**

Mathematics Progressions Documents

<http://ime.math.arizona.edu/progressions/>

Illustrative Mathematics

<https://www.illustrativemathematics.org/>

Ohio DOE

<http://www.ode.state.oh.us/GD/Templates/Pages/ODE/ODEPrimary.aspx?page=2&TopicRelationID=1704>

Arizona DOE

<http://www.azed.gov/standards-practices/mathematics-standards/>

Nzmaths

<http://nzmaths.co.nz/>

#### **Teacher/Student Sense-making:**

<http://www.youtube.com/user/mitcccnyorg?feature=watch>

<https://www.georgiastandards.org/Common-Core/Pages/Math.aspx>

[http://secc.sedl.org/common\\_core\\_videos/](http://secc.sedl.org/common_core_videos/)

#### **Journaling:**

<http://www.mathsolutions.com/index.cfm?page=wp10&crd=3>

#### **Community of Learners:**

\*<https://www.teachingchannel.org/videos/class-warm-up-routine> (Great example of community-of-learners based approach to embracing mistakes)

<http://www.edutopia.org/math-social-activity-cooperative-learning-video>

<http://www.edutopia.org/math-social-activity-sel>

<http://www.youtube.com/user/responsiveclassroom/videos>