

Evanston Township High School

Report on Student Achievement & Restructured Freshman Year

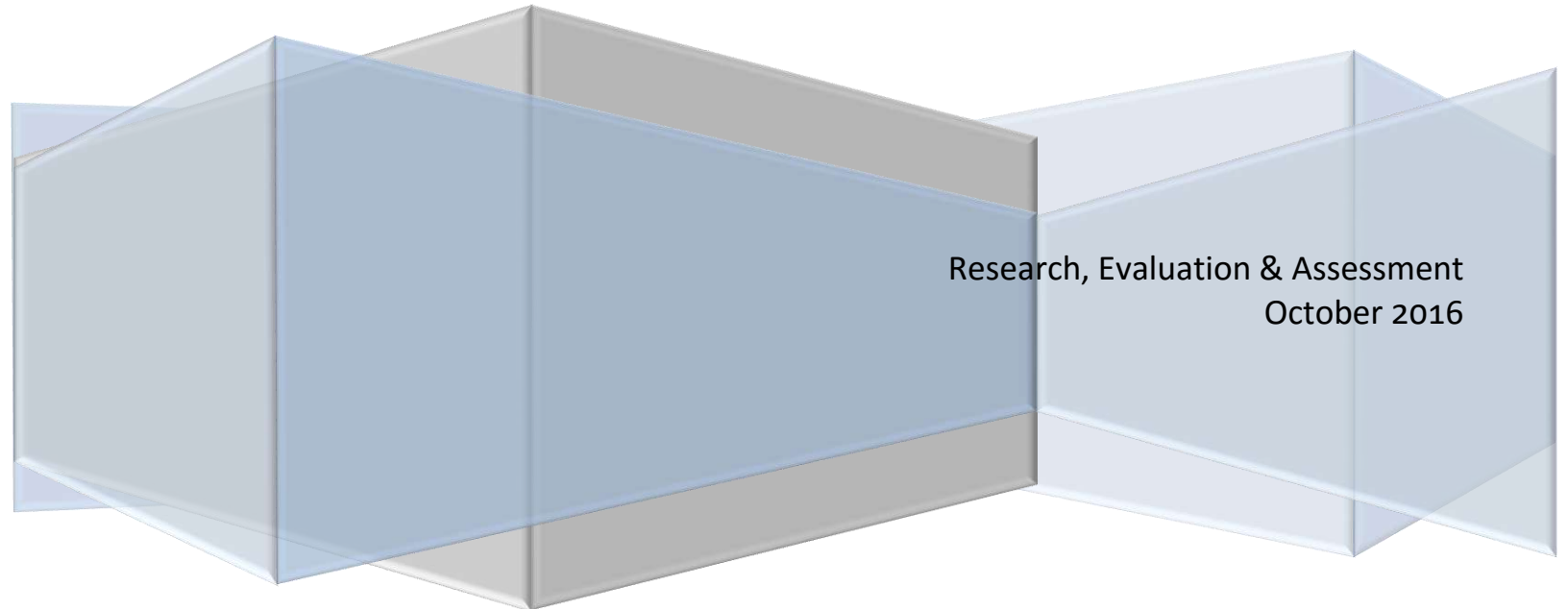

Research, Evaluation & Assessment
October 2016

Contents

Student Achievement Report

EXECUTIVE SUMMARY	1
Purpose of Report.....	2
Definitions.....	3
Goal 1: Increase each student’s academic trajectory as demonstrated through multiple measures.....	5
100% of students will meet expected growth from EXPLORE to ACT	5
84% of grade 11 and 12 students will be enrolled honors and AP courses	6
Percent of graduating seniors enrolled in at least one AP course	7
71% of graduating seniors will earn a score of 3 or higher on at least one AP exam.....	8
80% of students will continue in a post-secondary institution within two semesters of graduating high school	9
100% of freshmen on track to graduate	10
100% of students will meet or exceed ACT College Readiness Benchmarks in English	11
100% of students will meet or exceed ACT College Readiness Benchmarks in mathematics.....	12
Goal 2: Provide individualized supports, programs, services and curricula to ensure that each student will demonstrate significant academic and socio-emotional growth during their experience at ETHS .	13
100% of students will graduate (four-year)	13
100% of students will graduate (five-year).....	14

Restructured Freshman Year

EXECUTIVE SUMMARY	16
Definitions.....	18
Grade 9 Students Demonstrating Mastery – ENGLISH.....	20
Grade 9 Students Demonstrating Mastery – HISTORY	21
Grade 9 Students Demonstrating Mastery – BIOLOGY	22
Grades 10~12 Students Succeeding in Honors and/or AP Courses.....	23
Four-Year Graduation Rate.....	24
ACT – English – Meeting or Exceeding College Readiness Benchmark.....	25
ACT – Percent Meeting/Exceeding Composite Score of 24 or Greater	26
ACT – Percent Meeting/Exceeding Composite Score of 27 or Greater	27
Advanced Placement Course Enrollment-One or More Course	28
Advanced Placement Exams-Students Earning a 3 or Higher on One or More Exam	29

Report on Student Achievement

2013-14 through 2015-16

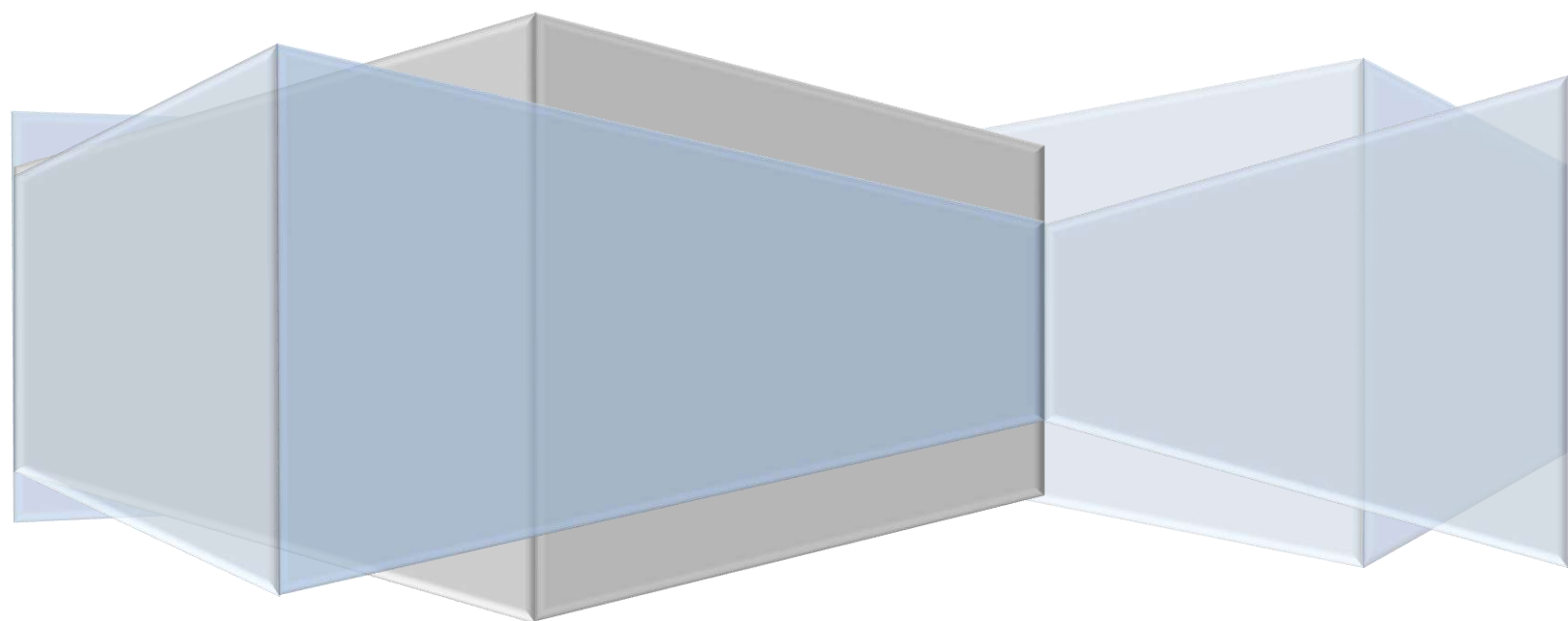

EXECUTIVE SUMMARY

The following report provides analyses of assessment results and other key academic indicators. Key highlights include:

- In 2015-16, 83% of grade 11 or 12 students were enrolled in at least one honors or AP course in the first semester, compared to 85% in 2014-15 and 82% in 2013-14.
- Seventy-three percent of the 2016 graduate cohort were enrolled in at least one AP course, compared to 79% of the 2015 graduates and 74% of the 2014 graduates.
 - Of the 2016 graduating seniors enrolled in at least one AP course, 62% earned a score of 3 or higher on at least one AP exam. This is down from 74% of the 2015 graduates and 66% of the 2014 graduates.
- In 2016, 72% of graduating seniors met the ACT College Readiness Benchmark in English with a score of 18 or higher, compared to 74% in 2015 and 71% in 2014.
- In 2016, 59% of graduating seniors met the ACT College Readiness Benchmark in math with a score of 22 or higher, compared to 61% in 2015 and 57% in 2014.
- According to National Student Clearinghouse data, about 84% of 2014 graduates continued in a post-secondary institution within two semesters of graduating from ETHS.

The 2015-16 IL Report Card is expected to be released in October, 2016. If there are any changes to the data reported here this report will be updated accordingly.

Purpose of Report

The purpose of this report is to communicate ETHS' progress toward meeting some of its goals for the 2013-14 through 2015-16 school years. Only the goals that directly reflect the academic success of students are included.

DISTRICT 202 GOALS 2012-2016

Goal #1: Increase each student's academic trajectory as demonstrated through multiple measures.

- 100% of students will meet expected growth; work toward 100% of students exceeding expected growth from EXPLORE to ACT by race, income status and IEP. Measure: EPAS System (EXPLORE to ACT)
- 71% of graduating seniors will pass (score of 3 or higher) at least one AP test prior to graduation. Measure: Advanced Placement (AP) examination scores
- 84% of grade 11 and 12 students will be enrolled in honors and AP courses by race and income. Measure: Course enrollments.
- 80% of students will continue in school within two semesters of graduating high school. Measure: National Student Clearinghouse database.
- 100% of freshmen on track to graduate by race, income status and IEP. Measure: Earned course credit in core subjects.
- 100% of students will be on track for ACT College Readiness benchmarks in English and math. Measure: ACT

Goal #2: Provide individualized supports, programs, services and curricula to ensure that each student will demonstrate significant academic and social-emotional growth during their experience at ETHS.

- 100% of students will graduate. Measure: ISBE-calculated graduation rate.

Definitions

Student Groups

Student data is analyzed by race/ethnicity, income and special education status.

- Race/ethnicity groups reflect the federal reporting categories – American Indian or Alaska Native, Asian, Black or African American, Hispanic or Latino, Native Hawaiian or Other Pacific Islander, Two or More Races and White. Race/ethnicity groups are only included if their size is greater than 10.
- Income groups reflect students' free or reduced price lunch status. Students who qualify for either free or reduced price lunch are categorized as low income. All other students are categorized as non-low income.
- Special education groups reflect students' Individualized Education Program (IEP) status. Students who have an IEP are categorized as special education and those who do not are categorized as non-special education.

Groups that have a small number of students should be interpreted with caution since their results may fluctuate widely from year to year.

ACT - General

The ACT assessment is a college admissions and placement test that focuses on the skills important for students to successfully transition from high school to college. The ACT includes tests of English, math, reading and science reasoning. Scores range from 1 through 36 and are provided for each test and a composite. Most ETHS students take the ACT at least once. The scores reflected in this report reflect ETHS's 2014, 2015 and 2016 graduates who tested under standard and extended time conditions. The highest test score is used for students who took the test more than once.

ACT – College Readiness Benchmarks

A College Readiness Benchmark is the score on a subject test that indicates a 50% chance of earning at least a "B" or a 75% chance of earning at least a "C" in the corresponding credit-bearing college course. The college courses are English Composition, Algebra, Social Sciences and Biology. English and Math scores are more highly correlated with college success than reading and science scores and are strong predictors of first year GPA in college (Bettinger, Evans & Pope, 2011).

EXPLORE TO ACT - Expected Gain

In 2014 ACT, Inc. discontinued the EXPLORE and PLAN assessments; 2015 was the last graduating class for which this data is reported.

Freshman On Track to Graduate

Students identified as "on track" have earned at least five full-year course credits (10 semester credits) and have earned no more than one semester "F" in a core course (English, math, science, or social science). Freshmen on track can be a predictor of high school success. Students who finish the ninth-grade year on track are almost four times as likely to graduate from high school as students who are not on track (Source: Illinois Report Card).

Graduation Rate

Four-year graduation rate is the number of students who graduate in four years with a regular high school diploma divided by the number of students who form the graduating class' adjusted cohort. The adjusted cohort includes all students who enter ETHS at the beginning of grade 9 and transfer in during grades 9 through 12, adjusted for the students who transfer out of ETHS in grades 9 through 12. Five-year graduation rate uses the same formula but is based on the number of students who graduate in five years. The data reported here is taken from the Illinois Report Card.

Advanced Placement Examinations

The Advanced Placement (AP) program gives ETHS students the opportunity to try college-level work while in high school. AP examinations are graded on a scale from 1 (lowest) to 5 (highest). Depending on the requirements of the post-secondary institution, students earning a 3, 4 or 5 may be awarded college credit. In August, 2015 the Illinois General Assembly passed a law requiring public institutions of higher education to provide college credit to students who received a score of 3 or higher on an AP exam.

Students Continuing In School

The National Student Clearinghouse provides college enrollment data on ETHS graduates, including the percent of students enrolled in college the fall immediately after high school, at any time during the first year after high school, and any time during the first two years after high school. The report is typically available in December. Currently the most recent report provides data on 2014 graduates who continued in a post-secondary institution within two semesters of graduating from ETHS. Data on 2015 graduates is expected in winter 2016.

Goal 1: Increase each student’s academic trajectory as demonstrated through multiple measures

100% of students will meet expected growth from EXPLORE to ACT

In 2014 ACT, Inc. discontinued the EXPLORE and PLAN assessments; 2015 was the last graduating class for which this data is reported.

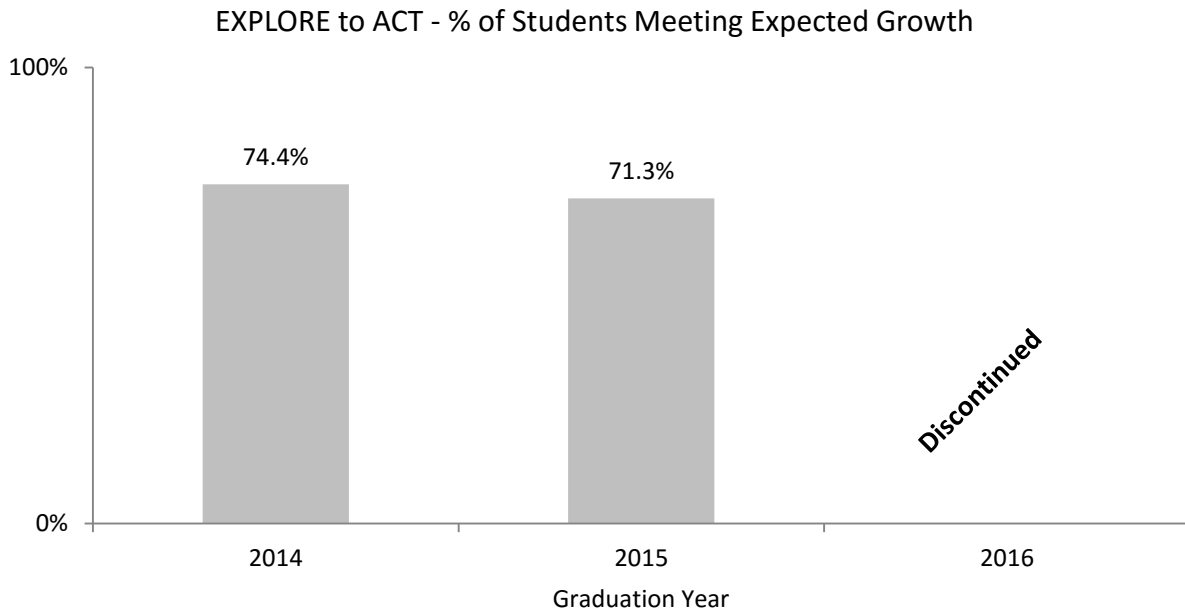

	EXPLORE to ACT - Students Meeting Expected Growth				
	2014		2015		2016
	n	% of Group	n	% of Group	
All Students	413	74.4	423	71.3	NA
Asian	15	93.8	20	83.3	
Black or African American	66	50.0	68	49.3	
Hispanic or Latino	44	49.4	43	43.9	
Two or More Races	25	75.8	20	76.9	
White	263	92.3	272	88.9	
Low Income: Free Lunch	66	48.2	60	39.0	
Low Income: Reduced-Price Lunch	23	54.8	19	63.3	
Non-Low Income	324	86.2	344	84.1	

84% of grade 11 and 12 students will be enrolled honors and AP courses

In 2015-16, 83% of grade 11 or 12 students were enrolled in at least one honors or AP course in the first semester, compared to 85% in 2014-15 and 82% in 2013-14.

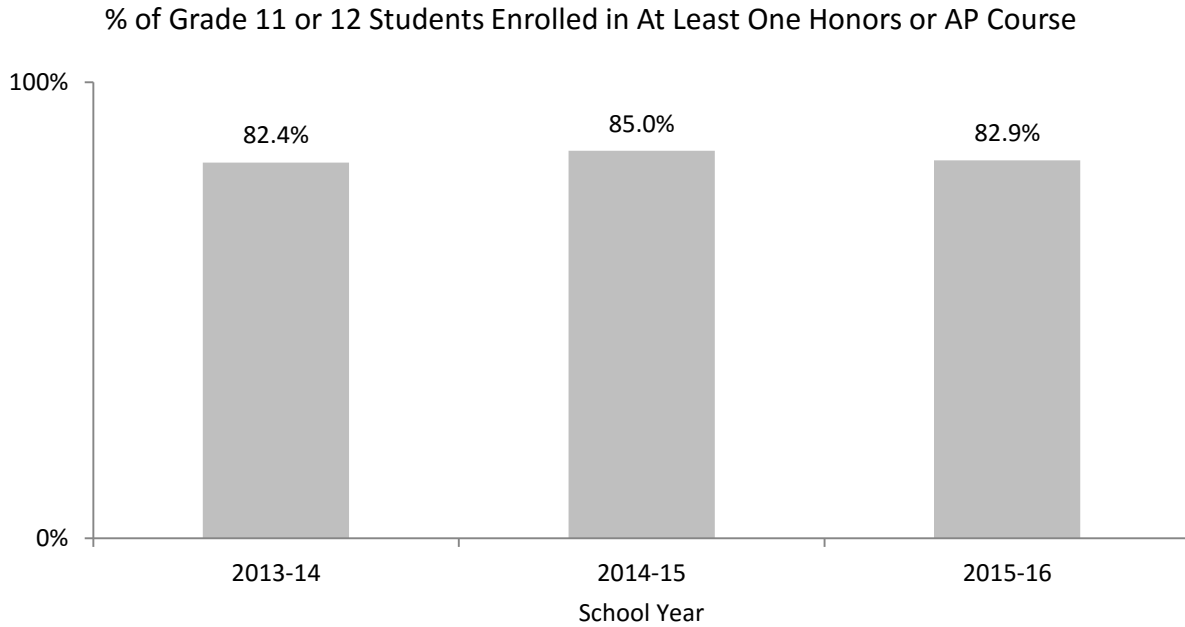

	Grade 11 or 12 Students Enrolled in At Least One Honors or AP Course					
	2013-14		2014-15		2015-16	
	n	% of Group	n	% of Group	n	% of Group
All Students	1184	82.4	1232	85.0	1241	82.9
Asian	49	96.1	61	93.8	65	87.8
Black or African American	263	63.4	273	68.6	302	68.2
Hispanic or Latino	182	77.1	185	79.1	189	76.2
Two or More Races	62	92.5	72	91.5	54	84.4
White	627	94.3	635	95.2	624	94.5
Low Income	343	64.2	369	67.8	392	69.4
Non-Low Income	841	93.1	863	95.4	849	91.1

Note: Semester 1

Percent of graduating seniors enrolled in at least one AP course

Seventy-three percent of the 2016 graduate cohort were enrolled in at least one AP course, compared to 79% of 2015 graduates and 74% of the 2014 graduates.

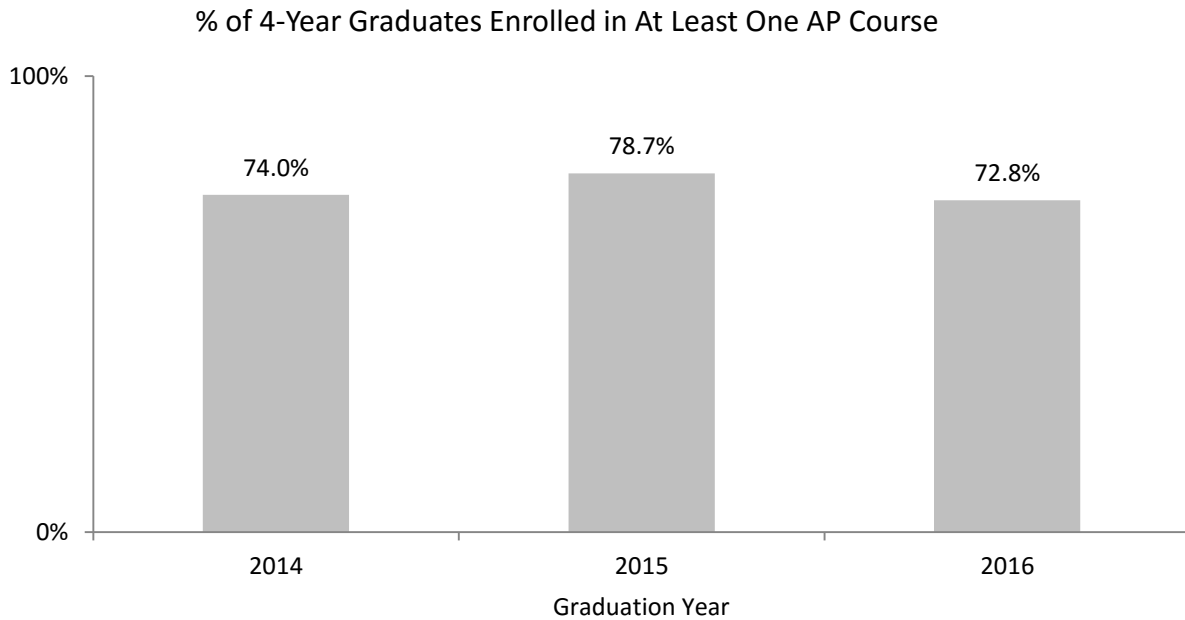

	Graduates Enrolled in At Least One AP Course					
	2014		2015		2016	
	n	% of Group	n	% of Group	n	% of Group
All Students	504	74.0	548	78.7	544	72.8
Asian	19	86.4	25	83.3	31	81.6
Black or African American	100	50.5	107	56.3	110	50.0
Hispanic or Latino	73	67.6	76	70.4	76	61.3
Two or More Races	32	82.1	24	82.8	37	77.1
White	280	89.5	315	93.2	289	91.5
Low Income	144	53.7	139	58.6	148	50.9
Non-Low Income	360	87.2	409	91.2	396	86.8

71% of graduating seniors will earn a score of 3 or higher on at least one AP exam

Of the 2016 graduating seniors that enrolled in at least one AP course, 62% earned a score of 3 or higher on at least one AP exam. This is compared to from 74% of the 2015 graduates and 66% of the 2014 graduates.

By comparison, in 2013 21.5% of Illinois graduates and 20.1% nationwide who took at least one AP exam earned a score of 3 or higher (Source: 10th Annual AP Report to the Nation).

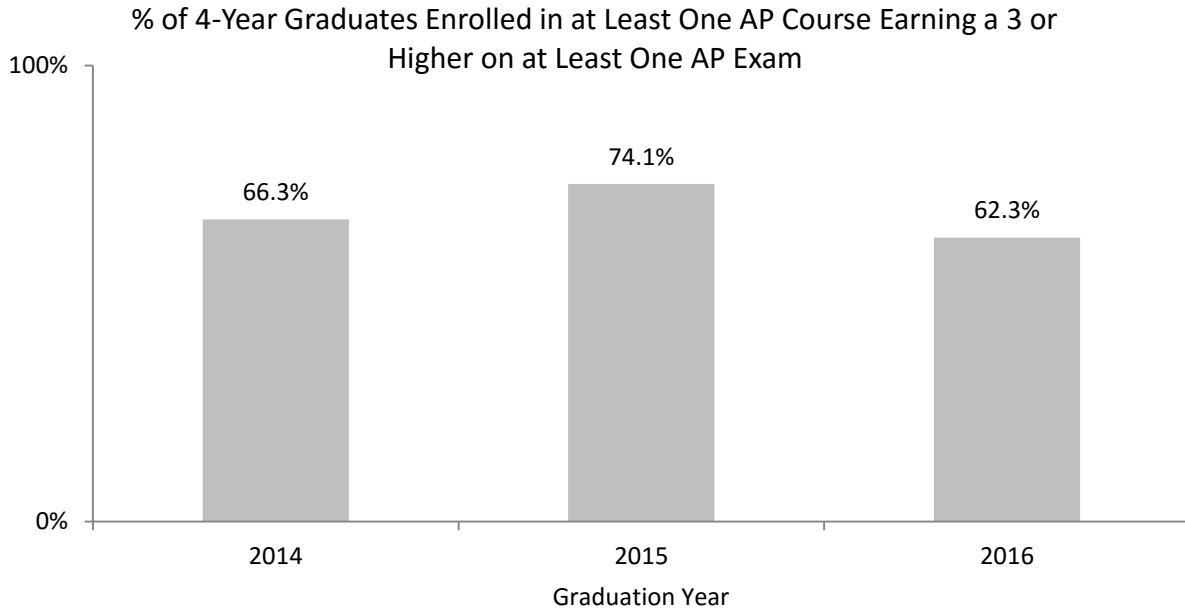

	Graduates Earning a 3 or Higher on at Least One AP Exam					
	2014		2015		2016	
	n	% of Group	n	% of Group	n	% of Group
All Students	334	66.3	406	74.1	339	62.3
Asian	14	73.7	20	80.0	22	71.0
Black or African American	30	30.0	39	36.4	36	32.7
Hispanic or Latino	34	46.6	54	71.1	48	63.2
Two or More Races	20	62.5	21	87.5	27	73.0
White	236	84.3	272	86.3	206	71.3
Low Income	56	38.9	64	46.0	58	39.2
Non-Low Income	278	77.2	342	83.6	281	71.0

80% of students will continue in a post-secondary institution within two semesters of graduating high school

According to National Student Clearinghouse data, about 84% of 2014 graduates continued in a post-secondary institution within two semesters of graduating from ETHS.

Data on 2015 graduates will be available in winter 2016.

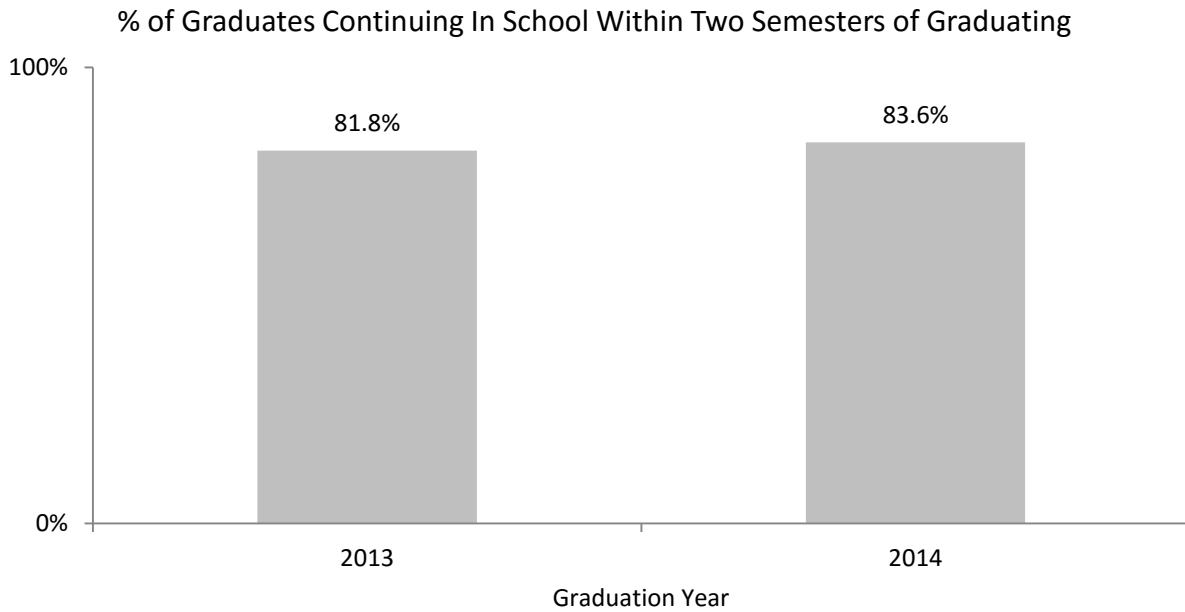

	Graduates Continuing in School Within Two Semesters of Graduating			
	2013		2014	
	n	% of Group	n	% of Group
All Students	569	81.8	559	83.6
Asian	31	91.2	19	90.5
Black or African American	162	76.1	155	78.3
Hispanic or Latino	64	71.9	83	79.8
Two or More Races	27	84.4	32	88.9
White	285	87.2	268	87.6
Female	304	86.1	273	83.7
Male	265	77.3	286	83.4

Source: National Student Clearinghouse-Student Tracker Demographics Report

100% of freshmen on track to graduate

In 2015-16 the percent of first-time grade 9 students identified as on track to graduate was 91%, compared to 92% in 2014-15. ISBE first reported this percent of freshman on track to graduate in the 2013-14 IL Report Card.

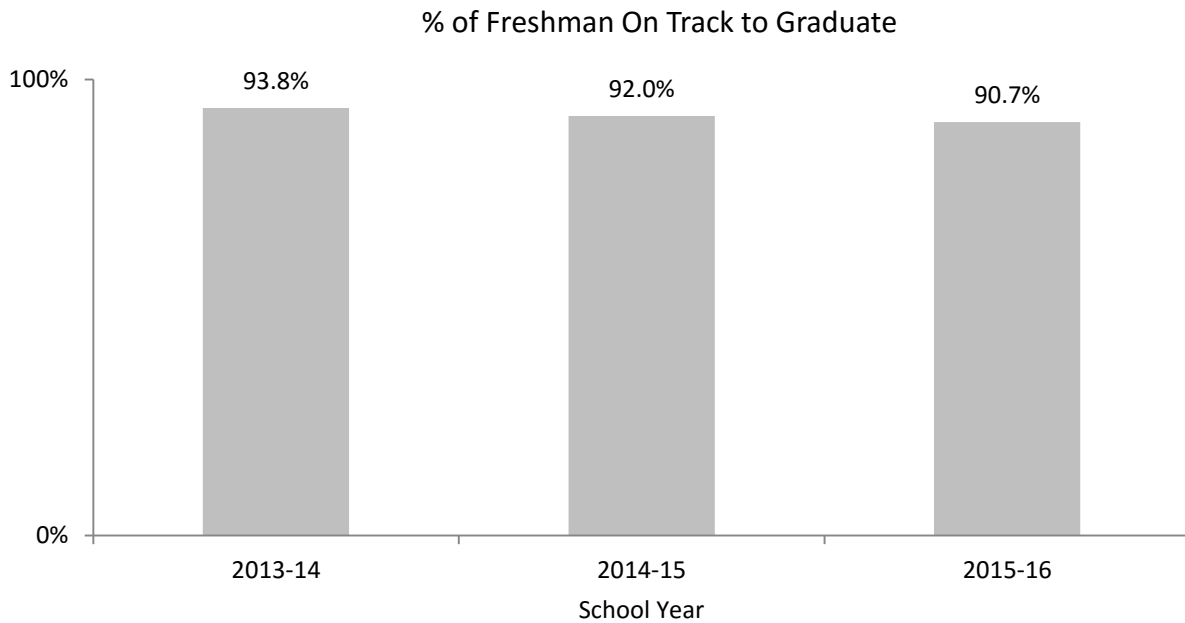

	First Time Grade 9 Students On Track To Graduation		
	2013-14	2014-15	2015-16
	% of Group	% of Group	% of Group
All Students	93.8	92.0	90.7

Source: ISBE Report Card

100% of students will meet or exceed ACT College Readiness Benchmarks in English

In 2016, 72% of graduating seniors met the ACT College Readiness Benchmark in English with a score of 18 or higher, compared to 74% in 2015 and 71% in 2014.

By comparison, only 64% of graduating seniors in Illinois and 61% of graduating seniors nationwide in 2016 met the ACT College Readiness Benchmark.

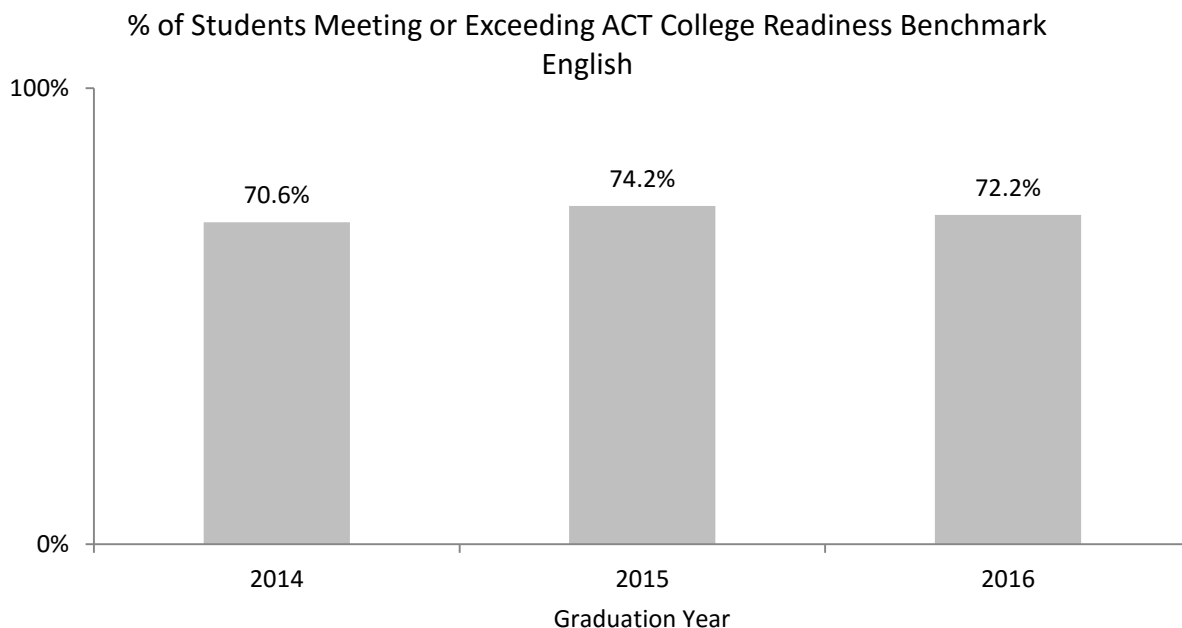

	Students Meeting or Exceeding ACT College Readiness Benchmark English (18)					
	2014		2015		2016	
	n	% of Group	n	% of Group	n	% of Group
All Students	509	70.6	541	74.2	537	72.2
Asian	19	100.0	28	90.3	31	83.8
Black or African American	93	41.9	93	44.5	100	46.1
Hispanic or Latino	55	48.7	58	51.3	63	52.5
Two or More Races	33	84.6	29	93.5	42	85.7
White	306	95.0	332	96.5	297	94.3
Low Income	125	44.6	120	45.5	131	46.1
Non-Low Income	384	87.5	421	90.5	405	88.4

100% of students will meet or exceed ACT College Readiness Benchmarks in mathematics

In 2016, 59% of graduating seniors met the ACT College Readiness Benchmark in mathematics with a score of 22 or higher, compared to 61% in 2015 and 57% in 2014.

By comparison, 41% of graduating seniors in Illinois and 41% of graduating seniors nationwide in 2016 met the ACT College Readiness Benchmark.

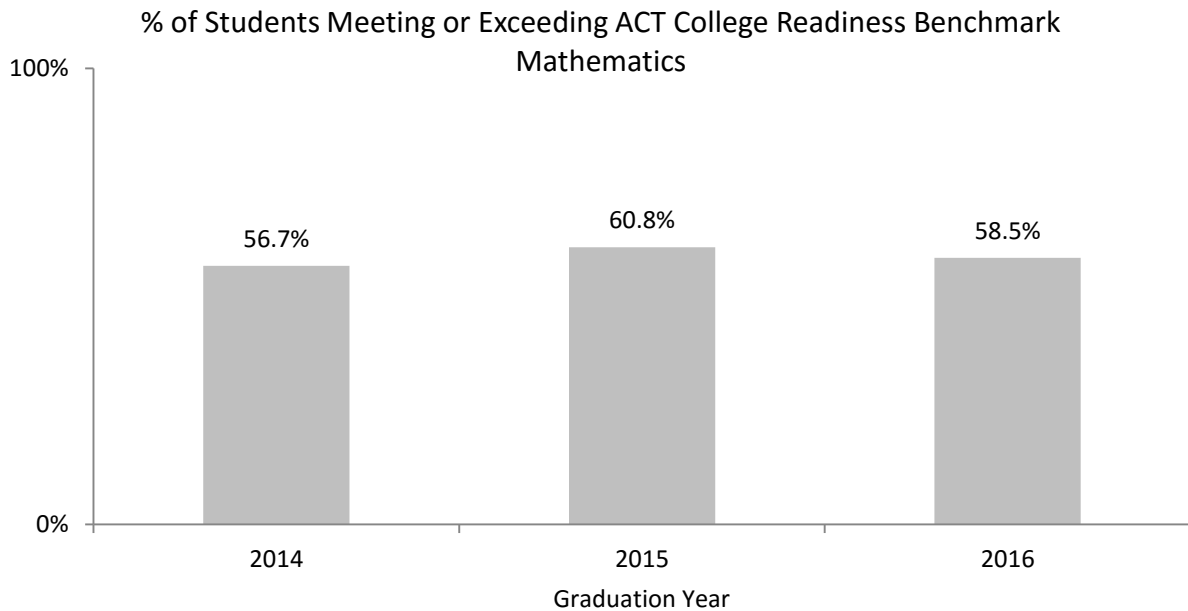

	Students Meeting or Exceeding ACT College Readiness Benchmark Math (22)					
	2014		2015		2016	
	n	% of Group	n	% of Group	n	% of Group
All Students	409	56.7	443	60.8	435	58.5
Asian	16	84.2	25	80.6	25	67.6
Black or African American	52	23.4	51	24.4	53	24.4
Hispanic or Latino	43	38.1	44	38.9	52	43.3
Two or More Races	26	66.7	22	71.0	34	69.4
White	269	83.5	301	87.5	268	85.1
Low Income	83	29.5	68	25.8	83	29.2
Non-Low Income	326	74.3	375	80.6	352	76.9

Goal 2: Provide individualized supports, programs, services and curricula to ensure that each student will demonstrate significant academic and socio-emotional growth during their experience at ETHS

100% of students will graduate

In 2016, 89% of the 2016 cohort graduated within four years, which is similar to 2015 (89%) and an increase over 2014 (88%). In 2014, 82% of students nationally graduated in four years.

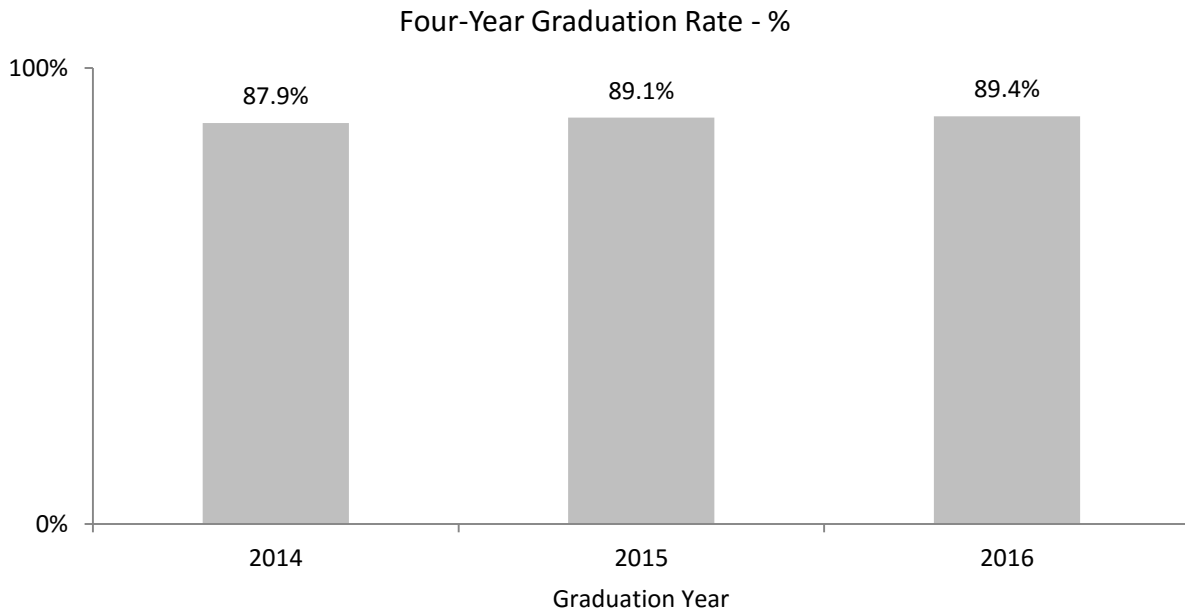

	Four-Year Graduation Rate		
	2014	2015	2016
	% of Group	% of Group	% of Group
All Students	87.9	89.1	89.4
Asian	95.7	93.8	84.6
Black or African American	83.2	80.2	83.3
Hispanic or Latino	80.3	86.4	88.6
Two or More Races	92.7	87.9	98.0
White	93.1	95.5	94.0
Low Income	81.8	80.7	83.2
Special Education	31.6	66.3	70.3

Source: ISBE Report Card

100% of students will graduate

In 2016, 92% of the 2015 cohort graduated within five years, which is an increase over 2015 (91%) and 2014 (90%) five-year graduation cohorts.

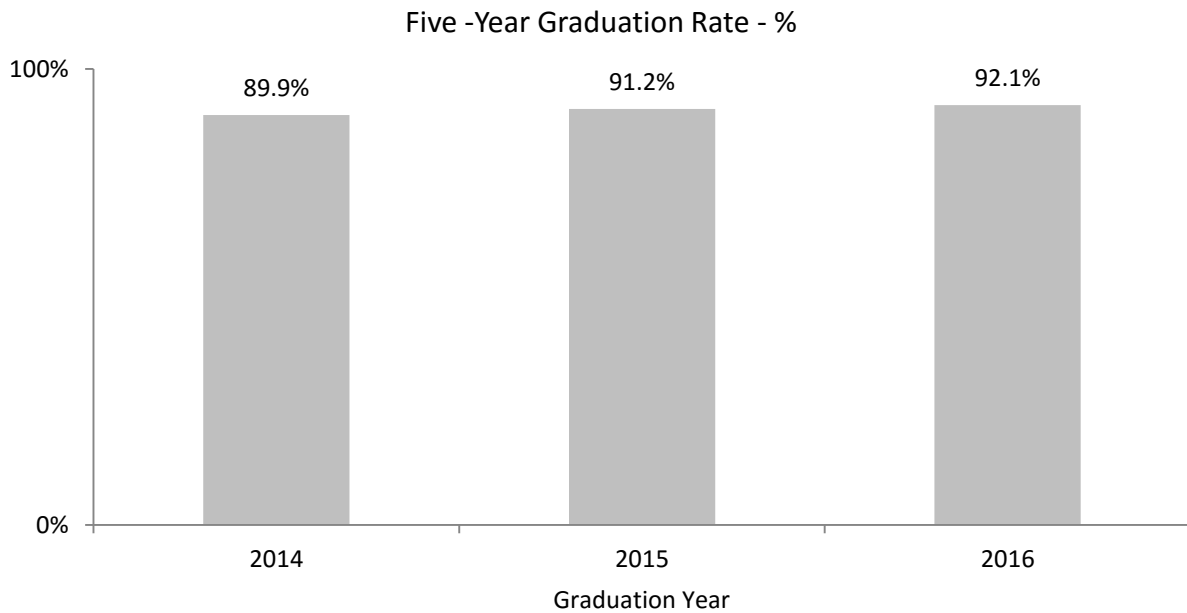

	Five-Year Graduation Rate		
	2014	2015	2016
	% of Group	% of Group	% of Group
All Students	89.9	91.2	92.1
Asian	94.3	100.0	100.0
Black or African American	86.4	86.9	87.1
Hispanic or Latino	81.9	86.6	88.0
Two or More Races	91.7	97.6	90.9
White	94.5	94.6	96.1
Low Income	89.7	87.1	86.7
Special Education	70.8	51.9	76.8

Source: ISBE Report Card

Restructured Freshman Year

Report on Students' Grade 9 Performance and Outcomes through 2015-16

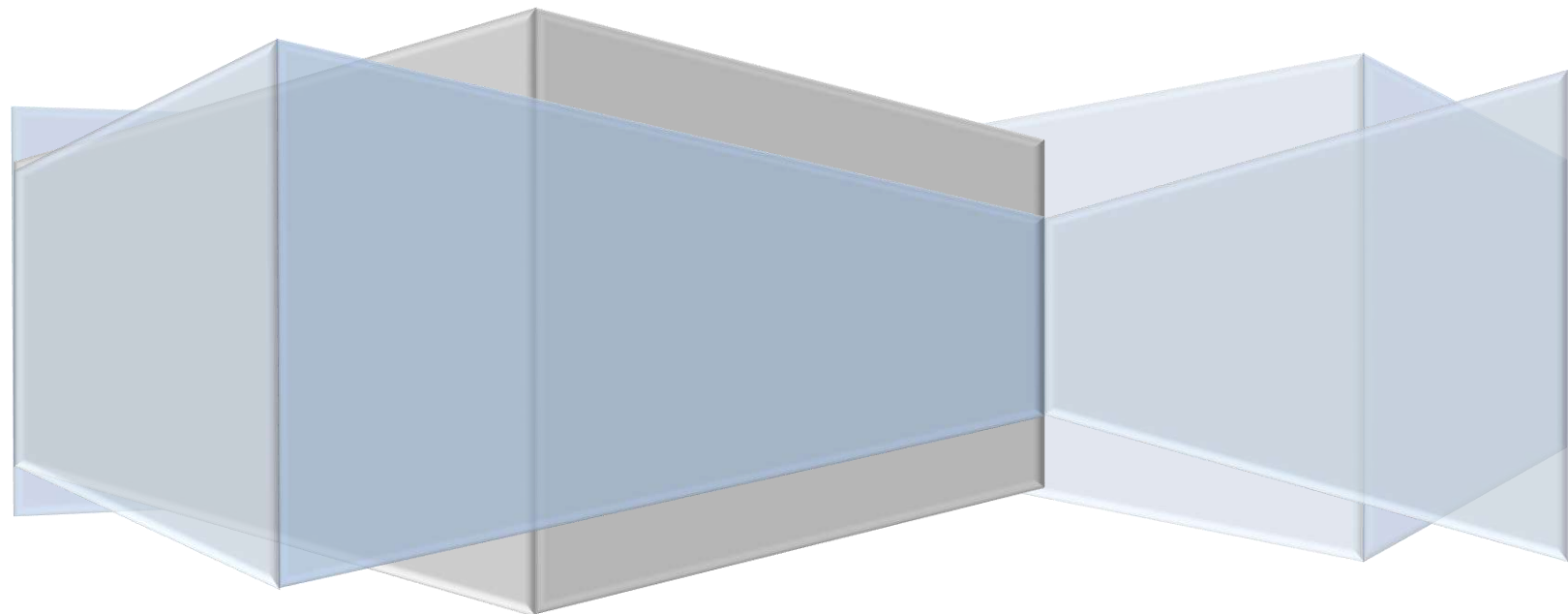

EXECUTIVE SUMMARY

Key highlights include:

Demonstrating Mastery

Historical Placement in Honors Level

- In each of the three freshman year courses, over 90% of students who would have historically been placed in and had access to an honors level course demonstrated mastery.

Historical Placement in Mixed-Honors Level

- In each of the three courses, over 80% of students who would have historically been placed in and had access to an honors level course demonstrated mastery.

Historical Placement in Mixed-Regular Level

- In each of the three courses, about one half of students who would have historically been placed in and had access to a regular level course demonstrated mastery in an honors level course. Students in the past who did not have access to a rigorous honors level curriculum now have access and are performing at a higher level.

Historical Placement in Regular Level

- In each of the three courses, about one quarter of students who would have historically been placed in and had access to a regular level course are now demonstrating mastery in an honors level course. Students in the past who did not have access to a rigorous honors level curriculum now have access and are performing at a higher level.

Long-Term Outcomes

Historical Placement in Honors Level

- The percent of students who succeeded in 5 or more honors or AP courses in grades 10-12, graduated in four years, met or exceeded ACT College Readiness Benchmark in English, and enrolled in one or more Advanced Placement (AP) course are consistent within four percentage points of the performance of the comparison cohort.
- 90% of students earned a 3 or higher on one or more AP exams, compared to 96% of the comparison cohort.

Historical Placement in Mixed-Honors Level

- The percent of students who succeeded in 5 or more honors or AP courses in grades 10-12, graduated in four years, met or exceeded ACT College Readiness Benchmark in English, and earned a 3 or higher on one or more AP exams are consistent within four percentage points of the performance of the comparison cohort.
- 92% of students enrolled in one or more AP course, compared to 87% of comparison cohort.

Historical Placement in Mixed-Regular Level

- 74% of students in the mixed-honors group succeeded in 5 or more honors or AP courses in grades 10-12, compared to 56% of the comparison cohort. This is an 18 percentage point increase.
- Four-year graduation rate is consistent within two percentage points of the performance of the comparison cohort.
- 80% of students in the mixed-honors group met or exceeded the ACT College Readiness Benchmark in English, compared to 70% of the comparison cohort. This is a 10 percentage point increase.
- 82% of students enrolled in one or more AP course, compared to 59% of comparison cohort. This is a 23 percentage point increase.
- 49% of students in the mixed-regular group earned a 3 or higher on one or more AP exams, compared to 36% of the comparison cohort. This is a 13 percentage point increase.

Historical Placement in Regular Level

- The percent of student who succeeded in 5 or more honors or AP courses in grades 10-12, graduated in four years, met or exceeded ACT College Readiness Benchmark in English, and enrolled in one or more AP course is consistent within four percentage points of the comparison cohort.
- 43% of students in the regular level group earned a 3 or higher on one or more AP exams, compared to 27% of the comparison cohort. This is a 16 percentage point increase.

Definitions

Cohorts

The 1 humanities sections and biology sections summarize findings by student cohort.

1 Humanities. Cohorts include the grade 9 students who completed both semesters of the 1 humanities English and history course in a given school year. Analyses include the comparison of the four full implementation cohorts (2012-13, 2013-14, 2014-15, and 2015-16) to the mean of the three comparison group cohorts (2008-09, 2009-10, 2010-11). This mean is called the Comparison cohort or group.

Biology. Cohorts include the grade 9 students who completed both semesters of the biology course in a given school year. Analysis includes comparing the three full implementation cohorts (2013-14, 2014-15, and 2015-16) to the mean of the three comparison group cohorts (2009-10, 2010-11 and 2011-12). This mean is called the Comparison cohort or group.

Within the report, an asterisk (*) indicates that a particular subgroup has less than 10 and therefore the n and percentage meeting a particular outcome will not be reported.

Student Placement in Courses

Before 2011-12, students were placed in courses based on their grade 8 EXPLORE reading assessment score. Beginning in 2011-12, students earning an EXPLORE score of 40 or greater were all placed in the same 1 humanities course.

1 Humanities – Historic Placement Criteria

1 Humanities Course	EXPLORE Reading National Norm
Regular	40-50
Mixed Level-Regular	51-69
Mixed Level-Honors	70-94
Honors	>=95

Before 2012-13, grade 9 students were placed in courses based on their grade 8 EXPLORE reading and math assessment scores. Students earning an EXPLORE reading score below 50 did not take the biology course while in grade 9. Beginning in 2012-13, grade 9 students earning an EXPLORE score of 50 or greater were placed in the same biology course.

Biology – Historic Placement Criteria

Biology Course	EXPLORE Reading National Norm
No Biology Course (grade 9)	<50
Regular	50-66
Mixed Level-Regular	67-74
Mixed Level-Honors	75-89
Honors	>=90

The 2012-13 freshman cohort is the first cohort to experience both the restructured 1 humanities and biology courses. This is the first cohort to graduate (2016) and is the only cohort that has long term outcome available to report.

Demonstrating Mastery in Grade 9

All students now have access to a challenging, guaranteed curriculum. This includes students who, in the past, would have been placed in a regular or mixed-level regular course. To earn honors credit is to meet the course's high expectations and demonstrate mastery of the skills taught. Earning honors credit is not an outcome, but instead part of the implementation of the program. Students who demonstrated mastery in a course were able to demonstrate the depth and breadth of their skills by successfully completing a series of assessments and by earning a course grade of C or better.

Long-Term Outcomes

Long term outcomes presented in this report include four-year graduation rate, ACT College Readiness Benchmark in English, and Advanced Placement course enrollment and performance.

Students Succeeding in Honors/AP Courses. After grade 9 there are 6 required semesters of English and 4 required semesters of history for a total of 10 required semesters between grades 10 and 12. Students succeeding in honors or AP courses is defined as students who enrolled in and earned a C or better in one or more semesters of an honors or AP course.

Four Year Graduation Rate. Four-year graduation rate is the number of students who graduate in four years with a regular high school diploma divided by the number of students who form the graduating class' adjusted cohort. The adjusted cohort includes all students who enter ETHS at the beginning of grade 9 and transfer in during grades 9 through 12, adjusted for the students who transfer out of ETHS in grades 9 through 12. This reports includes students from the 2012-13 freshman cohort who graduated in 2016.

ACT English Meeting College Readiness Benchmarks. The ACT English College Readiness Benchmark is the score on the English subject test that indicates a 50% chance of earning at least a "B" or a 75% chance of earning at least a "C" in the corresponding credit-bearing college course, or English Composition. The ACT College Readiness Benchmark for English is a score of 18.

Advanced Placement Course Enrollment. A primary goal of the restructured freshman year initiative is to create pathways for more students to take honors and advanced classes at ETHS. Advanced Placement (AP) course enrollment reports the percent of a graduated cohort who took at least one AP course by the time they graduate. This report provides data on the 2012-13 freshman cohort that graduated in 2016.

Advanced Placement – Students Earning a 3 or Higher on One or More Exam. Of the students that were enrolled in at least 1 AP courses by the time they graduated, this statistic reports the percent who earned a 3 or higher on one or more exams.

Grade 9 Students Demonstrating Mastery – ENGLISH

The percent of students demonstrating mastery in at least one semester of 1 humanities English has increased steadily since 2012-13. Overall, 78% of students demonstrated mastery in at least one semester in 2015-16, compared to 66% in 2012-13.

In 2015-16, 25% of the students who would have historically been placed in a regular level course and 53% of students who would have been placed in a mixed-regular level course demonstrated mastery in at least one semester of their English course, which is slightly less than the 2012-13 cohort (31% and 54% respectively). 87% of students historically placed in a mixed-honors level course demonstrated mastery, which is an increase over 2012-13 (82%).

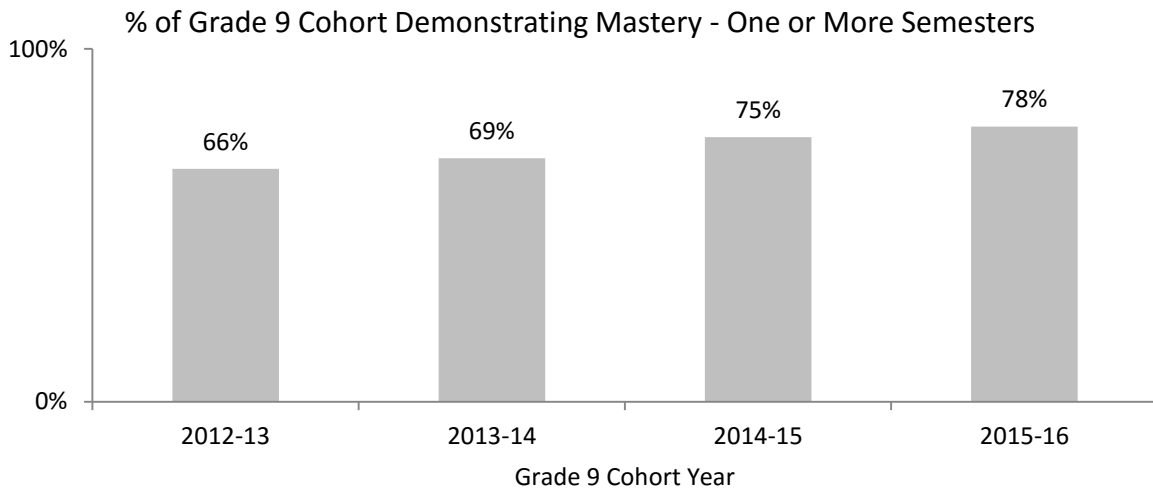

	Number and Percent of Students Demonstrating Mastery							
	2012-13		2013-14		2014-15		2015-16	
	n	% of Group	n	% of Group	n	% of Group	n	% of Group
All Students	425	66%	450	69%	501	75%	511	78%
Regular	36	31%	30	28%	47	38%	10	25%
Mixed-Regular	79	54%	68	56%	61	63%	50	53%
Mixed-Honors	155	82%	238	87%	242	86%	289	87%
Honors	134	93%	79	92%	85	96%	117	93%
Female	245	71%	267	75%	260	79%	271	84%
Male	180	60%	183	62%	241	71%	240	74%
Asian	21	80%	28	90%	33	87%	34	82%
Black or Afr American	62	37%	81	47%	74	50%	85	57%
Hispanic or Latino	45	45%	49	47%	66	65%	71	68%
Two or More Races	32	78%	10	50%	19	66%	*	*
White	264	87%	281	88%	307	87%	314	90%
Low Income	72	32%	106	44%	110	51%	100	54%
Non-Low Income	353	85%	344	84%	391	86%	411	89%

Grade 9 Students Demonstrating Mastery – HISTORY

The percent of students demonstrating mastery in at least one semester 1 humanities history has increased steadily since 2012-13. Overall, 77% of students demonstrated mastery in at least one semester in 2015-16, compared to 66% in 2012-13.

In 2015-16, 49% of the students who would have historically been placed in a mixed-regular level course demonstrated mastery in at least one semester of their history course, which is slightly less than the 2012-13 cohort of 51%. 86% of students historically placed in a mixed-honors level course demonstrated mastery, which is an increase over the 2012-13 cohort (85%).

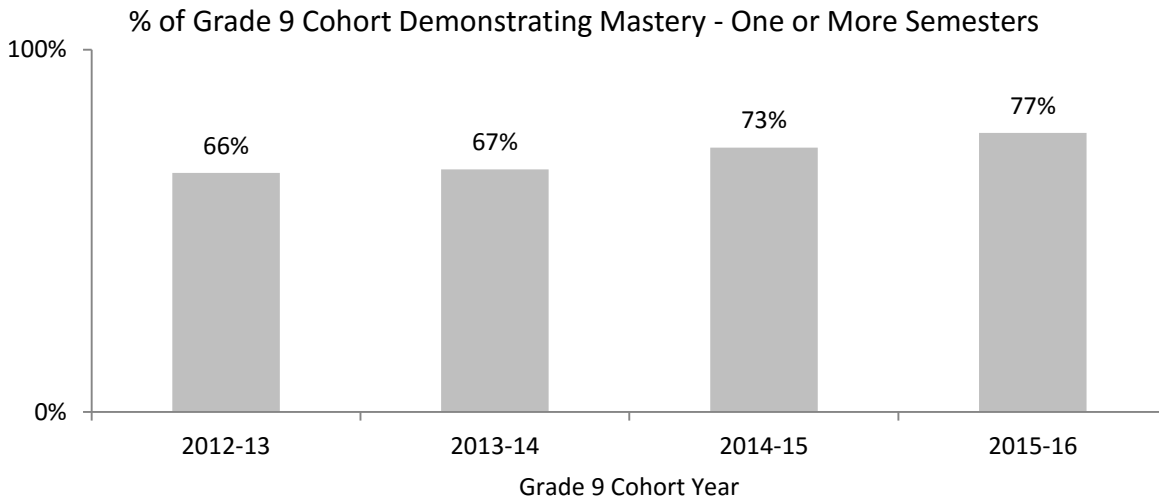

	Number and Percent of Students Demonstrating Mastery							
	2012-13		2013-14		2014-15		2015-16	
	n	% of Group	n	% of Group	n	% of Group	n	% of Group
All Students	423	66%	438	67%	489	73%	501	77%
Regular	34	30%	23	21%	39	32%	*	*
Mixed-Regular	75	51%	58	47%	54	55%	46	49%
Mixed-Honors	160	85%	242	89%	245	87%	284	86%
Honors	136	93%	79	92%	87	99%	118	93%
Female	239	70%	258	72%	248	76%	266	82%
Male	184	61%	180	62%	241	70%	235	72%
Asian	21	81%	26	83%	30	79%	34	83%
Black or Afr American	58	35%	69	40%	70	47%	80	53%
Hispanic or Latino	43	43%	46	44%	57	56%	67	65%
Two or More Races	33	80%	10	50%	20	69%	*	*
White	267	88%	286	90%	310	88%	314	91%
Low Income	68	30%	95	36%	100	46%	93	50%
Non-Low Income	355	85%	343	85%	389	86%	408	88%

Grade 9 Students Demonstrating Mastery – BIOLOGY

The percent of grade 9 students demonstrating mastery in at least one semester in biology has increased steadily since 2013-14. Overall, 77% of students demonstrated mastery in at least one semester in 2015-16, compared to 69% in 2013-14.

In 2015-16, 27% of the students who would have historically been placed in a regular level course demonstrated mastery in at least one semester of their biology course, compared to 35% in the 2013-14 cohort. 58% of students historically placed in mixed-regular level course demonstrated mastery in 2015-16, compared to 69% in 2013-14. 84% of students historically placed in a mixed-honors level course and 96% of students historically placed in an honors level course demonstrated mastery, compared to 90% and 94% respectively in the 2013-14 cohort.

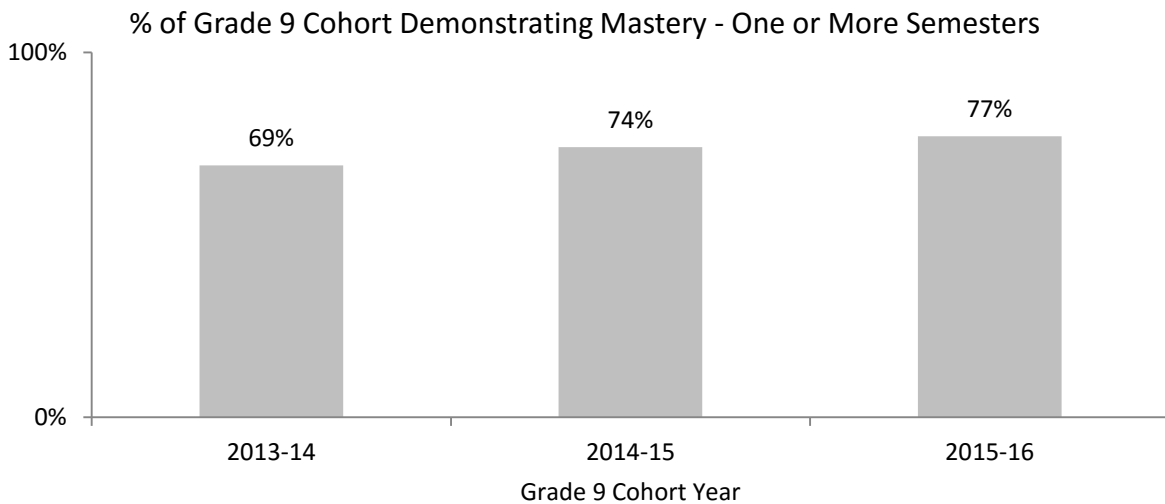

	Number and Percent of Students Demonstrating Mastery					
	2013-14		2014-15		2015-16	
	n	% of Group	n	% of Group	n	% of Group
All Students	398	69%	445	74%	435	77%
Regular	59	35%	58	37%	20	27%
Mixed-Regular	22	69%	57	79%	32	58%
Mixed-Honors	147	90%	118	85%	152	84%
Honors	144	94%	154	95%	200	96%
Female	239	75%	221	77%	235	82%
Male	159	62%	224	72%	200	72%
Asian	24	80%	29	82%	31	84%
Black or Afr American	60	45%	51	43%	50	47%
Hispanic or Latino	32	41%	57	65%	53	62%
Two or More Races	*	*	21	84%	*	*
White	273	89%	285	86%	295	90%
Low Income	75	39%	81	47%	60	46%
Non-Low Income	323	84%	364	84%	375	86%

**Grades 10~12 Students Succeeding in Honors and/or AP Courses
(required English and History/Social Science courses)**

Overall, 80% of students took 5-10 semesters of honors or AP courses and earned a C or better in those courses. This is similar to the comparison cohorts of 81%.

A greater percentage of students from the 2012-13 cohort who would have historically been placed in a regular (48%) or mixed-regular (74%) level course took 5 or more semesters of an honors or AP course and earned a C or better in those courses. This is a higher percentage than the comparison cohorts, 45% and 56% respectively.

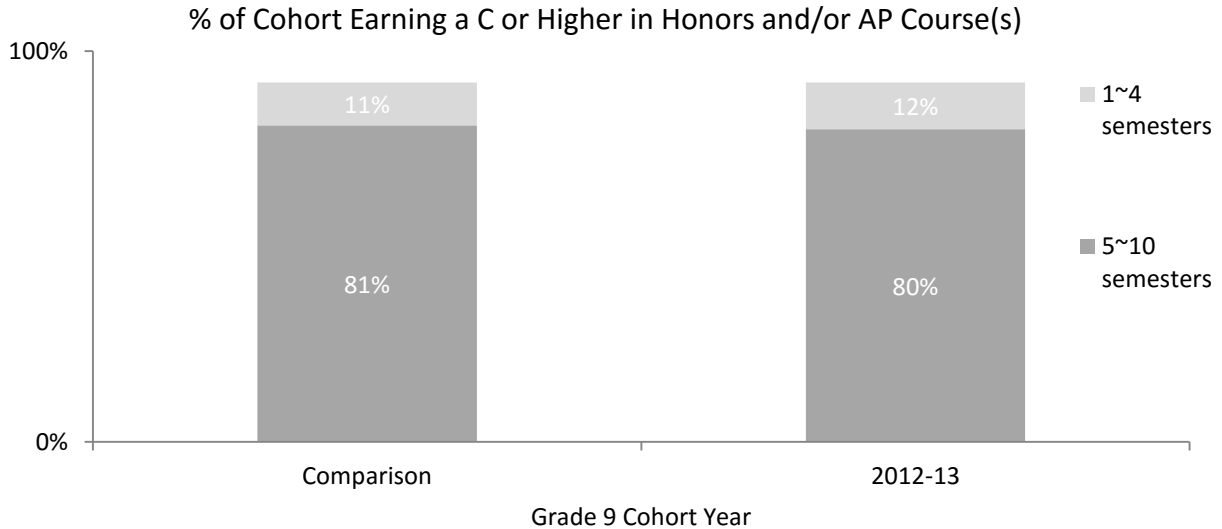

	Comparison Cohorts		2012-13 Cohort	
	Number of Semesters		Number of Semesters	
	1~4	5~10	1~4	5~10
All Students	11%	81%	12%	80%
Regular	29%	45%	29%	48%
Mixed-Regular	27%	56%	17%	74%
Mixed-Honors	6%	91%	3%	95%
Honors	2%	97%	6%	93%
Female	11%	85%	12%	83%
Male	13%	77%	11%	76%
Asian	6%	94%	4%	92%
Black or Afr American	27%	56%	20%	62%
Hispanic or Latino	20%	62%	23%	57%
Two or More Races	6%	89%	13%	87%
White	5%	93%	4%	92%
Low Income	27%	55%	26%	50%
Non-Low Income	6%	91%	5%	92%

Four-Year Graduation Rate

Most of the students (99%) from the 2012-13 cohort graduated within 4 years. This is consistent with the comparison cohorts.

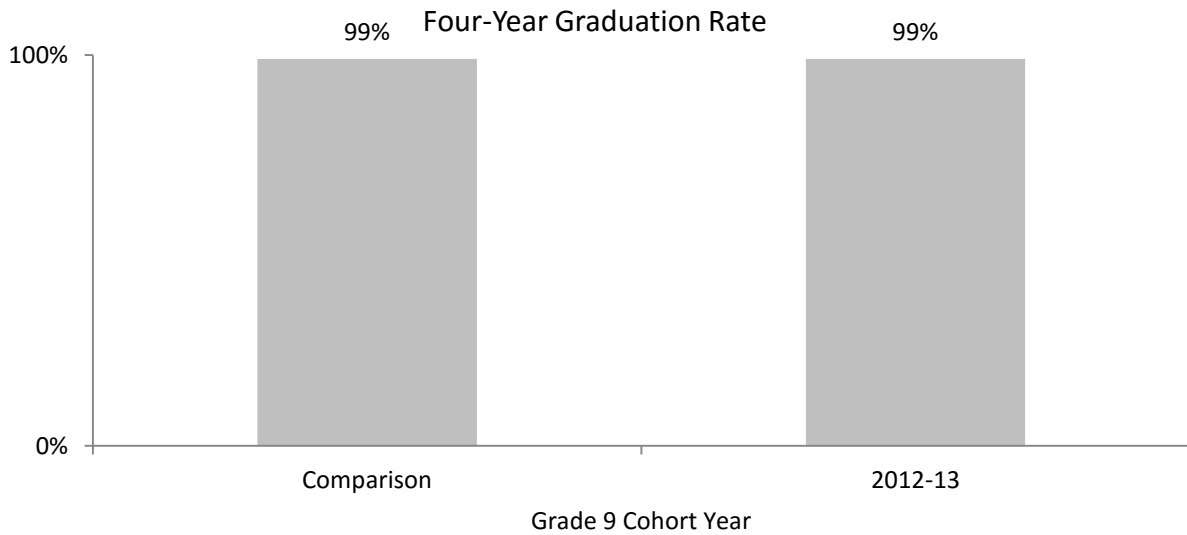

	Comparison Cohorts		Graduation Rate
All Students	99%		99%
Regular	99%		96%
Mixed-Regular	98%		100%
Mixed-Honors	99%		99%
Honors	100%		100%
Female	100%		99%
Male	99%		99%
Asian	100%		87%
Black or Afr American	99%		99%
Hispanic or Latino	99%		98%
Two or More Races	98%		100%
White	100%		100%
Low Income	98%		98%
Non-Low Income	100%		99%

ACT – English – Meeting or Exceeding College Readiness Benchmark

Overall, 83% of students met or exceeded the ACT English College Readiness Benchmark of 18, compared to 85% of the comparison cohorts.

In the 2012-13 cohort, 43% of the students who would have historically been placed in a regular level course met the college readiness benchmark, which is the same as the comparison cohorts. 80% of students who would have been placed in a mixed-regular level course and 98% of students who would have been placed in a mixed-honors level course met the college readiness benchmark. This is an increase over the comparison cohorts of 70% and 95% respectively.

% of Students Meeting/Exceeding ACT English College Readiness Benchmark

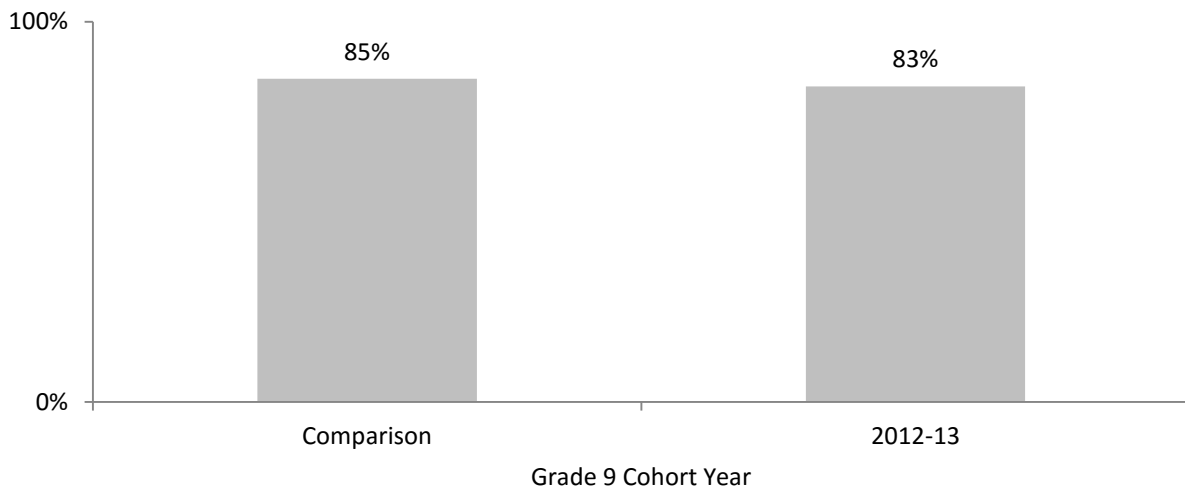

	Comparison Cohorts		2012-13
All Students	85%		83%
Regular	43%		43%
Mixed-Regular	70%		80%
Mixed-Honors	95%		98%
Honors	100%		99%
Female	85%		85%
Male	85%		81%
Asian	95%		91%
Black or Afr American	65%		61%
Hispanic or Latino	67%		61%
Two or More Races	89%		92%
White	97%		98%
Low Income	62%		55%
Non-Low Income	95%		96%

ACT – Percent Meeting/Exceeding Composite Score of 24 or Greater

More selective colleges and universities (defined as most competitive, highly competitive, and very competitive by Barron’s Profile of American Colleges) generally report median freshman ACT Composite scores in the range of 24 or greater.

Overall, 58% of students had an ACT Composite score of 24 or greater, compared to 61% of the comparison cohorts and 26% nationally.

% of Students Meeting/Exceeding ACT Composite Score of 24 or Greater

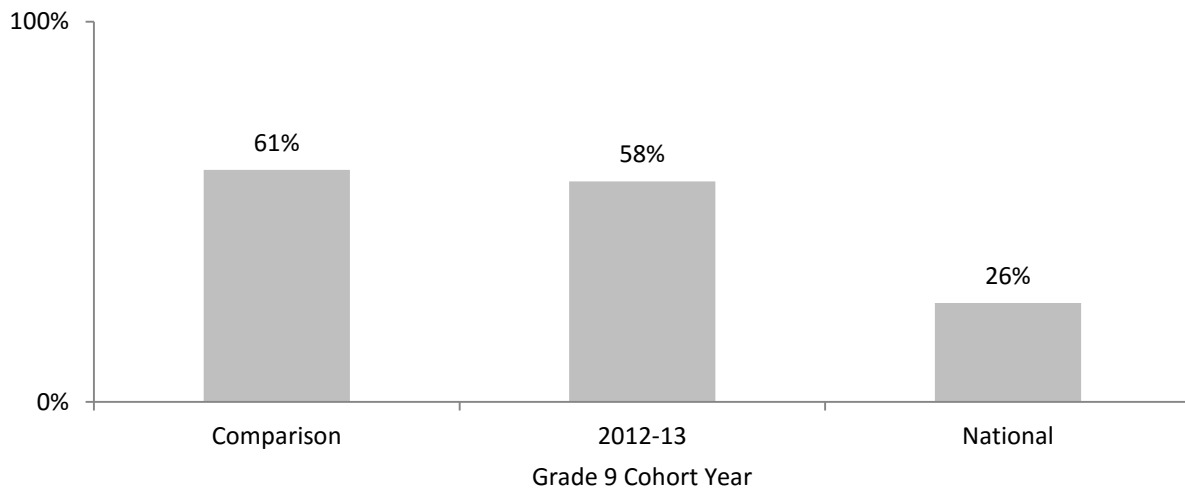

	Comparison Cohorts		2012-13
All Students	61%		58%
Regular	7%		12%
Mixed-Regular	22%		39%
Mixed-Honors	72%		75%
Honors	98%		92%
Female	58%		57%
Male	64%		59%
Asian	69%		64%
Black or Afr American	19%		19%
Hispanic or Latino	31%		33%
Two or More Races	71%		66%
White	85%		83%
Low Income	20%		15%
Non-Low Income	77%		78%
<i>National Comparison</i>			26%

ACT – Percent Meeting/Exceeding Composite Score of 27 or Greater

Highly selective colleges and universities (defined as highly competitive and very competitive by Barron’s Profile of American Colleges) generally report median freshman ACT Composite scores in the range of 27 or greater.

Overall, 45% of students had an ACT Composite score of 27 or greater, compared to 44% of the comparison cohorts and 14% nationally.

% of Students Meeting/Exceeding ACT Composite Score of 27 or Greater

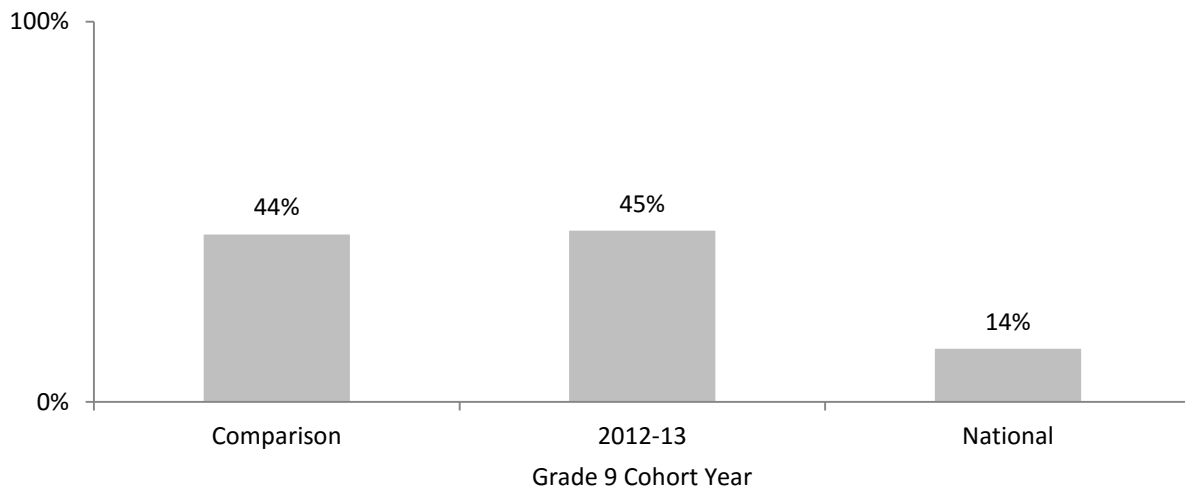

	Comparison Cohorts		2012-13
All Students	44%		45%
Regular	1%		2%
Mixed-Regular	6%		21%
Mixed-Honors	45%		56%
Honors	89%		85%
Female	43%		45%
Male	44%		45%
Asian	45%		50%
Black or Afr American	8%		9%
Hispanic or Latino	15%		27%
Two or More Races	49%		50%
White	66%		67%
Low Income	9%		8%
Non-Low Income	58%		62%
<i>National Comparison</i>			<i>14%</i>

Advanced Placement Course Enrollment-One or More Course

Overall, 80% of students enrolled in one or more AP course by the time they graduated, compared to 79% of the comparison cohorts.

In the 2012-13 cohort, 41% of the students who would have historically been placed in a regular level course enrolled in one or more AP course by the time they graduated, which is slightly lower than the comparison cohorts (44%). 82% of students who would have been placed in a mixed-regular level course and 92% of students who would have been placed in a mixed-honors level course enrolled in one or more AP course. This is an increase over the comparison cohorts of 59% and 87% respectively.

% of Students Enrolled in One or More AP Course

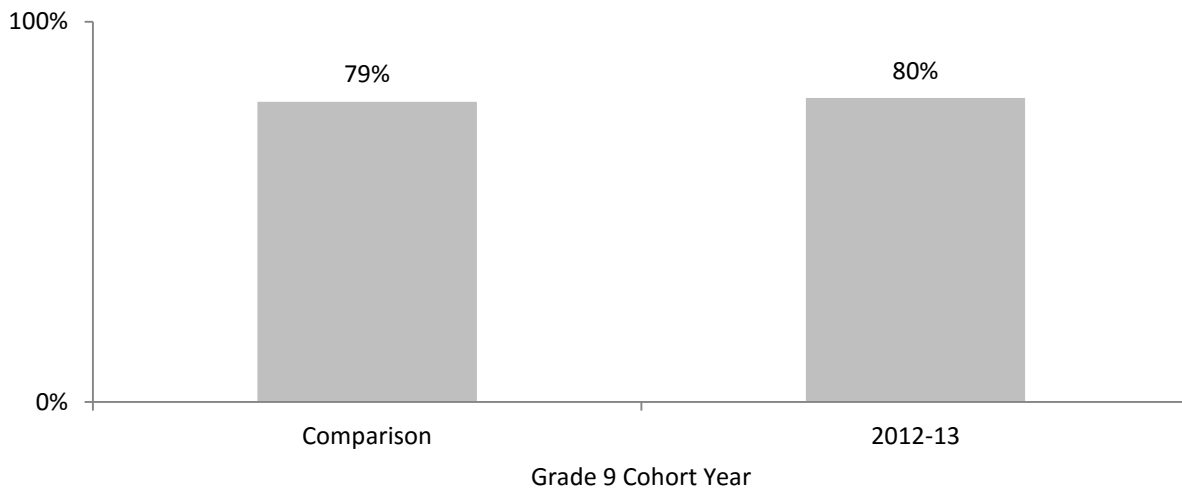

	Comparison Cohorts		2012-13
All Students	79%		80%
Regular	44%		41%
Mixed-Regular	59%		82%
Mixed-Honors	87%		92%
Honors	98%		96%
Female	82%		85%
Male	76%		74%
Asian	97%		96%
Black or Afr American	55%		58%
Hispanic or Latino	69%		67%
Two or More Races	77%		87%
White	91%		91%
Low Income	59%		53%
Non-Low Income	87%		92%

Advanced Placement Exams-Students Earning a 3 or Higher on One or More Exam

Overall, 68% of students who enrolled in one or more AP course earned a 3 or higher on one or more AP exams, compared to 72% of the comparison cohorts.

In the 2012-13 cohort, 43% of the students who would have historically been placed in a regular level course earned a 3 or higher on one or more exams, which is an increase over the comparison cohorts (27%). 49% of students who would have been placed in a mixed-regular level course and 71% of students who would have been placed in a mixed-honors level course earned a 3 or higher on one or more exams, compared to 36% and 75% respectively of the comparison cohorts.

% of Exam-Takers Earning One or More 3 or Higher

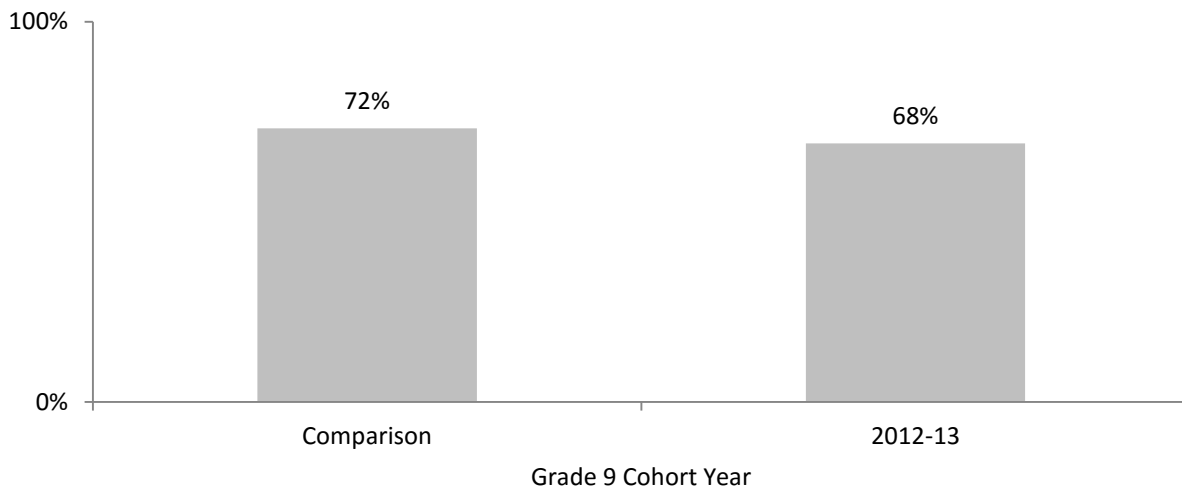

	Comparison Cohorts		2012-13
All Students	72%		68%
Regular	27%		43%
Mixed-Regular	36%		49%
Mixed-Honors	75%		71%
Honors	96%		90%
Female	72%		72%
Male	73%		63%
Asian	80%		73%
Black or Afr American	37%		36%
Hispanic or Latino	59%		75%
Two or More Races	68%		73%
White	84%		77%
Low Income	43%		42%
Non-Low Income	80%		76%