

SQUARE

$P = 4s$
 $A = s^2$

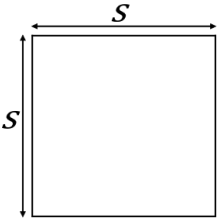

RECTANGLE

$P = 2a + 2b$
 $A = ab$

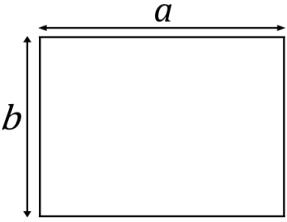

CIRCLE

$P = 2\pi r$
 $A = \pi r^2$

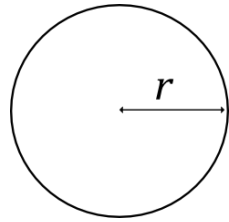

TRIANGLE

$P = a + b + c$
 $A = \frac{1}{2}bh$

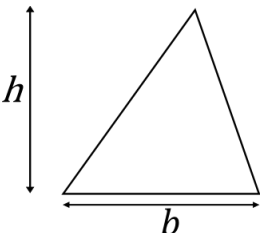

PARALLELOGRAM

$P = 2a + 2b$
 $A = bh$

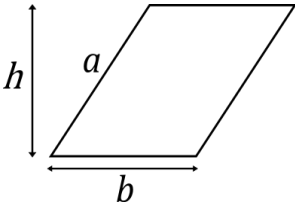

CIRCULAR SECTOR

$L = \pi r \frac{\theta}{180^\circ}$
 $A = \pi r^2 \frac{\theta}{360^\circ}$

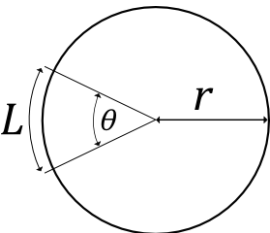

PYTHAGOREAN THEOREM

$a^2 + b^2 = c^2$
 $c = \sqrt{a^2 + b^2}$

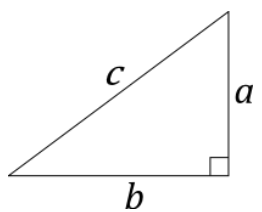

CIRCULAR RING

$A = \pi(R^2 - r^2)$

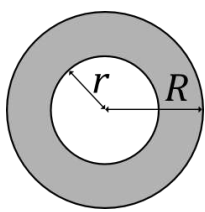

SPHERE

$S = 4\pi r^2$
 $V = \frac{4\pi r^3}{3}$

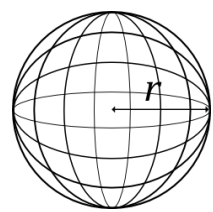

TRAPEZOID

$P = a + b + c + d$
 $A = h \frac{a+b}{2}$

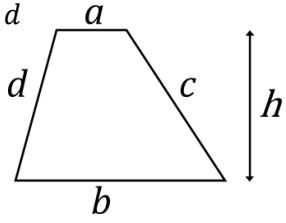

RECTANGULAR BOX

$A = 2ab + 2ac + 2bc$
 $V = abc$

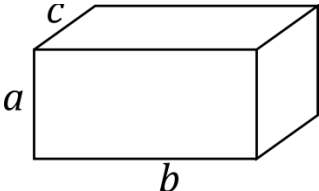

RIGHT CIRCULAR CONE

$A = \pi r^2 + \pi rs$
 $s = \sqrt{r^2 + h^2}$
 $V = \frac{1}{3}\pi r^2 h$

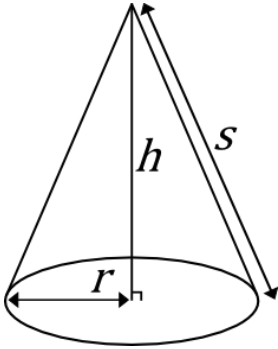

CUBE

$A = 6l^2$
 $V = l^3$

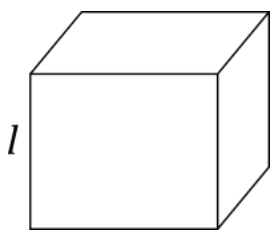

CYLINDER

$A = 2\pi r(r + h)$
 $V = \pi r^2 h$

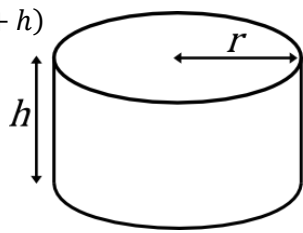

FRUSTUM OF A CONE

$V = \frac{1}{3}\pi h(r^2 + rR + R^2)$

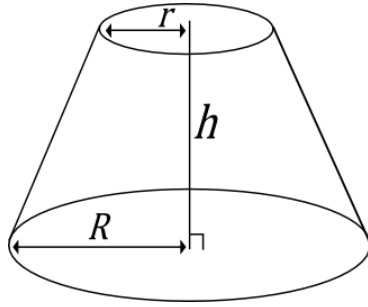

EEWeb.com
Electrical Engineering Community

- Latest News
- Professional Networking
- Engineering Community
- Personal Profiles and Resumes
- Online Toolbox
- Community Blogs and Projects
- Technical Discussions
- Find Jobs and Events