



S U M M A T I V E

Grade 8 Science

Alabama Educator Instructional Supports

Alabama Course of Study Standards

August 31, 2020

Introduction

The *Alabama Instructional Supports: Science* is a companion to the 2015 *Alabama Course of Study: Science*. Instructional supports are foundational tools that educators may use to help students become independent learners as they build toward mastery of the *Alabama Course of Study* content standards. **Instructional supports are designed to help educators engage their students in exploring, explaining, and expanding their understanding of the content standards.**

The content standards contained within the course of study may be accessed on the Alabama State Department of Education (ALSDE) website at www.alsde.edu. When examining these instructional supports, educators are reminded that content standards indicate minimum content—what all students should know and be able to do by the end of each grade level or course. Local school systems may have additional instructional or achievement expectations and may provide instructional guidelines that address content sequence, review, and remediation.

The instructional supports are organized by standard. Each standard’s instructional support includes a statement of the content standard, guiding questions with connections to three-dimensional learning, key academic terms, and additional resources.

Content Standards

The content standards are the statements from the 2015 *Alabama Course of Study: Science* that define what all students should know and be able to do at the conclusion of a given grade level or course. Content standards contain minimum required content and complete the phrase “Students will _____.”

Guiding Questions with Connections to the Three Dimensions

Guiding questions are designed to create a framework for the given standards and to engage students in exploring, explaining, and expanding their understanding of the content standards provided in the 2015 *Alabama Course of Study: Science*. Therefore, each guiding question is written to help educators convey important concepts within the standard. By utilizing guiding questions, educators are engaging students in investigating, analyzing, and demonstrating knowledge of the underlying concepts reflected in the standard.

An emphasis is placed on the integration of the Three Dimensions of learning as described in the 2012 National Research Council publication *A Framework for K–12 Science Education: Practices, Crosscutting Concepts, and Core Ideas*.

Each content standard in the 2015 *Alabama Course of Study: Science* blends knowledge and skills linked to science and engineering that all students should know and be able to do by the end of high school.

The Three Dimensions are the same for all grade levels and are described below.

1. Scientific and Engineering Practices are skills and tools used by students to investigate phenomena, develop and use models, design and build systems, and construct arguments based on evidence to solve problems in the world in which they live.
2. Crosscutting Concepts are unifying conceptual threads that encourage students to connect scientific and engineering ideas across the domains of science.
3. Disciplinary Core Ideas in the four domains of Physical Science, Life Science, Earth and Space Sciences, and Engineering Technology include relevant content that provides students with foundational scientific knowledge.

Each guiding question includes a representative set of sample activities and examples that can be used in the classroom. The set of activities and examples is not intended to include all the activities and examples that would be relevant to the standard.

Key Academic Terms

These academic terms are derived from the standards and are to be incorporated into instruction by the educator and used by the students.

Additional Resources

Additional resources are included that are aligned to the standard and may provide additional instructional support to help students build toward mastery of the designated standard. Please note that while every effort has been made to ensure all hyperlinks are working at the time of publication, web-based resources are impermanent and may be deleted, moved, or archived by the information owners at any time and without notice. Registration is not required to access the materials aligned to the specified standard. Some resources offer access to additional materials by asking educators to complete a registration. While the resources are publicly available, some websites may be blocked due to Internet restrictions put in place by a facility. Each facility's technology coordinator can assist educators in accessing any blocked content. Sites that use Adobe Flash may be difficult to access after December 31, 2020, unless users download additional programs that allow them to open SWF files outside their browsers.

Your Feedback

ALSDE and DRC value your feedback. The last two pages of this document contain a survey about your experience using the Alabama Educator Instructional Supports. Once you have had a chance to use and become familiar with these Instructional Supports, please take the time to fill out the survey. The Instructional Supports, as well as your responses to the survey, will be discussed during an educator review meeting in summer 2021.

Printing This Document

It is possible to use this entire document without printing it. However, if you would like to print this document, you do not have to print every page. First, identify the page ranges of the standards or domains that you would like to print. Then, in the print pop-up command screen, indicate which pages you would like to be printed.

Grade 8
Matter and Its Interactions
8.PS.1 Analyze patterns within the periodic table to construct models (e.g., molecular-level models, including drawings; computer representations) that illustrate the structure, composition, and characteristics of atoms and molecules.

Connections to *A Framework for K–12 Science Education: Practices, Crosscutting Concepts, and Core Ideas:*

Focus for Scientific and Engineering Practice(s):

- Developing and Using Models
- Analyzing and Interpreting Data
- Using Mathematics and Computational Thinking

Focus for Crosscutting Concept(s):

- Patterns
- Scale, Proportion, and Quantity
- Structure and Function
- Stability and Change

Focus for Disciplinary Core Idea(s):

- Structure and Properties of Matter

Key Academic Terms:

molecular model, atomic model, electron, proton, neutron, nucleus, atomic number, mass number, atomic mass, ion (cation and anion), element, atom, molecule, periodic table, group number, period number, metal, nonmetal, metalloid, valence electron (energy level), isotope, ball-and-stick

Safety Considerations

Please refer to the [Alabama State Department of Education Lab Safety Guidelines](#).

How can matter be described in terms of atoms and molecules, which are too small to be seen by the naked eye?

Background

Matter has mass and takes up space, which means it also has volume. Matter on the macroscopic level has specific characteristics, like color and texture. However, it is comprised of tiny particles that cannot be seen by the naked eye. These particles are defined as compounds, molecules, atoms, and subatomic particles. The characteristics of matter on the macroscopic level and on the particulate level are different. For example, the copper coating of a penny has an orange-brown coloring. However, copper atoms are not described in terms of color.

Activity and Consideration

Activity

Display several objects for student groups (represent solids with something like a hammer; represent liquids with something like water; represent gases with something like a balloon filled with air). Ask students to create a list of descriptions of each object. Show or draw a picture of each object at the atomic level so that students can visualize the difference between properties at the atomic level and at the macrolevel. An example is shown below.

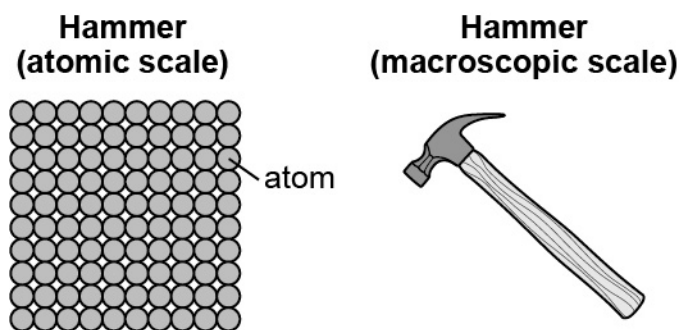

Note for the students that the hammer has unique physical characteristics (e.g., hard, solid) due to the way the atoms interact with each other. In solids, the atoms are very attracted to each other. Repeat the same procedure with the water and the air in the balloon. The atoms that comprise liquids are less attracted to each other and can move more freely than in solids. In a gas, the atoms have very little attraction to each other and are moving freely. These atomic characteristics are what give bulk matter its physical properties.

Consideration

A common misconception is that a solid (like the hammer) is made of atoms that are solid and that liquids (like water) are made of atoms that are liquid. Note that individual atoms or molecules are not assigned a state of matter. How atoms and molecules interact with each other is what defines how matter appears to the naked eye.

From a given model, how can atoms be represented in terms of subatomic particles?

How do atomic models of different elements compare to one another?

Background

Matter is comprised of atoms and atoms are comprised of subatomic particles. At this level, they can be defined as protons, neutrons and electrons. All atoms are structured the same way. The center of the atom is called the nucleus, and it contains the atom's protons and neutrons. The nucleus is very dense (almost all the atom's mass is contained here). Electrons are located outside the nucleus and are typically represented in rings or shells. Protons and neutrons have the same mass. Electrons are so small in comparison that they are considered to be massless. Models of different atoms will contain different numbers of protons, as that is what determines an atom's identity. The numbers of neutrons and electrons may differ from atom to atom. A model of an oxygen atom is shown below.

Bohr Model of an Oxygen Atom

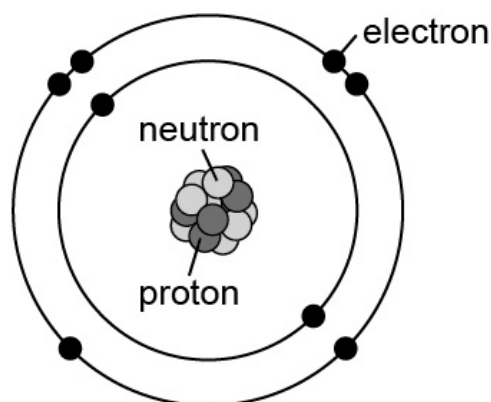

Activity and Considerations

Activity

Have students build models of atoms using the following computer simulation from PhET. This simulation allows students to manipulate the number of subatomic particles to change the type of atom or the nature of the atom. A link to the simulation is provided in the “Resources” section below.

Considerations

A common misconception is that atoms are solid because they are made of smaller particles. In fact, most of the atom is empty space. The nucleus of an atom (as represented in the model shown above) is often shown to be large. In fact, the nucleus is very dense. An analogy for the size comparison is that if an atom were the size of a football field, the nucleus would be in the center and would only be the size of a blueberry.

The exact location of electrons in an atom is beyond the scope of this grade level. However, it is helpful to explain that atomic models are not exact representations of real atoms. Electrons are not located in circular shells that orbit a nucleus (like a planet/Sun model), even though they are often represented that way in models. The electrons actually have predicted locations in three-dimensional shapes called orbitals. The quantum model of an atom is shown below.

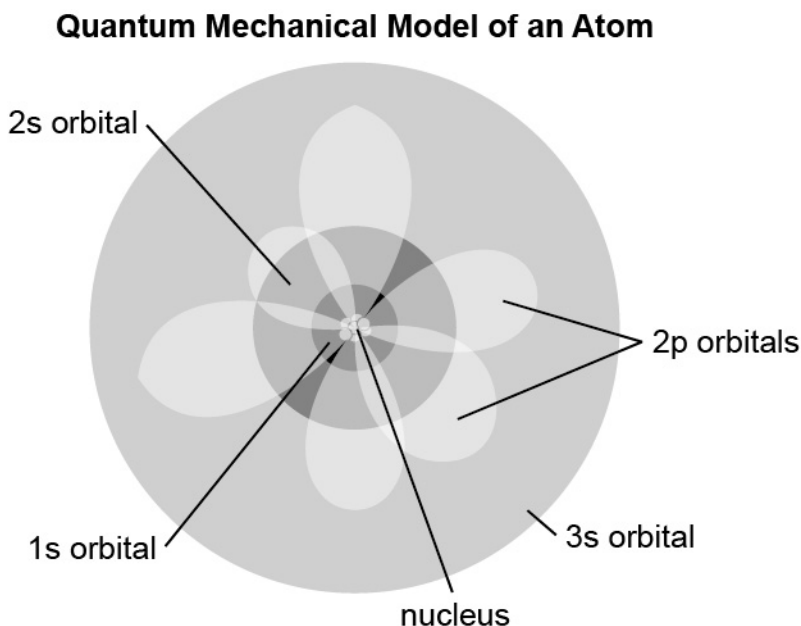

Resources

- [Activity Computer Simulation](#)—PhET interactive simulation
- [Prove Atoms Exist](#)—classroom science experiments that allow students to prove atoms exist from brighthubeducation.com

What are some limitations of molecular and atomic models?

Background

Models in science are often used to represent predictions, as is the case with atomic models. The model commonly used to represent atoms is called a Bohr model. It shows the nucleus at the center, with electrons orbiting in concentric rings. This model only held true for the hydrogen atom, but it is still used to describe the location of subatomic particles because it helps visualize the location of subatomic particles in relation to each other. A more accurate model of an atom is the quantum mechanical model. It is not often used to show subatomic particles because of its complexity. There are always trade-offs with models used in science. Some are more accurate than others but may be too complicated for understanding fundamentals.

Another limitation is modeling how atoms interact with each other. Molecules of water are often shown to have one oxygen atom connected to two hydrogen atoms as shown below.

Molecular Model of Water

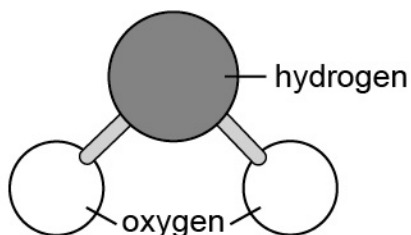

The limitation of this model is that it appears that there is a physical connecting piece (shown with the line) between the atoms. In fact, the atoms are “connected” through an electrostatic attraction. There is not a physical bond that tethers the atoms together.

How can the relationship between atomic number and the number of protons be described?

How does the number of protons and electrons in an atom determine the atom's characteristics?

How do different atoms of the same element compare in terms of mass, number of subatomic particles, ions, isotopes, and stability?

Background

The atomic number of an atom indicates the number of protons the atom has in its nucleus. This number is like a fingerprint; it is unique to each atom. Oxygen's atomic number is 8, which means that oxygen has 8 protons. No other atom will have 8 protons. If you know that an atom has 16 protons, then you can use the periodic table to determine that the atom is sulfur because sulfur's atomic number is 16. The atomic number will always be a whole number because there will not be a partial proton.

The number of protons in an atom will partially determine its mass, as the sum of protons and neutrons determines the mass of the atom. Because the mass of the electrons is so small compared to the mass of the protons and neutrons, the number of electrons is not factored into the atom's total mass, referred to as a mass number. The atomic number and mass number of an atom are often represented using the two formats shown below.

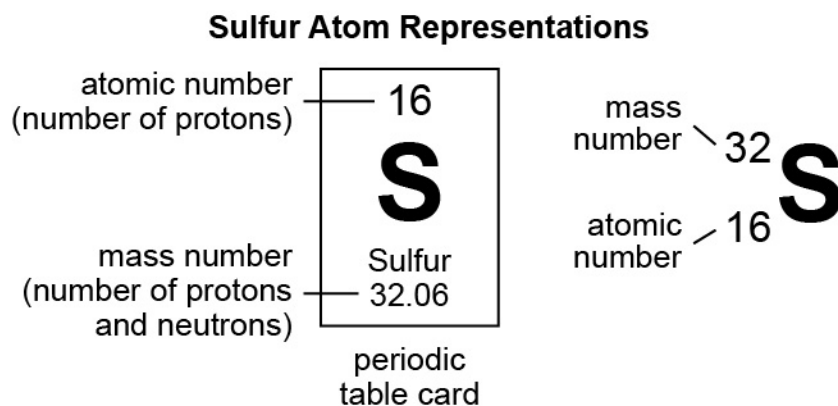

Recall that all sulfur atoms have the same number of protons, but they do not all have the same number of neutrons, which means that not all sulfur atoms have the same mass number. Variations within the same type of atom are called isotopes. Two isotopes of sulfur in isotopic notation are shown below.

Two Sulfur Isotopes

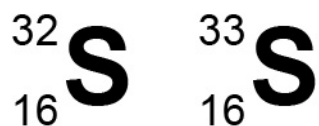

Protons have a positive charge, which gives the nucleus a positive charge. Electrons have a negative charge. Atoms are neutral, which means that the number of protons must equal the number of electrons in an atom. If an atom has an atomic number of 6, then the atom has 6 protons and 6 electrons. Since electrons are located outside the nucleus of the atom, they are the key players in chemical reactions. Electrons can be transferred between atoms. If an atom gains an electron, it becomes a negative ion. If an atom loses an electron, it becomes a positive ion. The addition or removal of electrons does not affect the atomic number or mass number. Models and notation examples are shown below.

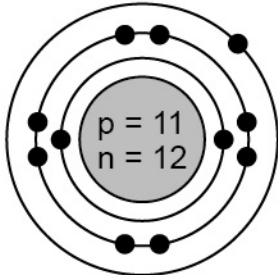
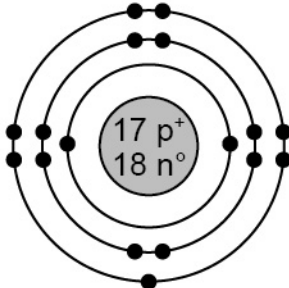
	Sodium (Na)	Chlorine (Cl)
Model		
Ion	Na ¹⁺ (sodium lost 1 electron)	Cl ¹⁻ (chlorine gained 1 electron)
Isotopes	${}^{23}_{11}\text{Na}$ ${}^{24}_{11}\text{Na}$	${}^{37}_{17}\text{Cl}$ ${}^{35}_{17}\text{Cl}$
Atomic Number	11	17
Mass Numbers	23 and 24	37 and 35

Activity and Consideration

Activity

A good method for students to demonstrate proficiency with these concepts is to fill out tables for neutral atoms, ions, and isotopes. Below are three examples to use.

Neutral Atoms

Symbol	Atomic Number	Mass Number	Protons	Neutrons	Electrons
C	6	12			
Mg				12	
H		1		0	

Ions

Symbol	Atomic Number	Mass Number	Protons	Neutrons	Electrons
O ²⁻	8		8	8	
K ¹⁺		39	19		
Al ³⁺	13	27			

Isotopes

Symbol	Atomic Number	Mass Number	Protons	Neutrons	Electrons
C		12			
C		14			

Consideration

Students may confuse mass number with the average atomic mass listed on the periodic table. Mass numbers will always be whole numbers because they are the sum of whole particles. Average atomic masses are weighted averages of all the variations (isotopes) of that atom.

How can the data represented on the periodic table be used to predict properties of atoms?

How is the periodic table arranged in terms of metallic character?

What happens to the number of subatomic particles as you go from left to right or top to bottom on the periodic table?

Background

The periodic table is based on the concept of periodicity. That is, the location of elements on the periodic table is based on trends in the atoms' characteristics. The element locations on the periodic table are based on atomic number, which increases by one proton from left to right across the table. From one period to the next (top to bottom), the number of protons, electrons, and neutrons increases substantially. As the number of protons increases, so does the number of electrons. Generally, neutrons also increase from left to right across the table, with a few exceptions. The number of valence electrons also exhibit a pattern on the periodic table, which will be discussed in the next section.

Another pattern that emerges on the periodic table is metallic character, which is largely based on bonding potential. Metals are located on the far left and middle of the periodic table. The nonmetals are located on the far right of the periodic table. Elements that are metals tend to exhibit characteristics such as malleability, ductility, conductivity, luster, and reactivity with acids. Nonmetals tend to be gases at room temperature. Elements that are found in the transition between metals and nonmetals are called metalloids. They share characteristics that describe both metals and nonmetals.

Periodic Table of Metallic Character Trend

	1 IA																18 VIIIA	
1	H	2 IIA											5 B	6 C	7 N	8 O	9 F	10 Ne
2	Li	Be											13 Al	14 Si	15 P	16 S	17 Cl	18 Ar
3	Na	Mg	3 IIIB	4 IVB	5 VB	6 VIB	7 VIIB	8 VIII B	9 VIII B	10 VIII B	11 IB	12 IIB	13 Al	14 Si	15 P	16 S	17 Cl	18 Ar
4	19 K	20 Ca	21 Sc	22 Ti	23 V	24 Cr	25 Mn	26 Fe	27 Co	28 Co	29 Cu	30 Zn	31 Ga	32 Ge	33 As	34 Se	35 Br	36 Kr
5	37 Rb	38 Sr	39 Y	40 Zr	41 Nb	42 Mo	43 Tc	44 Ru	45 Rh	46 Pd	47 Ag	48 Cd	49 In	50 Sn	51 Sb	52 Te	53 I	54 Xe
6	55 Cs	56 Ba	57 La	72 Hf	73 Ta	74 W	75 Re	76 Os	77 Ir	78 Pt	79 Au	80 Hg	81 Tl	82 Pb	83 Bi	84 Po	85 At	86 Rn
7	87 Fr	88 Ra	89 Ac															
				58 Ce	59 Pr	60 Nd	61 Pm	62 Sm	63 Eu	64 Gd	65 Tb	66 Dy	67 Ho	68 Er	69 Tm	70 Yb	71 Lu	
				90 Th	91 Pa	92 U	93 Np	94 Pu	95 Am	96 Cm	97 Bk	98 Cf	99 Es	100 Fm	101 Md	102 No	103 Lr	

Increasing Metallic Character

Activity and Consideration

Activity

Students can explore whether elements are metals, nonmetals, or metalloids based on their properties. Samples of elements such as carbon, silicon, sulfur, aluminum, and magnesium can be distributed to students. Students can tap the samples with a hammer. The samples of nonmetals such as carbon and sulfur are brittle and will crumble. The samples of metals are malleable and will not crumble. Students can use a conductivity meter to test the conductivity of each sample. Metals are great conductors of electricity, while nonmetals are nonconductors. Students can also place a small portion of each sample into a test tube with 1mL of 0.5 M HCl (hydrochloric acid). Metals such as magnesium and aluminum react with acid to produce hydrogen gas. Nonmetals do not react with HCl. Samples that are metalloids, such as silicon, will have characteristics that fall into both categories.

Consideration

There are elements that do not fit into the general trend of characteristics. For example, mercury is a metal, but it is a liquid at room temperature. Sulfur, a nonmetal, is a solid at room temperature.

What is the relationship between the number of valence electrons and the types of bonds formed between atoms?

How can the periodic table be used to describe why some atoms form bonds by transferring electrons but other atoms form bonds by sharing them?

Which characteristics of a molecule can be demonstrated by a ball-and-stick model?

Background

Valence electrons are electrons that are located on the outermost portion of the atom and participate in bonding. The illustration below shows a model of an atom, noting the valence electrons in boxes.

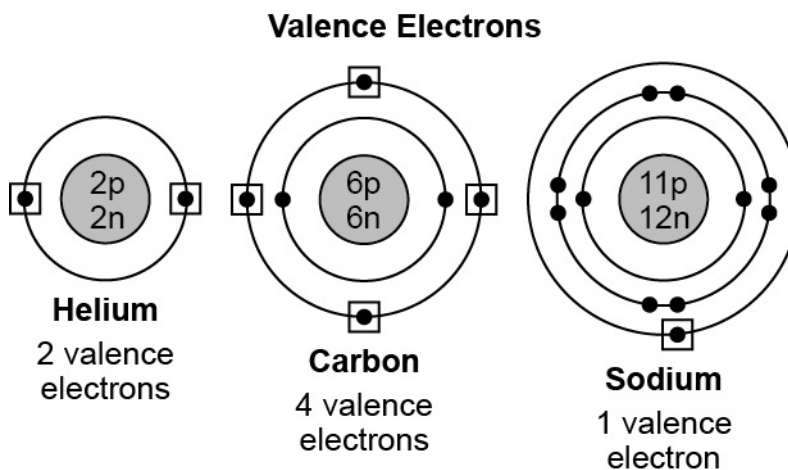

The number of valence electrons an atom has increases from left to right across the periodic table. Group 1 atoms have 1 valence electron, group 2 atoms have 2 valence electrons, etc. The period table shown below highlights this pattern for the main group elements.

Valence Electrons in Each Group

1																				2
1	2														3	4	5	6	7	8
1	2														3	4	5	6	7	8
1	2														3	4	5	6	7	8
1	2														3	4	5	6	7	8
1	2														3	4	5	6		
1	2														3	4	5	6		

The number of valence electrons plays a role in an atom's stability, what type of bonds that atom will form, and how many bonds it will form. Atoms are most stable with a full shell of valence electrons, which is either 2 or 8. Sodium, for example has 1 valence electron. If sodium were to lose that 1 valence electron, a full shell of 8 valence electrons remains, forming the Na^{+1} ion.

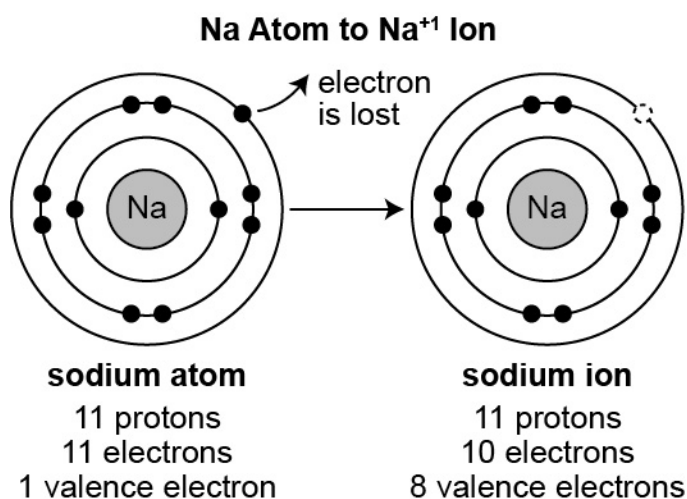

Atoms that form positive ions, such as metals, form ionic bonds with atoms that form negative ions, such as nonmetals. Ionic bonds result when atoms transfer valence electrons. Sodium, for example, transfers its 1 valence electron to chlorine, which has 7 valence electrons, forming sodium chloride.

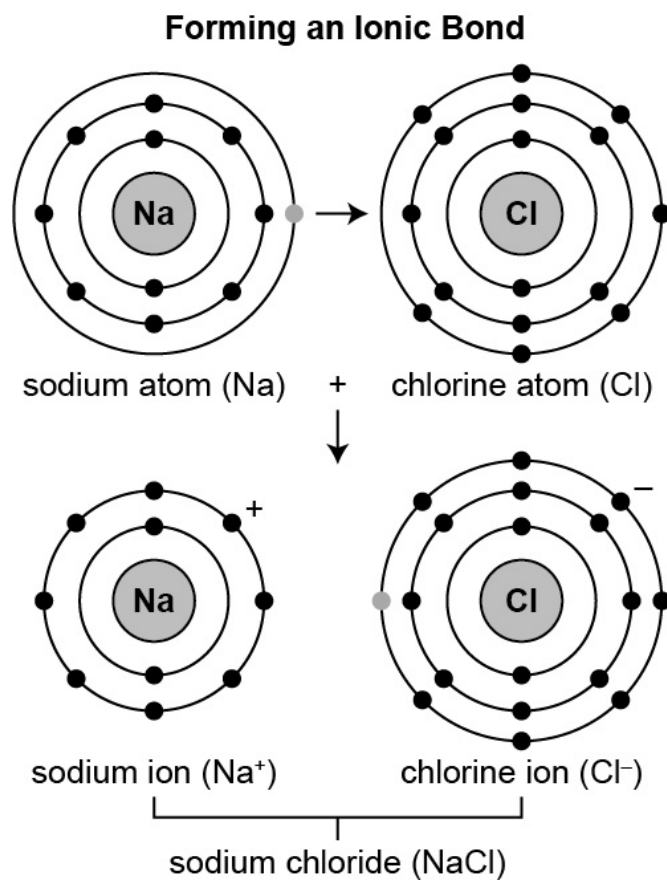

Atoms can also share, rather than transfer, valence electrons. Covalent bonds form as a result of atoms sharing valence electrons. Nonmetals often bond with one another in this way. Carbon, for example, has 4 valence electrons. A carbon atom can share those four valence electrons with hydrogen atoms.

Sharing Valence Electrons

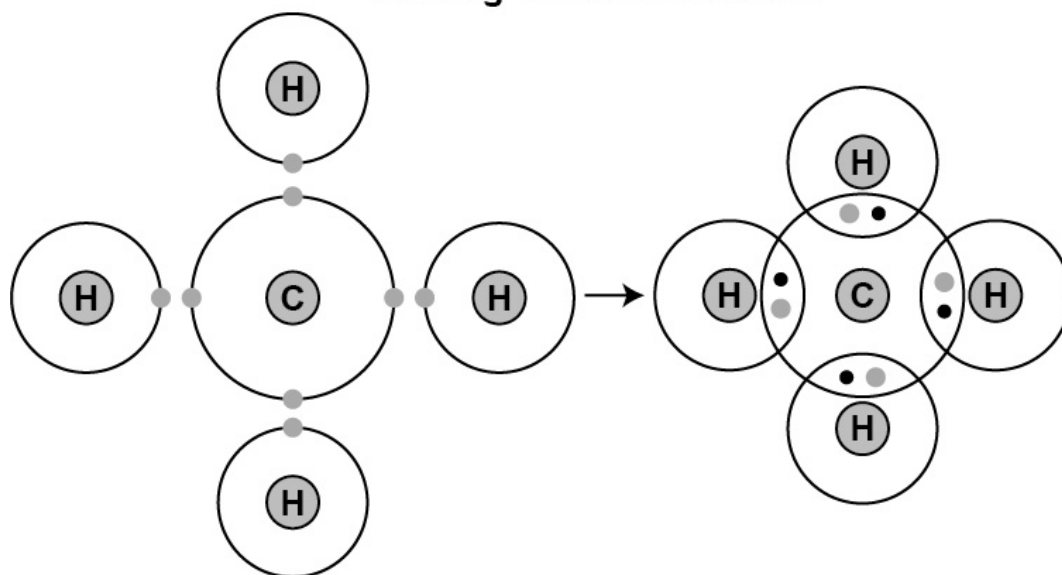

Covalent molecules, formed when valence electrons are shared, are often modeled using ball-and-stick diagrams. Spheres represent the atoms and lines represent the bond formed between two atoms. Each line represents two valence electrons. A ball-and-stick model for CH_4 is shown below.

Ball-and-Stick Model for CH_4

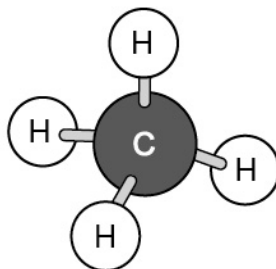

Activity and Consideration

Activity

Students can either access this bonding simulation independently or the simulation can be done as a demonstration. In the simulation, students experience both ionic and covalent bonding and the relationship between those bonds and the periodic table. Students can visualize how electrons are transferred and shared, forming ionic and covalent bonds. A link to the simulation is provided in the “Resources” section below.

Consideration

A common misconception among students is that bonds are a physical tethering of atoms. This misconception is propagated when models like the ball-and-stick model are used. Remind students that bonds, whether ionic or covalent, are electrostatic interactions and not a physical connecting entity that forms.

Resources

- [Activity Simulation](#)—teachchemistry.org
- [Prove Atoms Exist](#)—classroom science experiments that allow students to prove atoms exist from brighthubeducation.com
- [The Periodic Table](#)—basic overview of the periodic table of elements from Bitesize
- [Build an Atom](#)—interactive simulation for students to learn about the components of atoms from PhET

Grade 8
Matter and Its Interactions
8.PS.2 Plan and carry out investigations to generate evidence supporting the claim that one pure substance can be distinguished from another based on characteristic properties.

Connections to *A Framework for K–12 Science Education: Practices, Crosscutting Concepts, and Core Ideas:*

Focus for Scientific and Engineering Practice(s):

- Planning and Carrying Out Investigations
- Analyzing and Interpreting Data
- Developing and Using Models

Focus for Crosscutting Concept(s):

- Patterns
- Structure and Function

Focus for Disciplinary Core Idea(s):

- Structure and Properties of Matter
- Chemical Reactions

Key Academic Terms:

chemical property, physical property, density, investigation, pure substance, texture, color, luster, odor, melting point, boiling point, solubility, mass, shape, reactivity, conductivity, malleability, ductility, mixture, volume, metal, nonmetal, semiconductor, metalloid

Safety Considerations

Please refer to the [Alabama State Department of Education Lab Safety Guidelines](#).

What are the similarities and differences between pure substances and mixtures?

How could models be used to represent the difference between a pure substance and a mixture?

Background

Compounds, molecules, and atoms are all pure substances. When more than one pure substance is combined, a mixture is formed. The table below shows molecular models of pure substances and mixtures.

Pure Substance vs. Mixture

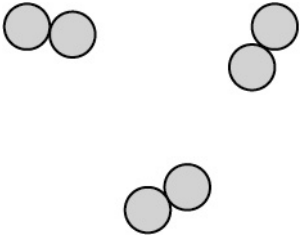
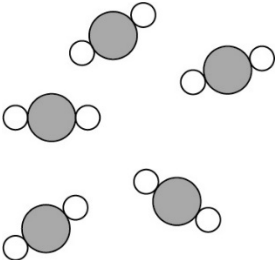
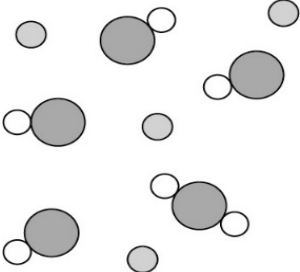
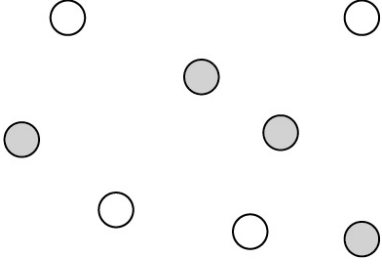
	Example 1	Example 2
Pure substance		
Mixture		

A key difference between a pure substance and a mixture is how they can be separated. In order for a pure substance like a compound to be separated, a chemical change must occur. For instance, sodium chloride can be separated into sodium and chlorine in a chemical reaction. The result of the reaction is that two new substances are produced.

Decomposition of Sodium Chloride

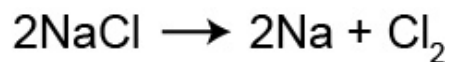

A mixture can be separated through physical means. For example, a mixture of water and salt can be separated by boiling the mixture. The liquid water will turn into a gas, leaving behind the salt. After the separation, the resulting components are still the same (salt and water).

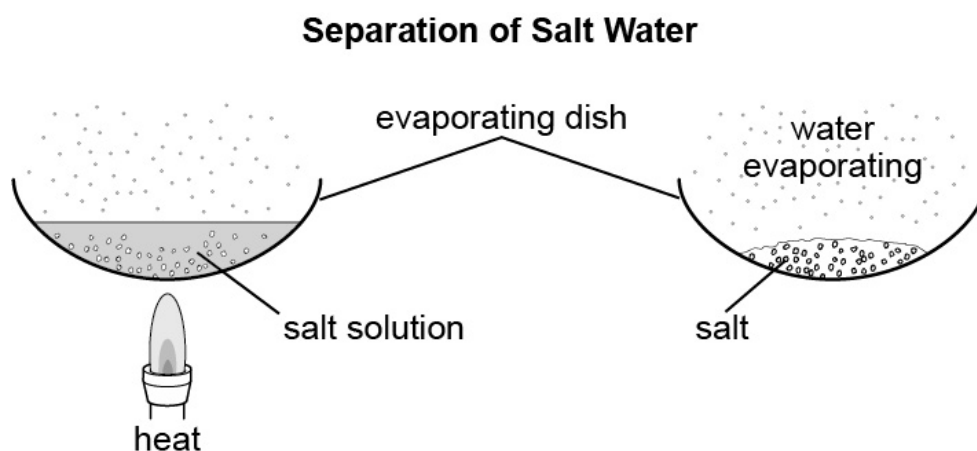

Activity and Consideration

Activity

Show students the models in the list shown below. Ask the students to label each model as either a mixture or a pure substance. Ask students whether a chemical or physical technique is needed to separate each substance.

Student Activity for Mixtures and Pure Substances

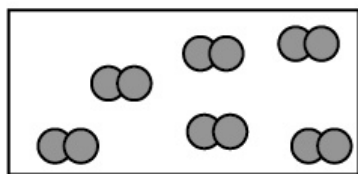

A

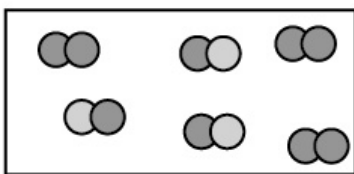

B

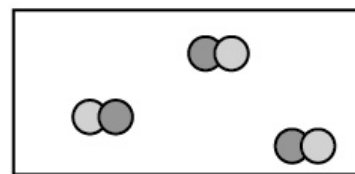

C

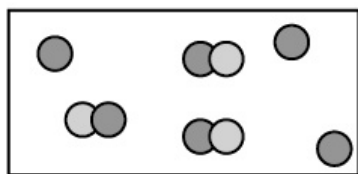

D

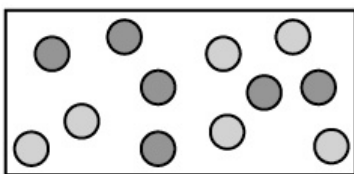

E

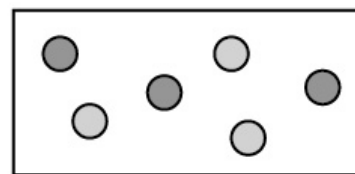

F

Key:

A: pure substance (chemical), B: mixture (physical), C: pure substance (chemical), D: mixture (physical), E: mixture (physical), F: mixture (physical)

Consideration

What do pure substances and mixtures have in common? They are all forms of matter. Matter is anything that has a mass and volume. Matter is described in one of two ways—either it exists as a pure substance or as a mixture. Sometimes, it is easy to determine whether a sample of matter is a mixture by simply viewing it. Sand mixed with water, for example, will often separate into layers. Some mixtures, like solutions, are difficult to observe as mixtures directly.

How are physical and chemical properties of pure substances different?

How do the properties of matter, both physical and chemical, dictate its function?

From a given investigation plan, how can students differentiate between pure substances based on their physical and chemical properties?

Background

Pure substances have unique physical properties. Physical properties can be tested without changing the chemical nature of the matter being examined. Examples of physical properties are listed below.

boiling point: the temperature at which a pure substance changes from a liquid to a gas at a given pressure

melting point: the temperature at which a pure substance changes from a solid to a liquid

malleability: a material's ability to be shaped and formed

ductility: a material's ability to be formed into a wire

density: the amount of matter in a given space (mass/volume)

solubility: a material's ability to dissolve

hardness: a mineral's resistance to scratching

color: the hue of a material as seen by the human eye

odor: the smell of a material

luster: the interaction of light with a material

electrical conductivity: a material's ability to conduct electricity

state of matter: a substance's state at a given temperature (i.e., solid, liquid, gas, or plasma)

thermal conductivity: a material's ability to transfer thermal energy (heat)

Pure substances have unique chemical properties. Chemical properties cannot be tested without changing the chemical nature of the matter being examined. Examples of chemical properties are included below.

reactivity: the degree to which a material chemically reacts with other substances, such as acids, copper (II) chloride, and air

flammability: how readily a substance combusts, which is related to reactivity with oxygen

heat of combustion: the difference in energy between reactants and products in a combustion reaction

Both chemical and physical properties dictate the function of a substance. For example, water has a boiling point at standard pressure of 100°C, which means that water in most places on Earth exists as a liquid. Ionic compounds like NaCl have very high boiling points, so they are most likely to be found as solids. Copper has high electrical conductivity, so it is often a component in wiring. Some substances have low flammability as one of their chemical properties, so they are used to make bedding and insulation.

Activity

An investigation was conducted to determine the boiling points of three substances as shown in the table.

Substance	Boiling Point (in °C at standard pressure)	Observations at Room Temperature
Sodium chloride (NaCl)	1,413	Solid white crystals
Oxygen (O ₂)	-183	Colorless gas
Water (H ₂ O)	100	Colorless liquid

Given the information from the investigation, have students work in groups to correct each false statement.

1. Sodium chloride (NaCl) is a pure substance because it has a high boiling point.

Correction: Sodium chloride (NaCl) is a pure substance because it has one specific boiling point (at standard pressure).

2. Oxygen (O₂) is a mixture because it is made from more than one atom.

Correction: Oxygen (O₂) is a pure substance because it is made from one type of atom.

3. Salt water (NaCl_(aq)) is a pure substance because it looks uniform throughout.

Correction: Salt water (NaCl_(aq)) is a mixture because it contains more than one type of pure substance, NaCl and H₂O.

4. Salt water (NaCl_(aq)) would have a boiling point that is equal to the sum of the boiling points of sodium chloride and water.

Correction: Salt water (NaCl_(aq)) would have a variable boiling point, depending on the ratio of salt and water. Mixtures do not have specific boiling points.

What type of data would need to be collected to determine the density of a pure substance?

How can the density of an object be investigated and analyzed using common substances, like water?

Background

Density is a physical property of a pure substance, which means that it can be determined without changing the chemical makeup of the substance being tested. Density is defined as the amount of matter in a given volume. Mathematically, the formula for calculating density is the following:

$$\text{Density} = \frac{\text{mass}}{\text{volume}}$$

The units for density values depend on the units attached to both the mass and volume measurements. Some common units for density are grams per milliliter (g/mL) and kilograms per cubic centimeter (kg/cm³).

Pure substances have unique densities and, as such, can be used to differentiate one pure substance from another. A list of densities for some common substances is shown in the table below.

Densities of Four Pure Substances

Substance	Density at Room Temperature (g/cm³)
Helium (He)	0.000179
Sucrose (C ₁₂ H ₂₂ O ₁₁)	1.59
Carbon dioxide (CO ₂)	0.00196
Water (H ₂ O)	1.00

Activities and Consideration

Activity 1

Students can determine the density of both a cube and an irregularly shaped object.

To determine the density of a cube, students will need to use a balance or an electronic scale in order to determine the cube's mass.

Sample mass: 1.59 g

Students will then use a ruler to measure the length, width, and height of the cube. The measurements can be used to calculate the volume of the cube.

Sample measurements:

Length: 1.00 cm

Width: 1.00 cm

Height: 1.00 cm

Volume = $l \times w \times h$

= 1 cm³

$$\begin{aligned}\text{Density} &= \frac{\text{mass}}{\text{volume}} \\ &= 1.59 \text{ g}/1.00 \text{ cm}^3 \\ &= 1.59 \text{ g}/\text{cm}^3\end{aligned}$$

The students can use the table of densities provided above to determine what the cube is made from (sucrose).

To determine the density of an irregularly shaped object, students will need to use a balance or an electronic scale to determine the object's mass.

Sample mass: 5.16 g

Students will use water displacement to calculate the volume of the irregularly shaped object. Students should add 20 mL of water to a 50-mL graduated cylinder. Then, students should add the irregularly shaped object to the cylinder and record the new volume.

Sample measurements:

Initial volume of water: 20.0 mL

Final volume of water: 22.0 mL

Volume of irregularly shaped object = 2.0 mL

$$\begin{aligned}\text{Density} &= \frac{\text{mass}}{\text{volume}} \\ &= 5.16 \text{ g}/2.0 \text{ mL} \\ &= 2.58 \text{ g}/\text{mL}\end{aligned}$$

The students can use the table of densities provided above to determine what the irregularly shaped object is made from. They will see that there are no densities listed in the table that match that of the irregularly shaped object. Therefore, they can determine that the irregularly shaped object is not made from sucrose, helium, carbon dioxide, or water.

Activity 2

Students can determine relative densities of objects in comparison to water, which has a density of 1.00 g/mL. If an object floats in water, it is less dense than water. If the object sinks in water, the object is denser than water. Students can build a density column, starting with the densest liquid first and slowly layering the liquids. The resulting column demonstrates the relative densities of common liquids.

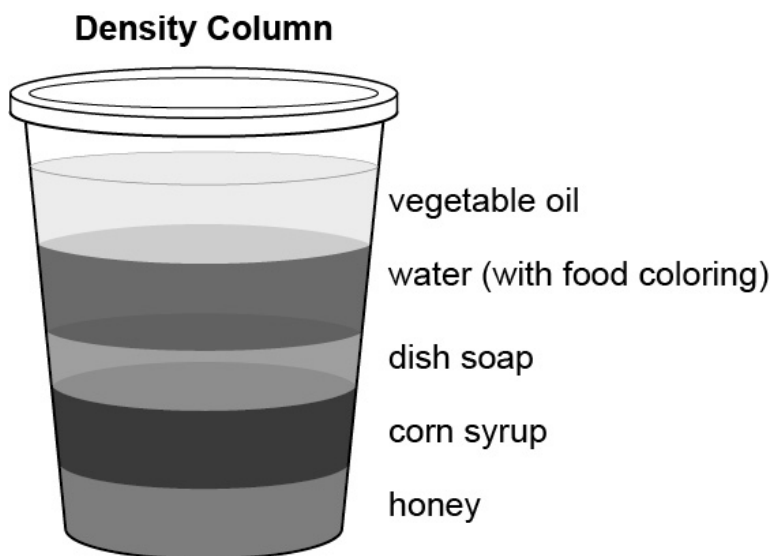

Consideration

The density of a pure substance can change depending on the state of matter. Gases occupy more space than solids do, which means they have larger volumes. When volume increases, the density of the substance decreases.

The densities of nitrogen in different states are listed below as an example.

Solid nitrogen = 1.03 g/cm^3

Liquid nitrogen = 0.81 g/cm^3

Gaseous nitrogen = 0.0013 g/cm^3

Resource

- [The Engineering ToolBox](#)—Website that lists the density of common solids.

What evidence, in terms of properties, can be used to differentiate metals from nonmetals?

Background

Generally, metals and nonmetals have different physical properties, as listed in the table.

Physical Properties of Metals and Nonmetals

Metals	Nonmetals
Malleable	Brittle
High melting points	Low melting points
Solid at room temperature	Gas at room temperature
High boiling points	Low boiling points
Shiny	Dull
Good conductors of electricity and heat	Poor conductors of electricity and heat
High densities	Low densities

Activity and Consideration

Activity

Students can test unknown samples to determine whether they are most likely metals or nonmetals. There are a variety of tools that can be used, depending on what the teacher has available. Some possible samples are listed below.

- Carbon
- Sulfur
- Aluminum
- Copper
- Zinc
- Magnesium

Students can take samples of each element and test the following characteristics:

1. Students can test electrical conductivity by placing a handheld conductivity meter on the sample. The metals will be better conductors of electricity than the nonmetals.

2. Students can test brittleness by gently tapping the samples with a hammer. The nonmetals will break more easily than the metals.
3. Students can test luster by observing the surface of the sample. The metals will appear shinier than the nonmetals.

Students can also use a sample of silicon, which is a metalloid. They will observe that it is shiny, brittle, a weak conductor, and a solid at room temperature. Elements that have properties like those of both metals and nonmetals are called metalloids. Some metalloids are used as semiconductors in electronics.

Consideration

Some elements do not follow the typical patterns. Mercury, a metal, is a liquid at room temperature. Some metals like aluminum and beryllium have low densities. Sulfur and carbon, both nonmetals, are solid at room temperature. Bromine, also a nonmetal, is a liquid at room temperature.

Resource

- [Metals and Nonmetals](#)—selection of articles about the differences between metals and nonmetals from acs.org

What is the relationship between a claim, evidence, and data?

Background

Often, the process of science starts with a question. In order to answer the question, scientists make a claim. A claim is a simple statement that attempts to partially answer the question being asked. Scientific investigations follow and attempt to verify or disprove the claim. Those investigations produce data and evidence. Evidence, in the form of data and observations, allows scientists to provide reasoning about the claim.

Grade 8
Matter and Its Interactions
8.PS.3 Construct explanations based on evidence from investigations to differentiate among compounds, mixtures, and solutions. a. Collect and analyze information to illustrate how synthetic materials (e.g., medicine, food additives, alternative fuels, plastics) are derived from natural resources and how they impact society.

Connections to *A Framework for K–12 Science Education: Practices, Crosscutting Concepts, and Core Ideas:*

Focus for Scientific and Engineering Practice(s):

- Constructing Explanations and Designing Solutions
- Developing and Using Models
- Analyzing and Interpreting Data
- Obtaining, Evaluating, and Communicating Information

Focus for Crosscutting Concept(s):

- Structure and Function
- Patterns

Focus for Disciplinary Core Idea(s):

- Structure and Properties of Matter

Key Academic Terms:

mixture, pure substance, atom, solution, compound, solute, solvent, molecule, suspension, heterogeneous, homogeneous, natural resource, plastic, synthetic, unsaturated, saturated, supersaturated

Safety Considerations

Please refer to the [Alabama State Department of Education Lab Safety Guidelines](#).

What is the difference between an atom, a molecule, and a compound?

How are the components of a compound held together?

Background

An atom is often described as the simplest form of matter, in that all matter is made from atoms. When atoms combine in whole number ratios, molecules and compounds form. Compounds are made from different types of atoms that are chemically combined. The atoms that form a compound are combined with bonds that are either covalent or ionic in nature. A molecule is associated with compounds that are molecular or are made from atoms that form covalent bonds. Ionic compounds, like salt, are not molecular, meaning they do not exist as discrete molecules. However, atoms of the same element that are bonded to each other are also considered molecules. The table below shows examples of atoms, compounds, and molecules.

Atoms, Compounds, and Molecules

Example	Atom	Compound	Molecule
Na	Yes	No	No
CO ₂	No	Yes	Yes
MgCl ₂	No	Yes	No
H ₂	No	No	Yes
O ₃	No	No	Yes
He	Yes	No	No

Activity and Considerations

Activity

Students can practice identifying atoms, compounds, and molecules by completing the practice table below.

Atoms, Compounds, and Molecules

Example	Type of Bonding	Atom	Compound	Molecule
C ₂ H ₆	covalent			
Cl ₂	covalent			
HCl	covalent			
Al ₂ O ₃	ionic			
K				

Atoms, Compounds, and Molecules: Key

Example	Type of Bonding	Atom	Compound	Molecule
C ₂ H ₆	covalent	No	Yes	Yes
Cl ₂	covalent	No	No	Yes
HCl	covalent	No	Yes	Yes
Al ₂ O ₃	ionic	No	Yes	No
K	none	Yes	No	No

Considerations

Students often struggle with molecules like N_2 , I_2 , O_3 , etc. The molecules are not considered compounds because the atoms are of the same type. They are not atoms either because there is more than 1 unit within the molecule. It may help students when they identify atoms, molecules, and compounds to give them the type of bond.

Another difficult item for students to conceptualize is a discrete molecule compared to the lattice structure of a salt. Students may need to be reminded that there is not one molecule of NaCl. The atoms Na and Cl combine chemically in repeating units called lattice structures. However, covalently bonded molecules such as H_2O exist in discrete units.

Lattice Structure vs. Discrete Molecule

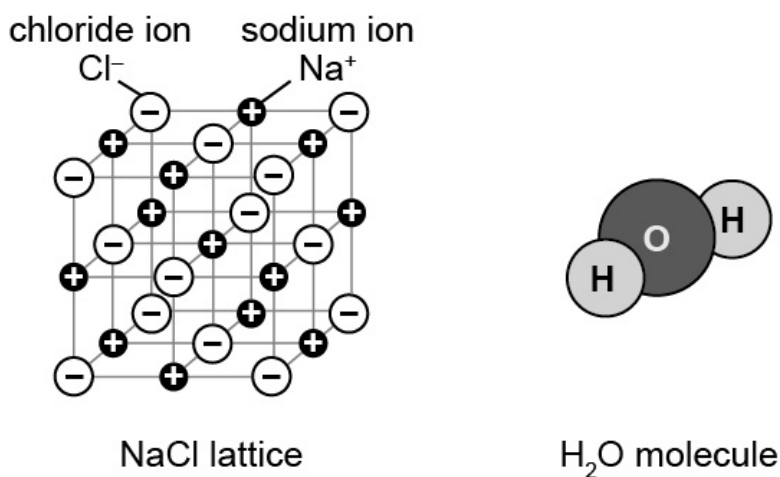

How are molecular models used to differentiate between pure substances and mixtures?

Background

Compounds, molecules, and atoms are all pure substances. When more than one pure substance is combined, a mixture is formed. The table below shows molecular models of pure substances and mixtures.

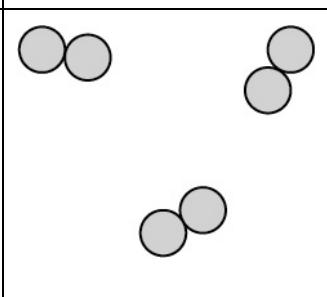
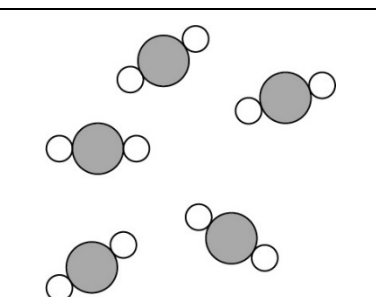
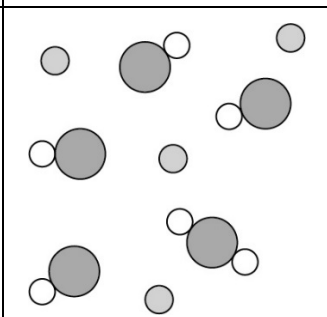
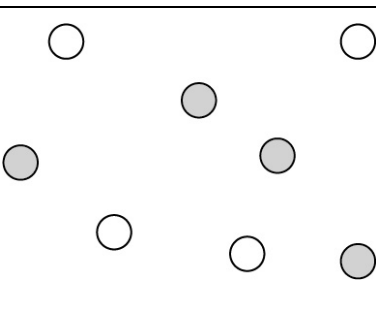
Pure Substance vs. Mixture		
	Example 1	Example 2
Pure Substance		
Mixture		

Activity

Students can practice identifying the examples shown below as mixtures or pure substances. Students can then describe each model using terms such as atom, element, molecule, and compound.

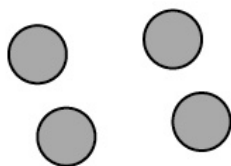
Example A

pure substance or mixture

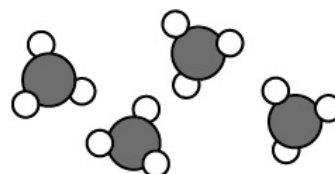
Example B

pure substance or mixture

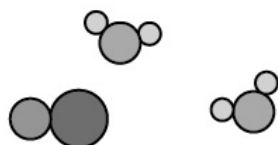
Example C

pure substance or mixture

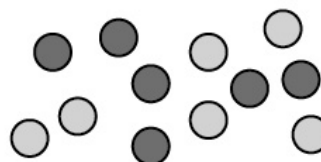
Example D

pure substance or mixture

Key:

Example A: pure substance; element (one type of atom)

Example B: pure substance; one type of molecule

Example C: mixture made from two different molecules

Example D: mixture of two different elements

How would models serve to construct explanations that differentiate homogeneous and heterogeneous mixtures?

How would models of aqueous salt solutions compare to models of aqueous sugar solutions?

Background

Matter is classified as either a pure substance or a mixture. However, there are two ways in which mixtures are classified: homogenous and heterogenous. Homogenous mixtures are described as being uniform. This means that homogenous mixtures are not obviously made of more than one different particle type. Homogenous mixtures are called solutions, which are made from a solvent and solute. The best example of a solution is salt water. The salt is dissolved in the water, so salt is the solute and water is the solvent. The resulting solution looks just like water, a pure substance, to the naked eye. Sugar water is another example of a

solution. Sugar (the solute) dissolves in water (the solvent). Recall that salt is a compound but not a molecule, whereas sugar is a compound and a molecule. The resulting molecular models of salt water and sugar water solutions look different.

Salt Dissolving in Water—Creating a Salt Solution

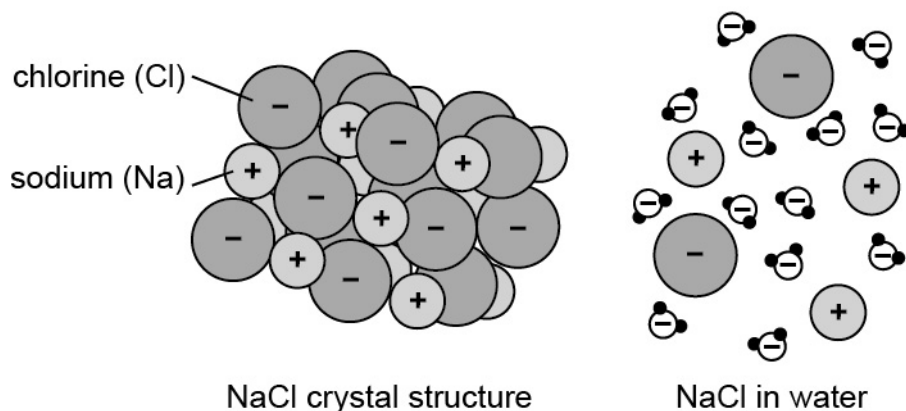

Sugar Dissolving in Water—Creating a Sugar Water Solution

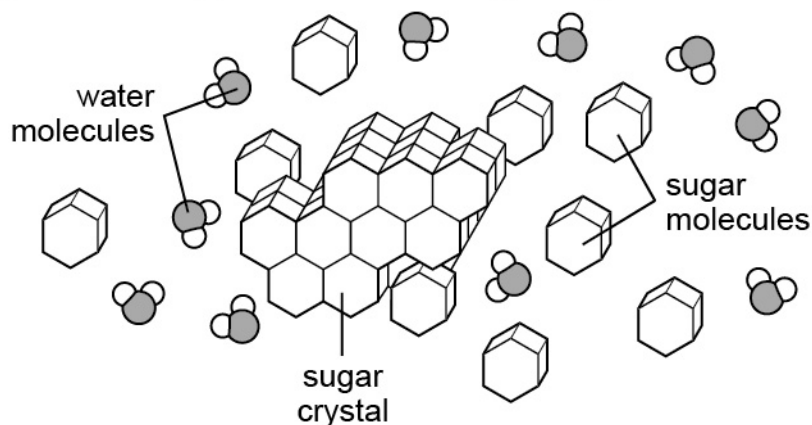

Notice in the models shown above that the salt lattice breaks apart into ions (charged particles). However, sugar separates into individual sugar molecules. The sugar molecule is still intact; it is only separated from other sugar molecules. Both models represent homogenous mixtures, called solutions, but depending on which type of bonding is present, the molecular models vary.

The other common type of mixture is a heterogeneous mixture called a suspension. These types of mixtures have particles that will eventually settle out over time, creating an appearance that does not look uniform. Examples of suspensions are orange juice with pulp, salad dressing, and sand. Suspensions can be separated by filtration or manual separation.

Molecular Model of a Suspension

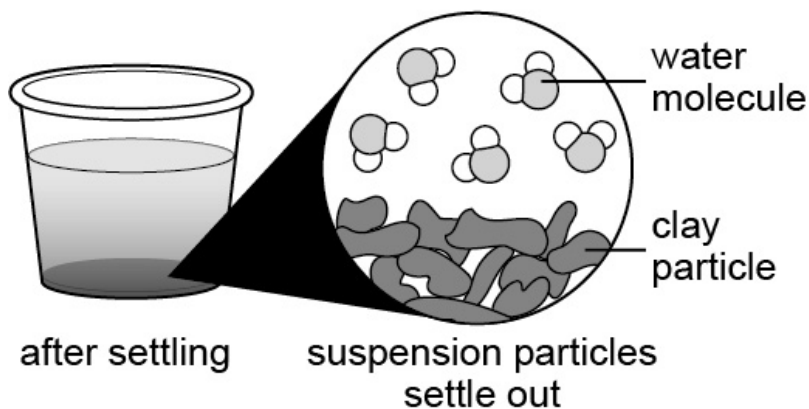

A flow chart of how matter is classified is shown below. Recall that homogenous mixtures are called solutions. They appear uniform throughout. Heterogenous solutions are often called suspensions and do not appear uniform.

Pure Substances vs. Mixtures

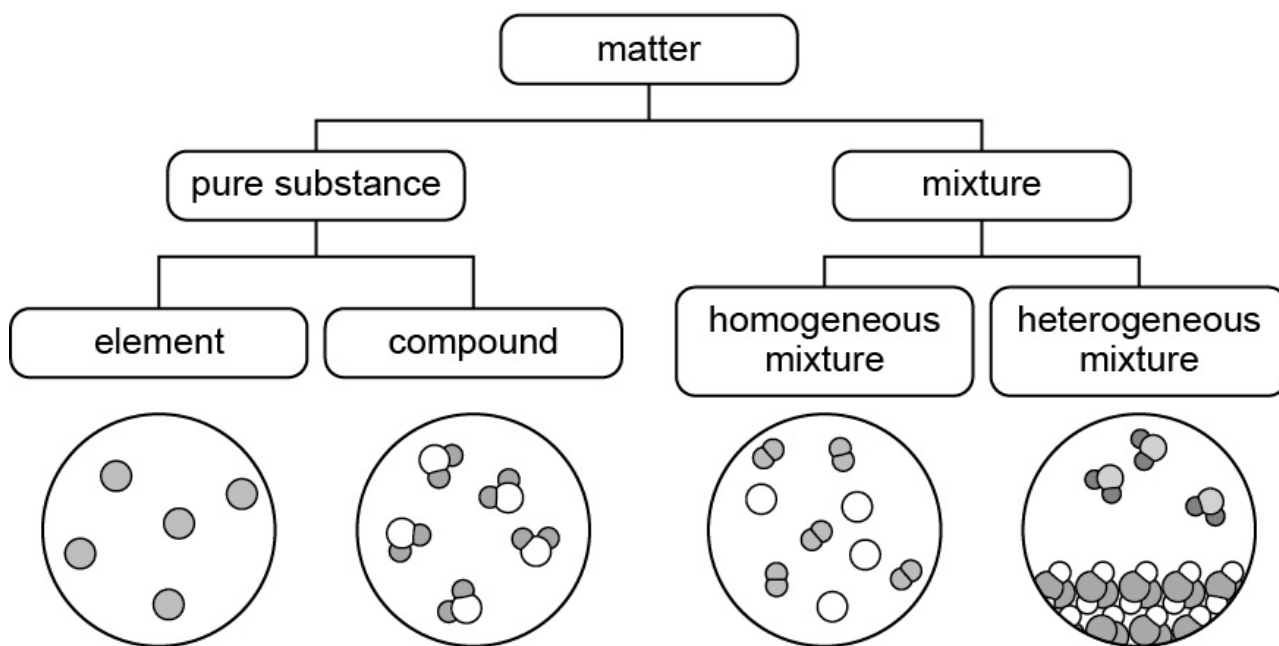

Activity and Consideration

Activity

Have students label the following models to indicate whether a mixture or pure substance is shown and, if a mixture is shown, what type of mixture it is.

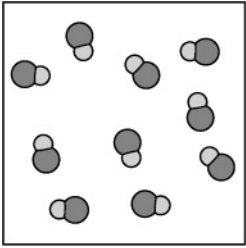
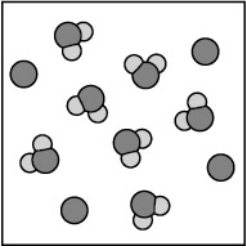
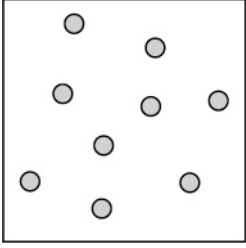
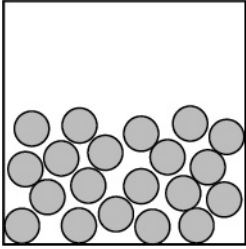
Molecular Model	Pure Substance	Mixture (Homogenous)	Mixture (Heterogenous)
			
			
			
			

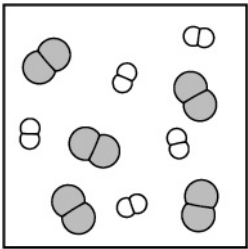
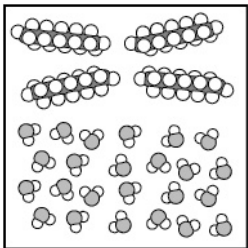
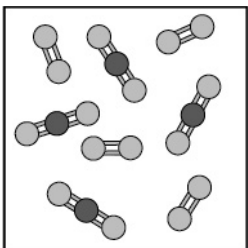
Key:

Top Down: pure substance, homogenous mixture, pure substance, pure substance, homogenous mixture, heterogenous mixture, homogenous mixture

Consideration

Some students will think that all liquids are solutions and that all solutions are liquids. Remind them that a true liquid is a pure substance, like water or liquid bromine. Gas mixtures can be considered solutions. One example is air, wherein nitrogen is the solvent and oxygen, carbon dioxide, and argon are the solutes. Brass and other alloys are also solutions but are solid at room temperature. Ask students to explain why air could also be considered a suspension. When you look at smaller samples of air, it is uniform throughout. However, as one flies into a city with smog, it is evident that the heavier particles have settled, and a layer is evident.

How do unsaturated, saturated, and supersaturated solutions compare to one another?

Background

A saturated solution contains the maximum amount of solute dissolved for a given volume of solvent at a given temperature. If more solute is added to a saturated solution without a change in temperature, the solute will remain undissolved. An unsaturated solution can dissolve more solute. If more solute is added to an unsaturated solution, the solute will dissolve until the solution becomes saturated. Supersaturated solutions are created when a saturated solution is cooled slowly, keeping more solute dissolved at a given temperature than is stable. If the solution is disrupted (adding solute, shaking, tapping, etc.), the solute will crystallize out of the solution. Students can test solutions to determine whether they are unsaturated or saturated by adding a crystal to each solution.

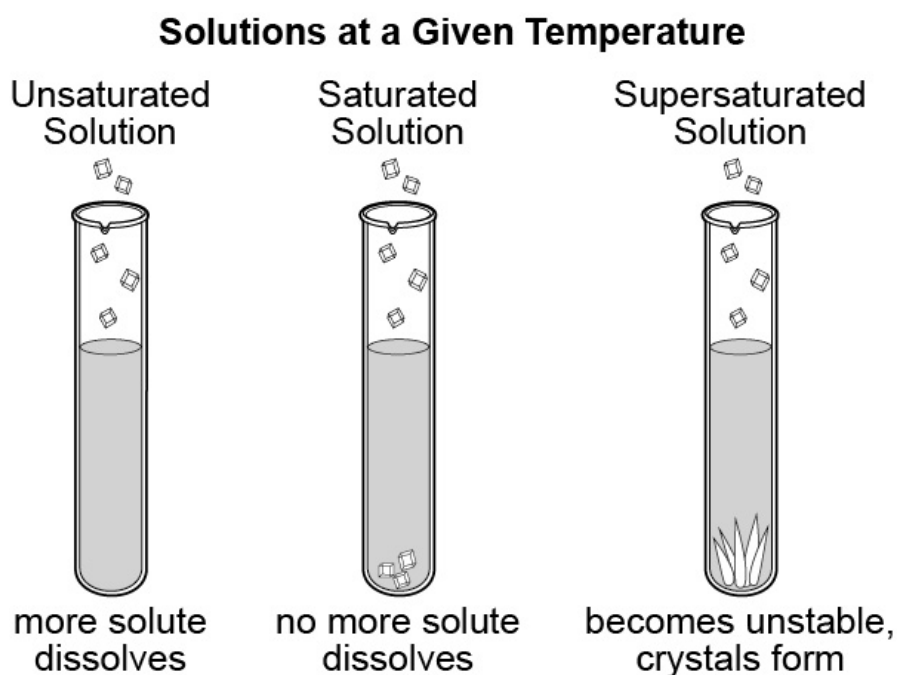

Activity and Consideration

Activity

Students can consult a solubility curve for pure substances dissolved in water.

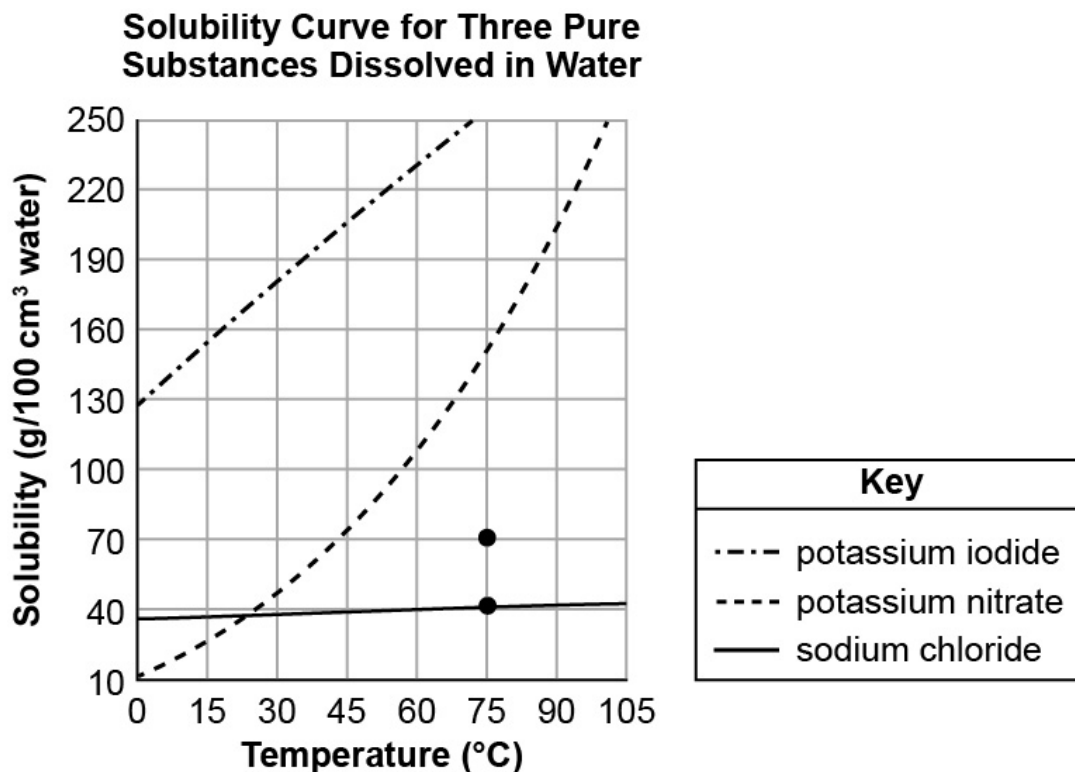

Students should notice that as the temperature increases, more solute can dissolve in 100 mL of water. Using the curve, students can see that if 40 grams of sodium chloride is added to 100 mL of water at 75°C, the solution is saturated (on the line). If more than 70 grams of sodium chloride is added to the same solution, the solution is still saturated, but 30 grams of sodium chloride will remain undissolved.

Consideration

Most ionic compounds that are soluble in water dissolve endothermically, meaning that as the temperature increases, more solute can dissolve. Some ionic compounds dissolve exothermically, meaning that as the temperature increases, less solute can dissolve. This is also true of gases.

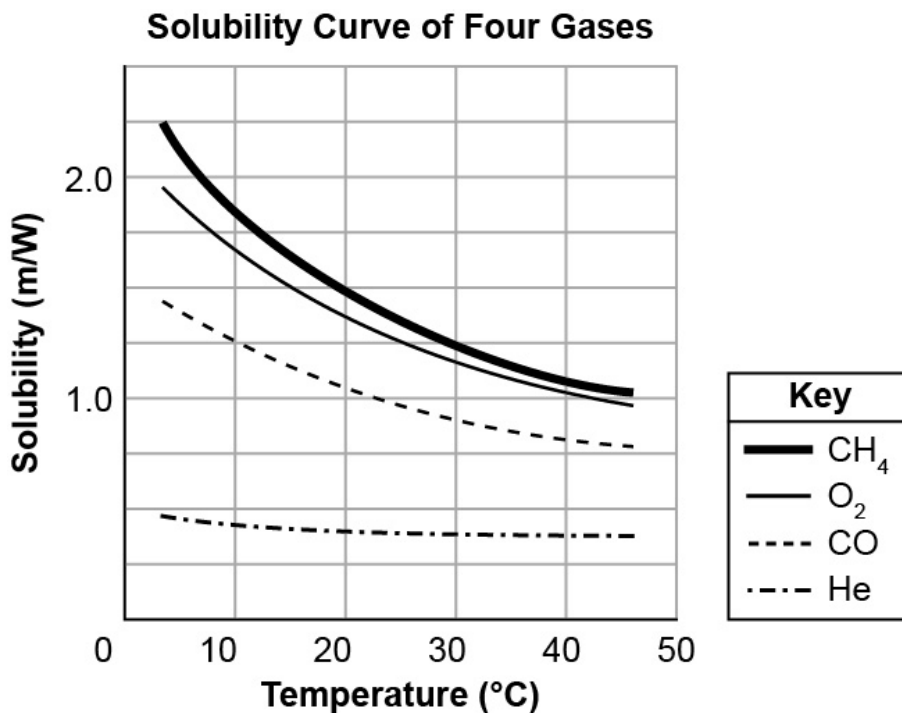

What evidence could be generated that would explain the difference between mixtures and pure substances?

What investigative steps would generate evidence that a substance is either a mixture or a pure substance?

Background

The simplest method of investigating a sample to determine whether it is a mixture or a pure substance is determining what is required for it to be separated. A pure substance cannot be separated by physical means, while mixtures can be. Physical separation techniques include but are not limited to manual separation, boiling, melting, and filtering.

Activity and Consideration

Activity

This activity can be done as a demonstration or in small groups, depending on the equipment available in the classroom. To prepare the activity, combine coffee grounds, oil, water, salt, and sand in a large container and mix well. After a few minutes, the mixture in the container will settle into layers (oil will be on the top and the sand and coffee grounds will be on the bottom). Ask students how to describe the contents in the container. Some answers may include: there are layers, it doesn't look uniform, it is a mixture, it is a suspension. Ask students to brainstorm

how to separate the heterogenous mixture. What would be the easiest way to remove one component? Demonstrate “skimming” the oil layer from the top of the mixture with a spoon. Next, demonstrate filtering the mixture for the class by pouring the contents through a strainer with small openings. The sand and most of the coffee grounds will stay in the strainer, while the salty water will flow through. Rinsing the sand and coffee grounds may be needed to remove some of the salt water clinging to the large particles. The salt water solution that remains is a homogenous mixture. Boiling the solution will vaporize the water, leaving solid salt behind.

Consideration

Experimental evidence can be used to determine whether a substance is a pure substance or a mixture. If a substance contains more than one type of compound, for example, there will be more than boiling point. Distillation is often used to demonstrate separating mixtures based on boiling points. The opposite is true for pure substances. Pure oxygen gas (at STP), for instance, has one boiling point, one density, one state of matter, etc.

How does the use of synthetic materials affect society?

Background

A synthetic substance is something that changes into a new substance through a chemical reaction. Nylon and plastics are synthetic materials that are formed from petroleum, which is a natural material. Wood, wool, silk, and cotton are additional examples of natural materials. Often, scientists will synthesize a compound that is already found in nature, such as caffeine. Caffeine is a naturally occurring compound found in cocoa and coffee beans; however, the caffeine found in some sodas is synthetic. Synthetic materials, such as polyester, can be manufactured quickly and in large volumes, resulting in lower-priced items. There are advantages and disadvantages of both natural and synthetic materials, as shown the tables below.

Advantages & Disadvantages: Synthetics

Advantages	Disadvantages
Long lasting	Not biodegradable
Inexpensive to produce	Oil is a finite resource
Flexible uses	Require chemical reactions to produce

Advantages & Disadvantages: Natural

Advantages	Disadvantages
May be biodegradable	Can be expensive to produce
May come from renewable resources (trees)	Are not tailor-made to needs

Resource

- [Natural Resources and Synthetic Materials](#)—lesson plan designed to engage students in identifying and describing synthetic materials from ACS (middleschoolchemistry.org)

Grade 8
Matter and Its Interactions
8.PS.4 Design and conduct an experiment to determine changes in particle motion, temperature, and state of a pure substance when thermal energy is added to or removed from a system.

Connections to *A Framework for K–12 Science Education: Practices, Crosscutting Concepts, and Core Ideas:*

Focus for Scientific and Engineering Practice(s):

- Planning and Carrying Out Investigations
- Developing and Using Models
- Analyzing and Interpreting Data

Focus for Crosscutting Concept(s):

- Cause and Effect
- Patterns
- Energy and Matter

Focus for Disciplinary Core Idea(s):

- Structure and Properties of Matter
- Definitions of Energy

Key Academic Terms:

state of matter, solid, liquid, gas, heating curve, phase change (melting, vaporization, condensation, freezing, sublimation, deposition) thermal energy, kinetic energy, potential energy, pressure, molecular motion (particle motion), particle arrangement, temperature, heat (scientific definition), system, surrounding

Safety Considerations

Please refer to the [Alabama State Department of Education Lab Safety Guidelines](#).

How can gases, liquids, and solids be compared in terms of attractive forces?

How do models depicting the spatial arrangement of particles differ for the three basic states of matter?

Background

The attractive forces between particles in a substance largely determine that substance's state of matter. Attractive forces between particles are called intermolecular forces. Solids exist when particles have high intermolecular forces, while gases are defined as having no attractive forces. This means that in a gas, particles are not drawn to one another and only interact when colliding. The difference in spatial arrangement between solid, liquids, and gases is due to the differences of attraction between particles.

Activities

Activity 1

Have students predict what models of a solid, a liquid, and a gas would look like. Remind them that solids have the most attractive forces between particles and gases have the least.

State of Matter Models Answer Key

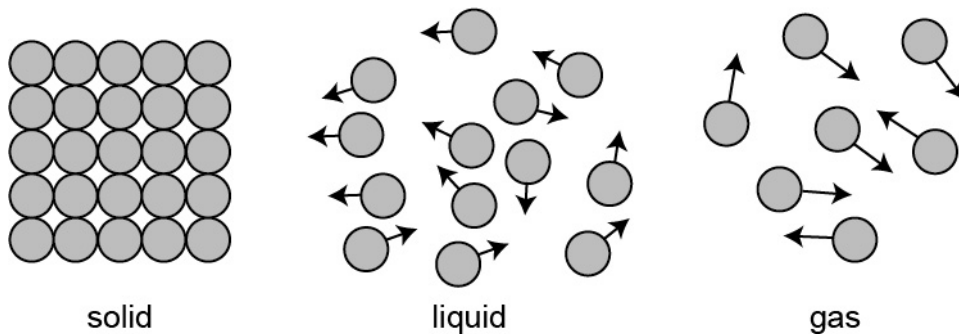

Activity 2

Pose a question to the class: why does a balloon expand when you blow air into it? Ask students to work in small groups to answer the question using their knowledge of the attractive forces between particles.

The goal of this exercise is to have students recognize that air is a gas. Gas particles have no intermolecular forces, so they move away from one another, causing the sides of the container to expand outward.

Ask students how the balloon would look different if the air inside the balloon changed into a solid. Students should recognize that the balloon would decrease in size (volume decreases) because the air particles would move closer together.

Activity 3

Which model best represents a balloon filled with gas?

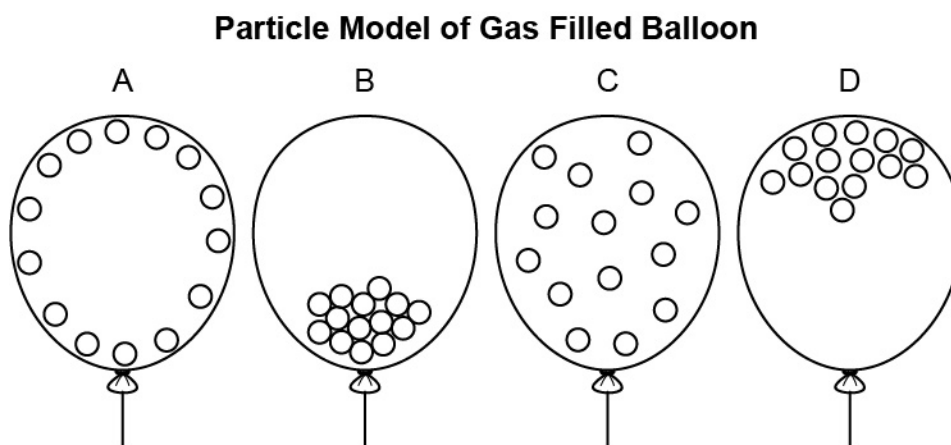

The correct answer is C. Many students will choose A because they confuse the lack of attraction between gas particles with repulsion. Gas particles are neither attracted to nor repelled from one another.

What is the relationship between the motion of molecules in a system and the kinetic energy of the particles in that system?

Background

Kinetic energy is the energy of motion. The faster particles move, the more kinetic energy a system has. The mathematical definition of kinetic energy is shown below.

$$\mathbf{KE = mv^2}$$

$$\mathbf{Kinetic\ energy = mass \times (velocity)^2}$$

In a sample of helium (He) atoms in a gaseous state, all the atoms have the same mass because they are all helium. However, not all the atoms are moving with the same velocity. That means that each individual helium atom does not have the same kinetic energy. When all the individual kinetic energies of the atoms are averaged, that number is referred to as the temperature of the system.

Activity

Ask the students the following questions:

1. Gas sample *A* has a mass of 32.00 grams. Gas sample *B* has a mass of 28.00 grams. If the two gas samples are both at 25°C, which sample has the greatest average kinetic energy?

Answer: Since both gas samples are at the same temperature, then both gas samples have the same average kinetic energy, regardless of their masses.

2. Based on the formula for kinetic energy, if mass is constant, what happens to kinetic energy if velocity doubles?

Answer: According to the formula, if velocity doubles, then kinetic energy quadruples (if mass is constant).

3. Gas sample *A* has a temperature of 25°C, and gas sample *B* has a temperature of 50°C. Which sample has particles that are, on average, moving the fastest?

Answer: Gas sample *B* has the higher temperature, so, on average, the particles are moving the fastest.

What is the relationship between the kinetic energy of gases, liquids, and solids?

What is the relationship between the potential energy of gases, liquids, and solids?

What is the relationship between thermal energy, kinetic energy, and temperature?

What tools are needed to observe or measure the amount of thermal energy in a substance over time?

Background

Energy is the ability to do work. There are several forms of energy, such as kinetic, thermal, and potential. Thermal energy is the energy produced by heat. Although heat and thermal energy are related, they are often confused. A substance, such as a water molecule, contains thermal energy. However, that same water molecule cannot contain heat, as heat is the transfer of energy from one object to another.



The kinetic energy of a substance increases as it changes from a solid to a liquid to a gas. Solids have the highest attractive forces and the lowest kinetic energy. Gases, conversely, have no significant attractive forces and have the most kinetic energy.

Potential energy is often referred to as the energy of position. In terms of molecules, potential energy is the energy stored in bonds. Solids have more attractive forces, so they have more stored energy. Gases, conversely, have no significant attractive forces and have the least stored energy.

Thermal energy, kinetic energy, and potential energy are found in related amounts. The sum of the kinetic energy and potential energy of an object is equal to the thermal energy of that object. The most straightforward way to measure thermal energy is to use a thermometer. Thermometers are filled with a substance like alcohol that expands or contracts depending on temperature. When the liquid inside the thermometer warms, it expands and rises up the column.

The table below shows a comparison of potential and kinetic energy levels across different states of matter.

Potential and Kinetic Energy Comparison

	Solid	Liquid	Gas
Kinetic energy (energy of motion)	increasing 		
Potential energy (stored energy)	increasing 		

Consideration

Students may simplify kinetic energy of states of matter by assuming that all gases have higher kinetic energy than all solids. However, the oxygen gas and liquid water in the classroom have the same average kinetic energy because both substances are at the same temperature. It is better to qualify that gases have the most kinetic energy and solids have the least when comparing the same substance (water vapor has more kinetic energy than ice). Students may also confuse gravitational potential energy with the potential energy stored in bonds. Remind students that the potential energy in gases is not determined by their position relative to one another. Rather, gases store less energy than solids due to their significantly low attractive forces.

How can students recognize, describe, and model changes in the energy of a pure substance as it is heated or cooled?

How can students recognize, describe, and model changes in the energy of a pure substance as it undergoes a phase change?

How can a change in the kinetic energy of particles be produced?

How can an investigation be designed to produce data that can be used to create a heating curve for a pure substance?

Background

As a solid is warmed, thermal energy is transferred from one object to another in the form of heat. An example of this would be holding an ice cube in your hand. In this case, the ice cube is considered the system and your hand is considered the surroundings. Energy is transferred from your hand to the ice cube (from surroundings to system, from higher temperature to lower temperature). As energy is added to the water molecules, the average kinetic energy (temperature) of the molecules increases. This increase in energy allows the molecules to begin to overcome the forces of attraction, allowing some separation and increased movement.

Molecular Model of a Solid Before and After Heating

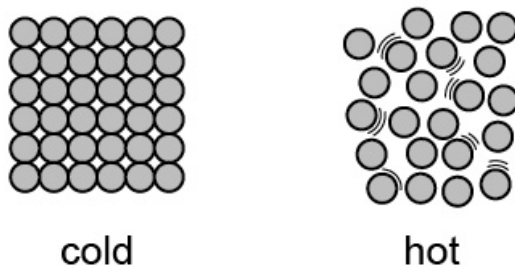

After a substance is heated or cooled enough, it will undergo a phase change, or a change from one state of matter to another. If water in the solid state is warmed enough, it will eventually liquify. Phase changes that substances undergo include the following:

- Melting (solid \rightarrow liquid)
- Freezing (liquid \rightarrow solid)
- Vaporization (liquid \rightarrow gas)

- Condensation (gas \rightarrow liquid)
- Deposition (gas \rightarrow solid)
- Sublimation (solid \rightarrow gas)

During a phase change, the temperature of the substance is constant. The change in energy is due to the change in potential energy of the system, not a change in the kinetic energy of the system. Heating curves are used to model the transfer of energy as a substance is heated from a solid to a gas.

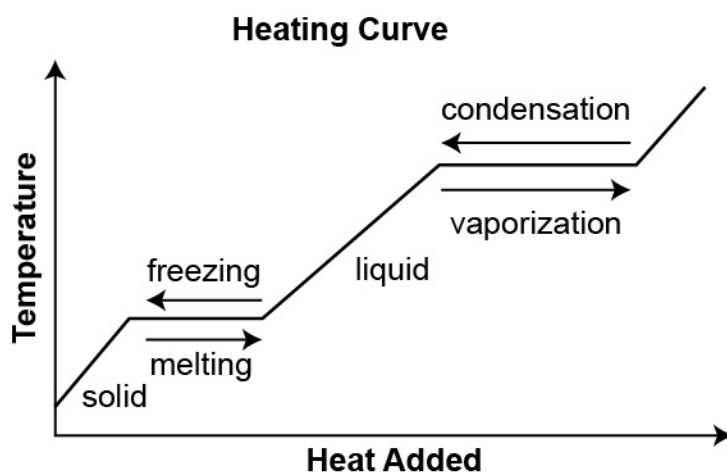

Notice that during a phase change, the line plateaus, representing a constant temperature.

Activities and Consideration

Activity 1

Students can match molecular models to the heating curve to represent the molecular arrangement and motion as substances are heated from a solid to a gas.

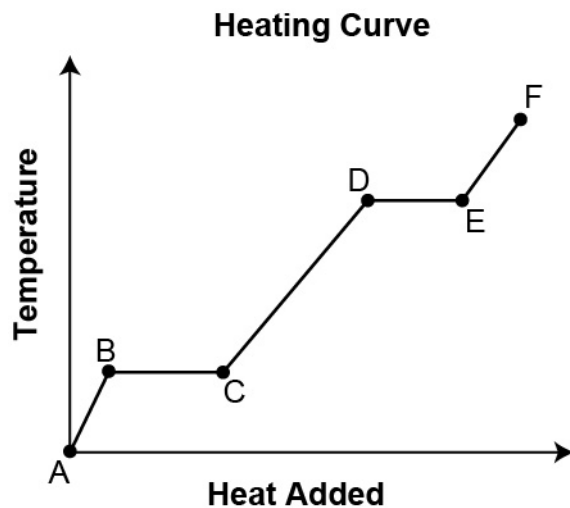

Place the letters from the heating curve next to the correct molecular models.

KEY:

Line A → B: Molecular model of a solid

Line B → C: Molecular models of solids and liquids

Line C → D: Molecular model of a liquid

Line D → E: Molecular models of liquids and gases

Line E → F: Molecular model of a gas

Activity 2

Students can generate a heating curve for water experimentally. Either as a demonstration or in small groups, set up an apparatus as shown:

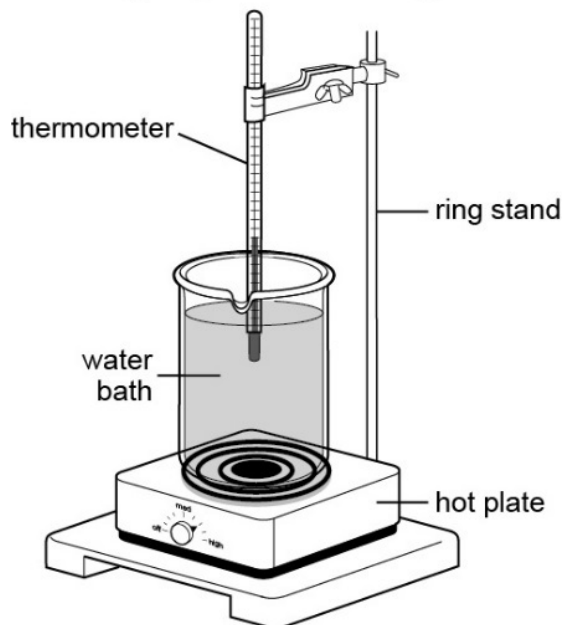
Investigating Water's Heating Curve

Add several ice cubes to the beaker and record the temperature of the ice and the initial time of 0 seconds. Slowly heat the ice in the beaker over medium/high heat. Record the temperature of the water every 30 seconds until the water comes to a boil. Use the data to create a heating curve.

Consideration

The heating curve that is generated experimentally will often not appear as students expect. One reason for that is that it is difficult to add heat to the system at a constant rate. Students should also understand that the heating curve is for pure substances, so distilled water is a better option to use in the investigation than tap water.

What is the relationship between changes in the pressure of a system and changes in the states of materials in the system?

Background

Due to the spatial arrangement of gas particles, gases respond to changes in pressure more than solids do. An increase in pressure removes some of the space between gas particles, forcing them closer together. In this way, gases can change to liquids with increasing pressure.

Increasing the Pressure on Gas Particles

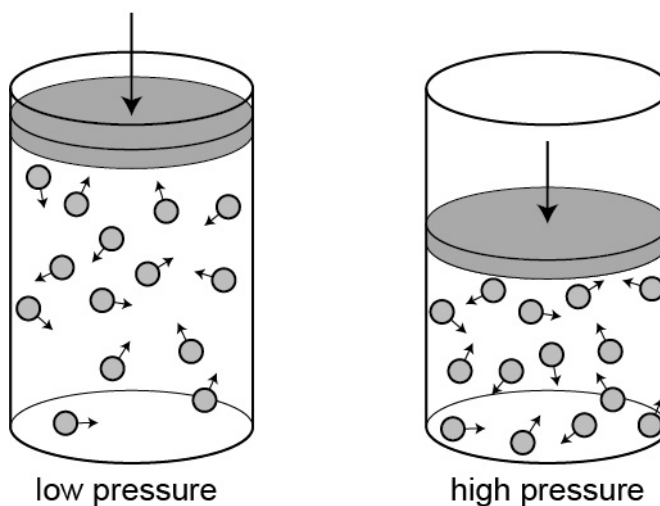

Activity and Consideration

Activity

This activity can be done as a demonstration, in small groups, or as a question posed to the class (depending on access to equipment). The activity needs three syringes. One syringe is filled with chalk powder (which is a solid), one is filled with liquid water, and the last one is filled with air. All three syringes are capped at the end. The plungers are then pushed down to investigate the compressibility of solids, liquids, and gases.

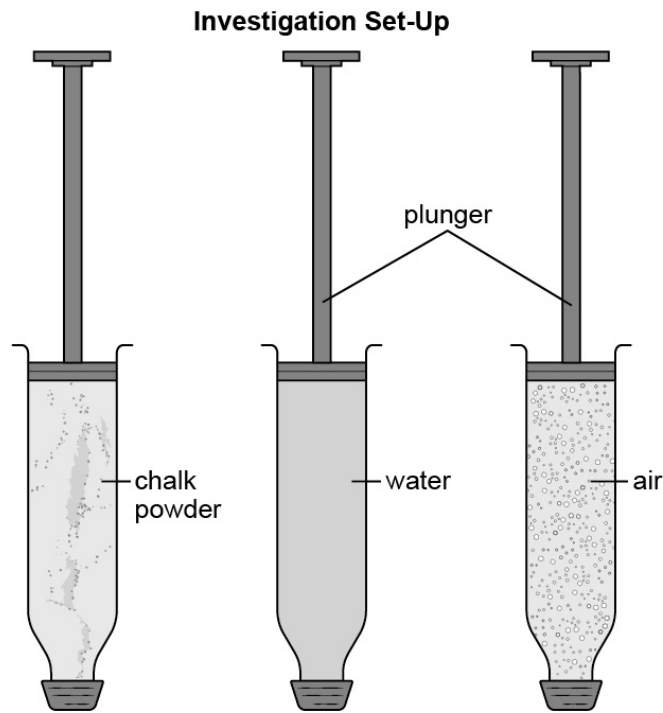

The students will see the following results:

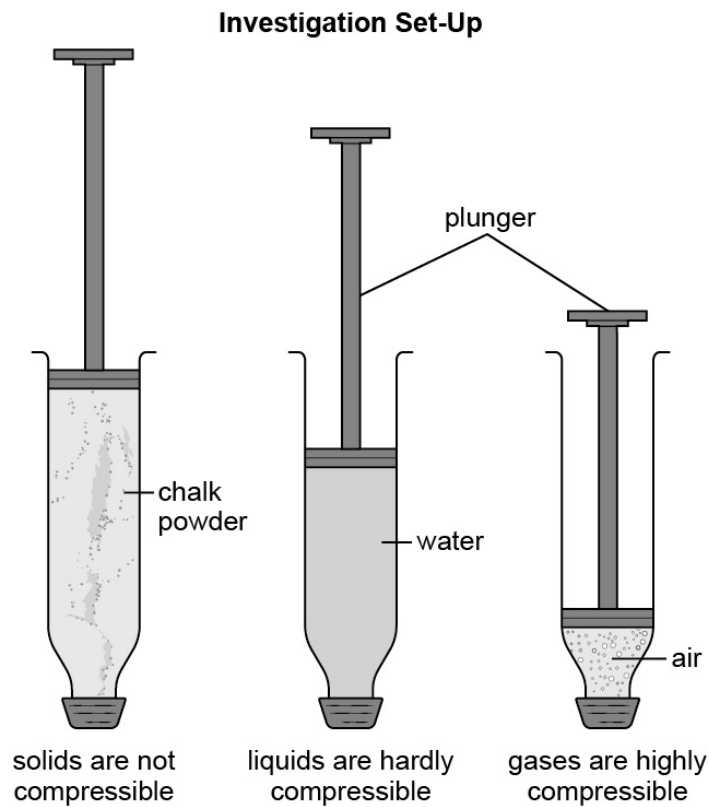

Consideration

Students should be able to connect the compressibility of solids, liquids, and gases to the spatial arrangement of particles in the three states of matter. Temperature plays a role with gas pressure as well. When a gas is heated, the kinetic energy of the particles increases. If the container is flexible (balloon, syringe, etc.) the volume of the container will increase, maintaining a constant pressure. If the container cannot change in size, pressure will increase.

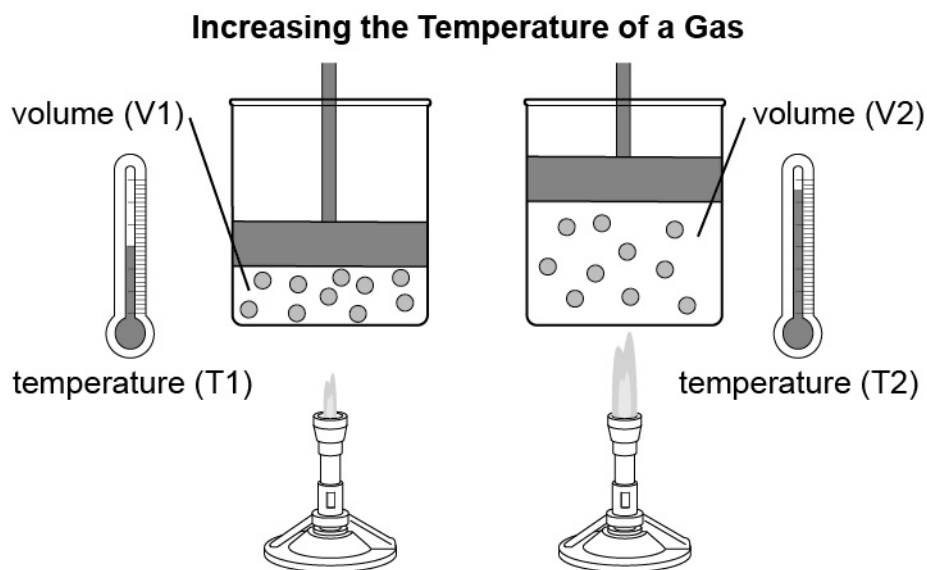

Resource

- [States of Matter](#)—simulation and discussion questions from PhET

Grade 8
Matter and Its Interactions
8.PS.5 Observe and analyze characteristic properties of substances (e.g., odor, density, solubility, flammability, melting point, boiling point) before and after the substances combine to determine if a chemical reaction has occurred.

Connections to *A Framework for K–12 Science Education: Practices, Crosscutting Concepts, and Core Ideas:*

Focus for Scientific and Engineering Practice(s):

- Analyzing and Interpreting Data
- Engaging in Arguments from Evidence

Focus for Crosscutting Concept(s):

- Patterns
- Cause and Effect

Focus for Disciplinary Core Idea(s):

- Structure and Properties of Matter
- Chemical Reactions
- Matter and Its Interactions

Key Academic Terms:

physical change, chemical change (chemical reaction), melting point, boiling point, freezing point, physical property, chemical property, reactant, product, density, solubility, flammability, odor, waft, observation

Safety Considerations

Please refer to the [Alabama State Department of Education Lab Safety Guidelines](#).

What are some common physical properties of pure substances?

Background

Pure substances have unique physical properties. Physical properties can be tested without changing the chemical nature of the matter being examined. Examples of physical properties are included below.

boiling point: the temperature at which a pure substance changes from a liquid to a gas at a given pressure

melting point: the temperature at which a pure substance changes from a solid to a liquid at a given pressure

malleability: a material's ability to be shaped and formed

ductility: a material's ability to be formed into a wire

density: the amount of matter in a given space (mass/volume)

solubility: a material's ability to dissolve

hardness: a mineral's resistance to scratching

color: the hue of a material as seen by the human eye

odor: the smell of a material

luster: the interaction of light with a material

electrical conductivity: a material's ability to conduct electricity

state of matter: a substance's state at a given temperature (i.e., solid, liquid, gas, or plasma)

thermal conductivity: a material's ability to transfer thermal energy (heat)

Activities and Considerations

Activity 1

Brainstorm physical properties of a piece of bread. Students could separate into lab groups (each with a piece of bread) or this could be done as a teacher demonstration. Do not allow the students to change the bread in any way. Possible answers could be that the bread is white, that it has a hard, outer portion and a soft inner portion, that it is a solid at room temperature, or that it is malleable.

Activity 2

Allow the students to test specific physical properties of solid salt (NaCl). Students can test to see whether a sample of solid salt crushes or bends when pressure is applied. Provide students

with conductivity meters and a small sample of salt. This could be done as a teacher demonstration as well. The students will observe that solid salt does not conduct electricity. The students will add the salt sample to water and observe that the salt dissolves. Upon testing the electrical conductivity of the salt water, the students will observe that the salt water does conduct electricity. Students can make a chart of salt's physical properties. A sample list of physical properties of salt is provided below.

- Solid salt is a white crystalline solid, but in water, it seems to disappear.
- Solid salt does not conduct electricity, but salt water does.
- Solid salt is soluble in water.
- Solid salt is brittle, not malleable.
- Solid salt is an ionic compound and therefore has a high boiling point.

Considerations

Dissolving is an advanced topic for students to discuss. For most students at this level, dissolving can be described as a physical change or property. Dissolving salt in water does not change salt into something new, but it does change the properties of salt on the atomic scale.

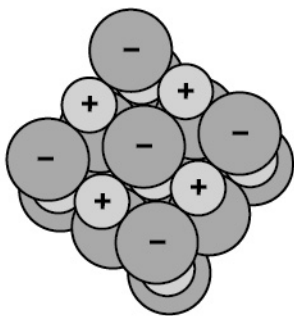

For advanced students, dissolving can be described as a chemical change or property. When salt is dissolved in water, its electrical conductivity changes, which indicates the movement of charged particles. As water molecules surround the salt ions, known as solvation, the ionic bonds are broken between the sodium and chlorine atoms. A model of salt dissolving in water is shown below.

NaCl Crystal Structure

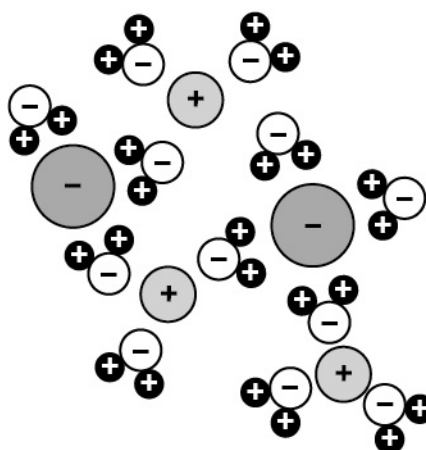

NaCl in Water



Key	
 sodium (Na)	 chlorine (Cl)

Resource

- [Dissolving](#)—list of dissolving activities from acs.org

What are some common chemical properties of substances?

Background

Pure substances have unique chemical properties. Chemical properties cannot be tested without changing the chemical nature of the matter being examined. Examples of chemical properties are included below.

reactivity: the degree to which a material chemically reacts with other substances, such as acids, copper (II) chloride, and air

flammability: how readily a substance combusts, which is related to reactivity with oxygen

heat of combustion: the difference in energy between reactants and products in a combustion reaction

Activities

Activity 1

Teachers can demonstrate a chemical property of paper (mixture). Revisit physical properties by asking students to generate a list describing several physical properties of paper (e.g., color, solubility, etc.). Tear the paper in half and ask students whether tearing the paper changed the properties of the paper. Using a match, burn a small piece of the paper. Ask students to discuss the results. Students may notice that the paper combusted easily. Carbon-based compounds, like paper, are often flammable, which is a chemical property.

Activity 2

Metal (an aluminum pop can tab or a sample of magnesium or zinc) is placed in acid (0.5M hydrochloric, 0.5M nitric, or 0.5M sulfuric) in a test tube. Students will see the metal surface changing and bubbles forming on the surface of the metal.

What can be concluded when two substances react to form a new product, but the reaction can be reversed to obtain the original reactants?

Background

There are two types of changes: physical and chemical.

A physical change does not form a new substance but may form a different version of the same substance. An example is freezing liquid water, a representation of which is shown below.

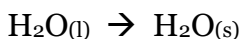

A new substance was not formed during the phase change, but solid water has different physical properties than liquid water (e.g., density, state of matter). Physical changes are considered to be reversible because the original substance can be recovered.

A chemical change forms a new substance with new physical and chemical properties. An example of a chemical change occurs when combining zinc metal and hydrochloric acid, a representation of which is shown below.



Considerations

Students commonly think that the only difference between chemical and physical changes is reversibility. The misconception is that all physical changes are reversible and that all chemical changes are not.

All chemical reactions are reversible, although reversing the reaction may be difficult practically. A chemical reaction may proceed in a forward direction and then in a reverse direction until chemical equilibrium is established. Examples of chemical reactions that are reversible are rechargeable batteries and the Haber process.

Resource

- [First Industrial Use of the Haber Process](http://environmentandsociety.org)—background information on the Haber Process from environmentandsociety.org

What evidence could be generated during an investigation to indicate the occurrence of a chemical reaction?

Background

Common indicators of a chemical reaction are the production of a gas, a change in temperature, a production of light or odor, the formation of a precipitate, and/or a change in color.

Activities and Consideration

Activity 1

Give each student group a dull penny (do not use a new shiny penny). Have the students place the penny on a paper towel. Have the students add lemon juice to the penny. After 10–15 minutes, the students will notice that the surface of the copper has changed.

Activity 2

In a test tube, combine sodium hydroxide (dissolved in water) and magnesium chloride (dissolved in water). The students will observe that the two solutions are clear. When combined, a white solid substance (precipitate) is produced, as shown in the image below.

Combination of Sodium Hydroxide and Magnesium Chloride

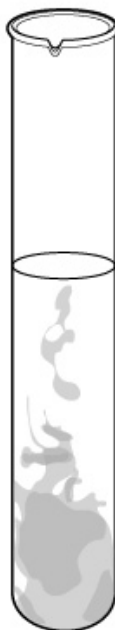

Consideration

A common misconception is that any change that involves heat is a chemical reaction. Have the students compare boiling water, which feels hot, and a chemical hot pack, in which two chemicals are combined and thermal energy is released. Are they both chemical reactions because they both feel warm? Have the students compare the formation of the white precipitate in Activity 2 and the combination of white paint and water. In both examples, the students observe a color change, but both examples are not chemical reactions.

What are some common examples of chemical reactions and physical changes?

Background

Common examples of physical changes include the following:

- phase changes (e.g., melting, freezing, vaporization, condensation)
- materials being crushed, torn, stacked
- solids being dissolved in water
- particles being mixed (e.g., sand and shells)

Common examples of chemical reactions include the following:

- cooking food (e.g., baking bread, grilling meat)
- digesting food
- combustion of materials (e.g., lighting a candle, gasoline in a car engine)
- combining baking soda and vinegar

Activity and Consideration

Activity

Set up stations for students to investigate examples of changes. They will record their observations and determine whether each change is chemical or physical. Some station examples are included below.

- Adding baking soda and vinegar to a plastic bag (chemical)
- Sorting iron filings from sand with a magnet (physical)
- Adding food coloring to water (physical)
- Melting an ice cube (physical)
- Mixing chemicals in a glow stick or jewelry (chemical)
- Dissolving sugar in water (physical, at this grade level)
- Lighting a candle (combustion is chemical; melting wax is physical)

Consideration

Many examples of reactions that students observe in their daily experiences involve multiple reactions, both chemical and physical. Students may think that reactions can only be chemical or physical.

Why do some properties of a substance change after a chemical reaction?

Background

The properties of a substance may change after a chemical reaction because the substance is different than it was before the reaction. The reactants and products of a reaction are made of the same types of atoms, but the atoms have been rearranged.

Activities and Consideration

Activity 1

Show students the model of the following chemical reaction:

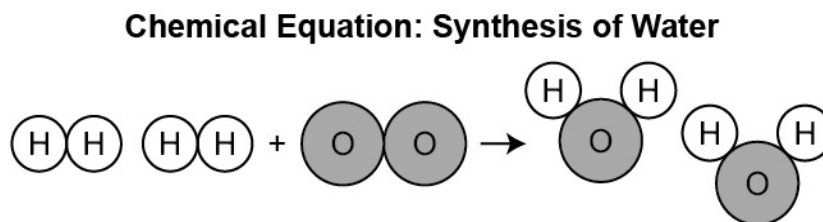

Diatomic hydrogen and oxygen are both flammable and are both gases at room temperature. Water is not flammable and is a liquid at room temperature. The reactants and products in this reaction are made of hydrogen and oxygen atoms, but the rearrangement of those atoms leads to different properties in the reactants than in the products.

Activity 2

Using the same model, the students can count the number of each type of atom on the reactant and product sides. They will determine that the number of each type of atom on each side of the arrow is the same. The only difference is how they are arranged.

Consideration

Students may think that in a chemical reaction, all the products must be different than the reactants. A catalyst (used to increase the speed at which a reaction occurs) is a good example of a reactant that is not changed during a reaction. The catalyst is the same before and after the chemical reaction takes place. When a solution of silver nitrate and a solution of sodium chloride are added together, a chemical reaction occurs. However, in that reaction, water is present as both a reactant and a product.

Resources

- [Identifying Physical and Chemical Changes Changes](#)—overview and instructional activities to identify physical and chemical changes from Victoria Education and Training
- [Chemical Reactions](#)—list of classroom activities involving chemical reactions

Grade 8
Matter and Its Interactions
8.PS.6 Create a model, diagram, or digital simulation to describe conservation of mass in a chemical reaction and explain the resulting differences between products and reactants.

Connections to *A Framework for K–12 Science Education: Practices, Crosscutting Concepts, and Core Ideas:*

Focus for Scientific and Engineering Practice(s):

- Developing and Using Models
- Engaging in Arguments from Evidence

Focus for Crosscutting Concept(s):

- Energy and Matter
- Systems and System Models

Focus for Disciplinary Core Idea(s):

- Structure and Properties of Matter
- Chemical Reactions

Key Academic Terms:

chemical reaction, conservation of mass, chemical equation, balanced equation, product, reactant, physical change, atom, yield, coefficient, subscript

Safety Considerations

Please refer to the [Alabama State Department of Education Lab Safety Guidelines](#).

How do chemical reactions differ from physical changes?

Background

Physical changes can be investigated by observing physical properties of substances. Investigating the solubility of sugar, for example, does not change the nature of sugar. Therefore, dissolving sugar in water is an example of a physical change. Chemical changes, however, change the nature of the starting substances. New substances, with new physical and chemical properties, are produced in a chemical reaction. Evidence of a chemical change may include the formation of a precipitate, a change on the surface of a solid, the production of a gas, a temperature change, a color change, and/or the production of an odor.

Activity and Consideration

Activity

Students should classify each example in the table below as a physical or chemical change.

Physical and Chemical Changes

	Physical Change	Chemical Change
Bread baking		X
Combining salt and sugar	X	
Metal rusting		X
Inflating a balloon	X	
Water freezing	X	
Mold growing on food		X

Consideration

Students may think of examples that involve a temperature change or color change that are not chemical changes. For instance, adding food coloring to water results in a color change of the water, but the nature of the food coloring and the water is the same. Likewise, heating soup in a microwave results in a temperature change, but the components of the soup are the same before and after heating.

Resource

- [Chemical and Physical Changes](#)—video resource from Generation Genius website

What is the relationship between the reactants and the products of a chemical reaction?

How can a chemical equation be used to represent a chemical reaction?

Background

Chemical reactions involve inputs (the before) and outputs (the after). The inputs are called reactants and the outputs are called products. Chemical reactions are described with chemical equations, where the reactants are written on the left side of the arrow and the products are on the right. In a chemical reaction, the reactants have different chemical and physical properties than the products do. Some examples of chemical equations are shown below.

General Equation

reactants \rightarrow products

Example



When writing a chemical formula like H_2O , the subscript indicates the number of atoms. Water has 2 hydrogen atoms and 1 oxygen atom. The large number written in front of a species (chemical substance) is called a coefficient. Coefficients represent a molar ratio between the reactants and products. At this grade level, students may understand that the coefficients are the number of “sets” required so that the same numbers and types of atoms exist before and after the reaction takes place. The process of adding coefficients to the equation is called “balancing.”

Activity

Students will add coefficients to balance the equations shown below. It may help if they inventory the atoms before adding the coefficients.

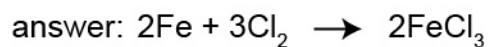
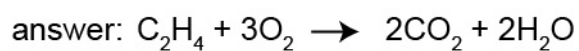
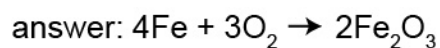
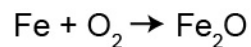

How can the conservation of mass in a chemical reaction be represented by modeling the numbers and types of atoms in both the reactants and the products?

Why is mass conserved in a chemical reaction?

Background

Matter cannot be created nor destroyed. In chemical reactions, the amount of matter (mass) is conserved. This means that the mass of the reactants equals the mass of the products. Mass is conserved in a chemical reaction because the same numbers and types of atoms exist before and after the reaction takes place. The new products that form are the result of those atoms being rearranged. An example of this is shown below.

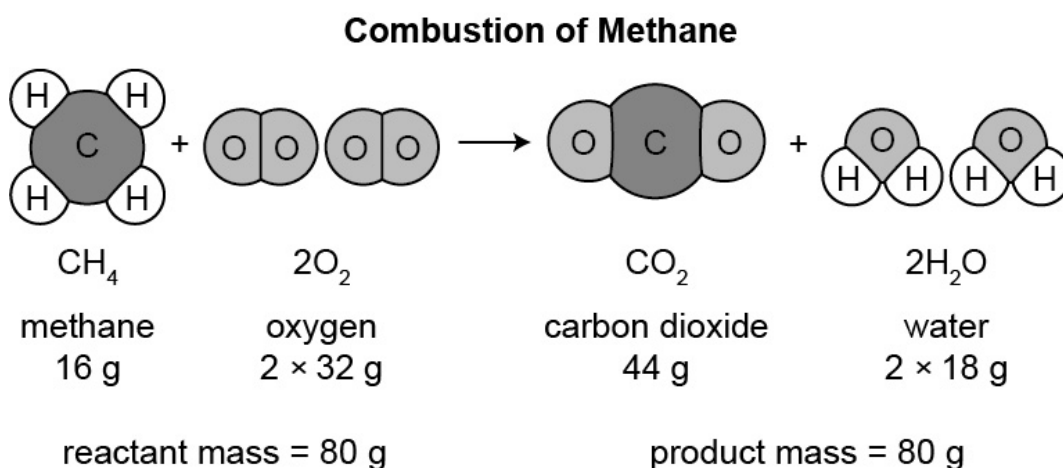

Notice that if the numbers and types of atoms are inventoried on both sides of equation, they are equal. Therefore, the mass of the reactants equals the mass of the products, as shown in the table below.

	Reactants	Products
Carbon (C)	1	1
Hydrogen (H)	4	4
Oxygen (O)	4	4

Activities

Activity 1

Demonstrate the conservation of mass in a chemical reaction by determining the mass of the reactants and then the products. A simple reaction is one that forms a precipitate. A sample process is listed below.

- 1) Add a 0.5M solution of CaCl_2 to a test tube.
- 2) Add a 0.5M solution of Na_2SO_4 to a flask.
- 3) Place the test tube inside the flask, stopper the flask, and record the mass.
- 4) Invert the flask so that the two solutions combine, forming a precipitate.
- 5) Determine the mass.

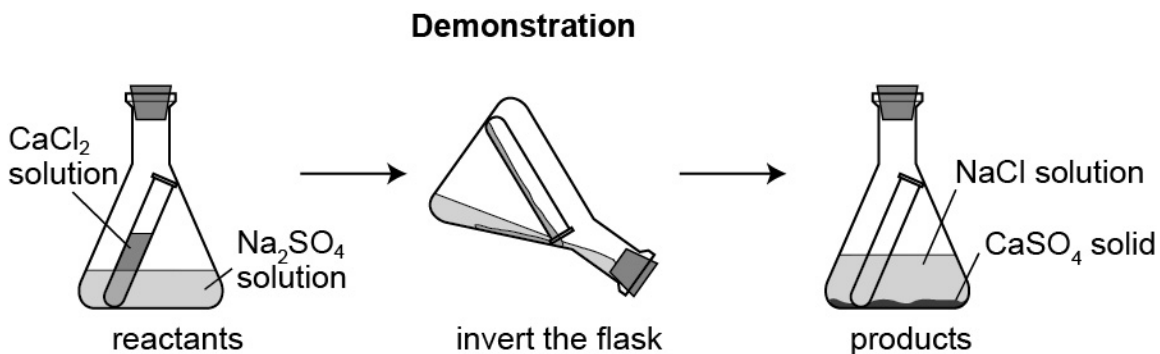

Activity 2

Students can draw molecular models of a balanced chemical equation, as shown below.

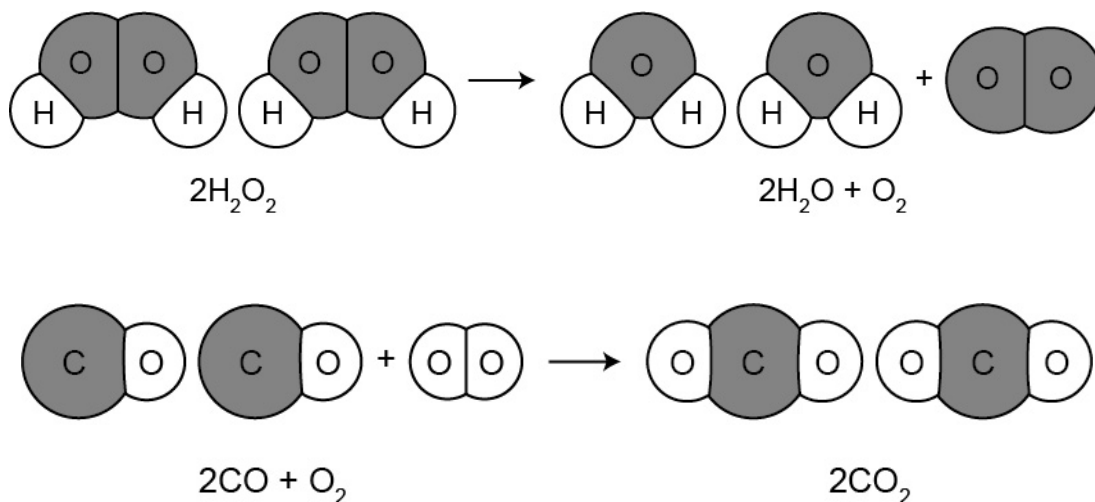

How can the apparent loss of mass during a chemical reaction be explained?

Background

Although mass is always conserved in a chemical reaction, it may appear to increase or decrease. The most common cause of this is the production of a gas in an open container. If the mass of a piece of paper was determined before and after it burned, it would seem that the mass virtually disappeared, which is a misconception. However, the products of the reaction are carbon dioxide gas and water vapor. The number of atoms before and after the paper was burned is the same, but the state of matter of the species involved changed.

Activity

A simple demonstration illustrates this misconception. Weigh a container with an amount of vinegar. Weigh out an amount of baking soda, then add the baking soda to the container with the vinegar. Observe the reaction and weigh the resulting solution. The students will observe that the total mass of the solution and container has decreased. Carbon dioxide gas was produced in the reaction and escaped from the container. Ask the students how they could capture the gas so that the conservation of mass can be verified. One possible solution is to add a balloon to the top of the flask, as shown in the representation below.

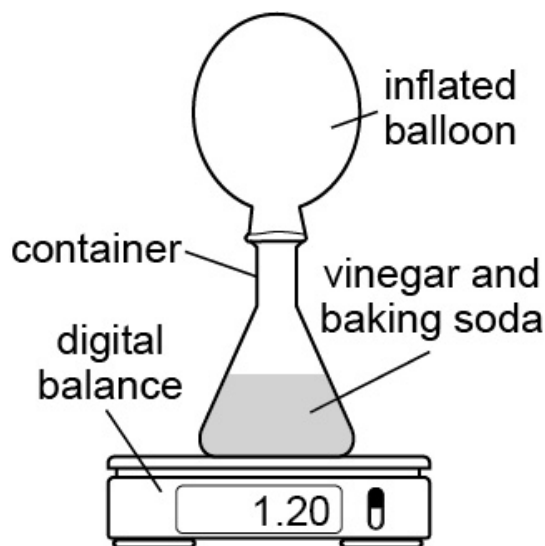

Grade 8**Matter and Its Interactions**

8.PS.7 Design, construct, and test a device (e.g., glow stick, hand warmer, hot or cold pack, thermal wrap) that either releases or absorbs thermal energy by chemical reactions (e.g., dissolving ammonium chloride or calcium chloride in water) and modify the device as needed based on criteria (e.g., amount/concentration, time, temperature).*

**Connections to A Framework for K–12 Science Education:
Practices, Crosscutting Concepts, and Core Ideas:****Focus for Scientific and Engineering Practice(s):**

- Constructing Explanations and Designing Solutions
- Planning and Carrying Out Investigations

Focus for Crosscutting Concept(s):

- Energy and Matter
- Stability and Change
- Cause and Effect

Focus for Disciplinary Core Idea(s):

- Chemical Reactions
- Developing Possible Solutions
- Optimizing the Design Solution

Key Academic Terms:

exothermic, endothermic, chemical reaction, chemical bond, engineering process, thermal energy, criterion, potential energy, bond energy, stored energy, design solution

Safety Considerations

Please refer to the [Alabama State Department of Education Lab Safety Guidelines](#).

What is thermal energy?

How do endothermic reactions differ from exothermic reactions in terms of energy inputs and outputs?

How do chemical reactions differ from physical changes?

How does a chemical reaction release or absorb thermal energy?

Why do some reactions release energy when energy is required to break chemical bonds?

How is reactant and product stability related to exothermic and endothermic reactions?

Background

Thermal energy is the energy an object has due to the particle motions in that object. Particles in a sample of helium gas are moving faster than particles in a sample of solid aluminum. Therefore, the sample of helium has more thermal energy than the sample of aluminum.

Chemical reactions involve breaking bonds and forming bonds. In order to break bonds, energy is always required. Forming bonds always releases energy. The nature of the reactants and products determines whether there is an excess of energy available after the products are formed. Thermodynamics can be compared to an exchange of money. For chemical reactions to take place, the bonds of the reactants must be broken, which requires energy (requires a payment). When the products form, bonds are formed, which releases energy (gives money back). Reactions that require more money than is paid back will result in a reaction that is endothermic. Reactions that give more money back than was required as payment are called exothermic reactions. A graphic explanation of endothermic and exothermic reactions is provided below.

Endothermic vs. Exothermic Reactions

energy + reactants \longrightarrow products (endothermic)

reactants \longrightarrow products + energy (exothermic)

Activities and Consideration

Activity 1

Have students create energy diagrams for endothermic and exothermic reactions.

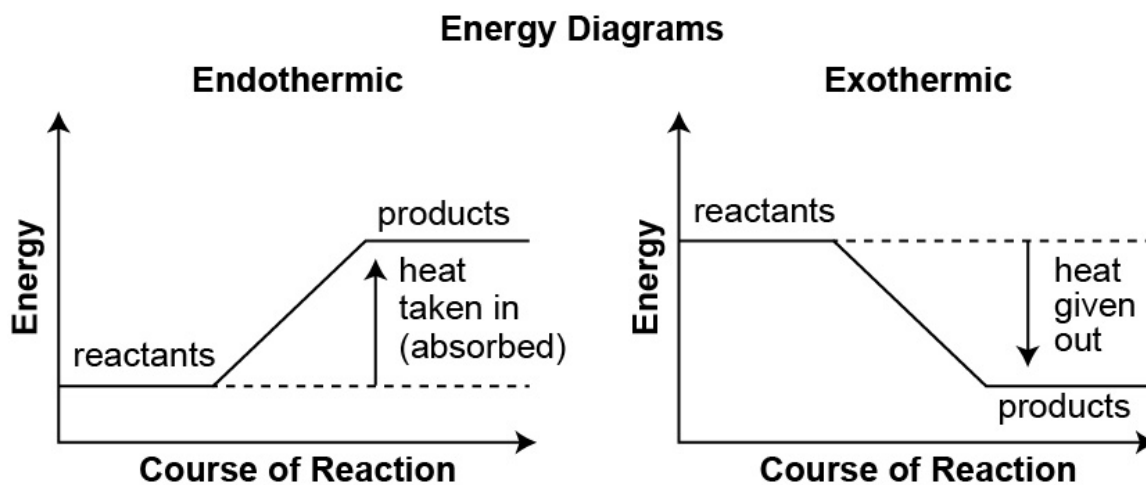

Systems are more stable when energy is low. Based on the energy diagrams, students can predict that in endothermic reactions, the reactants are more stable, and in exothermic reactions, the products are more stable.

Activity 2

Physical changes, such as a phase change, can also be categorized as endothermic or exothermic. For a solid to change to a liquid, the attractive force between particles must weaken. Students can conceptualize this process as bond breaking, which requires the input of energy. Ask students to use molecular modeling of solids, liquids, and gases to determine which phase changes are endothermic and exothermic. A sample answer is provided below.

Endothermic: melting, vaporization, sublimation

Exothermic: freezing, condensation, deposition

Consideration

Since endothermic reactions require an input of energy, the temperature of the surroundings (where the energy came from) decreases. Since exothermic reactions release energy to the surroundings, the temperature of the surroundings increases.

How would a student experimentally determine whether a chemical reaction releases thermal energy or absorbs thermal energy, overall?

Background

Recall that endothermic reactions result in a decrease in the temperature of the surroundings and exothermic reactions result in an increase in the temperature of the surroundings.

Activities

Activity 1

Place acetone in a test tube. Place a thermometer in the test tube for 1 minute and record the temperature. Remove the thermometer and allow the acetone to evaporate. Record the temperature. Students will notice a decrease in temperature as the acetone evaporates. This indicates that for a liquid to change into a gas, energy must be added to the system.

Phase Change Representation

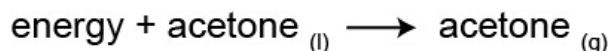

Activity 2

In small groups or as a demonstration, fill an aluminum can halfway with cool water. Record the initial temperature of the water. Place a candle under the can, light the candle, and let it burn for 5 minutes. Record the final temperature of the water. Students will notice that the temperature of the water increases. This suggests that energy was absorbed by the water. Students may think this means that an endothermic reaction took place. It is important for students to differentiate the system from the surroundings. In this case, the chemical reaction taking place was the combustion of paraffin wax. The combustion of paraffin is the system. The system released energy, so the reaction is exothermic.

Combustion of Paraffin

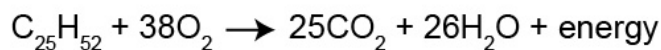

The water is the surroundings in this activity. The energy released from the combustion of paraffin was transferred to the water.

What are the steps and processes involved in the engineering design process?

What is the purpose of criteria when developing an engineering device?

Background

Devices are frequently designed by engineers that utilize thermodynamics concepts. While each design process differs, many of them have the following basic steps:

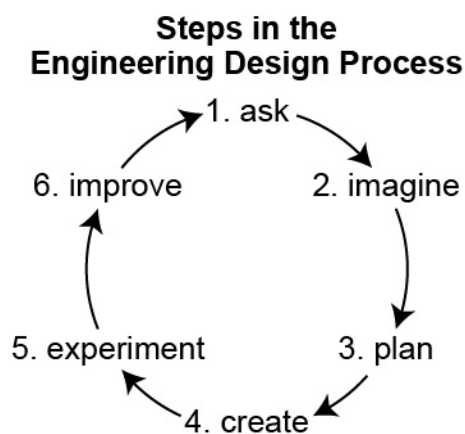

The purpose of determining the criteria for a design is to examine the goal of the project. Aspects of the project that may be considered include the following:

- Energy consumption
- Inputs/outputs
- Undesirable side effects
- Cost
- Safety
- Repeatability

Resources

- [The Engineering Design Process](#)—resource about the engineering design process from sciencebuddies.org
- [Thermochemistry and Thermodynamics Unit Plan](#)—curriculum resource from teachchemistry.org

Grade 8**Motion and Stability: Forces and Interactions**

8.PS.8 Use Newton’s first law to demonstrate and explain that an object is either at rest or moves at a constant velocity unless acted upon by an external force (e.g., model car on a table remaining at rest until pushed).

Connections to *A Framework for K–12 Science Education: Practices, Crosscutting Concepts, and Core Ideas:***Focus for Scientific and Engineering Practice(s):**

- Constructing Explanations and Designing Solutions

Focus for Crosscutting Concept(s):

- Cause and Effect
- Patterns
- Energy and Matter

Focus for Disciplinary Core Idea(s):

- Forces and Motion

Key Academic Terms:

force, speed, velocity, Newton’s first law, inertia, constant velocity, balanced force, unbalanced force, potential energy, kinetic energy, contact force, noncontact force, net force, distance, time, scalar, vector, motion

Safety Considerations

Please refer to the [Alabama State Department of Education Lab Safety Guidelines](#).

What is the difference between kinetic and potential energy?

What is the difference between speed and velocity?

What is constant velocity?

Background

Potential energy is stored energy and can be described as the energy an object has based on its position relative to another object. For instance, an apple on top of a ladder has more potential energy than an apple located on the floor. The formula for calculating potential energy is shown below.

$$PE = mgh$$

$$m = \text{mass}$$

$$g = \text{acceleration due to gravity}$$

$$h = \text{height}$$

Kinetic energy is the energy an object has due to movement. An object that is traveling at 10 miles per hour has more kinetic energy than an object that is traveling at 1 mile per hour. The formula for calculating kinetic energy is shown below.

$$KE = 0.5mv^2$$

$$m = \text{mass}$$

$$v = \text{velocity}$$

Since kinetic energy is determined by the motion of an object, the velocity of the object is a key factor. The speed of an object is the distance an object travels over a period of time. The formula for calculating speed is shown below.

$$s = \frac{d}{t}$$

$$s = \text{speed}$$

$$d = \text{distance}$$

$$t = \text{time}$$

Velocity is similar to speed (it is calculated the same way), but it also includes a direction. Speed is a scalar quantity because it only has a magnitude. Velocity is a vector quantity because it has both a magnitude and a direction. Constant velocity is when an object is moving at a constant speed and in a straight path. A ball rolling at a speed of 1 meter/second in a straight line has a constant velocity. The same ball rolling at the same speed but in a circle does not have a constant velocity because the direction is changing.

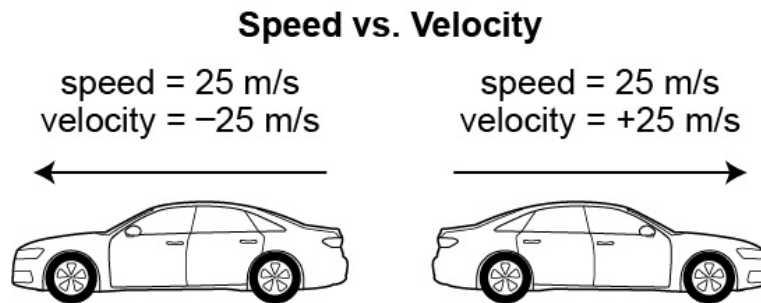

Activity and Consideration

Activity

Students can interpret the following graphics to determine whether kinetic energy, potential energy, or both types of energy are present.

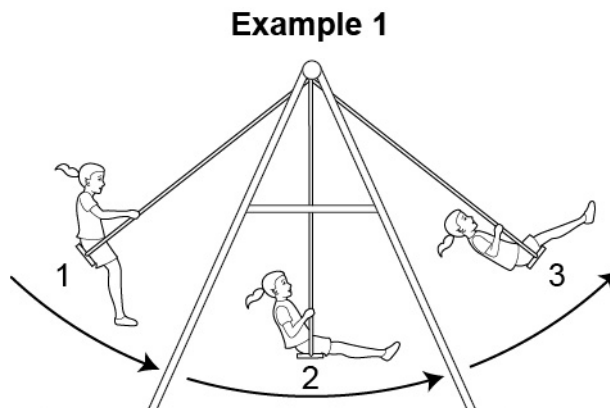

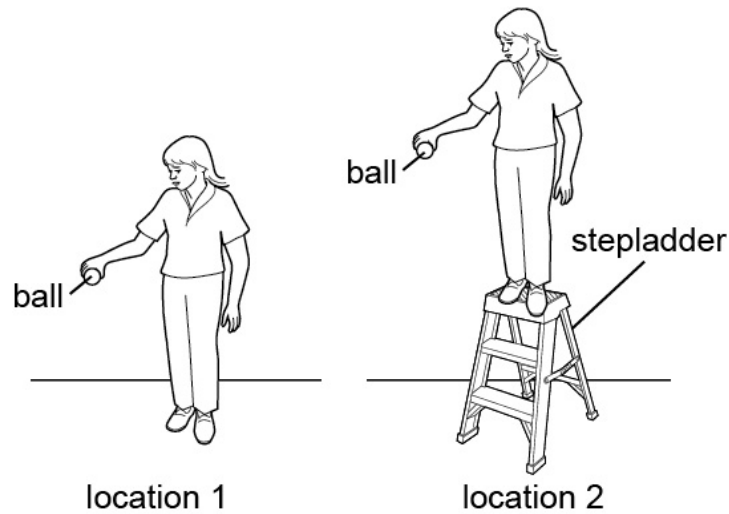
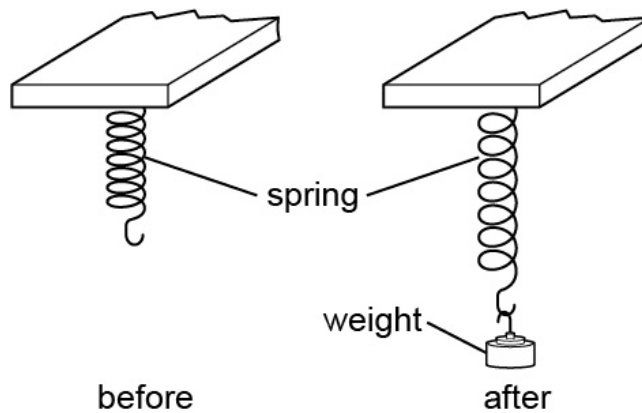
Example 2**Example 3****Consideration**

Students should understand that energy is conserved. If the students describe an object in one of the pictures as having only potential energy, the kinetic energy is zero. If the object begins to move, potential energy is converted to kinetic energy. The graphic below shows energy conversion on a roller coaster.

Energy Conversion on a Roller Coaster

kinetic energy: 0
potential energy: 100

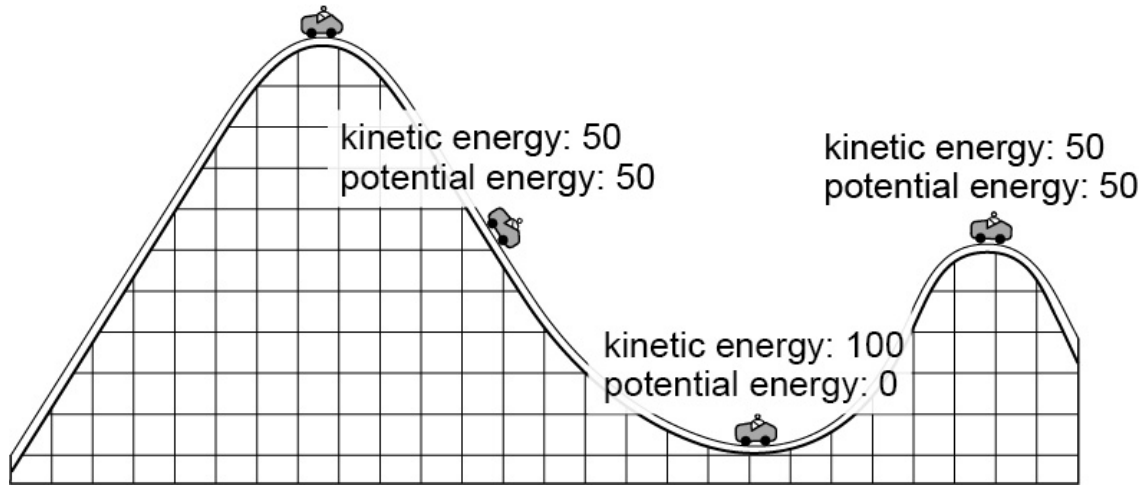

How can an external force be described?

How do unbalanced and balanced forces compare in terms of how they affect motion?

What is Newton's first law and how can it be demonstrated?

What must be overcome for an object to move?

Background

Forces are categorized as either internal or external. Examples of internal forces include gravity force, magnetic force, and electrical force. Example of external forces include normal force, applied force, tension force, friction force, and air resistance. When work is done on an object by an external force, the total mechanical energy (kinetic and potential) of the object changes.

Force can also be classified as balanced or unbalanced. A balanced force results in a constant state of motion. Balanced forces are forces that are in opposite directions and have the same magnitude. Unbalanced forces result in a change in motion of an object. The unit for force is Newtons (N). Examples of balanced and unbalanced forces are shown below.

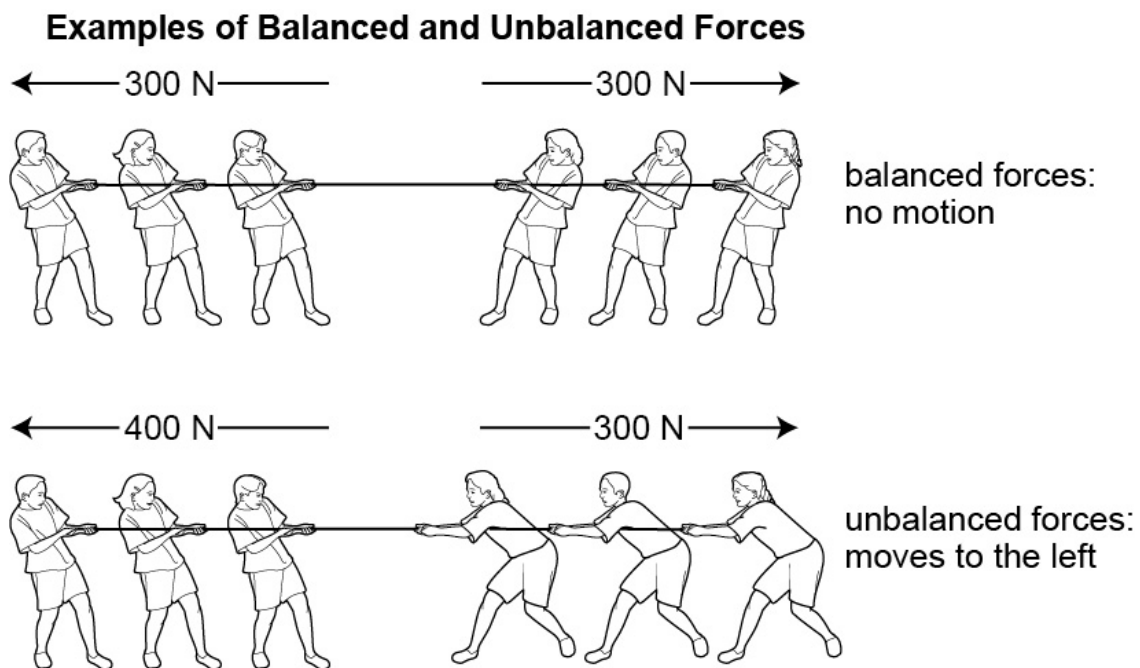

Newton's First Law of Motion states that an object in motion stays in motion (at a constant speed) and an object at rest stays at rest unless acted on by an unbalanced force. A ball at rest will stay at rest (velocity = 0 m/s) if the forces are balanced. If someone pushes the ball (applied force), causing unbalanced forces, the ball's motion changes.

Activity

Newton's First Law of Motion can be demonstrated in the following ways:

1. Spin a top on a table or use a fidget spinner. Ask the students to use Newton's 1st Law to describe why the top or spinner eventually comes to a stop.
2. Throw a paper airplane upward and ask the students to use the terms unbalanced force, balanced force, rest, and velocity to describe the airplane's motion.

Which factors affect the amount of inertia an object has?

Background

Newton's First Law of Motion uses the concept of inertia to describe an object's motion. Inertia is an object's resistance to changing its motion. All objects have inertia, although some have more than others depending on mass. Objects that have more mass have more inertia.

Activity

As a demonstration or in small groups, place a piece of cardboard on top of a plastic cup. Place a coin on top of the cardboard. Flick the cardboard quickly to make the coin fall straight down in the cup. Ask students to use the term inertia to explain why the coin didn't move in the same direction as the cardboard. How would this change if the object on the cardboard was more massive?

Coin Drop Demonstration

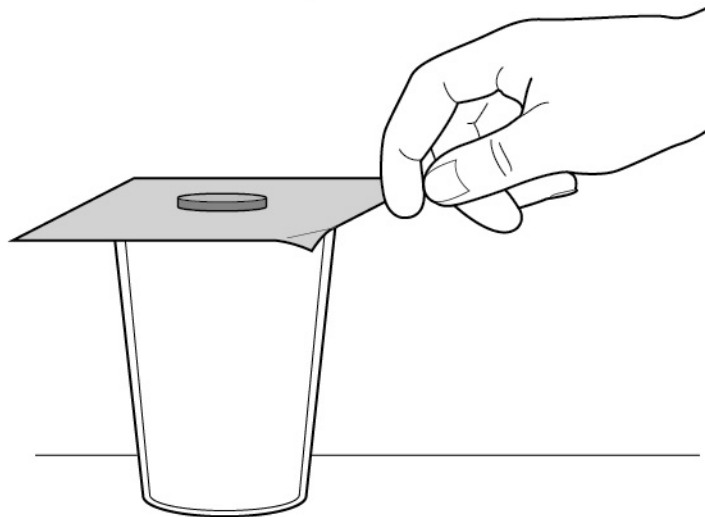

Other everyday examples of inertia include the following:

1. A semitruck and a small car are sitting at a red light. Which one is more difficult to accelerate (change velocity)?
2. A passenger in a car is holding a full cup of water, and the car suddenly comes to a stop. The water in the cup spills out, even when the cup doesn't fall.

What must occur for a moving object to collide with a stationary object and the stationary object to then move?

Background

Elastic collisions between objects may affect the objects' motion, depending on the scenario. Some example scenarios are shown below.

Scenario 1: Equal Masses

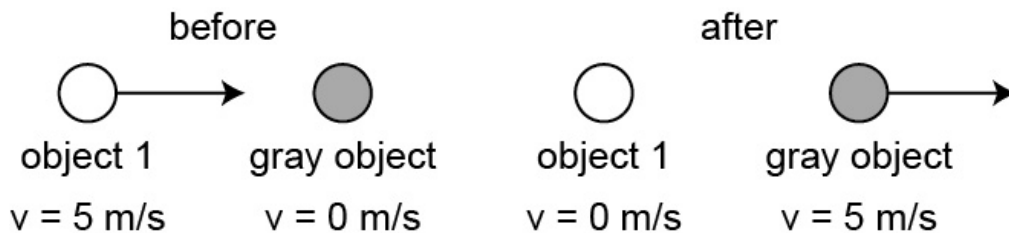

Scenario 2: Unequal Masses

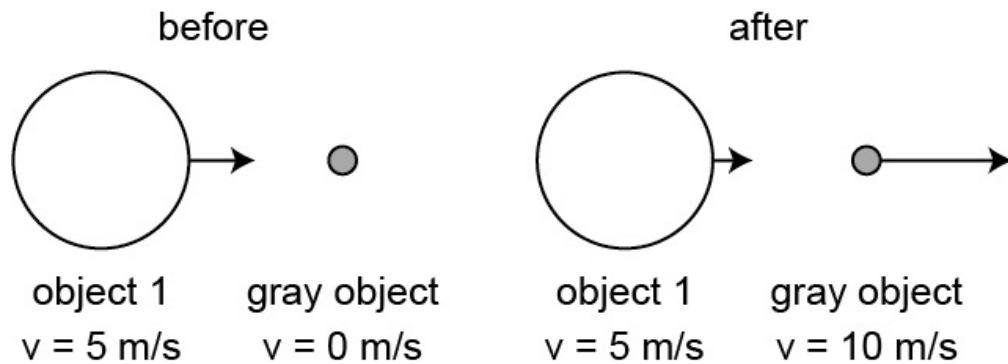

Scenario 3: Unequal Masses

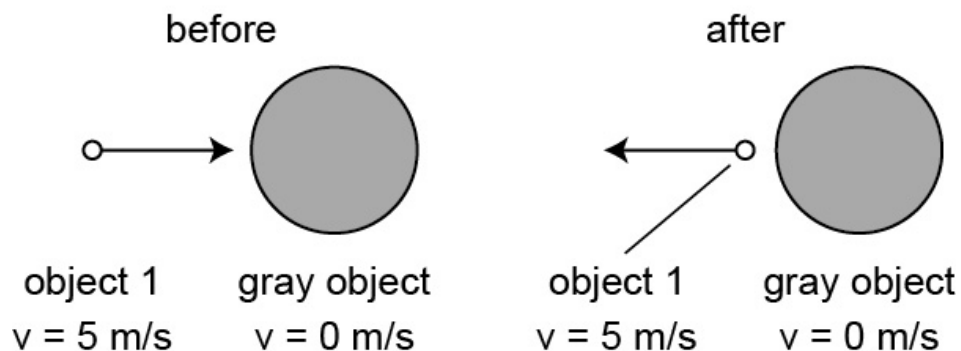

Activity and Consideration

Activity

Educators can demonstrate the scenarios in the background using basic materials from the classroom.

Materials:

- Plastic cups
- Coins
- Marbles or metal ball bearings of varying masses
- Meterstick
- Cardboard
- Books

Directions:

1. Set up a ramp on which the marble will roll.
2. Cut a hole in one side of the cup as shown below.
3. Set the ramp up with the meterstick and books.
4. Place the cup at the bottom of the ramp with its opening facing the meterstick.
5. Roll the marble down the ramp and into the plastic cup.
6. Have students measure how far the cup moves after the marble collides with it.
7. To vary the investigation:
 - a. Add or remove books under the ramp to change the speed of the marble rolling down the ramp.
 - b. Add coins to the top of the cup to vary the mass of the cup.

Marble Investigation

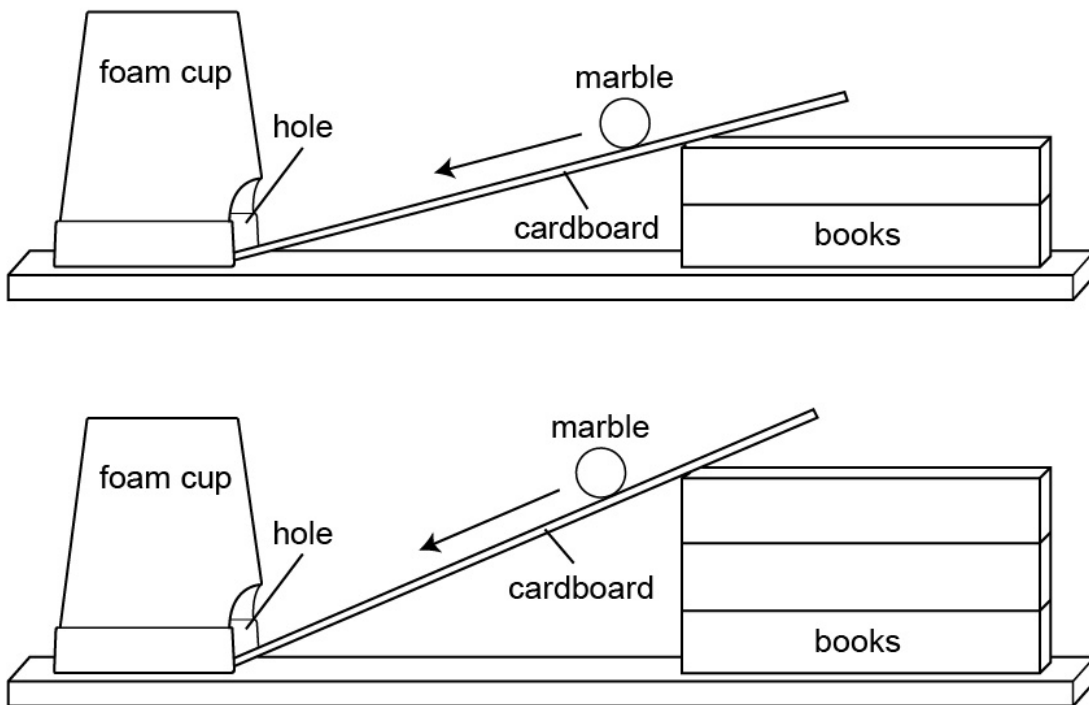

Questions that can be investigated include the following:

1. How is the motion of the cup affected when the marble's mass increases?
2. How is the motion of the cup affected when the angle of the ramp increases or decreases?
3. How is the motion of the cup affected when the mass of the cup increases as coins are added to the top of the cup?

Consideration

The calculation for momentum and vocabulary related to inelastic collisions are included below.

$$\text{momentum (p)} = \text{mass (m)} \times \text{velocity (v)}$$

elastic collision: external forces (like friction) are not present; momentum and kinetic energy are conserved

inelastic collision: objects stick together upon a collision; the final velocity of both objects is the same and kinetic energy is not conserved

Resource

- [Forces and Motion](#)—PhET simulation that requires JAVA to run.

Grade 8**Motion and Stability: Forces and Interactions**

8.PS.9 Use Newton’s second law to demonstrate and explain how changes in an object’s motion depend on the sum of the external forces on the object and the mass of the object (e.g., billiard balls moving when hit with a cue stick).

Connections to *A Framework for K–12 Science Education: Practices, Crosscutting Concepts, and Core Ideas*:**Focus for Scientific and Engineering Practice(s):**

- Developing and Using Models
- Constructing Explanations and Designing Solutions

Focus for Crosscutting Concept(s):

- Stability and Change
- Cause and Effect
- Patterns

Focus for Disciplinary Core Idea(s):

- Forces and Motion

Key Academic Terms:

force, mass, external force, Newton’s second law, force diagram, balanced force, unbalanced force, speed, acceleration, velocity, distance, time, gravity, scalar, vector

Safety Considerations

Please refer to the [Alabama State Department of Education Lab Safety Guidelines](#).

What is Newton's second law and how can it be demonstrated?

How can the relationship between velocity, speed, and acceleration be described?

How does mass affect the motion of an object on a flat surface?

How does mass affect the motion of an object down an incline (ramp)?

Background

Newton's second law states that the sum of the forces acting on an object is equal to the object's mass multiplied by its acceleration. The law is commonly written using the equation shown below.

$$F = ma$$

A common misconception is that this equation can yield a specific value of force when, in fact, F is equal to the sum of all the forces (the net force) acting on an object. Newton's equation can be re-arranged and presented in the following additional ways:

$$a = \frac{F}{m} \qquad m = \frac{F}{a}$$

Using Newton's law arranged for acceleration can set a frame of reference for students and help them to better internalize the variables. Acceleration is observable, and the formula shows that it is directly proportional to the forces acting upon an object and inversely proportional to the object's mass.

Speed, velocity, and acceleration are similar to each other. The table below summarizes these three concepts.

Vocabulary Word	Description	Equation	Unit
Speed	Speed is calculated by finding the distance an object traveled and dividing by the duration.	$s = \frac{d}{t}$	m/s
Velocity	Velocity requires a direction in addition to distance. The delta represents this and is called displacement.	$v = \frac{\Delta d}{t}$	m/s and a vector that shows direction
Acceleration	A change in velocity over time.	$a = \frac{V_f - V_i}{t}$	m/s ² and a vector that shows direction

On a flat surface, when the force is constant, as the mass of an object increases, the acceleration will decrease because mass and acceleration are inversely related. If the force is increased and mass is kept constant, the acceleration will increase because force and acceleration are directly related.

On an inclined plane, all objects accelerate at the same rate regardless of their masses. This occurs because gravity accelerates all objects at a constant rate.

Activity

Students can use a Newton scale to measure force and attach it to a device where the mass can be manipulated. Quantitative data can be collected to find acceleration by using a stopwatch and meterstick, or qualitative observations can be used to describe the characteristics of Newton's second law.

Resources

- [Newton's 2nd Law of Motion](#)—video showing astronaut Randy Bresnik demonstrating the second law on the International Space Station from STEMonstrations
- [Push Harder: Newton's Second Law](#)—lesson plan that can be conducted using technology like a cell phone or tablet or using traditional methods like a meterstick and stopwatch from sciencebuddies.org
- [Problem, Solution, Construction, Equations](#)—short YouTube videos that can serve as a follow-up or bell ringer activity
- [Static and Kinetic Friction on an Inclined Plane](#)—physics simulation that allows for the manipulation of variables on an inclined plane from ophysics.com

How can external forces be described?

How do unbalanced and balanced forces compare in terms of how they affect motion?

How can a force diagram be used to demonstrate how forces affect the motion of an object?

How can the sum of external forces result in no motion of a stationary object?

Background

An external force is any applied force on an object. Common examples of applied forces are listed below.

- Pushes and pulls
- Tension
- Friction
- Normal force

If the net force acting on an object is balanced, then there will be no observable motion, while an unbalanced net force will result in motion. Force diagrams (free body diagrams) illustrate how external forces act on objects and help the viewer determine the motion of the object involved. Force diagrams are constructed using vectors so that the viewer can determine whether the forces involved should be added together or subtracted from each other. Vectors that move in the same direction are added, and vectors that move in opposite directions are subtracted. The value determined by the magnitude of the vectors tells the viewer the amount of force and the direction of the largest magnitude shows where the object will move.

Force Diagrams

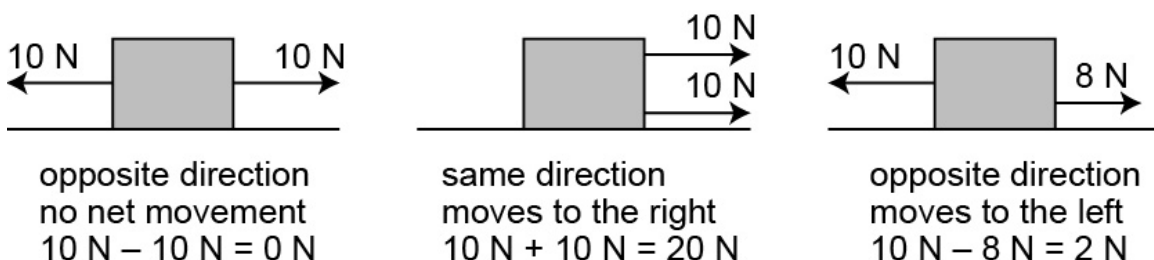

Objects can move in diagonal directions but use of the Pythagorean theorem is required to find an accurate solution.

Perpendicular Force Diagram

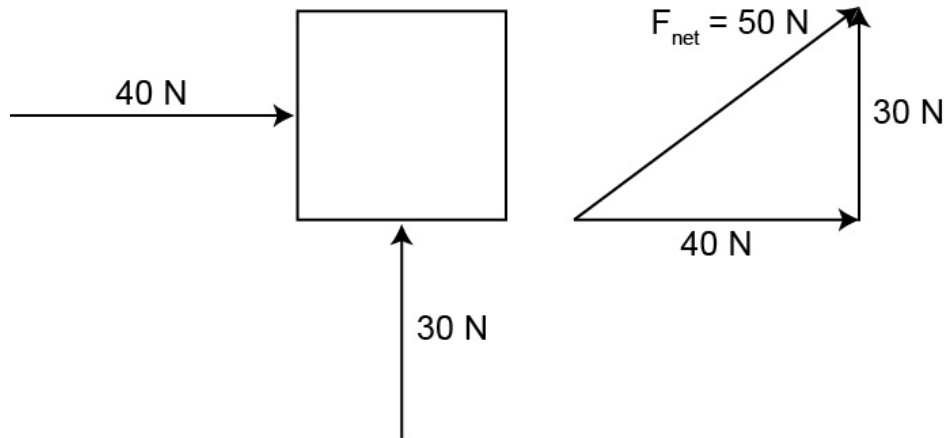

Activities

Activity 1

Create a series of force diagrams and have students work in pairs to find a solution for the net force and direction of movement for each diagram. This can be done using a worksheet or a digital tool like Kahoot, Quizizz, or Quizlet.

Activity 2

Students can participate in an arm-wrestling competition and create force diagrams to model the matches that took place.

Resources

- [Kahoot Force Diagrams](#)—digital quiz game that students can play, and educators can modify by creating an account
- [Quizizz](#)—digital quiz game that has students work at their own pace and can be assigned as homework or done live in class
- [Quizlet](#)—This website provides digital flash cards that can be created by students or educators. Educators can also use a set to play an in-class game called Quizlet Live where students compete in teams.

Grade 8
Motion and Stability: Forces and Interactions
8.PS.10 Use Newton’s third law to design a model to demonstrate and explain the resulting motion of two colliding objects (e.g., two cars bumping into each other, a hammer hitting a nail).*

Connections to *A Framework for K–12 Science Education: Practices, Crosscutting Concepts, and Core Ideas:*

Focus for Scientific and Engineering Practice(s):

- Constructing Explanations and Designing Solutions
- Developing and Using Models

Focus for Crosscutting Concept(s):

- Stability and Change
- Cause and Effect
- Systems and System Models

Focus for Disciplinary Core Idea(s):

- Forces and Motion

Key Academic Terms:

Newton’s third law, force, motion, collision, force diagram, speed, distance, time, action force, reaction force

Safety Considerations

Please refer to the [Alabama State Department of Education Lab Safety Guidelines](#).

What is Newton's third law and how can it be demonstrated?

How can a force diagram be used to model and explain Newton's third law?

What happens to the forces involved when a hammer strikes a nail?

What evidence (measurements) needs to be collected to determine the motion of two colliding objects?

Background

Newton's third law centers around the concept of force pairs. For every force (action) there is another force that acts in the opposite direction with the same magnitude (reaction). Even though the pairs are equal and opposite, that does not mean that there is no net movement.

For example, a rocket taking off will exert an equal and opposite force with the gases that are being expelled. This exchange remains constant, but the mass of the rocket changes, which in turn changes the effect felt by the rocket due to Newton's second law. As the mass decreases with a constant application of force, the acceleration of the rocket increases.

Application of Newton's Third Law

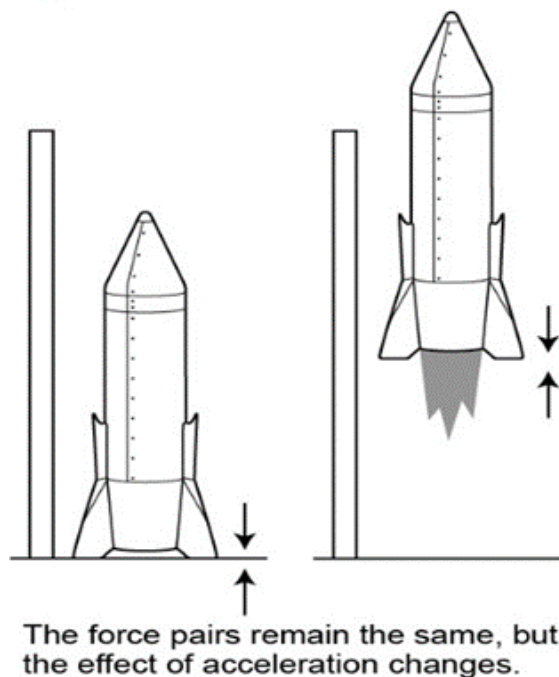

When a hammer strikes a nail, there is an equal and opposite force between the two objects. Due to the difference in mass, the heavy hammer experiences very little acceleration, while the nail, due to its small mass, experiences a high amount of acceleration.

Force Diagram and Resulting Motion

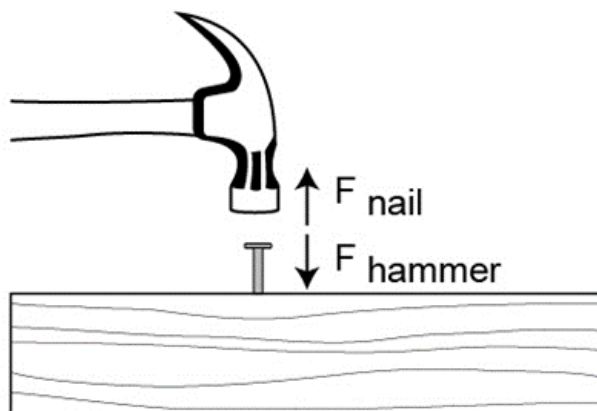

The hammer remains in almost the same location where it struck the nail, while the nail moves into the wood.

Activity

Students can use Newton's third law to explain the observed movement of propulsion using school-appropriate materials. If balloons are acceptable, various devices can be constructed to show propulsion. If balloons are not acceptable, fans or paddles driven by elastic bands can be used as an alternative.

Some alternatives to using balloon propulsion are shown on the next page.

Fan Propulsion

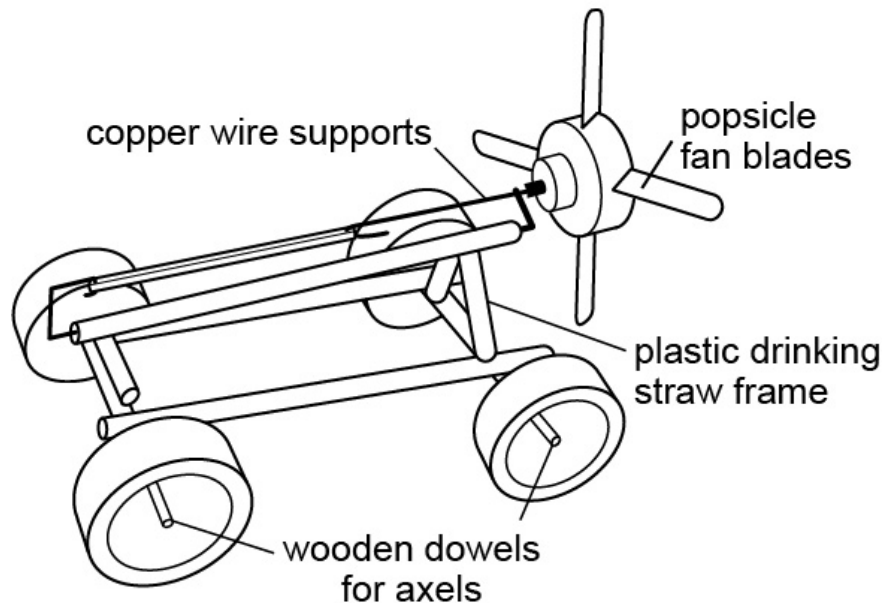

Water Propulsion

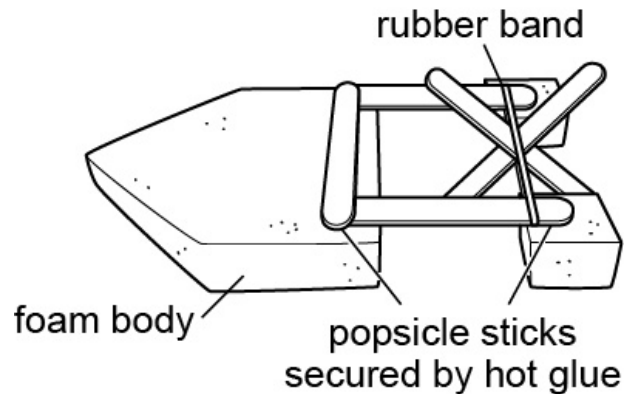

Resources

- [Newton's Third Law](#)—YouTube video from the Physics Classroom Channel that starts at 4:08
- [Action and Reaction](#)—This YouTube video from Professor Dave starts at 1:36. The video shows the hammer and nail example and explains the resulting motion of the nail.
- [Get Me Off This Planet](#)—lesson plan from Teach Engineering website that uses all three of Newton's Laws
- [Sonoma University](#)—lesson plan created in partnership with Goddard Space flight center that is the third part of the lesson series that goes through each of Newton's Laws

How can the result of a collision between two objects be modeled and explained, and how are those models and explanations changed if the masses or speeds of the objects are unequal?

Background

When objects collide, the collision can be classified as either elastic or inelastic. When an elastic collision occurs (which rarely happens in real life) it is assumed that all kinetic energy is transferred during the collision. In an inelastic or partially elastic collision, kinetic energy is transferred to another type of energy (thermal, sound, light, etc.)

Depending on the type of collision and the mass of the objects involved, the movement after the collision will be different. It is important to note that conservation of momentum is a key part of understanding the change in velocities but is out of scope for this grade level. Individual educators may choose how closely they wish to cover this topic based on their own experience and knowledge level.

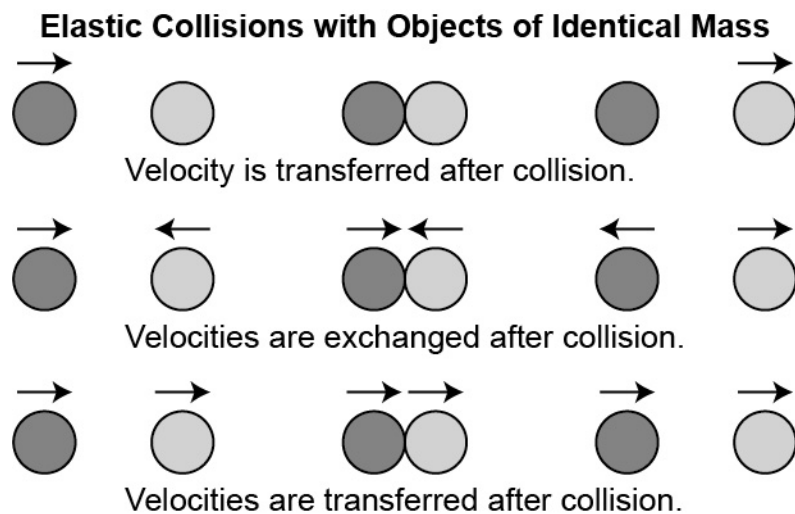

Elastic Collisions with Objects of Unequal Mass



Smaller mass changes direction and moves faster, while larger mass changes direction and moves slower.



Smaller mass changes direction and moves slower, while larger mass moves in the direction of the initial motion faster.



Smaller mass is at rest, while larger mass maintains direction and moves faster.

Inelastic Collisions with Objects of Identical Mass

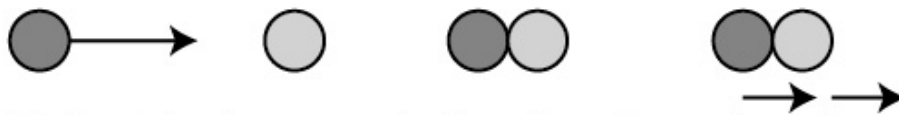

Both objects move in the direction of motion at half the initial velocity.



Objects with the opposite velocities result in no motion after the collision.



Objects with different velocities result in motion after the collision with a combined velocity.

Inelastic Collisions with Objects of Unequal Mass



Both objects move in the direction of motion at half the initial velocity.

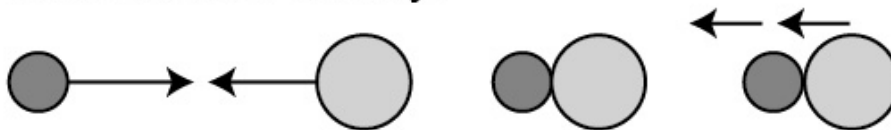

Objects will move in the initial direction of the larger mass at half the initial velocity.

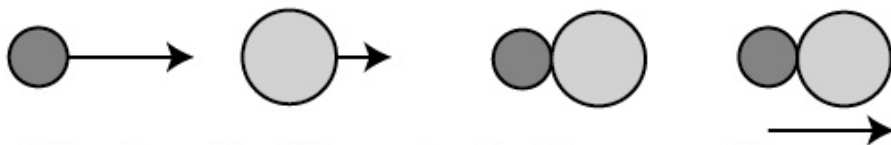

Objects with different velocities result in motion after the collision with a slower velocity.

Activities

Activity 1

Students can use rulers and ball bearings to study collisions and observe their effect. Aspects of engineering can be used as students refine their investigation setup to limit or reduce error for control variables (speeds of the ball bearings).

Activity 2

Students can make cannons by using effervescent antacid tablets, water, and film canisters. These cannons can be used to study Newton's Third Law and collisions. Students should use metersticks to construct a lane that can contain the canisters as they move and gather quantitative data. Film canisters can be purchased from online retailers like Amazon or eBay.

Resources

- [Collision Design Solution](#)—NGSS-aligned lessons from the Wonder of Science website that deal with Newton’s Third Law
- [Film Canister Cannon](#)—lesson plan from MnSTEP website that includes materials list, directions, and student lab sheet
- [Collision Simulation](#)—Flash simulation from PhET that may not work after January 2021
- [Collision Simulation](#)—HTML 5 simulation similar to PhET that includes dynamic graphs for velocity and momentum
- [Collision Simulation](#)—HTML 5 simulation similar to PhET hosted by a German science teacher on a personal webpage
- [Bumper Car Collisions](#)—guided animation from cK-12 website
- [Newton’s Laws of Motion](#)—guided investigation for students with the third law on page 6–8 hosted by the Kyrene school district in Tempe, Arizona

Grade 8**Motion and Stability: Forces and Interactions**

8.PS.11 Plan and carry out investigations to evaluate how various factors (e.g., electric force produced between two charged objects at various positions; magnetic force produced by an electromagnet with varying number of wire turns, varying number or size of dry cells, and varying size of iron core) affect the strength of electric and magnetic forces.

**Connections to A Framework for K–12 Science Education:
Practices, Crosscutting Concepts, and Core Ideas:****Focus for Scientific and Engineering Practice(s):**

- Developing and Using Models
- Planning and Carrying Out Investigations
- Constructing Explanations and Designing Solutions

Focus for Crosscutting Concept(s):

- Stability and Change
- Cause and Effect

Focus for Disciplinary Core Idea(s):

- Forces and Motion
- Types of Interactions
- Stability and Instability in Physical Systems

Key Academic Terms:

investigation, electric force, magnetic force, electromagnetic force, dry cell, iron core of electromagnet, charged object, voltage, conductor, insulator, electron, resistance, current, circuit

Safety Considerations

Please refer to the [Alabama State Department of Education Lab Safety Guidelines](#).

How do magnetic forces, electrical forces, and electromagnetic forces compare to one another?

What is the relationship between two charged particles that are brought together?

Background

Magnetic forces and electrical forces are both categorized as electromagnetic forces. These are non-contact forces that share many similarities. These forces involve charged particles that can exert both attractive forces and repulsive forces. Electromagnetic charges with the same charge repel each other, while opposite charges are attracted to each other.

A major difference between electric and magnetic forces is that a positive or negative charge can exist independently (due to static induction). Magnetic charges will always consist of a positive and negative pair, which is called a dipole. The similarities and differences between these two types of forces are summed up in the image below.

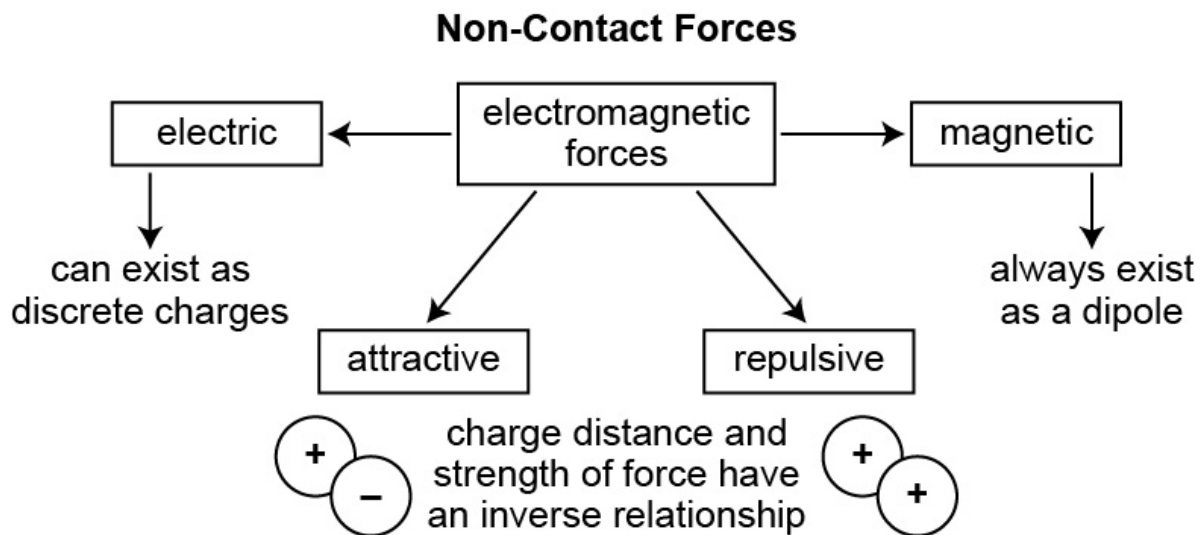

Activity

Have students discuss the similarities and differences between electric forces and magnetic forces. Then, have students construct a T-chart or a flow model to represent this information.

Resources

- [Electromagnetic Induction](#)—Veritasium YouTube video that shows how current produces magnetic fields; it also shows a transfer of energy during the induction process
- [Force Field Motion Dampening](#)—YouTube video from the NightHawkInLight channel that discusses electromagnetic braking techniques (starting at 4:33)

What materials are needed to build a simple electromagnet?

How does varying the number of dry cells affect the strength of an electric force?

From a given investigation plan, what types of data are needed to explain how forces affect the strength of electric and magnetic forces?

How would a student demonstrate how various factors can affect the strength of electric, magnetic, and electromagnetic forces?

Background

To build an electromagnet, the following materials are required:

- 1 battery (AA, C, D or 9V)
- Insulated copper wire (22-gauge or higher works best)
- 1 metal core (ideally iron), such as a nail

The copper wire should be coiled around the metal core several times before its ends are connected to the terminals of the battery.

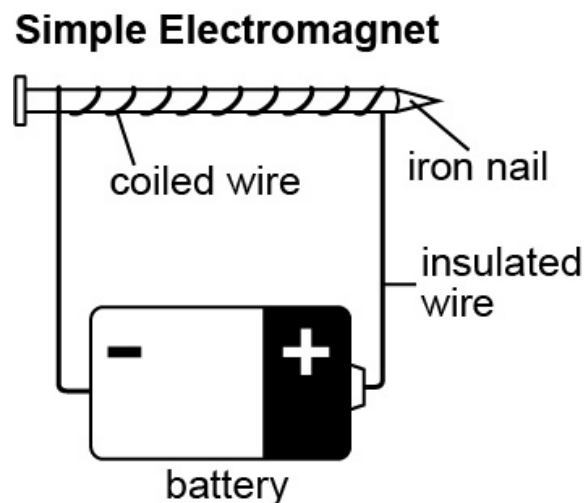

An electromagnet cannot be indefinitely strengthened by adding more batteries to the system. As the voltage of the system increases, so does the temperature and resistance in the wire. As

resistance increases, a voltage limit is eventually reached, and the strength of the electromagnet can no longer increase.

Students can use qualitative observations to assess the perceived strength of an electromagnet. This type of data collection may include observations such as the amount of material attracted to the magnet or the change in distance of the attractive force. To construct investigations focused on this type of data collection, the following variables may be manipulated:

- Type of battery used
- Quantity of batteries in the system
- Number of coils in the wire
- Presence of a core
- Type of core (nonmetallic vs. metallic; type of metal)

Activities

Activity 1

Have students construct an electromagnet and manipulate variables to investigate the effects on the strength of the magnetic field.

Activity 2

Have students research basic electric motors, such as homopolar motors, and investigate variables to hypothesize their effects on the system. Students may start using the right-hand rule (with no mathematics) to explain their observations.

Resources

- [Creating an Electromagnet](#)—lesson plan from the Teach Engineering website
- [Electromagnetism Experiment](#)—linked resource from NSTA on an NGSS-focused lesson that includes measuring currents of the system (to see the resource in detail, click “View this Resource” on the right side of the title)
- [Magnetic Field](#), [Magnetic Force](#)—Two YouTube videos about the right-hand rule from the Bozeman Science channel
- [Simple Electromagnetic Train](#)—YouTube video on a possible investigation that could be done in the classroom or could be used as a guided conversation
- [Get Your Motor Running](#)—lesson plan from the Teach Engineering website on the construction of a simple motor
- [Homopolar Motors](#) and [DIY Shake Flashlight](#)—articles by K&J Magnetics that could be used for extensions

Grade 8**Motion and Stability: Forces and Interactions**

8.PS.12 Construct an argument from evidence explaining that fields exist between objects exerting forces on each other (e.g., interactions of magnets, electrically charged strips of tape, electrically charged pith balls, gravitational pull of the moon creating tides) even when the objects are not in contact.

Connections to *A Framework for K–12 Science Education: Practices, Crosscutting Concepts, and Core Ideas*:**Focus for Scientific and Engineering Practice(s):**

- Developing and Using Models
- Engaging in Arguments from Evidence

Focus for Crosscutting Concept(s):

- Cause and Effect

Focus for Disciplinary Core Idea(s):

- Types of Interactions

Key Academic Terms:

force field, electric force, magnetic force, pith ball, induction, geomagnetic field, cause of Earth's magnetic field, cause of Earth's electric field, magnets, compass, field line, gravity

Safety Considerations

Please refer to the [Alabama State Department of Education Lab Safety Guidelines](#).

What is the difference between magnetic and electrical forces?

What type of evidence is needed to argue that forces can act on an object without contacting that object?

How can forces that interact be mapped or diagrammed?

Background

A magnetic force interacts through its magnetic field. A magnetic field is formed due to a difference between charged particles. These charged particles line up in a specific direction, which produces a measurable field that moves in predictable loops. When these fields interact with materials that also have charges, they can have an attractive force. The alignment of atoms in a material determines whether that material will respond to a magnetic field. The field around a magnet always forms a closed loop. Depending on the modeling method, a magnetic force may be shown using looping vectors, the symbols N and S, and/or + and –.

Electric fields can spread outward from a single electric charge, but magnetic fields cannot develop in this way. An electric charge is typically illustrated using discrete particles that contain a positive or negative symbol, depending on the modeling method.

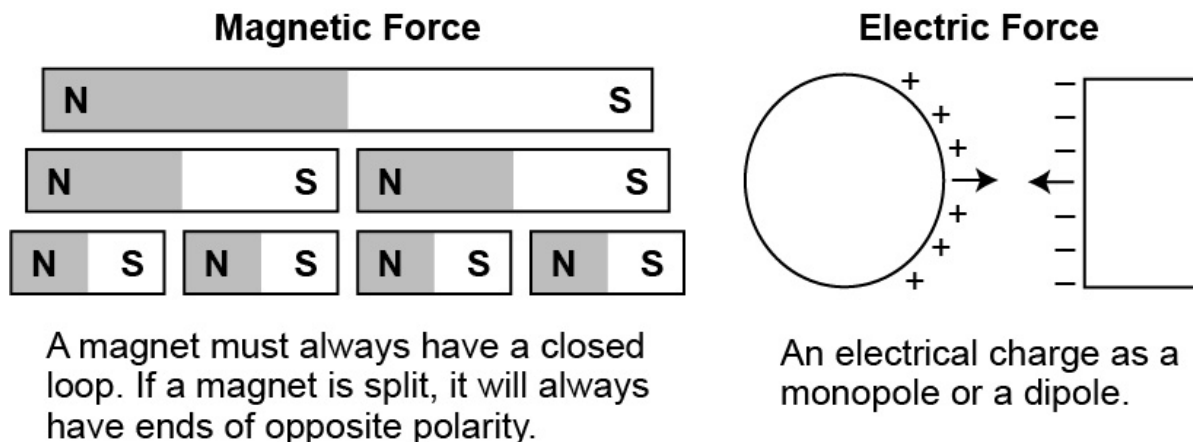

Qualitative and quantitative evidence can be gathered to demonstrate the existence of these non-contact forces. A magnetic field can be visualized using iron filings, a piece of paper, and a bar magnet. A compass interacting near a magnet can also provide evidence for the existence of a magnetic field.

Evidence for Magnetic Fields

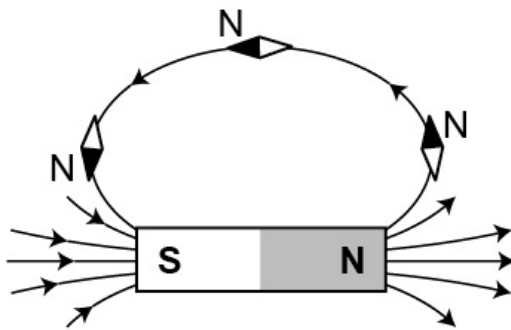

direction of compass needle
around a bar magnet

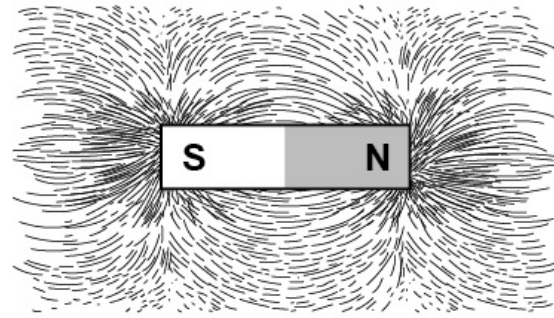

bar magnet under paper with
iron filings on top

Activities

Activity 1

Have students explore magnetic forces using magnets in the classroom. Students can create lists of objects that exhibit attractive forces and record how close they must be to a magnet for the force to become noticeable.

Activity 2

Students can research electrostatic induction and induction charging to gather evidence that non-contact forces exist.

Resources

- [The Science Behind Magnets](#)—YouTube video demonstrating a magnetic field using iron filings
- [Static Electricity Demonstrations](#)—YouTube video that can be used by an educator to create classroom investigations or demonstrations
- [World's First Electric Generator](#)—Veritasium YouTube video about magnetic fields and electrical current

How does the behavior of a magnet provide evidence that magnetic fields exist and exert a force on objects?

How can pith balls be used in an investigation of charged particles?

What happens when the distance between two charged objects changes?

How can the magnitude, or strength, of a charge affecting an object be altered?

Background

The strength of both magnetic and electrical forces depends on the quantity of material and the distance of the charges. As distance between charges decreases, the strength of attraction or repulsion increases. If the concentration of charge increases, the strength of the attractive or repulsive force also increases. The attractive and repulsive forces between two magnets can be easily observed.

Pith balls are a low-mass, conductive material suspended by strings. Pith balls can receive a charge from a material and respond, according to their charge, to items in the environment. For example, if two pith balls are given the same charge, they will repel each other. If they are provided with opposite charges, they will attract each other.

Activity

Have students test the relationship between the distance and strength of a repulsive or attractive force using different sizes of bar magnets.

1. Students should place a small bar magnet on the table.
2. Then, place a second, equal-sized bar magnet at 30 cm, 20 cm, and 10 cm distances.
3. Have students test the effects of attraction and repulsion by orienting the N and S poles of the second magnet either toward or away from the first magnet.

How can the relationship between Earth and magnets be explained?

Which forces are responsible for tides on Earth?

Background

Earth has a solid inner core and a liquid outer core that are both primarily composed of iron and nickel. The movement of the liquid outer core around the solid inner core generates Earth's magnetic field. This magnetic field can interact with magnets, like compasses, on Earth's surface.

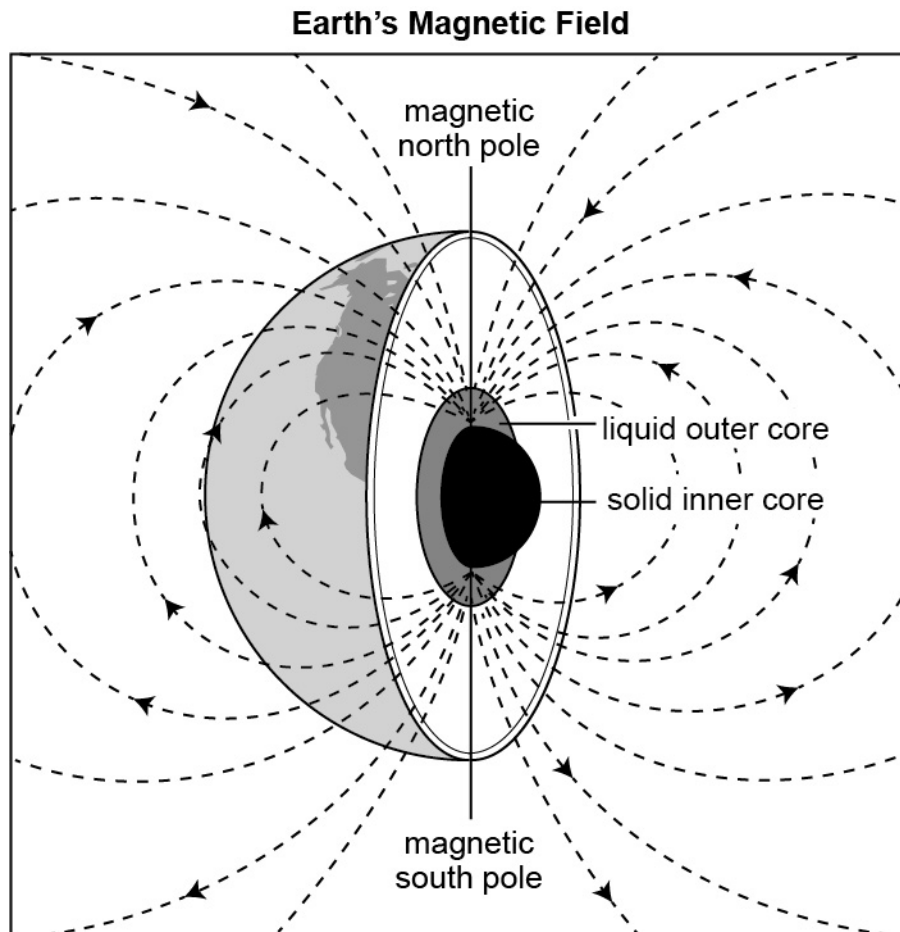

Forces of gravity from the moon and Sun affect the tides of Earth. As Earth rotates, it turns into the elongated region created by the moon's force of gravity. As the moon revolves, it eventually aligns with the Sun, and together, the Sun and moon's force of gravity increases the tidal effects on Earth.

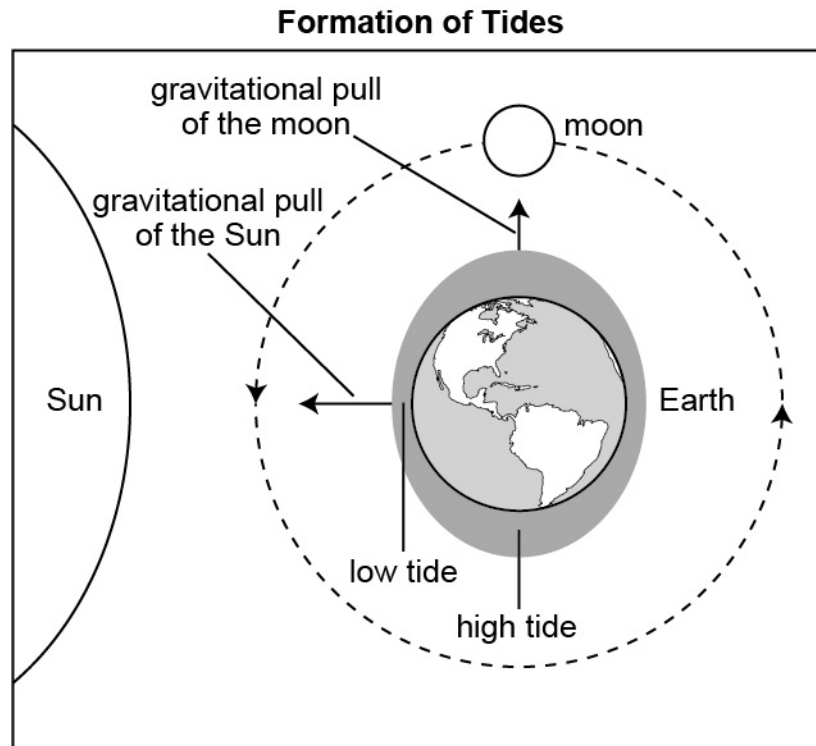

Activities

Activity 1

Have students discuss the misconception that tides “come in and out” on Earth’s surface. This misconception can be related to the “rising” and “setting” of the Sun. Humans’ limited frame of reference is the root of these misconceptions; the rotation of Earth actually causes these cycles.

Activity 2

Have students create a model to animate the tidal changes that occur on Earth. They should use a computer or draw on paper to make their models.

Resources

- [Neil deGrasse Tyson Explains the Tides](#)—YouTube video from the StarTalk Channel
NOTE: After 3:55 in the video, mild language is used by the host and guest. The educator should stop the video at 3:55 or use a tool like [TubeChop](#) to make sure the video does not play beyond that point.
- [Tidal Bulge Simulation](#)—Flash Animation (that may not work after January 2021)
- [Tides \(Physics\)](#)—animation that shows the revolution of the moon and rotation of Earth
- [Tide-O-Matic](#)—lesson plan from the Exploratorium on creating a model to demonstrate tides
- [Predicting the Tides](#)—activity from NOAA focusing on Earth’s tides

Grade 8
Energy
8.PS.13 Create and analyze graphical displays of data to illustrate the relationships of kinetic energy to the mass and speed of an object (e.g., riding a bicycle at different speeds, hitting a table tennis ball versus a golf ball, rolling similar toy cars with different masses down an incline).

Connections to *A Framework for K–12 Science Education: Practices, Crosscutting Concepts, and Core Ideas:*

Focus for Scientific and Engineering Practice(s):

- Analyzing and Interpreting Data
- Using Mathematical and Computational Thinking

Focus for Crosscutting Concept(s):

- Scale, Proportion, and Quantity
- Patterns
- Cause and Effect

Focus for Disciplinary Core Idea(s):

- Definitions of Energy

Key Academic Terms:

kinetic energy, mass, speed, graphical data, incline, distance, time, linear, exponential, direct relationship, indirect relationship, dependent variable, independent variable

Safety Considerations

Please refer to the [Alabama State Department of Education Lab Safety Guidelines](#).

What factors affect the speed of an object?

What tools are needed to determine how speed, mass, and kinetic energy are related?

How is the kinetic energy of an object affected when the mass or speed of that object is changed?

What patterns can be observed when investigating the relationship between the speed, mass, and kinetic energy of a moving object?

How would a graphical display be created to represent the relationships between speed, mass, and kinetic energy?

Background

Speed is a measurement of distance traveled over a period of time. Many factors can influence speed, such as force, mass, acceleration, and friction. Rulers, metersticks, stopwatches and scales can be used to calculate the speed and kinetic energy of an object. Kinetic energy is measured using Joules (J) as a unit and can be found using the equation below and the direct relationships in the tables:

Kinetic Energy Equation

$$\frac{1}{2}mv^2$$

Effect of Velocity and Mass on Kinetic Energy

Constant Velocity (m/s)	Increasing Mass (Kg)	Kinetic Energy (J)		Increasing Velocity (m/s)	Constant Mass (Kg)	Kinetic Energy (J)
5	70	875		5	70	875
5	140	1750		10	70	3500
5	210	2625		15	70	7000
5	280	3500		20	70	14000

Considering that all variables except one are held constant, then trends become apparent. If the mass of an object is doubled, then the kinetic energy of that object is doubled. If the velocity of an object is doubled, then the kinetic energy of that object is quadrupled. Increasing mass has a linear progression, while increasing velocity has an exponential progression.

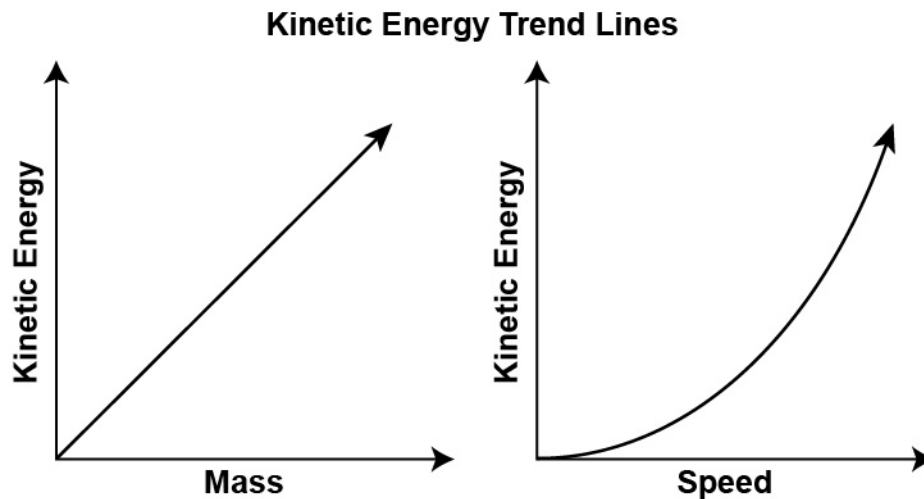

Activities

Activity 1

Have students perform an investigation using three toy cars and a simple ramp to find the amount of kinetic energy in each toy car. The height of the ramp can be adjusted so that different velocities are obtained. If possible, the ramp can be at a constant height, and weight can be added to the cars to change their mass. Objects like film canisters and washers could replace toy cars if these other objects are more readily available.

Example Data Table for Ramp Height of 10 Centimeters

Trial	Mass (Kg)	Distance (m)	Time (sec)	Velocity (m/s)	Kinetic Energy (J)
1	.030	.060			
2	.030	.060			
3	.030	.060			

Example Data Table for Ramp Height of 20 Centimeters

Trial	Mass (Kg)	Distance (m)	Time (sec)	Velocity (m/s)	Kinetic Energy (J)
1	.030	.060			
2	.030	.060			
3	.030	.060			

Activity 2

Separate students into small groups. Ask them to discuss the kinetic energy equation and to hypothesize about how each variable affects kinetic energy. Then, have each group create a “proof” that can be shared with other groups and lead to further discussion.

Resources

- [Airboat Physics](#)—guided simulation from the cK–12 Foundation that allows for the manipulation of mass and thrust and graphs the resulting acceleration
- [Energy Exchange with a Trampoline](#)—guided simulation from the cK–12 Foundation that allows for the manipulation of mass, height, and elasticity and graphs the exchanges in energy
- [Milkshake Slide](#)—guided simulation from the cK–12 Foundation that allows for the manipulation of force, mass, surface area, friction, and distance and graphs the velocity and speed

Grade 8**Energy**

8.PS.14 Use models to construct an explanation of how a system of objects may contain varying types and amounts of potential energy (e.g., observing the movement of a roller coaster cart at various inclines, changing the tension in a rubber band, varying the number of batteries connected in a series, observing a balloon with static electrical charge being brought closer to a classmate’s hair).

Connections to *A Framework for K–12 Science Education: Practices, Crosscutting Concepts, and Core Ideas:*

Focus for Scientific and Engineering Practice(s):

- Developing and Using Models
- Constructing Explanations

Focus for Crosscutting Concept(s):

- Systems and System Models
- Patterns
- Cause and Effect

Focus for Disciplinary Core Idea(s):

- Definitions of Energy
- Relationship between Energy and Forces

Key Academic Terms:

potential energy, kinetic energy, energy of position, static electricity, energy system, elastic potential energy, stored energy, electrical charge, gravity

Safety Considerations

Please refer to the [Alabama State Department of Education Lab Safety Guidelines](#).

In a system, what is the relationship between potential energy and kinetic energy?

How can a model represent the potential energy in a system when the distance between stationary objects changes?

How do the potential energy and the kinetic energy of a roller coaster cart change as the cart moves along a track?

How do different types of potential energy compare to one another?

Background

Potential energy and kinetic energy share an inverse relationship: as one increases, the other decreases. The total amount of energy in a system never changes due to the law of conservation of energy, but many transformations of energy occur. In a closed system, with no friction, there would only be a transfer of energy between potential and kinetic energy. In an open system, there are thermal transfers and sound transfers as well as transfers of potential energy and kinetic energy. All transfers, when added together, must equal the total amount of energy in the system.

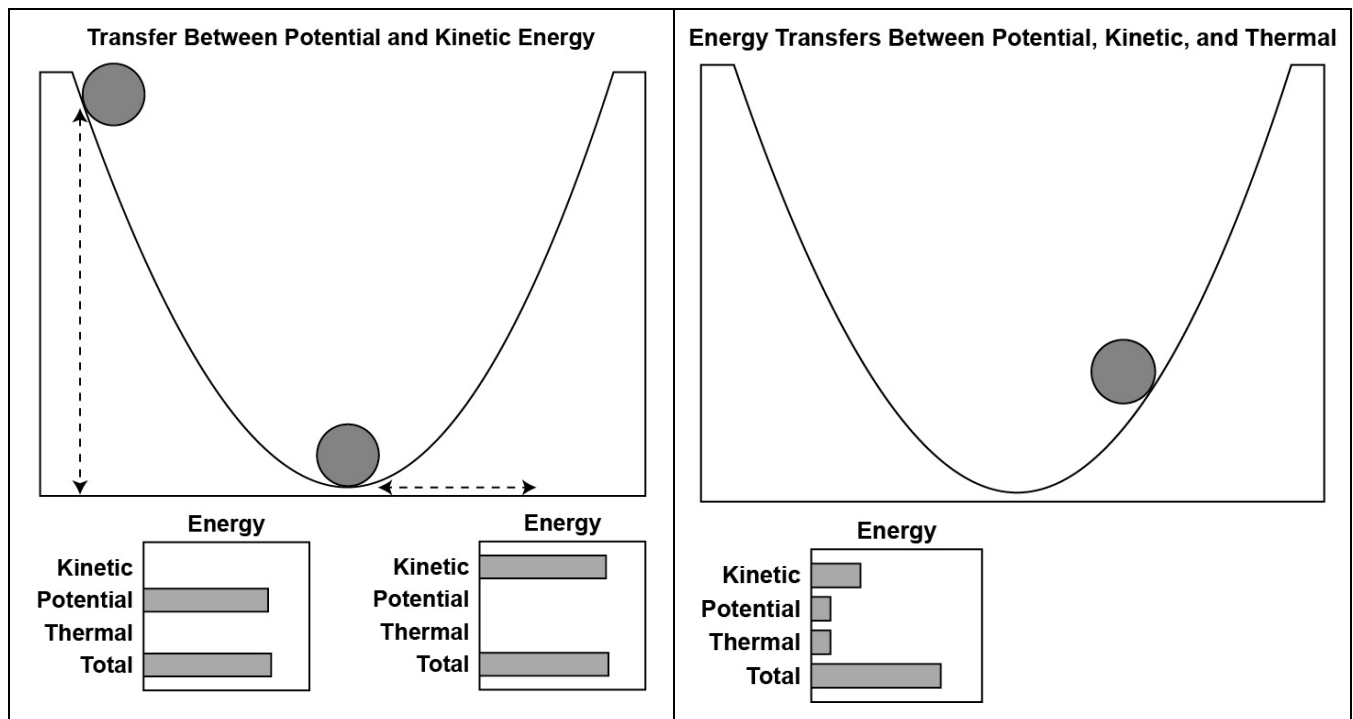

Roller coasters are typically used to illustrate the transfer of potential and kinetic energy. As the carts of a roller coaster move along their track, changes in height align with transfers of energy.

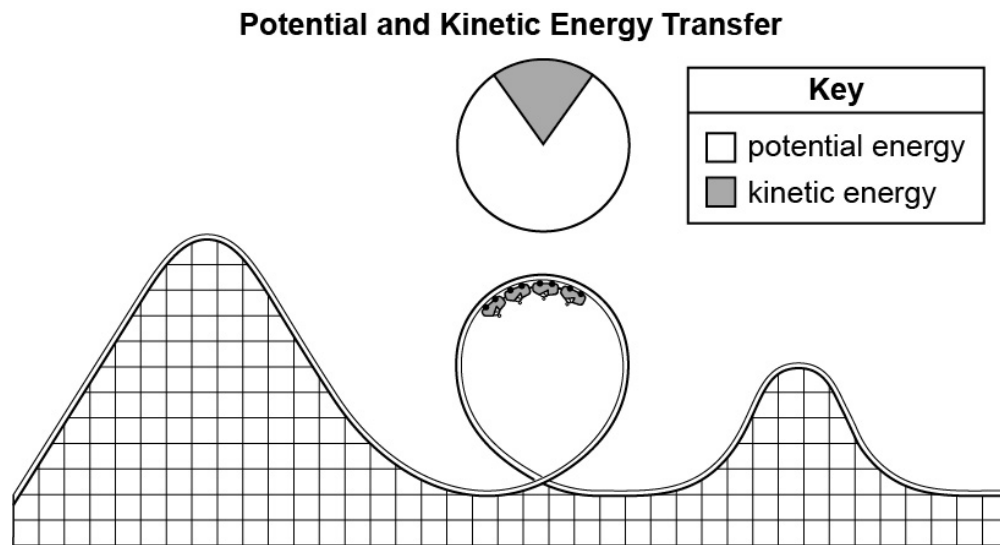

When examining the route of a roller coaster, it is important to note how the heights of each section gradually decrease. A maximum amount of potential energy exists in the system at the start of the route, and the roller coaster can never obtain that maximum value again, so each later point in the route must have a lower total amount of energy than the previous point.

Rollercoasters and skate parks show transfers of potential and kinetic energy due to changes in height, but other forms of potential energy exist as well. Potential energy can be stored when the shape of an object changes. The type of energy known as elastic potential energy is affected by changes in shape, and it can be modeled in many ways. Changes in electrical charge, as in a battery or static electricity, are also forms of potential energy and are covered in more detail in the next section.

Activities

Activity 1

Have students build and test a model roller coaster using foam pipe insulation. Objectives and variables can be determined by the educator to have this hands-on experience be inquiry-based or a more directed investigation.

Activity 2

Have students work through various simulations to study the relationship between potential and kinetic energy transfers. As a closing exercise, discuss the limitations of the simulations.

Resources

- [PhET Energy Skate Park](#)—simulation from PhET
- [Energy in a Roller Coaster Ride](#)—interactive animation from PBS LearningMedia
- [Building Roller Coasters](#)—lesson plan from Teach Engineering that includes materials list and worksheets

How can the potential energy of a rubber band be changed?

How does static electricity affect objects with an electrical charge?

How does an increasing distance affect a static charge?

How do batteries affect the energy of an electrical system?

Background

Elastic potential energy changes as the shape of an object changes. Rubber bands and springs are good models to illustrate the concept of elastic potential energy. As a rubber band is stretched, its potential energy increases, and as it returns to its natural shape, its potential energy decreases.

Static electricity occurs when there is an imbalance of charge on an object. The most common type of static electricity is formed when two objects are in contact with each other. A balloon, when rubbed on hair, creates an induced separation of charges. The balloon gathers an excess of negative charges while the strands of hair acquire excess positive charges. When placed together, these items stick due to their attractive qualities. When the balloon and hair are separated, strands of hair may repel each other due to their like charges and the balloon may stick to other surfaces. Once an object has gained a static charge, it will naturally want to return to a neutral state. To do this, the excess charge must discharge to another object or the surrounding environment. Walking across a carpet, a person can build up a static charge, and then when a person touches a conductor, like a doorknob, it allows the excess charge to be released. As the distance between electrical charges is reduced, the strength of attraction increases. This relationship accounts for why a finger must be in close contact with an object for the static release to occur.

Batteries store electrical charge in the form of chemical energy. When a circuit is made that connects the terminals of the battery, charge can flow, and then energy is converted to electrical and thermal energy. Larger batteries will generally have greater potential than smaller batteries. How long a battery lasts depends on the device it is connected to and the strength of the electrical current. If batteries are connected in a series, the potential voltage of the system increases. If batteries are connected in parallel, the potential current of the system increases.

Activities

Activity 1

Have students use rubber bands to identify changes in potential and kinetic energy. Students' observations can be simple and informal, or their observations can be more directed by the educator through specific investigations.

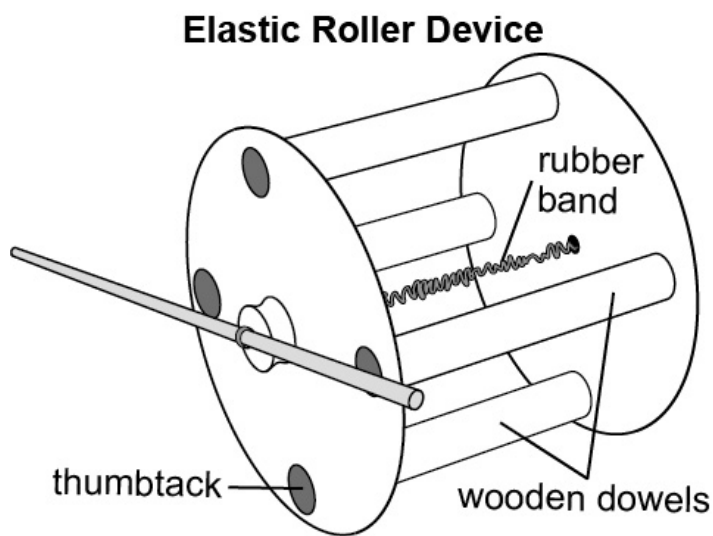

Activity 2

Have students create or investigate models that show static induction and discharge. If digital resources are available, have students use simulations. If digital resources are not available and school rules allow, have students interact with various materials known to create static charges. Then, have students illustrate the charges of these objects through drawings or written explanations.

Resources

- [Balloons and Static Electricity](#)—PhET simulation for static induction
- [John Travoltage](#)—PhET simulation for static discharge
- [Hooke's Law](#)—PhET simulation that can illustrate elastic potential energy with springs
- [Circuit Construction Kit](#)—PhET simulation that can illustrate energy in batteries
- [Elastic Band Rollers](#)—lesson from the STEM Learning Foundation (in the UK) that includes directions, a materials list, and a worksheet

Grade 8
Energy
8.PS.15 Analyze and interpret data from experiments to determine how various factors affect energy transfer as measured by temperature (e.g., comparing final water temperatures after different masses of ice melt in the same volume of water with the same initial temperature, observing the temperature change of samples of different materials with the same mass and the same material with different masses when adding a specific amount of energy).

Connections to *A Framework for K–12 Science Education: Practices, Crosscutting Concepts, and Core Ideas:*

Focus for Scientific and Engineering Practice(s):

- Analyzing and Interpreting Data
- Constructing Explanations

Focus for Crosscutting Concept(s):

- Scale, Proportion, and Quantity
- Cause and Effect

Focus for Disciplinary Core Idea(s):

- Definitions of Energy
- Conservation of Energy and Energy Transfer

Key Academic Terms:

thermal energy, conductor, insulator, energy transfer (heat), temperature, specific heat (heat capacity), kinetic energy, system, surroundings, conduction, convection, radiation

Safety Considerations

Please refer to the [Alabama State Department of Education Lab Safety Guidelines](#).

How is temperature related to energy?

How can thermal energy and heat be compared?

What tools are used to measure thermal energy transfer?

Background

Temperature is a method of measuring the amount of energy in a system or object. The measurement of temperature is the average amount of kinetic energy in the molecules being observed.

Thermal energy and heat are related, but these two terms are not synonymous. Thermal energy refers to the amount of energy in an item or system and is based on the amount of matter. Heat is the transfer of thermal energy and moves from areas high in temperature to areas that are lower in temperature.

Thermometers are commonly used to measure the transfer of thermal energy. A thermometer provides a consistent reference point using degrees Celsius, which can be converted into Joules if needed. Joules are an official SI unit and are a measurement of the amount of energy needed to perform work.

Activities

Activity 1

Have students find the freezing, melting, and boiling points of different materials. Water and steric acid are two common materials that provide reliable data.

Activity 2

After students have received instruction on these topics, have them create a pamphlet, storybook, or a digital form of media that explains the differences between thermal energy and heat to a new audience.

Resource

- [Heat, Temperature, and Thermal Energy](#)—YouTube video with student explanations

What is the role of particle motion in the transfer of thermal energy from one material to another?

Given experimental findings, how can students determine whether a material is a conductor or an insulator?

How do the temperatures of different materials of equal mass change when a specific amount of thermal energy is added?

How can students use results from an investigation to determine a material's capacity to transfer energy?

Background

As particles move, collisions occur that transfer energy. As the rate of collisions increase, the transfer of heat increases. Eventually, a state of equilibrium will be reached where the object receiving the transferred energy will have the same temperature as the heat source.

Measurements of temperature can be used to quantitatively assess thermal conductive or resistive qualities. Quantitative data showing a change in temperature would represent a conductor, while no change in temperature would represent an insulator. For example, if a wooden dowel and a metal rod are both placed into warm water, a student or educator could touch them for qualitative results or measure their surface temperatures.

When two identical samples of matter of different masses are exposed to identical amounts of heat, the transfer of energy will occur at different rates. To cause the two materials to exhibit similar temperature changes, a larger amount of energy would be needed to raise the temperature of the material with the larger mass at the same rate as the other material.

Activities

Activity 1

Have students create a flip-book, stop-motion video, or another type of media that shows a particle model of energy transfer.

Activity 2

Students can perform various investigations to study the rates of heat transfer and specific heat. Investigations can be done using common items like metal, water, and foam cups. Students should pay close attention to the setup of these investigations and reflect on their limitations if they do not obtain the expected results.

The setup below shows how heat transfer could be investigated using various types of metals.

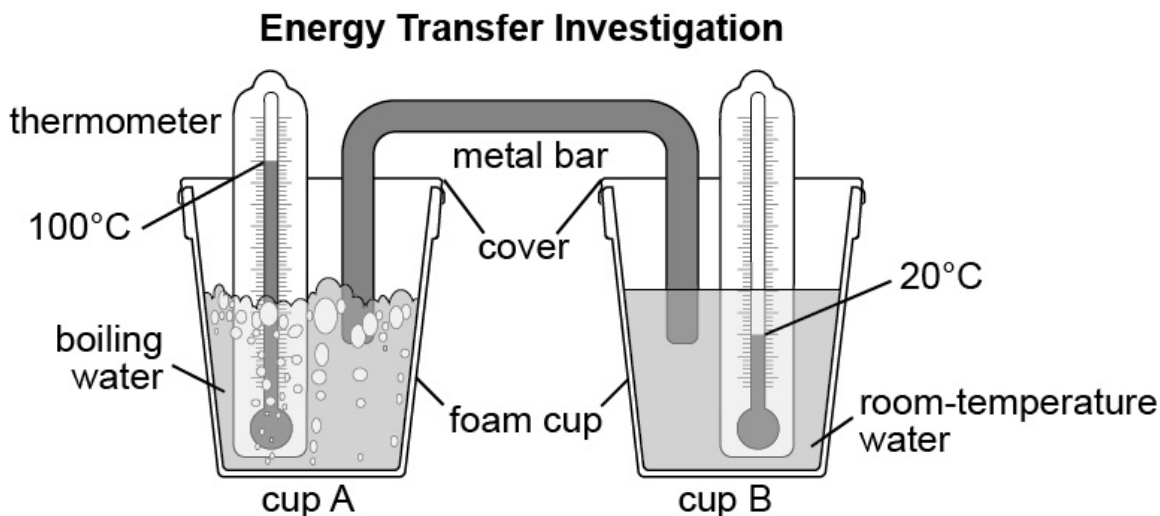

The setup below is a basic calorimeter that can be used with metals of different sizes to find specific heat. Students could be given unknown metal samples to investigate and then compare their results to a table that contains known specific heats of different metals.

Specific Heat Investigation

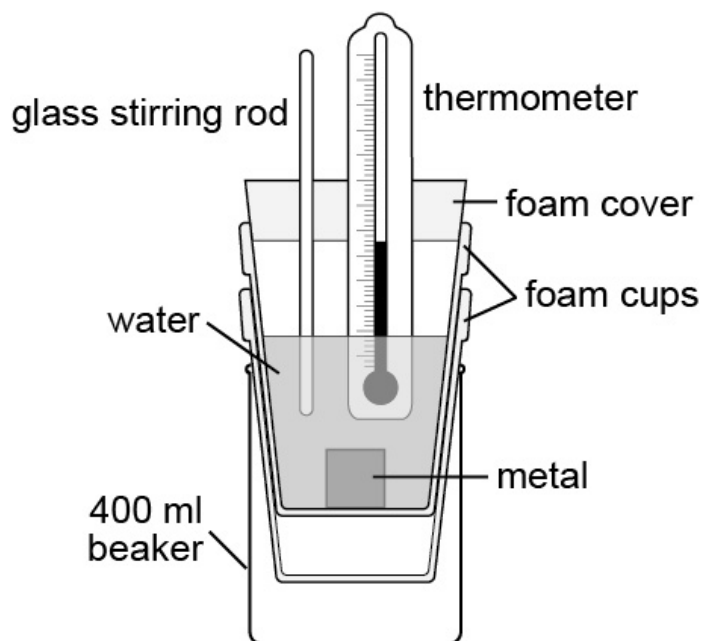

Resources

- [Conductors](#) and [Insulators](#)—animations that show different rates of energy transfer
- [Heat Capacity and Specific Heat](#)—YouTube video that explains the difference between these two concepts
- [Thermal Conductors and Insulators](#)—YouTube video that explains these concepts
- [Heat, Temperature, and Conduction Lesson](#)—lab with materials and worksheets provided by the American Chemical Society

Grade 8
Energy
8.PS.16 Apply the law of conservation of energy to develop arguments supporting the claim that when the kinetic energy of an object changes, energy is transferred to or from the object (e.g., bowling ball hitting pins, brakes being applied to a car).

Connections to *A Framework for K–12 Science Education: Practices, Crosscutting Concepts, and Core Ideas:*

Focus for Scientific and Engineering Practice(s):

- Engaging in Arguments from Evidence

Focus for Crosscutting Concept(s):

- Energy and Matter
- Cause and Effect

Focus for Disciplinary Core Idea(s):

- Conservation of Energy and Energy Transfer

Key Academic Terms:

kinetic energy, transfer of kinetic energy, claim, argument, conservation of energy, thermal energy, potential energy, sound energy

Safety Considerations

Please refer to the [Alabama State Department of Education Lab Safety Guidelines](#).

What is the law of conservation of energy?

What two factors are conserved when objects interact?

What is kinetic energy, and how can the kinetic energy of a substance change?

What evidence supports the claim that when the kinetic energy of an object changes, energy enters or leaves a system?

Background

The law of conservation of energy states that energy cannot be created or destroyed, but instead, energy is transferred from one form to another. When objects collide with each other, there are two types of collisions that occur, elastic and inelastic collisions. In an elastic collision, momentum and kinetic energy are perfectly conserved. Contrary to this, inelastic collisions transfer some kinetic energy into another form while momentum is conserved.

Kinetic energy is the energy of movement and is dependent on the velocity and mass of the object in motion. If an object's speed or mass changes, its kinetic energy changes as well.

Kinetic Energy Equation

$$\frac{1}{2}mv^2$$

A change in speed means that energy has either entered or left the system being observed. Such an energy transfer can be observed as a change in temperature, a change in shape, or a change in the production of sound or light.

Activities and Consideration

Activity 1

Have students visualize the kinetic energy of water at different temperatures using food coloring. The educator should provide students with refrigerated water, room-temperature water, and hot water. Then, students should place one or two drops of food coloring in each type of water and observe the varying rates of diffusion due to the movement of water.

Activity 2

The educator should obtain two large metal spheres and strike them together with a piece of paper between them. The spheres will produce a loud sound and scorch small areas of the paper where the collision took place.

Consideration

Elastic collisions in real life are not perfect. For simplicity, most collisions can be treated as elastic collisions.

Resources

- [Elastic and Inelastic Collisions](#)—YouTube video from the Bozeman Science channel
- [Bowling Ball Collision](#)—YouTube video that shows elastic collisions

Grade 8**Waves and Their Applications in Technologies for Information Transfer**

8.PS.17 Create and manipulate a model of a simple wave to predict and describe the relationships between wave properties (e.g., frequency, amplitude, and wavelength) and energy.

a. Analyze and interpret data to illustrate an electromagnetic spectrum.

Connections to *A Framework for K–12 Science Education: Practices, Crosscutting Concepts, and Core Ideas*:**Focus for Scientific and Engineering Practice(s):**

- Developing and Using Models
- Analyzing and Interpreting Data
- Using Mathematics and Computational Thinking

Focus for Crosscutting Concept(s):

- Patterns

Focus for Disciplinary Core Idea(s):

- Wave Properties

Key Academic Terms:

wave, wavelength, frequency, energy, amplitude, electromagnetic spectrum, visible light spectrum, mechanical wave, electromagnetic wave, medium, vacuum, pitch, volume, light intensity

Safety Considerations

Please refer to the [Alabama State Department of Education Lab Safety Guidelines](#).

What are waves, and how can they be categorized?

How can wave properties (frequency, amplitude, and wavelength) be compared in terms of energy?

How can a model be manipulated to predict or describe wave properties?

Background

Waves can be categorized based on their ability to transfer energy with or without the presence of matter. A mechanical wave requires matter to be present for a transfer of energy to occur, while an electromagnetic wave can transfer energy through a vacuum without the presence of matter.

When modeling waves, a wave can be shown as a transverse with the characteristics of amplitude, wavelength, and frequency. The amplitude of a mechanical wave is related to the amount of energy transported. High amplitudes correlate with high levels of energy. There is a directly proportional relationship between the amplitude of a wave and the energy that is transferred. Wavelength and frequency are related to each other as well. Frequency is the number of waves that pass a point in a certain amount of time, and wavelength is the distance between crests in a wave. Shorter wavelengths have higher frequencies and carry more energy.

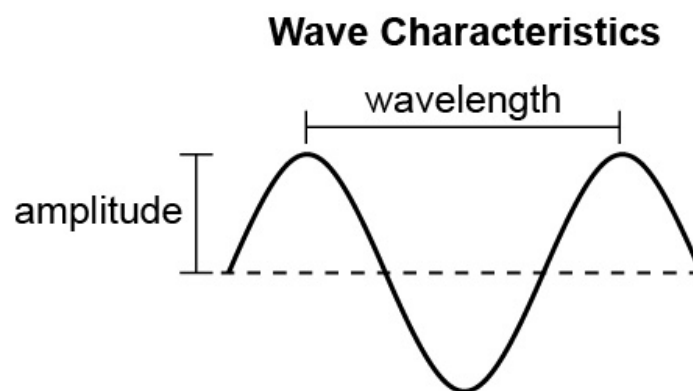

Physical or illustrated models can manipulate factors like amplitude, wavelength, frequency, and medium so that students can observe their effects on a wave.

Activities

Activity 1

Have students use ropes or spring toys to model waves and practice vocabulary. Students should change the energy input of their model and observe how wave characteristics change. Different types of rope or tension on a rope will also perform differently and give perspective on transitions to different media.

Activity 2

Use a bell jar to demonstrate that mechanical waves require a medium to transfer energy and electromagnetic waves do not.

Resources

- [Loss of Sound in a Vacuum](#)—YouTube video that demonstrates that mechanical waves require a medium
- [Wave Simulation](#)—PhET simulation and lesson plans for wave characteristics

How is energy transferred in the electromagnetic spectrum?

How can waves in the electromagnetic spectrum be modeled to show the relationship between wave properties?

What are the characteristics (frequency, wavelength, and energy) of the colors within the visible light spectrum?

Background

Electromagnetic waves propagate and transfer energy through oscillations of electric and magnetic fields. Electromagnetic waves are part of a spectrum and are categorized by wavelength. As the wavelength of an electromagnetic wave decreases, the energy transferred by the wave increases. Within the electromagnetic spectrum, there is a thin band known as visible light. Waves in this band have wavelengths between 400 nanometers and 750 nanometers. The amplitude of visible light can be equated to intensity. Low-amplitude visible light appears dim, while high-amplitude visible light appears bright. Longer wavelengths of visible light appear red, while shorter wavelengths appear blue or violet.

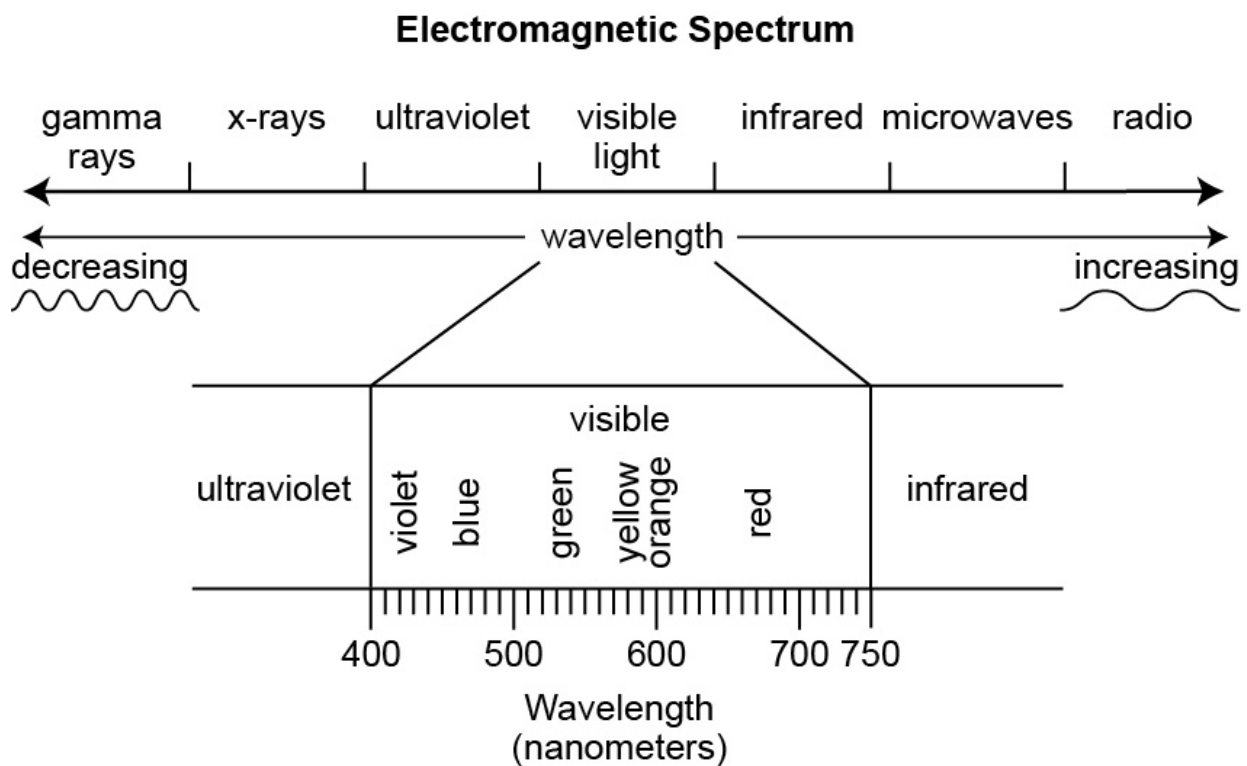

Activity and Consideration

Activity

First, have students research Isaac Newton and his studies of visible light. Then, have students research emission and absorption spectrums to see how light can provide data on the matter contained in stars. Students should learn about relationships such as temperature and color that are similar to the relationship between wavelength and energy.

Consideration

Light waves can be modeled using a transverse wave, along with lines or dots that represent particles. Depending on the concept being presented to students, the educator may use different models of light waves.

Resources

- [Blue LEDs Win the Nobel Prize](#)—article from NOVA
- [PhET Color Simulation](#)—model of light as a beam or particles
- [PhET Wave Interference Simulation](#)—model of light as a wave
- [Visible Light Frequencies Lab](#)—lab activity from the Material Research Lab (see page 3 of the PDF)
- [Tour of the Electromagnetic Spectrum](#)—article from NASA (with graphics and video)

Grade 8
Waves and Their Applications in Technologies for Information Transfer
8.PS.18 Use models to demonstrate how light and sound waves differ in how they are absorbed, reflected, and transmitted through different types of media.

Connections to *A Framework for K–12 Science Education: Practices, Crosscutting Concepts, and Core Ideas:*

Focus for Scientific and Engineering Practice(s):

- Developing and Using Models
- Analyzing and Interpreting Data

Focus for Crosscutting Concept(s):

- Structure and Function
- Cause and Effect
- Patterns

Focus for Disciplinary Core Idea(s):

- Wave Properties
- Electromagnetic Radiation

Key Academic Terms:

light wave, reflection, refraction, absorption, light transmission, sound insulation, concave lens, convex lens, medium, vacuum, sound wave, mirror, lens, wave property, mechanical wave, electromagnetic wave, opaque, translucent, transparent

Safety Considerations

Please refer to the [Alabama State Department of Education Lab Safety Guidelines](#).

How can students model the differences between light waves and sound waves (matter waves)?

How can the path by which light travels be modeled and described (reflection, absorption, and transmission)?

How can models be used to represent lenses (concave and convex) and mirrors that alter light waves?

Background

Sound waves require a medium to propagate because they are compression waves that rely on matter. A light wave is a fluctuation of electric and magnetic fields and can move through empty space, like a vacuum. Sound waves can be characterized by changes in amplitude and wavelength that result in different volumes (amplitude) and pitches (wavelength).

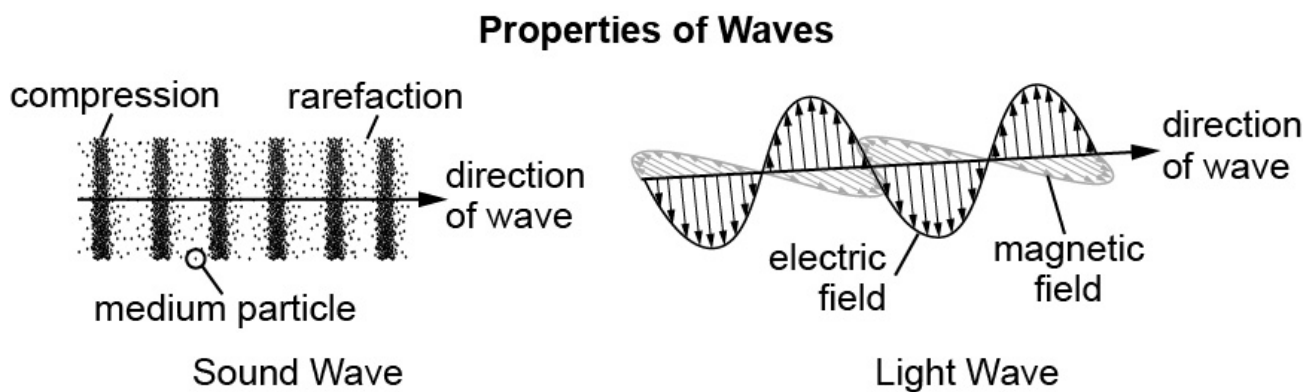

When modeling a light wave using a drawing, a single line can be used to represent the pathway. When light strikes an object, it may reflect, transmit, or be absorbed, depending on the characteristics of the light and the medium.

Reflection of light occurs at the same angle of incidence as the medium of interaction. This means that light reflects off an object at the same angle it strikes the object.

Transmittance occurs when light passes through a medium. As light passes through, it can be refracted or scattered, depending on the characteristics of both the light and the medium. Refraction occurs when the pathway of light is bent due to changes in speed; refraction can be modeled using Snell's law. Scattering occurs when light is re-emitted after being absorbed. However, scattering does not occur according to the angle of incidence.

Absorption of light occurs when light energy is converted into another form of energy. This conversion typically results in heat energy, and when modeled in a drawing, absorbed light has a pathway that disappears.

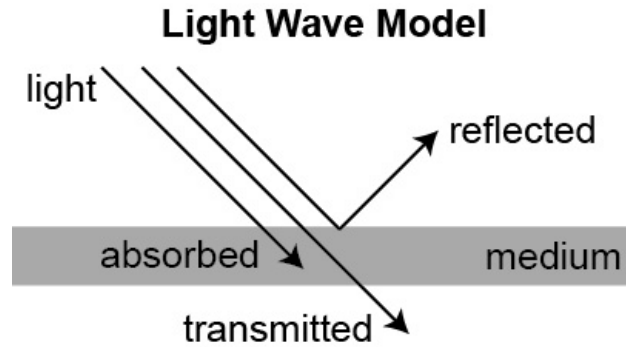

When light passes through a lens, the intersection of the light rays is known as the focal point. With a convex lens, a real image is produced by converging rays, but the image is inverted. When light passes through a concave lens, a smaller virtual image is produced by diverging rays, and the image is upright. Adjusting the focal length of either type of lens will change the image perceived by the viewer.

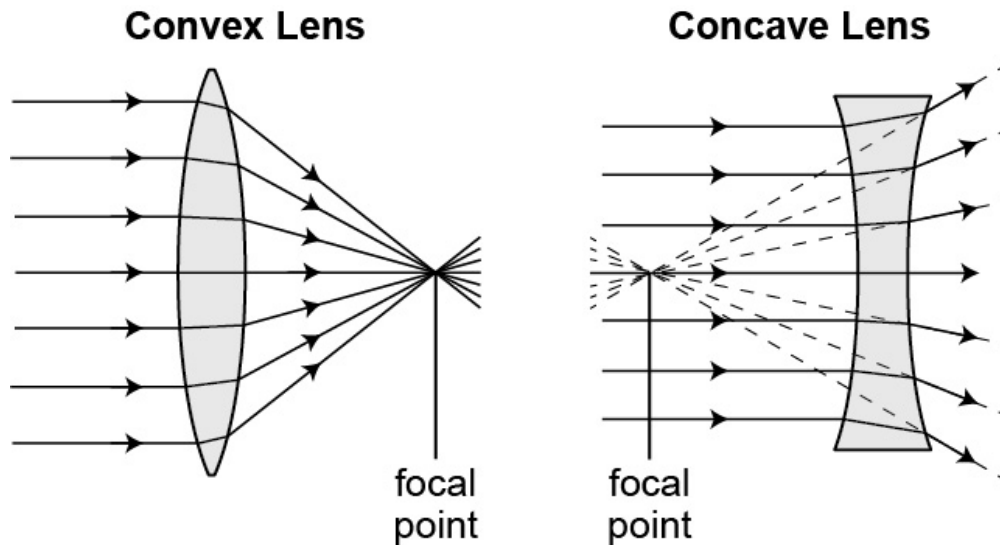

Mirrors reflect light at a proportionate angle according to the law of reflection.

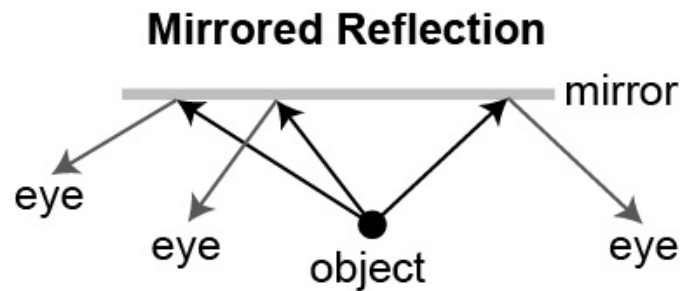

Activities

Activity 1

Have students use water to model the properties of a wave. After filling the bottom of a shallow baking pan with water, students should place different materials one at a time in the center of the pan. With each material, students should carefully use an eyedropper to disturb the water on one side of the pan and then observe how the resulting waves interact with the material in the center of the pan, as shown below.

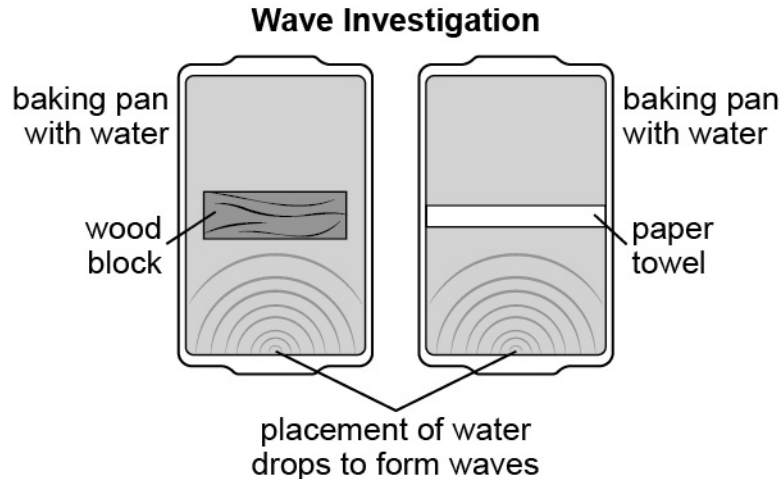

Activity 2

Have students use various lenses and mirrors to investigate the relationship between focal length and the type of image produced by a lens or combination of lenses. If physical lenses are not available, simulations, such as those from the “Resources” section below, can be used and achieve the same result.

Resources

- [All about Light](#)—high-level resource from Fermilab
- [Electromagnetic Wave Penetration](#)—analogy and accurate explanation provided by a graduate student at Fermilab
- [Reflection, Transmission, and Absorption](#)—lesson from the WISELearn OER website
- [Gummy Bear Demonstration](#)—YouTube video from the Bozeman Science channel
- [Focal Lengths](#) and [Images](#)—investigations with materials lists and directions from the Optics4kids website
- [Light Simulations](#)—PhET simulation resource
- [Optics Simulation](#)—open-source simulation hosted on Github
- [oPhysics Simulations](#)—simulation resource created by retired teacher Tom Walsh

How could a model based on data show a sound wave changing as it passes through various media?

Given data, how can students make arguments about which properties of a material are best suited for sound insulation?

Background

The speed of a sound wave varies depending on the medium it passes through. Sound waves move faster when particles of matter are closer together. This means that sound moves fastest through solid materials and slowest through gases.

Material	Speed of Sound (m/s)
Copper	4,600
Water	1,481
Air	343

Changing the surface of materials also affects the reflection and absorption of sound. Soft materials, such as foam, can absorb large amounts of the energy of sound waves and reduce vibrations from sound. Hard materials, such as cement, reflect large amounts of the energy of sound waves, rather than absorbing the energy. Soundproofing and sound-dampening materials often use the qualities of reflection and absorption together to reduce the amplitude and energy of sound waves.

Sound amplitude can be measured using decibels (dB). To give a sense of perspective about the decibel as a unit, a normal conversation occurs at around 60 dB, and an ambulance siren creates sounds of around 120 dB. For investigations of sound dampening, qualitative data can be collected based on perceived amplitude, or a decibel meter device or application can be used to collect quantitative data.

Common Household Sounds and Their Decibel Ratings

Item	Decibel Rating (dB)
Dishwasher	70
Toilet flush	75
Doorbell	80
Vacuum cleaner	85
Hair dryer	95
Crying baby	110

Activity

Have students attempt to construct devices that amplify or dampen sound. Constraints may include the size and placement of the devices during testing. Students can reflect on situations where either amplification or dampening of sound would be beneficial.

Resources

- [Sound Dampening](#)—YouTube video with good information (from 0:57 to 3:16)
- [Soundproofing](#)—article with graphics
- [Anechoic Room](#)—YouTube video from Veritasium’s Channel

Grade 8**Waves and Their Applications in Technologies for Information Transfer**

8.PS.19 Integrate qualitative information to explain that common communication devices (e.g., cellular telephones, radios, remote controls, Wi-Fi components, global positioning systems [GPS], wireless technology components) use electromagnetic waves to encode and transmit information.

Connections to *A Framework for K–12 Science Education: Practices, Crosscutting Concepts, and Core Ideas*:**Focus for Scientific and Engineering Practice(s):**

- Constructing Explanations and Designing Solutions
- Obtaining, Evaluating, and Communicating Information

Focus for Crosscutting Concept(s):

- Structure and Function

Focus for Disciplinary Core Idea(s):

- Information Technologies and Instrumentation

Key Academic Terms:

analog transmission, digital transmission, electromagnetic wave, binary code, encode, digital signal, signal

Safety Considerations

Please refer to the [Alabama State Department of Education Lab Safety Guidelines](#).

What is an electromagnetic wave?

How are electromagnetic waves (digital information) coded for communication?

What types of signals are carried by electromagnetic waves?

What types of information or data would allow a student to claim that some common communication devices use electromagnetic waves?

Background

Electromagnetic waves are produced due to fluctuations in magnetic and electrical fields. The changes occur at different frequencies, which make up the electromagnetic spectrum.

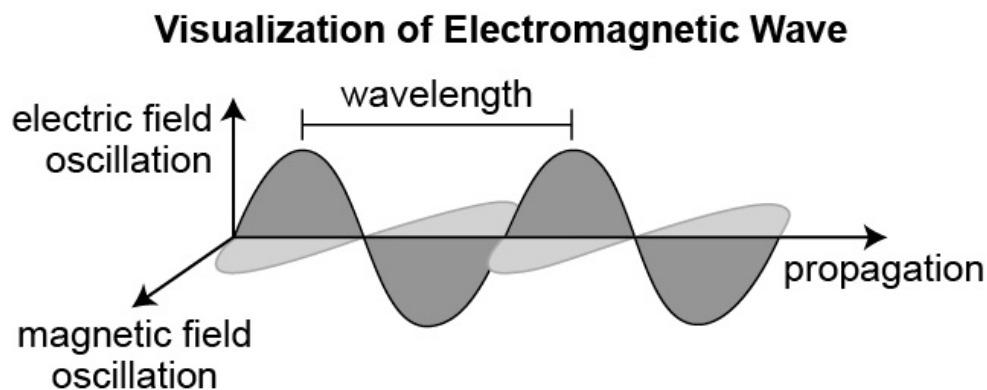

An electromagnetic wave can carry both analog and digital signals. Any wireless devices that students handle use electromagnetic waves to send and receive information. Qualitative data, such as causes and effects, can be observed using such devices. Tools such as compasses, oscilloscopes, Wi-Fi strength analyzers, and EMF meters can also be used to detect and gather data on electromagnetic waves.

Activity

Have students research what types of electromagnetic waves various devices use to communicate.

Resources

- [Explanation of Electromagnetic Waves](#)—YouTube video by Physics Girl (start at 1:00)
- [DIY EMF Detector](#)—instructions and materials from the Hackaday website
- [Arduino EMF Detector](#)—instructions, materials, and code from the Makezine website
- [FCC Information on EM Spectrum](#)—possible research source for students and educators

How can the difference between a digital signal and an analog signal be described?

Which type of signal weakens over distance?

What are the advantages of a digitized signal?

What features make digital transmission signals more reliable than analog transmission signals?

What does it mean to “encode” digital information?

What is a binary code system?

How is information stored and accessed by computers?

Background

An analog signal is continuous, while a digital signal is discrete. This means that analog has a potentially infinite number of values, while digital signals use distinct values.

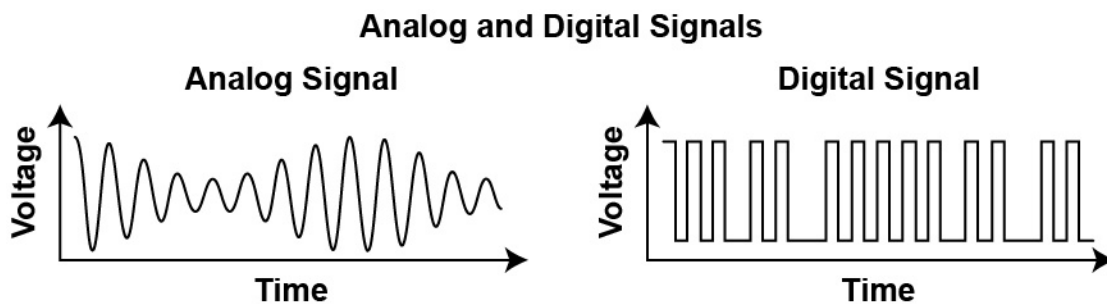

Analog signals lose amplitude over time and become distorted by interactions with other forms of electromagnetic waves and energy. When an analog signal is received, it must be amplified, and this process reduces the quality of the signal. Digital signals are not diminished because they are not continuous. Although they can be affected by the interaction of other forms of electromagnetic waves, digital signals are easier to restore.

Effects of Distortion on Signals

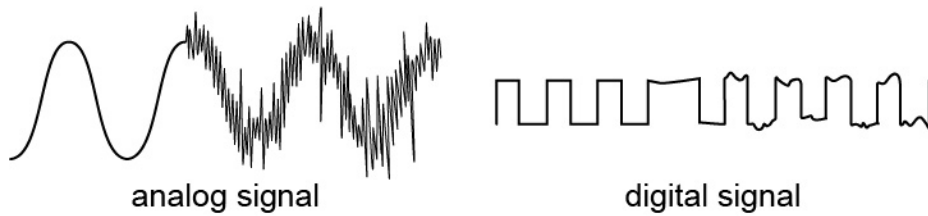

Analog signals are encoded and converted to digital signals using discrete changes in voltage. Analog signals can be related to a binary system. In the binary system, a 1 means that voltage is being passed along and a 0 means that there is no voltage present. To produce discrete digital signals, analog waves must be sampled. A sample sets the range in which data is captured and stored in the conversion process, as shown below.

Sampling of an Analog Signal

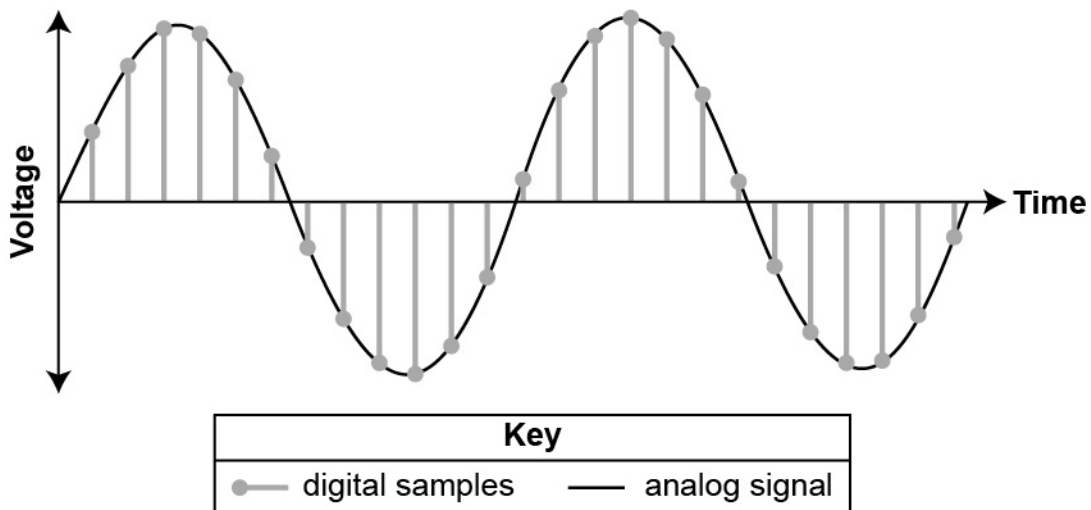

Higher sampling rates provide better quality when the digital signal is converted back to an analog signal. The range (depth) at which a digital signal is made can also affect the quality of a sample.

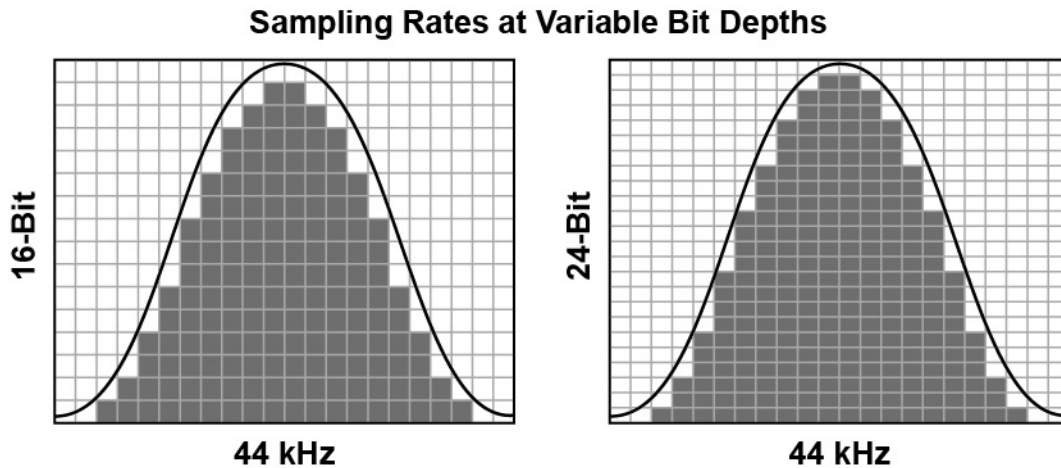

As shown above, audio CDs have a sample rate of 44 kHz and a bit depth of 16, while DVDs and Blu-ray discs have the same sample rate (44 kHz) but a bit depth of 24.

Computers use series of abstractions to read, write, and display information. Encoding general information on a computer is different from encoding an analog signal and converting it to a digital signal. Computer information is encoded and written to a specific location on a storage device and can be accessed later by a user. The lower levels of computing language use a binary system for their main functions.

Activity

Have students research the transition of American television from analog broadcast to digital broadcast and look for specific information on the following topics:

1. Major reasons for the switch
2. Benefits of the switch
3. Negatives results of the switch

Students should then decide whether they think this was a beneficial transition overall, and each student should support their viewpoint with multiple pieces of evidence.

Resources

- [Analog vs. Digital Signals](#)—BBC video comparing the sound of vinyl records to the sound of compact discs
- [Clock Analogy for Digital Signals](#)—YouTube video by AddOhms
- [Conversion of Analog to Digital](#)—YouTube video that explains and shows advantages of digital signals
- [Online Oscilloscope](#)—tool for visualizing sound input
- [Spectrum Analyzer](#)—tool for visualizing sound frequency
- [Can You Hear the Difference?](#)—quiz from NPR on digital audio quality (quality of classroom speakers makes a difference with this resource)
- [Digital Television](#)—FCC-archived website
- [Transcript of Senate Hearing](#)—official statements representing different viewpoints on the transition to digital television formats (from 2005)
- [Transcript of Senate Hearing](#)—official statements representing different viewpoints on the transition to digital television formats (from 2007)
- [Bungled Digital Transition](#)—opinion piece from WIRED Magazine (from 2009)
- [Rights Violations](#)—opinion piece from the Electronic Frontier Foundation (EFF) (from 2002)
- [Broadcast Flag Mandate 1](#)— EFF-authored accounts of issues related to encrypted media transmissions for digital television (from 2009)
- [Broadcast Flag Mandate 2](#)— EFF-authored accounts of issues related to encrypted media transmissions for digital television (from 2009)

Copyright © 2020 by the Alabama State Department of Education. The materials contained in this publication may be duplicated by Alabama educators for local classroom use. This permission does not extend to the duplication of materials for commercial use.

Alabama Educator Instructional Supports: ACAP Summative Survey

Please take a few minutes to answer 10 survey questions by April 30, 2021. You may complete the survey electronically here: <https://www.surveymonkey.com/r/WXZWXCT>. If you prefer to mail in your survey, you may print this page and mail it in an envelope using the address on the next page. You may also print this double-sided with the following page, fold it into thirds, seal it with tape, and mail it. The survey takes approximately five minutes to complete.

1. Which content area(s) did you use? (Check all that apply.)

- English Language Arts Mathematics Science

2. Which grade(s) did you use? (Check all that apply.)

- 2 3 4 5 6 7 8

3. In which state district (such as Leeds City or Winston County) do you work? _____

4. What is your current position/job title?

- Classroom teacher
- Curriculum coach/specialist (school or district)
- Teacher assistant/classroom aide/paraprofessional
- Administrator
- Other (please specify): _____

5. For how many standards did you use the material in the Instructional Supports when planning your instruction?

- All Most Some None

6. How helpful were the Instructional Supports in providing a deeper understanding of the standards?

- Very helpful Helpful Somewhat helpful Not helpful

7. How helpful were these documents to you when planning instruction?

- Very helpful Helpful Somewhat helpful Not helpful

8. How many times did you consult the Instructional Supports documents while planning instruction?

- Daily A few times a week A few times a month A few times during the school year One or two times Zero times

9. How likely are you to recommend the use of the Instructional Supports to other teachers in your district or school?

- Very likely Somewhat likely Somewhat unlikely Very unlikely

10. Is there any additional information about the Instructional Supports that you would like to share or any additional resources that you would like to see included?

Thank you for taking the time to fill out the survey.

(fold here)

Place stamp
here. Postal
service will not
accept without
a stamp.

Data Recognition Corporation
Attn: Alabama Instructional Supports Feedback
2800 Northwest Boulevard
Plymouth, MN 55441

(fold here)