



SUMMATIVE

Grade 6 Science

Alabama Educator Instructional Supports

Alabama Course of Study Standards

Introduction

The *Alabama Instructional Supports: Science* is a companion to the 2015 *Alabama Course of Study: Science*. Instructional supports are foundational tools that educators may use to help students become independent learners as they build toward mastery of the *Alabama Course of Study* content standards. **Instructional supports are designed to help educators engage their students in exploring, explaining, and expanding their understanding of the content standards.**

The content standards contained within the course of study may be accessed on the Alabama State Department of Education (ALSDE) website at www.alsde.edu. When examining these instructional supports, educators are reminded that content standards indicate minimum content—what all students should know and be able to do by the end of each grade level or course. Local school systems may have additional instructional or achievement expectations and may provide instructional guidelines that address content sequence, review, and remediation.

The instructional supports are organized by standard. Each standard’s instructional support includes a statement of the content standard, guiding questions with connections to three-dimensional learning, key academic terms, and additional resources.

Content Standards

The content standards are the statements from the 2015 *Alabama Course of Study: Science* that define what all students should know and be able to do at the conclusion of a given grade level or course. Content standards contain minimum required content and complete the phrase “Students will _____.”

Guiding Questions with Connections to the Three Dimensions

Guiding questions are designed to create a framework for the given standards and to engage students in exploring, explaining, and expanding their understanding of the content standards provided in the 2015 *Alabama Course of Study: Science*. Therefore, each guiding question is written to help educators convey important concepts within the standard. By utilizing guiding questions, educators are engaging students in investigating, analyzing, and demonstrating knowledge of the underlying concepts reflected in the standard.

An emphasis is placed on the integration of the Three Dimensions of learning as described in the 2012 National Research Council publication *A Framework for K–12 Science Education: Practices, Crosscutting Concepts, and Core Ideas*.

Each content standard in the 2015 *Alabama Course of Study: Science* blends knowledge and skills linked to science and engineering that all students should know and be able to do by the end of high school.

The Three Dimensions are the same for all grade levels and are described below.

1. Scientific and Engineering Practices are skills and tools used by students to investigate phenomena, develop and use models, design and build systems, and construct arguments based on evidence to solve problems in the world in which they live.
2. Crosscutting Concepts are unifying conceptual threads that encourage students to connect scientific and engineering ideas across the domains of science.
3. Disciplinary Core Ideas in the four domains of Physical Science, Life Science, Earth and Space Sciences, and Engineering Technology include relevant content that provides students with foundational scientific knowledge.

Each guiding question includes a representative set of sample activities and examples that can be used in the classroom. The set of activities and examples is not intended to include all the activities and examples that would be relevant to the standard.

Key Academic Terms

These academic terms are derived from the standards and are to be incorporated into instruction by the educator and used by the students.

Additional Resources

Additional resources are included that are aligned to the standard and may provide additional instructional support to help students build toward mastery of the designated standard. Please note that while every effort has been made to ensure all hyperlinks are working at the time of publication, web-based resources are impermanent and may be deleted, moved, or archived by the information owners at any time and without notice. Registration is not required to access the materials aligned to the specified standard. Some resources offer access to additional materials by asking educators to complete a registration. While the resources are publicly available, some websites may be blocked due to Internet restrictions put in place by a facility. Each facility's technology coordinator can assist educators in accessing any blocked content. Sites that use Adobe Flash may be difficult to access after December 31, 2020, unless users download additional programs that allow them to open SWF files outside their browsers.

Your Feedback

ALSDE and DRC value your feedback. The last two pages of this document contain a survey about your experience using the Alabama Educator Instructional Supports. Once you have had a chance to use and become familiar with these Instructional Supports, please take the time to fill out the survey. The Instructional Supports, as well as your responses to the survey, will be discussed during an educator review meeting in summer 2021.

Printing This Document

It is possible to use this entire document without printing it. However, if you would like to print this document, you do not have to print every page. First, identify the page ranges of the standards or domains that you would like to print. Then, in the print pop-up command screen, indicate which pages you would like to be printed.

Grade 6

Earth's Place in the Universe

6.ESS.1 Create and manipulate models (e.g., physical, graphical, conceptual) to explain the occurrences of day/night cycles, length of year, seasons, tides, eclipses, and lunar phases based on patterns of the observed motions of celestial bodies.

Connections to *A Framework for K–12 Science Education: Practices, Crosscutting Concepts, and Core Ideas:***Focus for Scientific and Engineering Practice(s):**

- Developing and Using Models

Focus for Crosscutting Concept(s):

- Patterns
- Cause and Effect

Focus for Disciplinary Core Idea(s):

- The Universe and Its Stars
- Earth and the Solar System

Key Academic Terms:

orbit, rotation, revolution, tilted axis, high tide, low tide, gravity, tidal bulge, lunar eclipse, solar eclipse, full moon, new moon, Earth/moon alignment, Earth-moon-Sun system, physical model, graphical model, conceptual model, waxing, waning, crescent, celestial

Safety Considerations

Please refer to the [Alabama State Department of Education Lab Safety Guidelines](#).

How can models be used to demonstrate the rotation and revolution within the Earth-moon-Sun system?

What is responsible for the day/night cycle on Earth?

What motion corresponds to one year on Earth?

What is the relationship between the orbital and rotational periods of the moon and Earth?

Background

The motions of bodies in the solar system are usually regular and understandable. The two primary motions of celestial bodies are rotation and revolution. Rotation is the spinning motion of a body with respect to its axis. Earth's axis is currently tilted at a 23.5° angle. Earth rotates on its axis once every 23 hours and 56 minutes. This time is rounded to 24 hours, the length of a complete day. Day is the time during which part of a planet is facing the Sun. Night is the time during which that same part of a planet is facing away from the Sun. Each planet has a different rate of rotation about its axis. The moon also rotates about its axis. The moon's axis is at angle of about 5° from the perpendicular. It rotates once every 27.5 days. The Sun also rotates on its axis, but the area of the Sun at its equator rotates faster than the areas at its polar regions. At its equator, the Sun rotates once every 24 days, while at its poles, the Sun rotates once every 35 days, for an average rotation of once every 27 days.

Revolution is another motion common to celestial bodies. Revolution is the movement of one object around another. Because the Sun is located in the center of our solar system, objects revolve around it. Earth revolves around the Sun about once every 365.25 days, the length of one solar year. The moon revolves around Earth about once every 27.3 days. The similar time periods in which the moon rotates about its axis (27.5 days) and revolves around Earth (27.3 days) is the reason why we only see one side of the moon from Earth.

Activities and Considerations

Activity 1

To help students internalize the meaning of the words rotation and revolution, have them do limited research on planets in our solar system. Students should examine the rotation data from a reliable source (reputable website, textbook, etc.) and identify two planets with unusual rotation periods (e.g., Venus and Uranus).

Students should then examine the revolution periods of the planets in our solar system and make a claim about their distances from the Sun and their revolution periods. If possible, students should provide supporting evidence for their claim. NASA's planetary fact sheet is a great resource for information about celestial bodies in our solar system. The link is provided in the Resources section below.

Activity 2

Have students create a model to show our Earth-moon-Sun system. Students can create a model in groups of two or three. An educator may also have class model sets pre-made and simply allow students to use them, as needed.

Materials:

- 3 differently sized balls (large-medium-small, plastic or Styrofoam),
- 3 small dowel rods (to represent axes),
- 1 marker, and
- 1 protractor.

To construct the model, students or the educator must insert a dowel rod into the center of each ball. The large ball represents the Sun, the medium ball is Earth, and the small ball is the moon. Earth is tilted on its axis at 23.5° , so a protractor should be used to adjust the model of Earth on its dowel rod.

Use the models to show the direction of rotation (counterclockwise) and to illustrate the revolution of each body. The revolution of the moon around Earth occurs in a counterclockwise direction, and the revolution of Earth around the Sun occurs in a counterclockwise direction. Using the model, a day/night cycle can be demonstrated as well as a year of Earth's revolution around the Sun.

Follow-up discussion prompts that can extend this investigation and use resources from Activity 1 include the following:

- Ask students to make claims about the length of day and night on each of the planets in our solar system.
- Ask students to make claims about the rotation of planets in our solar system and the length of day and night on those planets.
- Ask students to compare the distance from the Sun and the length of a year of each of the planets in our solar system.

Resources

- [Planetary Fact Sheet](#)—provided by NASA
- [NASA](#)—planet comparison tool
- [Space.com](#)—a reputable website for news and information
- [Open Data](#)—data sets provided by NASA

What is the relationship between Earth’s tilted axis of rotation and the seasons?

How can a model be manipulated to show different seasons in the northern and southern hemispheres?

Background

The revolution of Earth around the Sun causes the seasons. When a hemisphere is tilted toward the Sun, that hemisphere is experiencing summer. At that time, the opposite hemisphere is experiencing winter. Summer and winter are the two extremes in Earth’s revolution around the Sun. The two periods in Earth’s revolution that occur between winter and summer are spring and fall. During these two seasons, neither hemisphere is tilted toward the Sun and the most direct rays from the Sun impact Earth’s equator.

Activity

Have students model seasonal changes of Earth. If an Earth-moon-Sun model was created from the previous guiding question activity, it can be reused for this purpose as well. As the seasons are modeled, have students reflect on and discuss why seasons are not the same in both hemispheres of Earth.

Resources

- [Planetary Fact Sheet](#)—provided by NASA
- [NASA](#)—planet comparison tool
- [Space.com](#)—a reputable website for news and information
- [Open Data](#)—data sets provided by NASA

What are the four main lunar phases?

What patterns can be used to explain the lunar phases?

What are tides?

How could a model show tidal patterns (e.g., low tides, high tides, tidal bulges)?

Background

Lunar phases result from celestial motions. A lunar phase is a period during the moon's regular orbit around Earth when, from the perspective of observers on Earth, the visible portion of the moon has a particular shape. This phenomenon makes the shape of the moon appear to change over time to observers on Earth. Lunar phases are caused by the position of the moon in relation to Earth and the Sun.

The four main lunar phases include the new moon, full moon, first quarter, and third (last) quarter phases. They are classified by the amount of visible light reflecting off the moon. The diagram below shows the moon phases that are produced by changes in the Earth-moon-Sun system.

When the moon is completely concealed by the shadow of Earth, it is called a new moon. As observed from Earth, the amount of reflected light from the moon increases (waxes) from the right to the left until the first quarter moon occurs. The right side of the moon is visible during the first quarter phase, and the left side is concealed by the shadow of Earth. As the moon continues to wax, a full moon occurs when the moon is out of Earth's shadow and the entire moon surface reflects light. A full moon is the opposite of a new moon. After reaching the full moon phase, the visible portion of the moon, to an observer on Earth, begins to decrease (wane) from right to left until the third quarter moon is reached. The left side of the moon is visible during the third quarter phase, and the right side is concealed by the shadow of Earth. The amount of reflected light continues to wane until a new moon is reached again. This cycle repeats every 29.5 days, and each of the four main phases occurs about every seven days. There are also intermediate lunar phases, which are referred to by the terms "gibbous" or "crescent" (e.g., waxing gibbous).

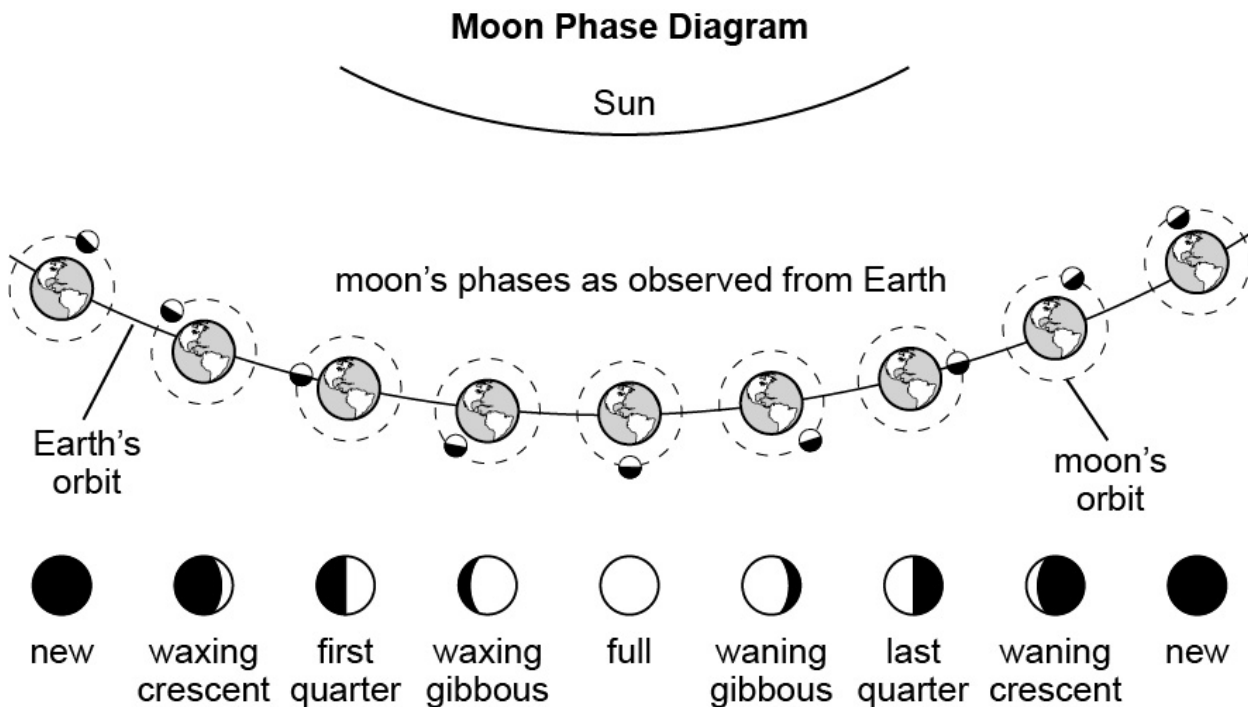

Tides are one of the most reliable phenomena on Earth. Tides are the periodic rise and fall of sea levels around the world. Tides are waves that move through the oceans in response to the gravitational forces exerted by the moon and the Sun. Tides start in the oceans and move toward the coastlines. The gravitational pull of the moon causes the water on Earth to bulge out on the side closest and farthest away from the moon, as shown in the diagram.

When a coastline travels through one of the bulges during Earth's rotation, it will experience a high tide. When the coastline passes an area between the bulges, it will experience a low tide. As Earth does a full rotation, most coastal regions will experience high tides as they travel through the bulges, and experience low tides as they travel through the areas between the bulges. Most coastlines will experience two high tides and two low tides each day. The difference in height between the high tide and the low tide at a given place is called the tidal range.

While the moon is the major influence on Earth's tides, the Sun also generates tides that are about half as large as lunar tides. When the Sun and the moon are aligned during a new moon or full moon, the gravitational forces combine, leading to more extreme tides, called spring tides. When the Sun and the moon are at 90° to one another during a first quarter moon or third (last) quarter moon, the tidal range is the lowest. These tides are called neap tides.

Eclipses are special alignments of celestial bodies. A lunar eclipse occurs when Earth's shadow blocks the Sun's light, which would otherwise reflect off the moon. A total lunar eclipse can be seen from any given location on Earth every 2.5 years.

A solar eclipse occurs when a new moon moves directly between the Sun and Earth, blocking out the Sun's rays and casting a shadow on parts of Earth. Total solar eclipses are rare events. A total solar eclipse occurs at any given place on Earth only once every 360 to 410 years, on average. Lunar eclipses are more widely visible than solar eclipses because Earth casts a much larger shadow on the moon during a lunar eclipse than the moon casts on Earth during a solar eclipse.

Activities and Considerations

Activity 1

Model lunar phases by using a light source, foam balls, and pencils.

Place a lamp on a desk in the center of an open area with the classroom lights off. Give each student a foam ball stuck onto the end of a pencil to represent the moon. Have students face the lamp and hold their models of the moon directly out in front of them and raised slightly above their heads. This placement of the model represents a new moon. Students should sketch and label what they see.

Now, students should turn their bodies a quarter to the left while keeping their models of the moon in the same position in front of them. With each quarter turn, they should sketch and label another lunar phase.

Phases of the Moon from Student Perspective

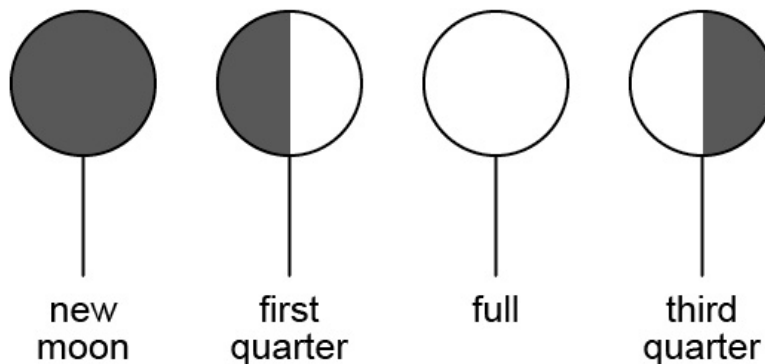

Activity 2

Review the following diagram with students and demonstrate the effect of the moon on tides.

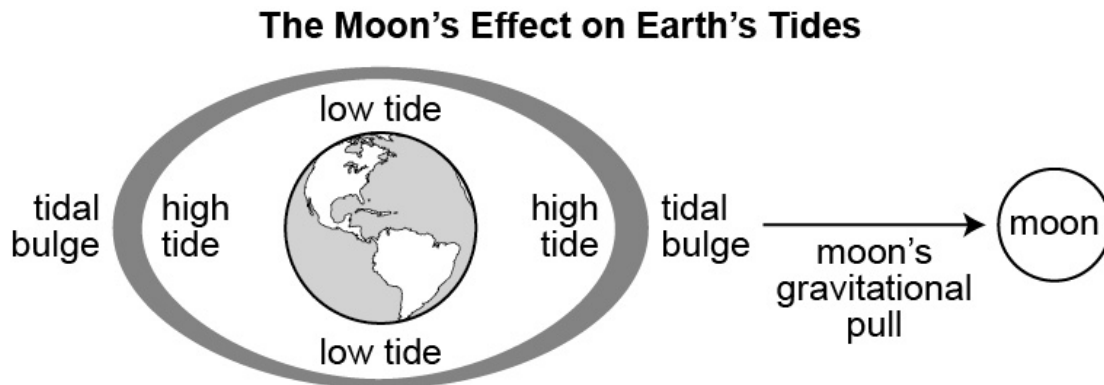

The Earth-moon-Sun model from the first guiding question can be reused for this demonstration but should be placed on a flat surface with its dowels removed. Students or the educator can use the model to show the alignment of the three celestial bodies during a high tide. A rubber band larger in diameter than the Earth ball will represent oceans on Earth. Add the moon ball to one side of Earth and adjust the rubber band to show how the gravitational pull of the moon affects tides in the oceans. At this point, a question can be posed to students about what would happen if the moon were the same distance from Earth but had double its current mass. Now, place the Sun ball on the far side of the moon so that the three objects are in a line. Adjust the rubber band to best demonstrate how Earth's oceans would react to this alignment.

End the demonstration by having students reflect on the following questions:

- How is rotation involved in the formation of tides?
- How is revolution involved in the formation of tides?
- How much time passes between two high tides?

Activity 3

Assemble an Earth-moon-Sun model that is similar to the one shown below. For this demonstration, use either a commercial model or your model from the first guiding question with the addition of a sturdy wire to connect the Earth and moon balls.

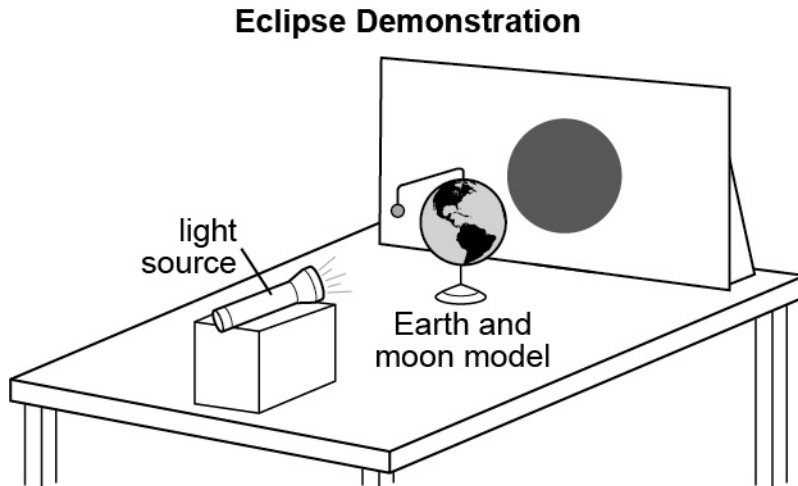

Turn on the flashlight, turn off the classroom lights, and align the celestial bodies in the following order to show a lunar eclipse: Sun, Earth, moon.

Then, align the celestial bodies in the following order to show a solar eclipse: Sun, moon, Earth.

Slightly rotate Earth to show that the moon's shadow on Earth follows a relatively narrow pathway. That is how scientists predict the areas that will see the eclipse and those that will not.

Considerations

Many online images of Earth's revolution around the Sun are inaccurate. Make sure that any online images shown in class account for the tilt of Earth and are appropriately labeled.

Misconceptions about day and night:

- The Sun sets behind hills.
- Clouds cover the Sun to make night.
- The moon covers the Sun to make night.
- The Sun goes behind Earth once a day.
- Earth goes around the Sun once a day.
- The Sun moves across the sky.
- Earth rotates in a clockwise manner.
- The phases of the moon are a result of Earth's shadow being cast upon the surface of the moon by the Sun.

Misconceptions about seasons:

- Earth is closer to the Sun during summer and farther away during winter.
- Seasons happen at the same time everywhere on Earth.

Misconception about tides:

- High tides and low tides occur infrequently (weekly, or monthly, rather than daily).

Misconceptions about eclipses:

- There are no total solar eclipses at Earth's north or south poles.
- The moon turns completely black during a total solar eclipse.

Extensions:

An educator may choose to cover or review elliptical orbits while covering this standard. The diagram below helps to illustrate that Earth's orbit of the Sun and the moon's orbit of Earth are both elliptical. These orbits also affect tides.

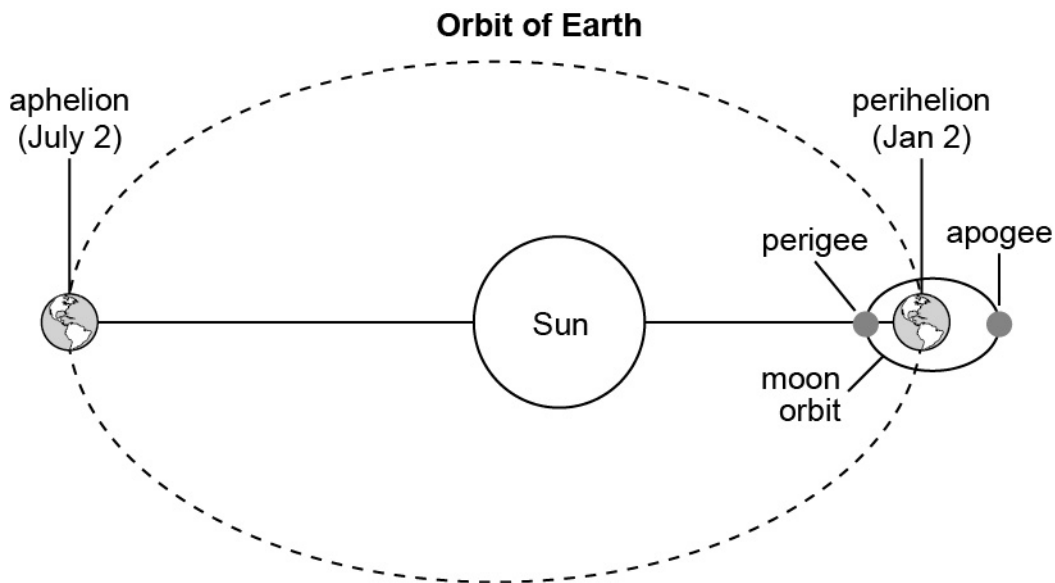

A few new terms must be introduced to go along with this diagram. Ask students to make inferences about how tides might relate to each of these new terms.

perihelion: the point in the orbit of a planet, asteroid, or comet at which it is closest to the Sun.

aphelion: the point in the orbit of a planet, asteroid, or comet at which it is farthest from the Sun.

perigee: the point in the orbit of the moon or a satellite at which it is nearest to Earth.

apogee: the point in the orbit of the moon or a satellite at which it is farthest from Earth.

Resources

- [Moon Phases Demonstration](#)—activity designed to allow students to act out lunar phases from NASA
- [What are Tides?](#)—brief overview on what tides are and how they are formed from NOAA
- [Predicting the Tides](#)—instructional resource about predicting tides on Earth from NOAA
- [What are Lunar Phases and Eclipses?](#)—explanations of lunar phases and eclipses from NASA
- [Planet Comparison](#)—planet comparison tool from NASA
- [What Causes the Seasons?](#)—brief overview of the causes of seasons from NASA

Grade 6

Earth's Place in the Universe

6.ESS.2 Construct models and use simulations (e.g., diagrams of the relationship between Earth and man-made satellites, rocket launches, the International Space Station, elliptical orbits, black holes, life cycles of stars, orbital periods of objects within the solar system, astronomical units and light years) to explain the role of gravity in affecting the motions of celestial bodies (e.g., planets, moons, comets, asteroids, meteors) within galaxies and the solar system.

Connections to *A Framework for K–12 Science Education: Practices, Crosscutting Concepts, and Core Ideas:***Focus for Scientific and Engineering Practice(s):**

- Developing and Using Models
- Constructing Explanations and Designing Solutions

Focus for Crosscutting Concept(s):

- Systems and System Models
- Patterns

Focus for Disciplinary Core Idea(s):

- The Universe and Its Stars
- Earth and the Solar System

Key Academic Terms:

gravity, orbit, satellite, black hole, elliptical orbit, orbital period, celestial body, solar system, galaxy, universe, asteroid, comet, meteor

Safety Considerations

Please refer to the [Alabama State Department of Education Lab Safety Guidelines](#).

How is the gravitational pull between two objects affected by changes in mass or distance?

Background

A student's primary experience with gravity may be observing a pen or pencil falling off a table and hitting the floor. Gravity is a force that exists between all objects and has three characteristics:

1. It is an attractive force.
2. It is a universal force.
3. It is a mutual force.

All objects with mass act on one another. The force of gravity pulls all objects toward each other. Every object with mass exerts a gravitational force on every other object, and this is true on Earth and anywhere in the universe as well.

For example, in the case of a falling pencil, Earth attracts the pencil, but the pencil also attracts Earth. The more massive an object, the stronger its force of gravity. Earth has more mass than the pencil, so it has the greater gravitational force, which causes the pencil to move toward Earth.

Mass is the amount of matter in an object. The mass of an object never changes and is the same regardless of its location (whether on Earth or in space). Weight is the force of gravity acting on the mass of an object. The gravitational force on each planet varies, and as a result, the weight of the same object will also vary on different planets. The greater the force of gravity, the greater the weight of an object.

The other factor that affects gravity is the distance between objects. As the distance between objects decreases, the gravitational attraction between them increases.

Activities and Considerations

Activity 1

Have students use a reliable source to reference the mass and gravitational force of each planet in our solar system. NASA's planetary fact sheet is a great resource for information about celestial bodies in our solar system. The link is provided in the Resources section below. Students should calculate how the weight of an object would change depending on the gravity on the planet where the object was located.

Activity 2

Have students model gravity using vector diagrams. Students can divide a sheet of paper into three sections. In section 1, have them draw two equally sized circles about 2 inches apart. These circles represent 2 objects in space. Have students draw 1 arrow from each object that points to the other object. These arrows should be the same length and thickness.

In section 2, have students draw two larger circles, each on each side of their paper. The larger circles represent objects with more mass. Ask students to describe the force of gravity between these objects before drawing them. Discuss with students how and why the arrows should look different from the arrows in the first image and then have them add in the arrows to their second image.

In section 3, have students draw 2 equally sized circles near the very (opposite) edges of their paper. These circles represent objects very far from each other. Ask students to describe the force of gravity between these objects before drawing them. Discuss with students how and why the arrows should look different in this situation and then have them add arrows to their third image.

Activity 3

This lab helps demonstrate the force of gravity. The educator should assemble enough kits for all students in the class. Each kit should contain the following materials:

- One 6-inch dowel rod
- 3 pieces of string, each 3 inches in length
- 3 metal paper clips
- 3 strong 1/2-inch or larger magnets (neodymium magnets are recommended)
- ruler
- 10 blocks for stacking (or textbooks will work if blocks are not available)
- 3 pieces of tape

Two investigations can be performed with these materials.

Investigation 1:

1. Tie one end of a string to the dowel rod. Tie a paper clip to the other end of the string.
2. Hold the dowel rod above a table and observe the paper clip. Record your observations.
3. Tilt the dowel rod so that one end is closer to the table than the opposite end. Record your observations.
4. Disconnect the dowel rod from the string and set it aside. You will be using the string and paper clip in the next investigation.

Investigation 2:

1. Tape the 3 round magnets spaced equally apart on one side of a ruler.
2. Take two paper clips and tie one paper clip to the end of each of your remaining two strings. (You already have one string with a paper clip tied to its end from the previous investigation.)
3. Stack the blocks or textbooks into two equally sized stacks. Place the ruler, magnet-side down, across the two stacks.
4. Take one string and paper clip and hold the paper clip below one of the magnets where you can feel the pull of a magnet.
5. Tape the string attached to that paper clip to the table so that the pull of the magnet keeps the paper clip suspended in the air.
6. Repeat step 5 using the remaining 2 paper clips and the other 2 magnets. Record your observations.
7. Draw a vector diagram to represent each investigation. Then, state a claim based on each investigation.

Considerations

Common misconceptions include the following ideas:

- Gravity is related to movement, proximity to Earth, or magnetic fields.
- The moon has no gravity.
- Planets with thin atmospheres have little gravity.
- Planets distant from the Sun have less gravity.
- Gravity is stronger between the most distant objects.
- Space shuttle astronauts are weightless because there is no gravity above Earth.

Resources

- [Planetary Fact Sheet](#)—chart listing characteristics of the planets in our solar system from NASA
- [Your Weight on Other Worlds](#)—online calculation of a person’s weight on other planets from exploratorium.edu
- [Gravitational Force Summation](#)—overview of Isaac Newton’s development of the Law of Universal Gravitation by Professor Richard Pogge (Stanford University)

What is the relationship between gravity and the orbital pattern of an object?

How can orbits, orbital periods, and orbital motion be explained using models?

If an object was orbiting Earth and gravity ceased, how would the motion of that object change?

What is the relationship between the orbital period of an object in our solar system and the distance of that object from the Sun?

How does gravity affect the locations and movements of planets, moons, comets, meteors, and asteroids?

Background

All objects in our solar system revolve around the Sun and each object has a specific orbit. Orbits are the result of a balance between the forward motion of the object (planet, moon, or comet) and the pull of gravity on that object from other objects in space. Because of this balance, an orbit can be defined as a regular, repeating path that an object in space takes around another object.

An object that orbits another object is called a satellite. One kind of orbit is circular. Circular orbital motion is the result of a pull from the larger object (such as a planet) and a push from the satellite's forward motion (such as a moon). In a circular orbit, the force of gravity acts in a direction perpendicular to the direction in which the satellite is moving. Therefore, the speed of the satellite is constant. If the strength of gravity became an unbalanced force, the satellite would either crash or float away, depending on the situation.

The other kind of orbit is elliptical. When a satellite orbits in an elliptical motion, its speed is not constant. For example, the planets in our solar system travel in elliptical orbits around the Sun. The primary influence on the orbits of planets is the gravitational force of our massive Sun.

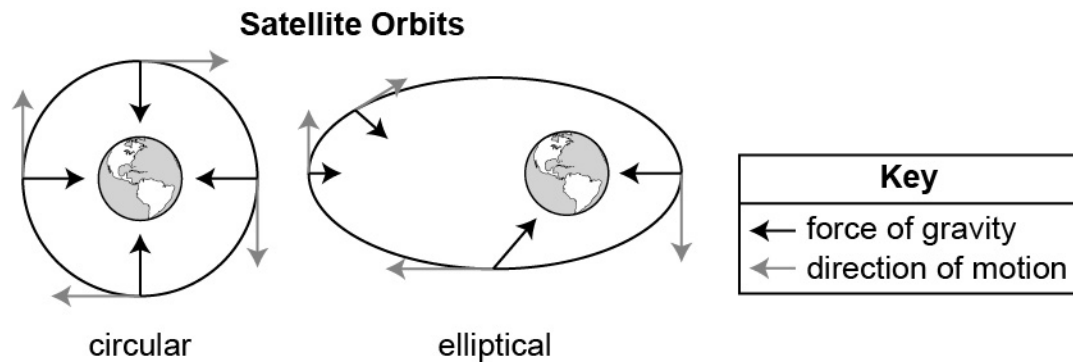

Comets are pieces of matter left over from the formation of stars and planets that occurred billions of years ago. Comets that we see in our solar system start as large chunks of rock and ice floating in an area called the Oort cloud. The gravity of our Sun pulls some comets into our solar system. As a comet gets closer to the Sun, heat begins to melt some of its ice ball, and the melting ice becomes a gaseous tail. Solar winds make that tail longer and cause it to extend away from the source of the heat, the Sun. As a comet approaches the Sun, its speed and tail length increase.

Asteroids are rocky objects that are much smaller than planets that orbit the Sun. They are the remnants of the formation of our solar system. Large amounts of iron (Fe) and nickel (Ni) make up asteroids. Due to these elements, asteroids have great mass and gravitational force. Most asteroids reside in the asteroid belt that is between Mars and Jupiter, while others are found in the orbital pathways of planets.

A meteoroid is a small piece of space matter, such as a fragment of an asteroid that has broken loose. When a meteoroid enters Earth's atmosphere and burns, it is called a meteor. This burning is the result of friction caused by the air molecules trapped in the atmosphere. Humans often observe meteors as streaks of light in the sky. The remains of a meteor that can be found on Earth's surface are called meteorites.

Activities and Considerations

Activity 1

Have students research and make claims about the orbital periods and the orbital speeds of the planets in our solar system.

Activity 2

An educator can use the Low Earth Orbit and Space Junk resource to put together a brief presentation or lead a discussion for students. Show students the main image from the webpage and have them describe the types of satellites that humans put in orbit around Earth.

Inform students that satellites can be in either low orbits or high orbits of Earth. A *low Earth orbit* (LEO) has an altitude of 2,000 km (1,200 mi) or less above Earth. A high Earth orbit (HEO) is any orbit beyond 2,000 km. Ask students to brainstorm about what they think happens to satellites in low Earth orbits when those objects are no longer needed. (They should conclude that satellite speed will eventually slow and gravity will pull them to Earth. Some of these satellites burn in Earth's atmosphere due to friction with air molecules. Some of the satellites reach Earth's surface.)

Inform students that scientists can influence when and where a satellite enters Earth's atmosphere. Ask students to brainstorm the advantages of a scientist-generated satellite re-entry. (Scientists can determine the area on Earth where waste accumulates. This is the Spacecraft Cemetery in the Pacific Ocean.)

Considerations

Common misconceptions include the following ideas:

- A celestial body in orbit is weightless because the force of gravity is no longer acting on it.
- Weight and mass are the same thing.
- Comets and asteroids are the same thing.

Resources:

- [Low Earth Orbit and Space Junk](#)—website containing useful information for research
- [Illustrations of Orbits](#)—website hosted by Northwestern University
- [News Article on Meteors](#)—presented by *Scientific American*
- [Information on Asteroids](#)—provided by NASA

What is a black hole?

How can models and simulations describe black holes and explain what happens to an object as it approaches a black hole?

Background

A black hole is an area in space where the strength of gravity is so attractive that even light cannot escape. The gravity in a black hole is very strong because a huge amount of matter has been squeezed into a tiny space. Black holes sometimes indicate the death of a star. Scientists have determined that stars with a mass at least three times that of Earth's Sun can experience a gravitational collapse when all the atoms that fuel them have been consumed. This collapse squeezes a large amount of mass into a tiny, confined space.

A black hole cannot be seen. Scientists use space telescopes with special tools that help them locate black holes in space. Black holes can range in size from only 1 atom to larger than 1 million times the size of Earth's Sun. Scientists have found proof that virtually every large galaxy contains a supermassive black hole at its center. The black hole at the center of the Milky Way galaxy is called Sagittarius A. Its size is equivalent to a few million Earths, and it has a mass equal to about 4 million times the mass of Earth's Sun.

Activity and Considerations

Activity

This lab helps to model black holes. The educator should assemble enough kits for groups of three students in the class. Each kit should contain the following materials:

- A large rectangular piece of stretchy fabric, like a polyester/lycra T-shirt (not cotton)
- A round, heavy object, like an apple, orange, or pool ball
- Two marbles or ping pong balls

Students should hold the fabric flat in the air by the corners until the fabric is taut. Students should then place a marble somewhere on the fabric and observe its motion. Students should record their observations of the marble. Now, a student should roll a marble across the fabric and observe how it moves. Students should record the shape of the pattern it follows. Next, they should place a round, heavy object in the middle of the fabric, making sure that the fabric is pulled tightly enough that it does not have any wrinkles or bumps in it. Students should observe what happens to the fabric and record their observations. With the heavy object still on the fabric, they should place a marble near the edge of the fabric and let it go. Students should then record their observations. Finally, students should attempt to roll the marble from one side of the fabric to the other. Students can try rolling the marble across the fabric at different speeds. They should reflect on whether they were able to successfully roll the marble across the

fabric and observe the shape of the marble's path. Students can then roll two marbles on the fabric at once to see if the marbles affect each other's motion (assuming they do not collide) and record their observations.

Educator Key: If you roll the marble across the flat fabric, it moves in a straight line. When you place a heavy ball in the middle of your fabric, it causes the fabric to curve downward. Now, it's impossible to get the marble to hold still—it always rolls towards the middle. When you try to roll the marble in a line, it follows a curved path. If the marble doesn't get too close to the middle, you could probably still roll it from one end of the fabric to the other. However, if it gets too close to the center, the marble gets sucked in and cannot escape. When two marbles are rolled at once, they do not really affect each other's motion (assuming they don't collide). This is because the marbles are not heavy enough to introduce any additional curvature in the fabric. All the curvature is due to the much heavier ball in the middle.

Considerations

Common misconceptions include the following ideas:

- Black holes have no mass.
- All black holes are very massive.
- All black holes are very dense.
- Black holes suck everything in.
- Black holes appear black.

Resources

- [Black Holes](#)—activity directions hosted by Science Buddies website
- [What is a Black Hole?](#)—resource on black holes from NASA

Grade 6

Earth's Place in the Universe

6.ESS.3 Develop and use models to determine scale properties of objects in the solar system (e.g., scale model representing sizes and distances of the Sun, Earth, moon system based on a one-meter diameter Sun).

Connections to *A Framework for K–12 Science Education: Practices, Crosscutting Concepts, and Core Ideas:***Focus for Scientific and Engineering Practice(s):**

- Developing and Using Models
- Analyzing and Interpreting Data

Focus for Crosscutting Concept(s):

- Scale, Proportion, and Quantity

Focus for Disciplinary Core Idea(s):

- Earth and the Solar System

Key Academic Terms:

scale model, celestial body, solar system, ratio, distance, proportion, astronomical unit, light-year

Safety Considerations

Please refer to the [Alabama State Department of Education Lab Safety Guidelines](#).

What is a solar system?

What is the arrangement of planets in our solar system?

Background

A solar system is a collection of celestial bodies held together by gravity. Earth's solar system consists of a central star (the Sun) and the planets, moons, comets, asteroids, and meteoroids that orbit it. Earth's solar system consists of eight planets, five recognized dwarf planets, more than 200 moons, 6,619 comets, and more than 150 million asteroids. Also, each day, more than 25 million meteors are in Earth's atmosphere alone! The drawing below represents the relative positions of the planets in our solar system. The drawing is not to scale.

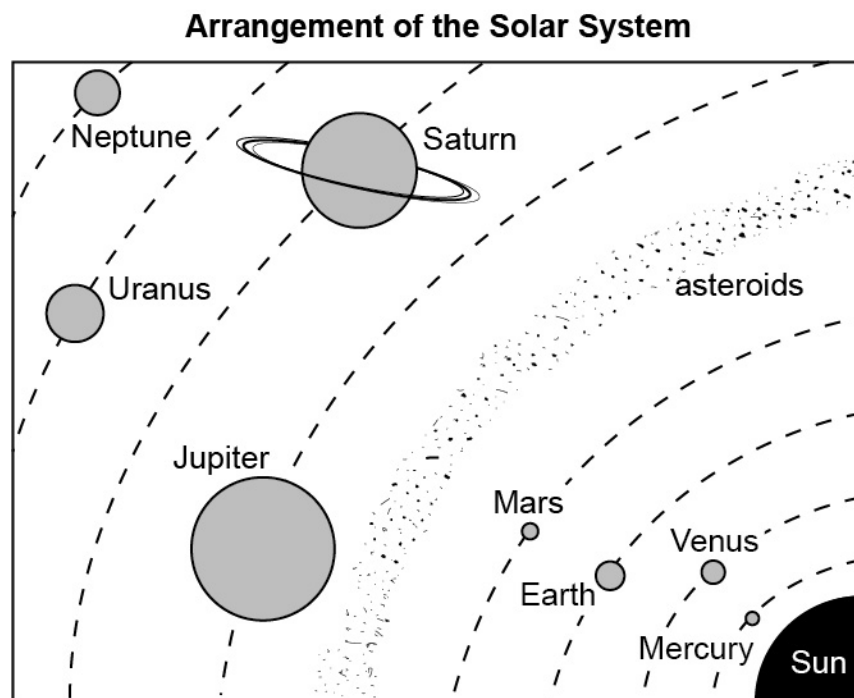

Activity and Considerations

Activity

Have students use a reliable source to determine each planet's distance from the Sun, each planet's distance from the other planets, and each planet's distance from the asteroid belt.

Considerations

Common misconceptions include the following ideas:

- There are stars in our solar system other than our Sun.
- The center of the solar system is Earth, about which the other celestial objects revolve.
- The solar system formed during the big bang, along with the rest of the universe.
- The solar system is the same as our galaxy.
- Earth is the largest object in the solar system.
- The solar system is very crowded.
- The Sun is not a star.
- The solar system only includes the Sun, planets, and our moon.
- Pluto is a planet.
- Pluto is farther away from Earth than the stars.
- Planets cannot be seen without a telescope.
- Planets appear in the same place every night.
- Gas giants are large balls of gas that a spaceship could fly through.
- Mars is hot.
- Mars is larger than Earth.
- All planets have rocky surfaces.

How can a scale model be used to represent the relative sizes of celestial bodies in the solar system?

How can a scale model be used to represent the relative distances between celestial bodies in the solar system?

Background

A scale model is a representation or copy of an object that is larger or smaller than the actual size of the object being represented. There are many models of our solar system, and each focuses on a specific aspect of the solar system. Many models are designed to show the order of the planets according to their distance from the Sun. Some models represent the size relationship of the planets in our solar system, while other models indicate the distance of planets from our Sun and from each other.

Scaled Model Comparing Sizes of Celestial Bodies

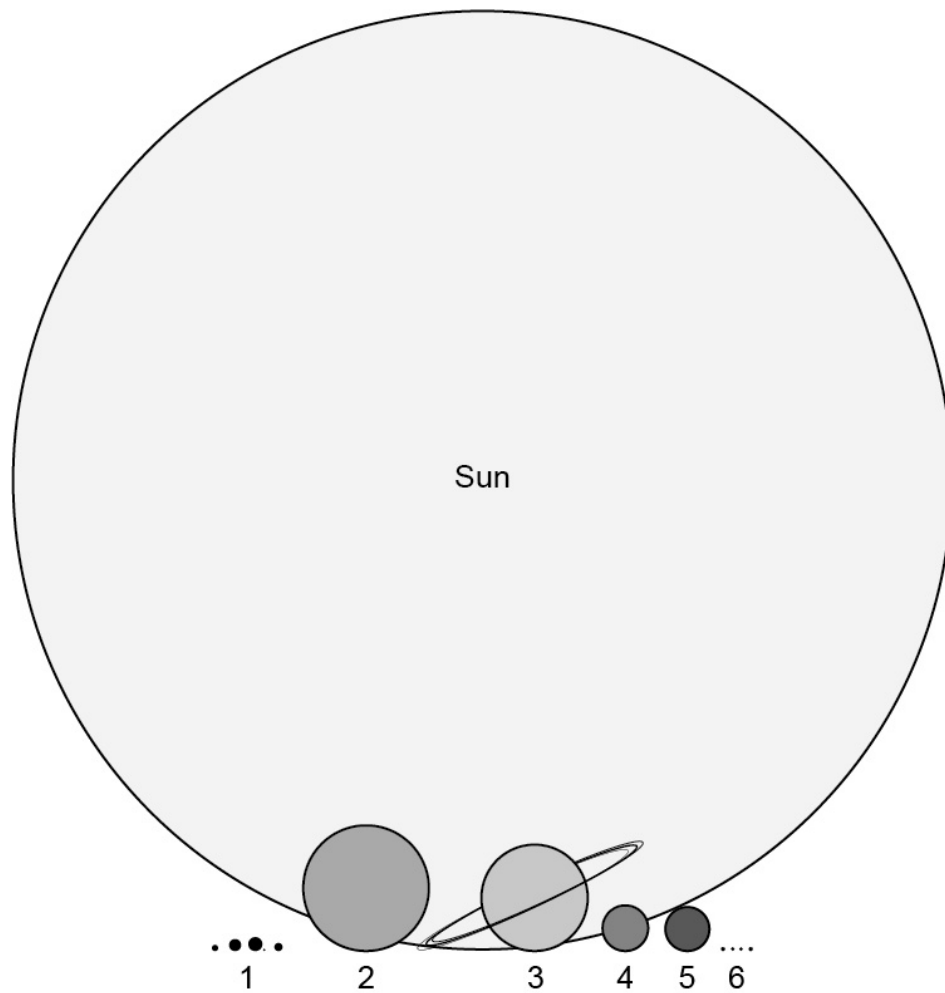

Key	
1. Mercury, Venus, Earth & moon, Mars	4. Uranus
2. Jupiter	5. Neptune
3. Saturn	6. Dwarf Planets (4)

Activities and Considerations

Activity 1

Have students find an image of Earth’s solar system and then show them a video that explains why most of these images are not drawn to scale. A link to the video is provided in the “Resources” section below.

Activity 2

Have students construct a scale model of Earth’s solar system using the following supplies:

- 5-meter strip of paper (a roll of receipt paper or 2-inch-wide roll of butcher paper)
- Meter sticks
- Planetary fact sheet (provided by the educator)
- Calculator

First, divide students into groups of two or three, and have each group make a data table with three columns, as shown below. The first column should be labeled “Planet”; the second column should be labeled “Distance from Sun”; and the third column should be labeled “Distance in Centimeters.”

Planet	Distance from Sun	Distance in Centimeters
Neptune	4495.1×10^6 km	499 cm

Provide each group with a 5-meter strip of paper and have students color the very edge of one end of the tape yellow and label that end “Sun.” Discuss with students how many centimeters make up five meters (500 cm).

Demonstrate to students how to establish their scale:

1. 5 meters = 500 centimeters = the total width of Earth’s solar system model.
2. Distance of the furthest planet from the Sun = 4495.1×10^6 km = distance of Neptune.

Then, instruct students to put Neptune at 499 centimeters from the Sun by drawing a line one centimeter from the end of the paper opposite the Sun and labeling that line “Neptune.”

Explain to students that this equality has set the scaling for their model and for additional planets. Therefore, the relationship between Neptune’s distance from the Sun and any other planet’s distance from the Sun is calculated using the equation below:

$$\frac{499 \text{ centimeters}}{4,495.1 \times 10^6 \text{ km}} = \frac{? \text{ centimeters}}{\text{distance from Sun}}$$

Students should complete their data table first and then draw lines on the paper strip to represent the orbits of all the planets in Earth’s solar system. Educators can provide the answers or help students with the calculations.

Considerations

Be certain to indicate that because all distances are $\times 10^6$ km, students can simply write “ $\times 10^6$ ” at the end of each computation. They do not need to put “ $\times 10^6$ ” into their calculators. It is easier to work on these calculations without the powers of 10.

Resources

- [Scale of the Universe Video](#)—created by Alex Gorosh and Wylie Overstreet; set in the Black Rock Desert
- [Real World: Scaling the Solar System](#)—video provided by NASA
- [Scale of the Universe Interactive](#)—Flash simulation that may only work until Jan 2021
- [General information on Earth’s Solar System](#)—provided by NASA
- [Smaller Scale Version of Activity 2](#)—provided by NASA

How are astronomical units and light-years used to represent large distances in space?

What are the benefits and drawbacks of modeling large-scale systems, like the ones present in space?

Background

Scientists who study space use an astronomical unit (AU) when measuring distances in Earth's solar system.

1 astronomical unit = average distance between Earth and the Sun

1 AU = 93 million miles

1 AU = 150 million kilometers (150×10^6 km on most references)

Most objects in space are farther away from Earth than the Sun is. To measure those long distances, a unit called a light-year is used. One light-year (LY) is the distance light can travel in one year in a vacuum (empty space). The speed of light is about 186,000 miles per second or about 300,000 km per second. There are advantages and disadvantages to using either astronomical units or light-years for studying space.

Activity and Consideration

Activity

Have students perform various calculations to become comfortable with units and scale. Examples may include the following calculations and exercises:

- Have students convert speed of light from miles per second to miles per year.
- Have students convert speed of light from km per second to km per year.
- Explain to students that aside from our Sun, the nearest stars to Earth are Alpha Centauri A and B, a binary star system that is 4.3 light-years from Earth. Then, have students convert 4.3 light-years to both km and miles.
- Have students list advantages of using light-years or astronomical units for space calculations.
- Have students list disadvantages of using light-years or astronomical units for space calculations.

Consideration

To help reinforce previous and current concepts, an educator may ask students why the average distance between Earth and the Sun is used as the reference point for an astronomical unit, instead of an exact measurement of this distance.

Resources

- [Understanding Light-Years](#)—video provided by TED-Ed
- [Scaling the Solar System](#)—video about astronomical units by NASAeClips

Grade 6

Earth's Systems

6.ESS.4 Construct explanations from geologic evidence (e.g., change or extinction of particular living organisms; field evidence or representations, including models of geologic cross sections; sedimentary layering) to identify patterns of Earth's major historical events (e.g., formation of mountain chains and ocean basins, significant volcanic eruptions, fossilization, folding, faulting, igneous intrusion, erosion).

Connections to *A Framework for K–12 Science Education: Practices, Crosscutting Concepts, and Core Ideas:***Focus for Scientific and Engineering Practice(s):**

- Constructing Explanations

Focus for Crosscutting Concept(s):

- Scale, Proportion, and Quantity

Focus for Disciplinary Core Idea(s):

- The History of Planet Earth

Key Academic Terms:

geologic cross section, geologic profile, igneous rock, sedimentary rock, metamorphic rock, intrusion, marine fossils, terrestrial fossils, extinction, ocean basin characteristics, erosion, deposition, compaction, sedimentation, magma, mineral replacement, tar pit, law of superposition, ice core

Safety Considerations

Please refer to the [Alabama State Department of Education Lab Safety Guidelines](#).

What are examples of Earth’s major historical events?

How can the patterns in Earth’s major historical events be explained using geologic evidence?

Background

Geologists use the rock beneath our feet to tell the story of Earth’s past. During its history, Earth has undergone a variety of historical events. These events include the formation of mountain chains and ocean basins, the rise and extinction of particular living organisms, volcanic eruptions, periods of massive glaciation, and the development of watersheds and rivers through glaciation and water erosion.

By analyzing the shapes of landmasses and fossil history, geologists have shown that current continents were not always located in the places they are currently found. Many years ago, a super landmass known as Pangaea broke apart. During the movement of the smaller landmasses, some of them collided, forming mountains. Some crustal material is no longer found at Earth’s surface because it has been pulled into the mantle and melted. Ice core samples taken in polar regions tell the story of a changing atmosphere. Analysis of this evidence has shown that levels of carbon dioxide in our atmosphere have changed over time, and this analysis has also shown that current oxygen levels are greater than oxygen concentrations in the past.

Geologic evidence shows that photosynthetic organisms (producers) began to make our atmosphere rich with oxygen hundreds of millions of years ago. There is also evidence of catastrophes in our geologic history. Earth has had 5 mass extinction events, where over half of the species living at that time, died out in a relatively short time. Evidence shows that about 90% of all marine (aquatic) life and 70% of all terrestrial (land) life ceased during one massive extinction event. Also, many scientists theorize that later Earth was struck by a massive asteroid, which caused another mass extinction event. Fossils in deeper rock layers have not been found in more recent rock layers due to these mass extinction events. Life slowly recovers after these extinctions, and as a result, fossils of different organisms are more plentiful in upper rock layers.

Activity and Considerations

Activity

This activity involves students making a time line of past geologic activities on Earth.

Materials for this activity include

- rope,
- a meter stick,
- masking tape,
- paper clips, and
- infographic/time line of major events in Earth’s history (see “Resources” below).

The educator and students should follow these steps to construct their time line:

1. Cut a 4.6-meter piece of rope. Tape the ends to prevent fraying. The rope represents the history of Earth.
2. Have students place a piece of masking tape to mark each $\frac{1}{2}$ meter.
3. Divide students into groups. Assign each group a portion of the rope time line. Give each group 3–5 note cards.
4. On each note card, students should write a major event that occurred during their assigned time period on the time line.
5. Have students use paper clips to hang their note cards at the appropriate point on the rope time line.

Then, have students answer the following questions about the time line:

1. How much time is represented by $\frac{1}{2}$ meter? How much time is represented by 10 centimeters?
2. Precambrian time lasted from the formation of Earth until about 550 million years ago. What conclusions can be made about Precambrian time?
3. When did oxygen begin to accumulate in our atmosphere? What event most likely led to this oxygen accumulation?
4. What is the relationship between humans and the history of Earth?
5. What are major extinction events? When did they occur?

Considerations

A common misconception is that there is only one geological column for Earth. One geologic column would mean that every area on Earth would have the same rock sequence below the surface.

Specific dates and time lines of Earth's history may be a sensitive topic for some students and families. This activity can be conducted with or without specific dates. For example, the time line can be constructed to only show relative ages of historical events on Earth.

Resource

- [Age of Earth](#)—a geologic time infographic for students

What is a geologic profile or cross section?**How can a geologic profile be used to explain the relative ages of rocks?****What happens to a geologic profile when the ground is overturned?****How can geologic profiles be used to demonstrate the changes in a species over time?****What characteristics of ocean basins are reflected in geologic profiles?****How can geologic faulting and folding explain changes in landscapes?****What is an igneous intrusion and how is it demonstrated within a geologic profile?****How is the process of mountain building reflected in geologic cross sections?****How does erosion alter a geologic cross section?****Background**

Geologists can tell the story of a portion of Earth by evaluating the rock layers in that area. Geologists construct a geologic profile of an area, which is a graphic that shows the types of rocks, the types of fossils, and the arrangement of those layers with respect to the surface of the ground. A geologic profile represents the distribution of different kinds of fossil deposits and rocks, which also includes the geological structures caused by the movement of Earth's crust. A geologic profile is an essential resource for information about how the land can be used. The diagram below represents a simple geologic profile or cross section.

Activity and Considerations

Activity

There are countless geologic profiles available on the web. After working through several of these profiles as a class, students should be able to order geologic events and identify specific layers that indicate changes in the local environment.

Geologic Profile

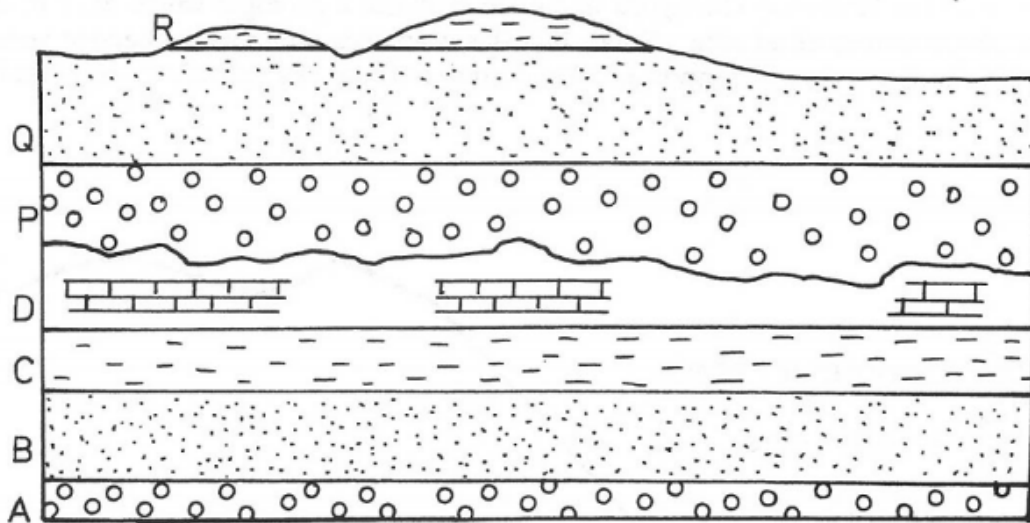

Considerations

Concepts to emphasize include the following ideas:

- One type of rock can be represented by different symbols. In the profile above, “A” and “P” represent the same type of rock.
- Rock layers are usually formed in parallel series.
- The oldest rock is at the bottom of a profile since it was the first layer deposited (layer A). The newest level is nearest the surface (layer R). This concept is known as the law of superposition.
- Not all rock layers are the same thickness.
- Erosion or an interruption in layers is shown as an unlevel line. For example, the layers between D and P are missing from the above profile.

Sometimes, pressure builds in Earth's crust, forcing some areas to bend. Anticlines are a type of geologic fold formed when rock layers bend upward. Synclines are folds formed when the rock layers bend downward. Sometimes, the pressure from Earth's crust forces rock layers to break. This zone where the rock is broken is called a fault. A sudden movement of rock layers along a fault results in an earthquake. A fault is shown in a geologic profile by offsetting the horizontal rock layers. There are three types of faults: normal, reverse and strike-slip.

Certain types of rocks are associated with certain events. Volcanic eruptions are indicated by deposits of igneous rocks. Marine areas are indicated by the deposition of limestone from the shells and skeletons of marine organisms. Metamorphic rocks are common in areas that experience tremendous pressure. Metamorphic rocks are common in mountains.

Each layer in a geologic profile is another chapter in the history of Earth. Like a book, the history of Earth has an order. By closely analyzing the layering of rock and the signs of faulting and folding, geologists can order the events in a geologic profile.

Cross Section of Ground

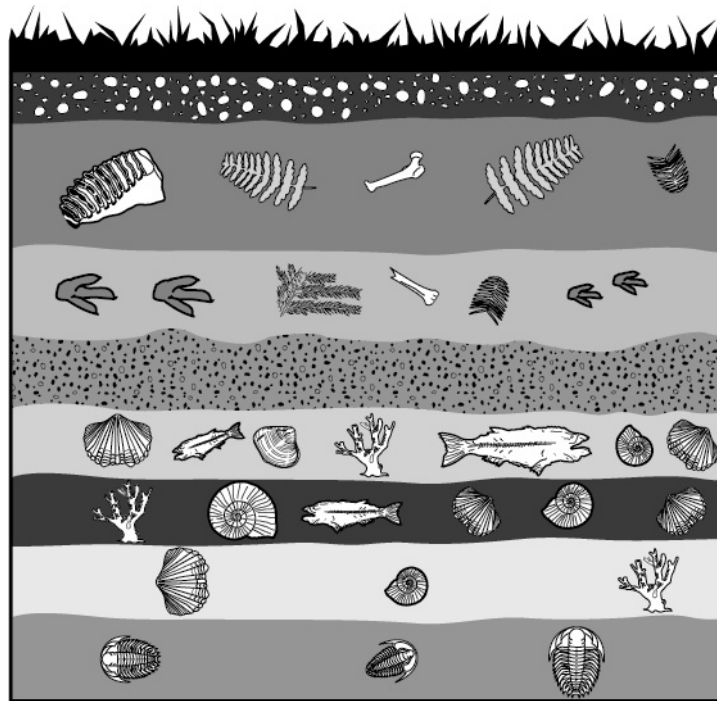

Some questions to reinforce key concepts include the following:

1. What are some events that may have caused the changes shown in the rock layers of the geologic profile?
2. Why are the rock layers different colors?
3. What can be concluded if the fossil remains of an organism no longer appear above a specific rock layer in the geologic profile?

What processes occur during fossilization?

Why are most fossils found in sedimentary rock layers and not in igneous or metamorphic rock layers?

Background

A fossil is the preserved remains, impression, or trace of any once-living thing from a past geological age. Footprints, bones, leaf impressions, shells, exoskeletons, objects preserved in amber, hair, petrified wood, oil, coal, and DNA remnants are all examples of fossils.

Fossils are commonly formed when plants or animals die in a watery environment. The remnants of the organisms are buried in mud and silt. Soft tissues quickly decompose, leaving the hard bones or shells behind. As time passes, sediment builds over the top of fossils and they harden into rock. Fossils are primarily found in sedimentary rock. Sometimes, plants and animals become buried in sediment on land, which protects them from scavengers, organic decay, or weathering. Over time, that sediment forms a layer of sedimentary rock. Fossils are usually destroyed by the processes that produce both metamorphic and igneous rock.

Geologic profiles often show fossils within specific layers. These fossils can help to identify changes in the environment where the profile is formed. Fossils of marine organisms have been found within the rock layers of mountains, indicating that the mountain range contains layers that were formed underwater.

Activity

Select geologic profiles from the web that include fossils. Ask students to determine the order of events and describe the surface environment based on the fossils in the profile.

Resources

- [Events in Earth's History](#)—list of important events
- [Time Line of Earth](#)—activity to learn about Earth's geological and evolutionary history
- [How are Dinosaur Fossils Formed?](#)—a short article with images and an accompanying video; from the Natural History Museum

Grade 6

Earth's Systems

6.ESS.5 Use evidence to explain how different geologic processes shape Earth's history over widely varying scales of space and time (e.g., chemical and physical erosion; tectonic plate processes; volcanic eruptions; meteor impacts; regional geographical features, including Alabama fault lines, Rickwood Caverns, and Wetumpka Impact Crater).

Connections to *A Framework for K–12 Science Education: Practices, Crosscutting Concepts, and Core Ideas*:**Focus for Scientific and Engineering Practice(s):**

- Constructing Explanations and Designing Solutions

Focus for Crosscutting Concept(s):

- Scale, Proportion, and Quantity
- Patterns
- Cause and Effect

Focus for Disciplinary Core Idea(s):

- Earth's Materials and Systems
- The Roles of Water in Earth's Surface Processes

Key Academic Terms:

faulting, folding, normal fault, reverse fault, strike-slip fault, karst, cavern, physical erosion, chemical erosion, subduction, divergent, convergent, uplift, meteorite impact

Safety Considerations

Please refer to the [Alabama State Department of Education Lab Safety Guidelines](#).

What are common geologic features and processes?

What is physical erosion?

What is chemical erosion?

Which features of Earth formed over short periods of time?

Which features of Earth formed over long periods of time?

Background

Geological processes have formed the features of Earth. These processes occur quickly or slowly, in an instant or over millions of years, and they can cover a small area or thousands of square kilometers. These processes can be classified as internal or external.

External processes are driven by energy from the Sun and from gravity. These processes result in hazards and resources. External processes include

- the water cycle,
- weathering,
- erosion,
- deposition,
- soil formation, and
- mass movement (such as landslides and rock falls).

Internal processes are driven by the heat of Earth's interior and include

- convection/plate tectonics; and
- the rock cycle (solidification, melting, metamorphism).

These processes result in features such as mountains, hills, valleys, canyons, river channels, bays, caves, cliffs, deltas, beaches, sand dunes, stalactites, faults and folds. Some of these features are formed over many years, while others are formed in much less time.

Erosion is a major force that shapes Earth. There are two types of erosion: physical and chemical. Physical erosion involves agents such as wind or water and results in surface features such as arches and valleys. Chemical erosion is easily demonstrated by acid rain, which occurs when water mixes with chemicals in the atmosphere to form dilute acids that dissolve rock.

Activities and Considerations

Activity 1

Follow these steps to help students become comfortable with classifying features:

1. Present images of Earth's features using classroom display.
2. Have students classify the features as the result of a fast or slow process.
3. Have students classify the features as being caused by an internal or an external process.
4. Have students identify the process responsible for each feature.
5. If the feature is the result of erosion, have students identify whether it was caused by physical or chemical erosion.
6. If the feature is the result of erosion, have students identify the agent responsible for the erosion.

Activity 2

To investigate erosion, an educator can set up a stream table for a demonstration, or student groups can build their own.

Materials:

- 2–4 books
- A plastic or foam cup
- Water
- A ruler
- A baking tray, shallow pan, or lid to a plastic container
- Tape

Directions:

1. Set up a stream table similar to the example shown in the drawing below.
2. Make sure to pack the sand tightly on the tray, leaving an empty space at the bottom of the tray.
3. Cut or poke a small hole in the bottom of the cup, facing the stream tray.
4. Fill the cup with water.
5. Observe the flow of water down the tray and through the sand.

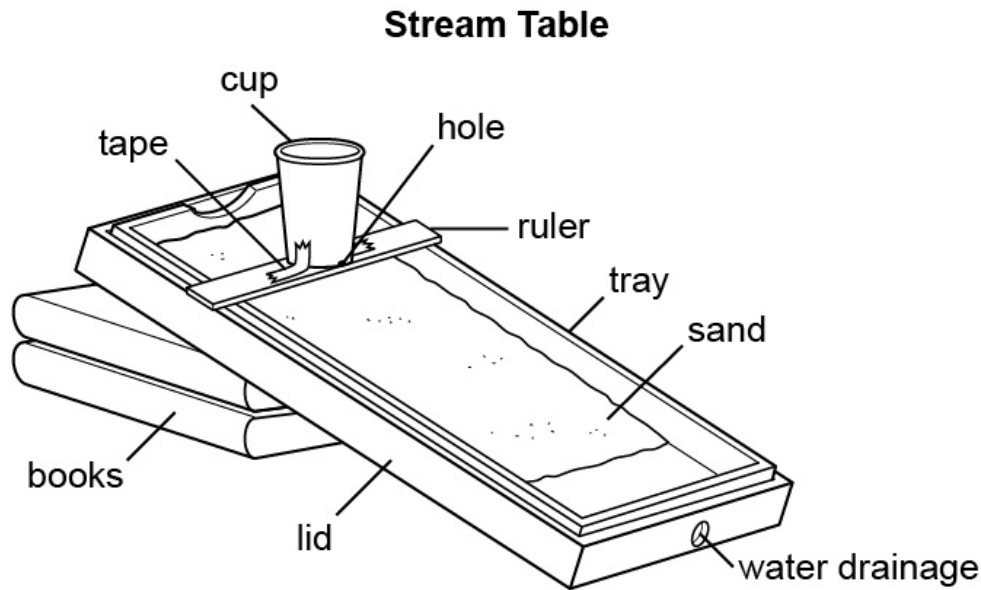

Have students make predictions and record their observations over a period of time. Water should travel through the sand, carving out a stream or series of streams. Students should observe that the water also carries sediment (sand) downhill as it travels. Point out the process of physical erosion and sedimentation that is occurring at the bottom of the tray.

Activity 3

Physical erosion can occur in many ways. Wind, water, and falling objects can break off pieces of rock, which can then be moved by geologic processes. The activity below teaches students about a few of these different kinds of physical erosion.

Materials:

- A box of chalk (any kind or color)
- A clear glass or plastic jar with a lid
- A fan

Directions:

1. Have students take 1–3 pieces of chalk and break them into $\frac{1}{2}$ inch pieces.
2. Place the chalk pieces into the jar and secure the lid.
3. Have students make observations about the appearance of the chalk pieces, which represent rocks in this activity.
4. Shake the jar vigorously for about one minute.
5. Remove the chalk pieces from the jar and have students make specific observations about their appearance. Prompt students to consider what has changed.

- a. For example, are the edges of the pieces rounded? Has there been an increase in smaller-sized chalk pieces after being shaken?
6. Place the chalk pieces on a table or a tray. Place a fan next to the chalk pieces and turn on the fan. Have students make observations about how the wind of the fan affects the chalk pieces. Then, have students connect the observed results to the natural world.

Discuss the results with the students, highlighting the physical effects of collisions and wind on the chalk pieces and how those processes relate to the erosion of rocks.

Activity 4

There are many ways to show chemical erosion. One simple activity can be done a couple of days prior to the physical erosion activity.

These are the necessary materials for the activity:

- Piece of steel wool
- A plastic container or Mason jar with a lid
- A bottle of vinegar

Follow these steps for the activity:

1. Place a piece of steel wool in the container or jar.
2. Pour vinegar into the container until the steel wool is completely submerged.
3. After 2–3 days, remove the steel wool from the container.

Have students make observations about the vinegar and steel wool, highlighting the small solid bits in the vinegar and the change in color in the steel wool or the vinegar. Discuss how chemical erosion can occur from acid rain and how this process can affect the breakdown of some rocks and the formation of limestone caves.

Considerations

Common misconceptions include the following ideas:

- Rocks do not change.
- Weathering and erosion are essentially the same thing. The two words can be used interchangeably.
- Erosion happens quickly.
- Erosion is always bad.

Resources

- [Teaching Earth Science](#)—classroom activities and lesson plans from geology.com
- [Earth Science Misconceptions](#)—common Earth science misconceptions from Teach the Earth
- [Earth Processes Misconceptions](#)— common Earth science misconceptions from Beyond Penguins and Polar Bears

How does tectonic activity affect the weathering and erosion of Earth's surface?

What are the mechanisms of plate tectonics?

What geologic features are common at tectonic plate boundaries?

How do different types of tectonic plate boundaries (divergent, convergent, subduction) affect Earth's surface?

Background

The plate tectonic theory is a fairly new concept, having been first presented in the 20th century. It is a scientific theory that describes large-scale motion of surface plates of Earth's lithosphere. It is proposed that this process began many years ago, early in Earth's history. The movement of these plates has resulted in the weathering, erosion, and deposition of each of those tectonic plates.

Tectonic plates slide across the surface of the planet due to the internal heat of Earth. Radioactive decay in the core and mantle causes the molten state of the mantle. Material at the base of the mantle is superheated on contact with the core, making this material less dense and causing it to rise within the mantle. As the material rises closer to Earth's surface, it cools, becomes denser, and sinks. At the upper surface of the mantle, the molten rock moves laterally (side-to-side), pulling tectonic plates with it. During this process, some mantle material is forced up to Earth's surface. The movement of molten material due to uneven heating is called convection. The diagram below represents this process.

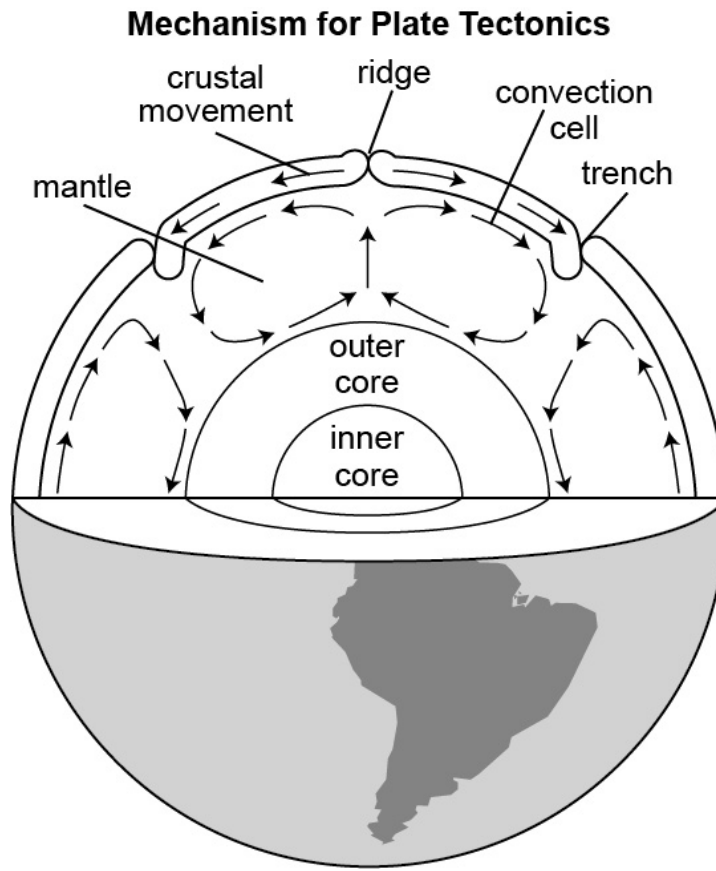

In the areas where plates pull apart, rift zones are formed. In the areas where tectonic plates collide, different features can be found. The collision of two continental plates results in mountain ranges parallel to the collision zone. When continental and oceanic plates collide, the denser of the two plates (oceanic plate) is pulled below the continental plate through the process of subduction. This results in the formation of a trench. Volcanic mountain ranges can also result from plate movements over hotspots. Hotspots in oceanic plates can result in island arcs, like the Hawaiian Islands.

Activities and Considerations

Activity 1

The process of convection can easily be demonstrated to a class. Students can also build this demonstration themselves with basic materials.

Materials:

- A large clear container or small aquarium
- Room-temperature water
- Ice cubes with blue food coloring added

- Water with red food coloring added
- 4 coffee mugs
- A heat source (e.g., hotplate, candle warmer, coffee mug warmer)
- Plastic pipette or a turkey baster

Directions:

1. Place the container on top of the coffee mugs. Each coffee mug should be under one corner of the container. Make sure the container is stable before proceeding.
2. Fill the container about halfway full with room-temperature water.
3. Place the heat source under one side of the container.
4. Place one blue ice cube on the surface of the water away from the heat source.
5. Fill the pipette or turkey baster with the red water.
6. Gently lower the pipette into the water directly above the heat source and slowly release the water at the bottom of the container.
7. Have students make observations for 2–3 minutes.

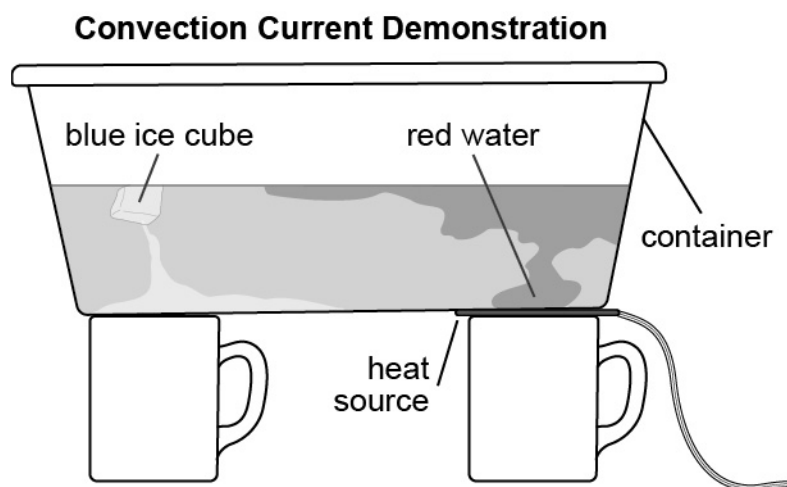

Students should observe that the blue water starts to melt and sink downward to the bottom of the bowl and that the red water warms up and rises to the top of the bowl. Discuss these observations as a class, highlighting the process of convection currents and the different densities of the two colors of water. Relate these phenomena to the processes occurring in Earth's mantle that cause the movement of Earth's tectonic plates.

Activity 2

Have students observe diagrams of various tectonic plate boundaries. Have students identify common features that form at these boundaries.

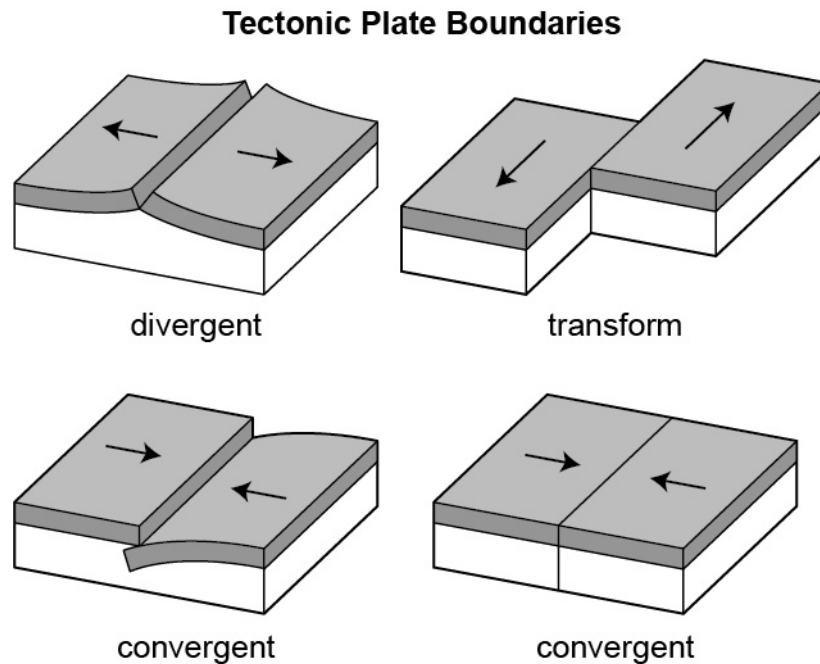

Discuss some of the features of tectonic plate boundaries with students and how different features could form as a result of Earth's internal processes. Examples of different types of tectonic plate boundaries and the features that each type creates are shown below.

- Divergent Plate Boundaries
 - Mid-ocean ridges, rift valleys, volcanoes
- Transform Plate Boundaries
 - High seismic activity, strong earthquakes
- Convergent Plate Boundaries
 - Mountains, subduction zones, volcanoes, ocean trenches

Resources

- [Teaching Earth Science](#)—classroom activities and lesson plans from geology.com
- [Earth Science Misconceptions](#)—common Earth science misconceptions from Teach the Earth
- [Earth Processes Misconceptions](#)— common Earth science misconceptions from Beyond Penguins and Polar Bears
- [Understanding Tectonic Plate Motions](#)—United States Geological Survey (USGS) instructional site

How do volcanic eruptions affect the geologic history of Earth?

What are the signs of a meteorite impact on Earth?

Is there evidence of a meteorite impact in Alabama?

Background

Volcanic eruptions are often a sudden and destructive Earth process. The molten magma ejected from volcanoes covers and destroys living organisms as well as evidence of those organisms. The igneous rock associated with volcanoes can melt the surface rock that it contacts. This causes an interruption to the geologic story of an area. Igneous intrusions are composed of magma that often does not rise to Earth's surface. Instead, magma squeezes between and through deposited rock layers. This magma can interrupt the geologic story of an area.

Meteorite impacts are another event that can cause changes to the geologic story of an area. Most meteorites that hit our planet are pebble sized and cause little damage to the planet. However, some meteorites are much larger and can cause serious damage upon impact. The craters formed by these impacts can become part of the geologic history. The largest meteoroid crater on Earth is located in Africa and is also the oldest impact site. At the point of a meteorite impact, rock at the site is deformed (melted or partially melted) and some of it is ejected into the atmosphere to eventually fall back to Earth's surface. Larger meteorites seldom impact the surface of Earth. The impact that resulted in the extinction of dinosaurs left an impact crater in the Yucatan peninsula that is 180 km in diameter. This impact released energy equivalent to about 100 million megatons of TNT. In some cases, evidence of meteorite impacts on Earth can be destroyed by the actions of plate tectonics and erosion.

The Wetumpka impact crater is located in Alabama. It is the only impact crater in the state. The meteorite that caused this crater is estimated to be 335 meters in diameter. When the meteorite hit, Alabama was covered by a shallow sea that was 90–120 meters in depth. The Wetumpka impact occurred about 83 million years ago. The walls of the impact crater have been eroded over time but are still visible. Scientists estimate that the piece of space rock that caused the crater was traveling at a speed of 6–12 kilometers per second.

Activity

Follow these steps for the activity:

1. Divide students into lab groups.
2. Provide each student with a large metal cake pan and a material to fill that pan: sand, soil, pebbles, or oatmeal. Each type of material represents a type of surface covering. Then, have students lightly sprinkle either flour or cocoa across the top of each filled pan.
3. Each group will be given a marble to represent a meteorite. For investigation 1, the meteorite should be dropped from 1 meter above the pan.
4. Students should then make observations about each group's pan. Observing each pan, students should describe the changes in the surface covering, the diameter of the crater, and the depth of the crater.
5. Students should level their pans again and sprinkle more flour or cocoa across the tops of their pans.
6. Repeat the investigation, altering only the height of the marble. Students should once again make specific observations about each group's pan.
7. Finally, students should make conclusions about how the height of the object affects the impact based on their observations.

Resources

- [Earth's 10 Biggest Impact Craters](#)—list of the 10 largest impact craters from livescience.com
- [Wetumpka Impact Crater](#)—information on the Wetumpka impact crater from Alabama travel site
- [Meteorites, Impacts, and Mass Extinctions](#)—instructional geology site from Tulane University
- [Explore! To the Moon](#)—activity on creating moon craters in the classroom

What geologic evidence of faulting and folding in Alabama can be observed?

What is karst topography?

What is a cavern and how does it form?

What are some features of Rickwood Caverns?

Background

The movement of the tectonic plates causes pressure and stress. Compressional stress results in faulting and folding. Faulting occurs when stress on rock layers overcomes the internal strength of that rock, resulting in a fracture. The San Andreas fault in California is an example of this type of rock stress. Recall that there are three types of faults: normal, reverse and strike-slip. The San Andreas fault in California is a strike-slip, or transform, fault. This type of fault is formed when two pieces of rock slide horizontally past each other. There are many earthquakes associated with the San Andreas fault zone, as well as most other fault zones.

Three major seismic zones lie near Alabama: New Madrid (a combined strike-slip and reverse fault), Southern Appalachian (which contains ancient faults that are not active), and South Carolina (which contains no faults). These three zones are shown in the map below. Seismic events, or earthquakes, are common along fault lines.

Major Seismic Zones Near Alabama

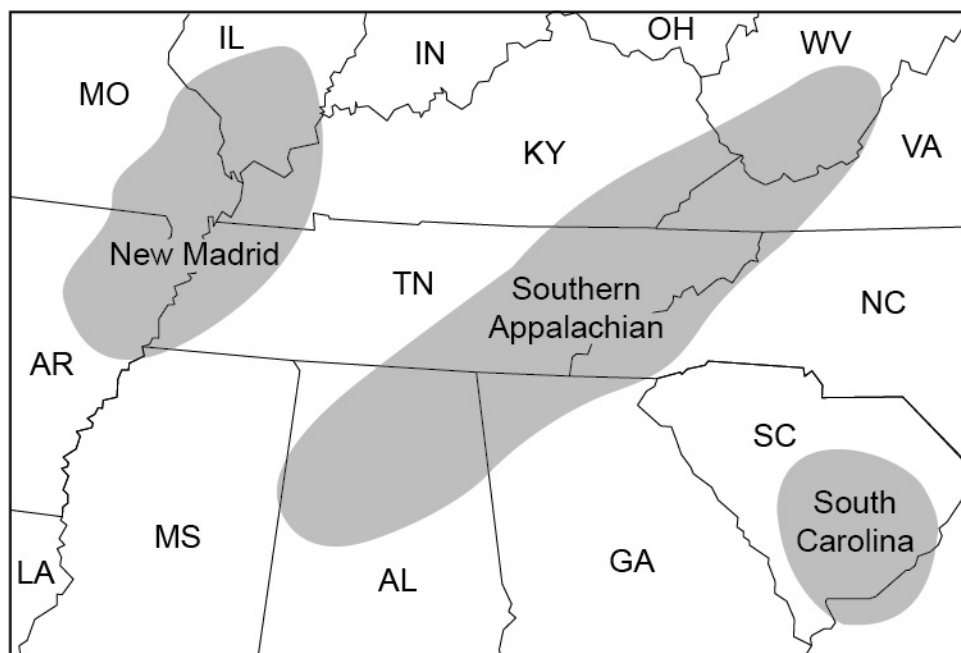

Compression can cause rocks to fold so that they are pushed upward (anticline) or downward (syncline).

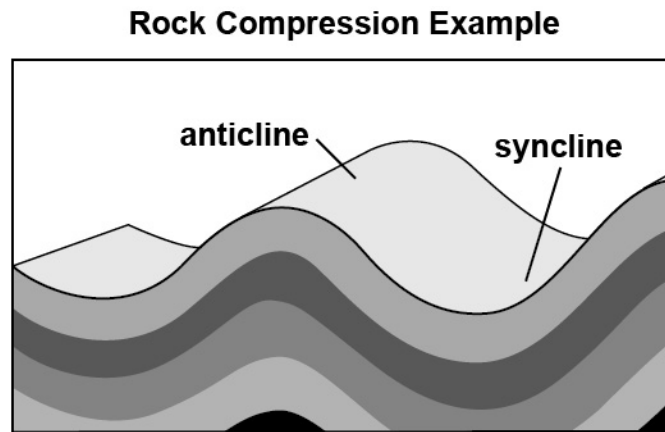

The Appalachian Mountains that extend into northwestern Alabama are folded mountains. They were formed by compression when the North American plate and the African plate collided 300 million years ago. The evidence of this compression can be seen in cross sections of the mountains.

Alabama also contains a type of landscape called karst. This landscape is underlain by limestone that has been eroded by dissolution. Because Alabama was once covered by a shallow ocean, limestone deposits are common throughout the state. Karst topography contains underground drainage systems with sinkholes, caves, and caverns. Rickwood Caverns, located in north central Alabama, is home to very old karst formations. These formations resulted from groundwater flowing through the limestone formations, eroding the rock. The groundwater dissolved some of the limestone and became acidic in the process, increasing the water's capacity to dissolve rock.

Activity

Use a graphic like the one below to show the development of a sinkhole. Have the students put a set of descriptions in order to match the dissolution of the limestone and the collapse of the surface material. Have students make claims about the effects of sinkholes that form due to the collapse of caves or caverns and discuss their ideas.

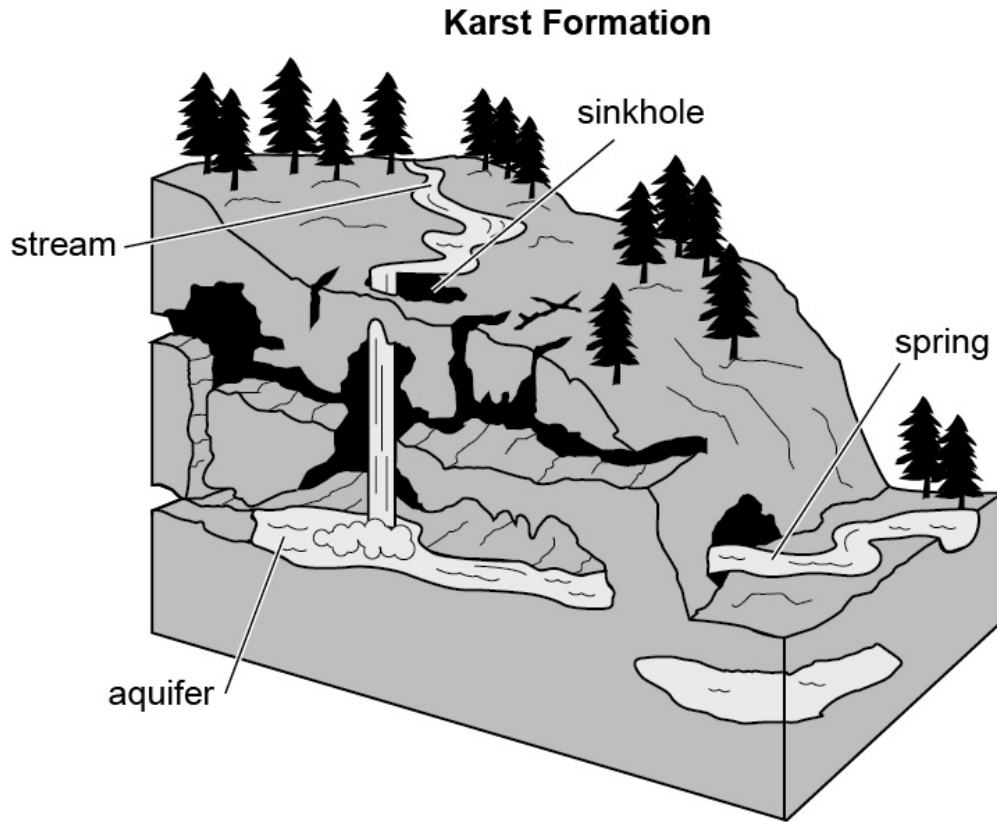

Resources

- [Folding and Faulting](#)—instructional geology site from physicalgeography.net
- [Alabama Earthquakes A](#)—news article on Alabama geology from al.com
- [Alabama Earthquakes B](#)—Geological Survey of Alabama instructional geology site the Geologic Survey of Alabama

Grade 6
Earth's Systems
6.ESS.6 Provide evidence from data of the distribution of fossils and rocks, continental shapes, and seafloor structures to explain past plate motions.

Connections to *A Framework for K–12 Science Education: Practices, Crosscutting Concepts, and Core Ideas:*

Focus for Scientific and Engineering Practice(s):

- Analyzing and Interpreting Data
- Constructing Explanations and Designing Solutions

Focus for Crosscutting Concept(s):

- Patterns
- Cause and Effect

Focus for Disciplinary Core Idea(s):

- The History of Planet Earth
- Plate Tectonics and Large-Scale System Interactions

Key Academic Terms:

Pangaea, tectonic plate, Alfred Wegener, continental drift, magnetic striping, polarity, magnetite, fossil

Safety Considerations

Please refer to the [Alabama State Department of Education Lab Safety Guidelines](#).

What is tectonic plate movement?

What is Pangaea and how is it used to illustrate tectonic plate movement?

Background

The surface of Earth is divided into tectonic plates. There are two types of tectonic plates: continental and oceanic. Oceanic plates are much denser than continental plates. Oceanic plates are primarily composed of basalt, an igneous rock. Continental plates are primarily composed of granite, an igneous rock, and limestone, a sedimentary rock. The diagram below shows the interaction of an oceanic plate and a continental plate at a subduction zone.

Interaction of Oceanic and Continental Tectonic Plates

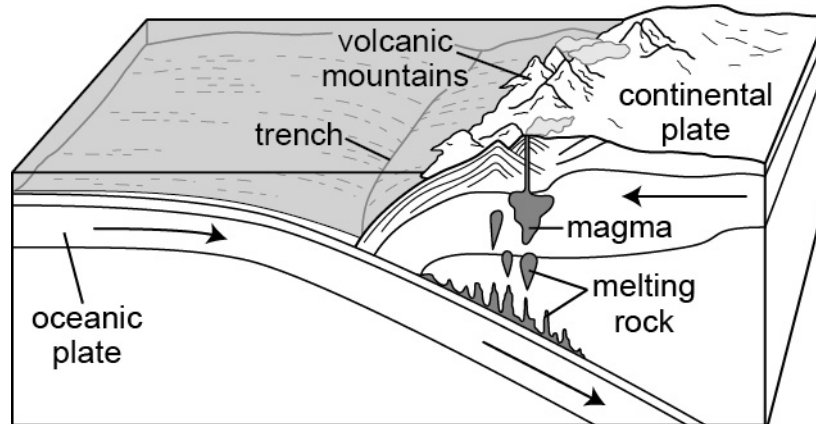

Earth’s major tectonic plates are shown in the map below.

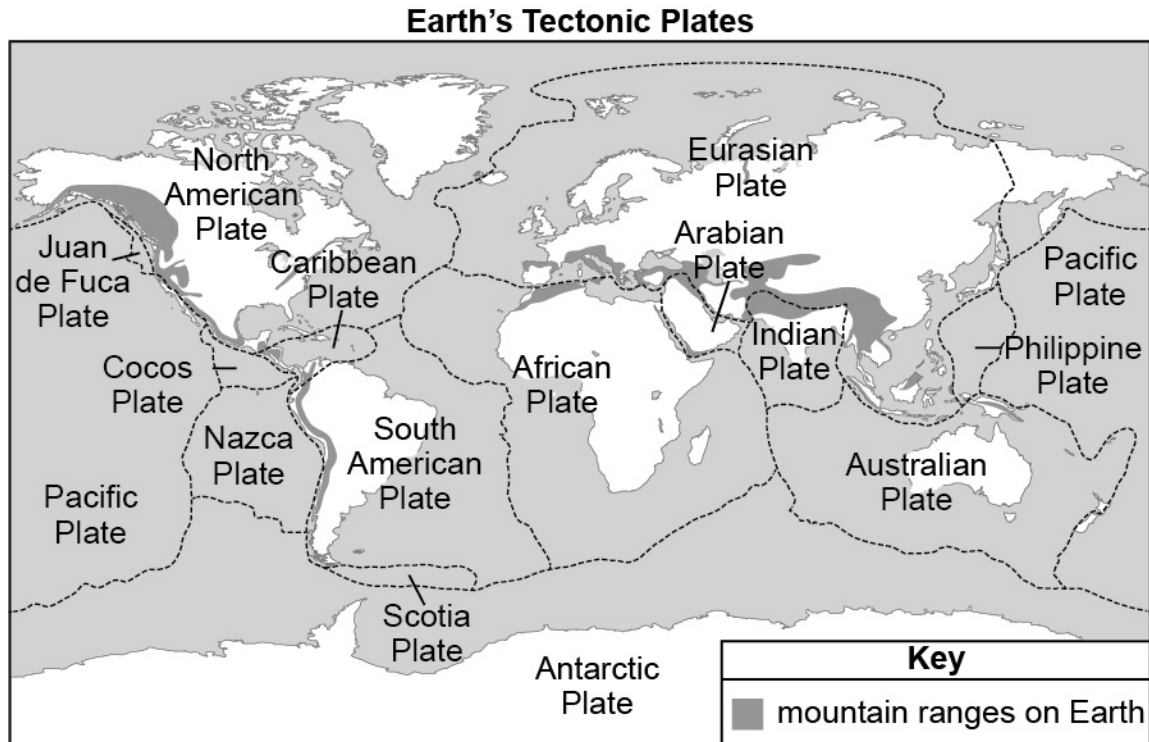

The continental plates were once joined into a supercontinent called Pangaea that existed near the equator. Pangaea was formed about 335 million years ago and began to break apart about 175 million years ago. Over time, portions of the landmass broke away and formed the continents we have today.

Changes to Earth’s Continents



Pangaea



Laurasia
Gondwana



current
continents

Earth's tectonic plates move in different directions at different types of plate boundaries.

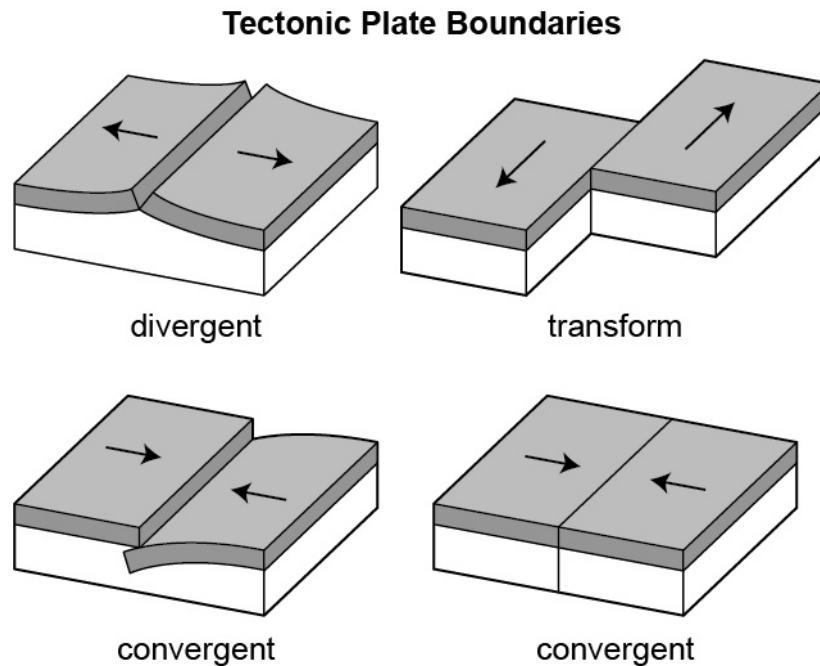

- **Divergent Plate Boundaries:** Tectonic plates diverge (separate) at these boundaries, producing new surface material on Earth's surface. Rift zones are common where two continental plates diverge, and mid-ocean ridges are common where two oceanic plates diverge.
- **Transform Plate Boundaries:** Tectonic plates slide past each other at these boundaries. However, these plates often stick together, building up energy. When the plates slip, or move, the energy is released, producing earthquakes. Strong earthquakes are common at these boundaries.
- **Convergent Plate Boundaries:** Tectonic plates converge (come together) at these boundaries. Uplift, or mountain building, occurs when two continental plates converge. Trenches and volcanic mountains form when an oceanic plate and a continental plate converge.

Activities and Considerations

Activity 1

Materials:

- Tectonic puzzle pieces (see link in “Resources” section below)
- Glue
- Scissors

Directions:

1. Provide students with tectonic plate puzzle pieces.
2. Instruct students to assemble the pieces on a separate sheet of paper.
3. Have students label the Earth’s major tectonic plates: African, Eurasian, Nazca, North American, South American, Indian, Australian, Pacific, and Antarctic.

Activity 2

There are numerous online videos that illustrate the breakup of Pangaea. Some videos are cartoons, and some are more formal. Links to three videos are provided in the “Resources” section below.

Considerations

Specific dates may be a sensitive topic for some students and families. The activities in this section can be modified to use general and/or relative dates in place of specific dates.

Common misconceptions include the following ideas:

- Only continents move.
- Most motions of Earth’s crust (especially those associated with processes of mountain building or deep-sea trench formation) are due to vertical motions, not lateral motions.
- Ocean ridges are due to vertical uplift or convergence, rather than divergence.
- Plate movement is imperceptible on a human timeframe.
- Plate motion is rapid enough that continent collision can cause financial and political chaos, while rifting can divide families or separate a species from its food source.
- The edge of a continent is the same thing as a plate boundary.
- Over time, there has been no significant change in the ratio of oceanic to continental areas.

Resources

- [Pangaea Video 1](#)—BrainPOP video on YouTube
- [Pangaea Video 2](#)—Minute Earth video on YouTube
- [Pangaea Video 3](#)— Bozeman Science video on YouTube
- [Tectonic Puzzle](#)—free printout of tectonic plate puzzle pieces
- [Plate Tectonics](#)—instructional resource from livescience.com
- [Common Misconceptions](#)—list of common Earth science misconceptions
- [Mountain Maker, Earth Shaker](#)—introduction to plate tectonics from pbs.org

How do fossils, continental shapes, seafloor structures, and rocks provide evidence of tectonic plate movement?

What is magnetic striping and how is it used to illustrate tectonic plate movement?

What geologic evidence is present in Alabama that indicates past tectonic plate movement?

Background

Alfred Wegener used a variety of evidence when he presented his hypothesis of continental drift, which later became the basis of the plate tectonic theory. Some examples of current evidence of plate tectonics include the following:

- Presence of fern fossils in Antarctica
- Puzzle-like fit of the continents
- Presence of mountain ranges on one continent that match the mountains on another continent (e.g., Antarctica and South America, eastern United States and Scandinavia, southern Africa and South America)
- Mesosaurus fossils found in South America and Africa
- Seafloor age
- Presence of volcanic activity along the Pacific Ring of Fire
- Presence of the mid-Atlantic ridge
- Magnetic reversal on the seafloor

The diagram below is a common depiction of fossil and geological evidence that is used to support the theory of past tectonic plate movement.

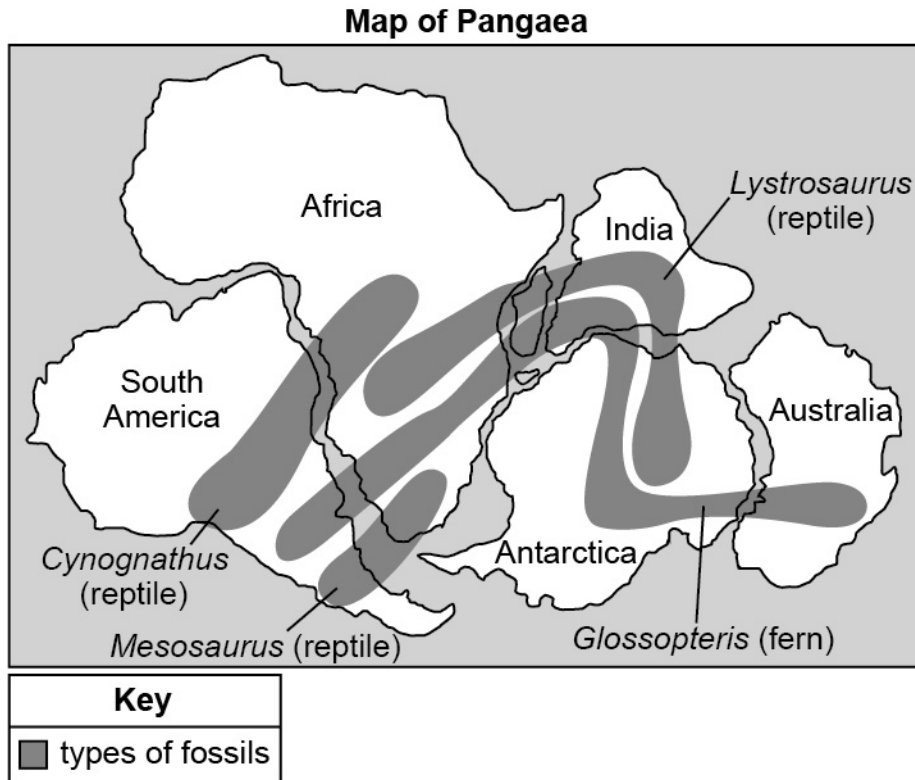

Magnetic reversals occur about every 200,000 to 300,000 years and provide proof of seafloor spreading. When these reversals happen, Earth’s magnetic field changes its polarity. This action proves the occurrence of seafloor spreading because scientists can observe the polarity of Earth’s magnetic field in rocks on the ocean floor. As magma cools, magnetic particles in it solidify in alignment with the current magnetic field. By looking at these particles, scientists can see the polarity of the magnetic field at the time the rocks were formed.

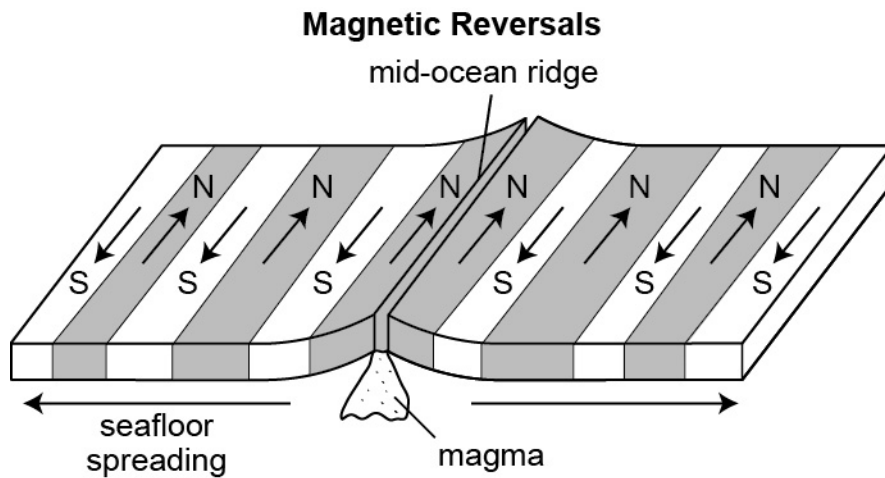

Alabama contains a variety of evidence that supports the theory of plate tectonics. Most fossils found in the state are marine fossils, which indicate that most of present-day Alabama was once covered in a shallow sea. The earthquakes that occur in the northern parts of the state are evidence of the tension and shifting forces within the continent. The presence of the Appalachians in northern Alabama reflects that pressure has resulted in the uplift of rock layers. That pressure was the result of converging plate boundaries.

Activity

This activity is designed for students to assemble the supercontinent Pangaea, as well as color-coded pieces of evidence that scientists use to support the theory of plate tectonics.

Materials:

- Pangaea puzzle pieces (see link in “Resources” section below)
- Scissors
- Glue
- Pencil
- Construction paper

Directions:

1. Cut out the puzzle pieces.
2. label each piece by its name.
3. Color the fossils and mountains with different colors to create a color code.
4. Match up the continents by matching up the fossils and mountains according to color.
5. Glue the continents onto a piece of construction paper.

Discuss the completed maps with the students. Ask the following questions to lead a discussion:

- How does continental drift work?
- Which two continents have coastlines that fit together best?
- Why don't the present shapes of continents fit together perfectly? What processes could have affected this fit?
- What does a fossil appearing on two separate land masses suggest?

Resources

- [Map of Pangaea](#)—map showing fossil and geological evidence
- [Continental Drift Activity](#)—activity to learn about Pangaea from nsta.org
- [Wegener’s Continental Drift](#)—instructional site about Alfred Wegener
- [Alabama Earthquakes](#)—news article on Alabama geology from al.com

Grade 6
Earth's Systems
6.ESS.7 Use models to construct explanations of the various biogeochemical cycles of Earth (e.g., water, carbon, nitrogen) and the flow of energy that drives these processes.

Connections to *A Framework for K–12 Science Education: Practices, Crosscutting Concepts, and Core Ideas:*

Focus for Scientific and Engineering Practice(s):

- Developing and Using Models

Focus for Crosscutting Concept(s):

- Stability and Change
- Patterns
- Energy and Matter

Focus for Disciplinary Core Idea(s):

- Earth's Materials and Systems
- The Roles of Water in Earth's Surface Processes

Key Academic Terms:

ammonia, nitrification, denitrification, water cycle, carbon cycle, nitrogen cycle, energy, recycling, carbon sink, biogeochemical cycle

Safety Considerations

Please refer to the [Alabama State Department of Education Lab Safety Guidelines](#).

How is energy essential to Earth cycles?

How can the flow of energy and matter be modeled in each of the major biogeochemical cycles?

Where does energy enter or leave the water cycle (input vs. output)?

Background

Earth is a giant science experiment. The materials for that experiment are the elements and compounds that keep life supplied with its needs. These materials are involved in cycles, which are series of steps that are regularly repeated in the same order. The three main Earth cycles are the water cycle, the carbon cycle, and the nitrogen cycle. Each of the materials in these cycles is recycled, but the energy that powers each cycle comes from the Sun. Solar energy flows into the cycles and is given off to each environment in the form of heat. That heat is replaced by our constant supply of energy from the Sun.

The water cycle, or the hydrologic cycle, is the biogeochemical cycle with which most people are familiar. The water cycle is primarily caused by the Sun. Solar energy powers this cycle by evaporating water from surface waters, such as oceans, lakes, and rivers. Other water moves from plants to the atmosphere through the process of transpiration.

Water comes to Earth's surface by precipitation. The water cycle is essentially a closed system. This means that the volume of water that is in the hydrosphere today is the same amount of water that has always been present in the Earth system.

Activities and Considerations

Activity 1

Follow these steps for the activity:

1. Review the phases of water and what is required to move from one phase to another:
 - a. Phases—solid, liquid, gas
 - b. Standard processes—condensation, evaporation, solidification, and melting
 - c. Extended processes—sublimation and deposition
2. Present students with an unlabeled version of the water cycle that shows liquid water, ice, and clouds.
3. Have students label the processes involved between each phase, identifying whether each process is an input or an output.

Activity 2

The water cycle can be easily modeled in the classroom. Directions for building a very simple water cycle model in a plastic bag are in the “Resources” section below. The following model uses materials that are inexpensive and may already be available in the classroom.

Materials:

- An aquarium, large glass bowl, or clear storage bin
- A lid for the aquarium or bowl, or plastic wrap
- A small bowl
- Ice cubes
- Clay
- Water
- Lamp

Directions:

1. Set up the water cycle demonstration as shown below.
2. If plastic wrap is used as the lid, make sure it is tight enough to support the weight of the bowl of ice cubes.
3. Turn the lamp on and have students make observations periodically for one hour.

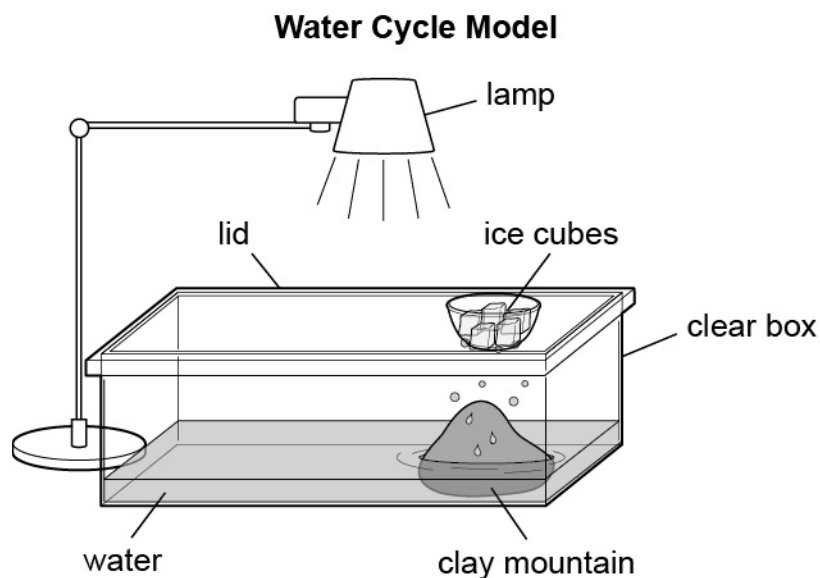

Discuss students' observations. Then, ask the following questions to lead a discussion:

1. Which parts of the water cycle represent each of the three phases of water (solid, liquid, gas)?
2. What did you observe on the bottom of the lid?
3. What caused the water to develop on the underside of the lid?
4. What function did the lamp serve in the model?

Considerations

Common misconceptions include the following ideas:

- When steam is no longer visible, it has become air.
- Water in an open container either disappears, changes into air, dries up, or is absorbed by the container.
- Condensation occurs when air turns into a liquid.
- Water only evaporates from oceans or lakes.

Resources

- [How to Make a Water Cycle in a Bag](#)—activity directions from mobileedproductions.com
- [Introduction to the Water Cycle](#)—critical thinking activity about the water cycle from NOAA
- [Common Misconceptions](#)—list of common misconceptions about states, changes of matter, and the water cycle from Beyond Penguins and Polar Bears

How are plants and animals essential to the carbon cycle?

Where can carbon be stored for long periods of time?

What is an example of a long-term carbon sink?

What is the role of bacteria in the recycling of carbon?

Background

The carbon cycle can be broken into two main parts: respiration and photosynthesis. Respiration releases carbon dioxide into the atmosphere, and photosynthesis takes carbon dioxide from the atmosphere and converts it to sugar. From those sugar molecules, the other carbon-based molecules of life can be synthesized. The diagram below represents this cycle.

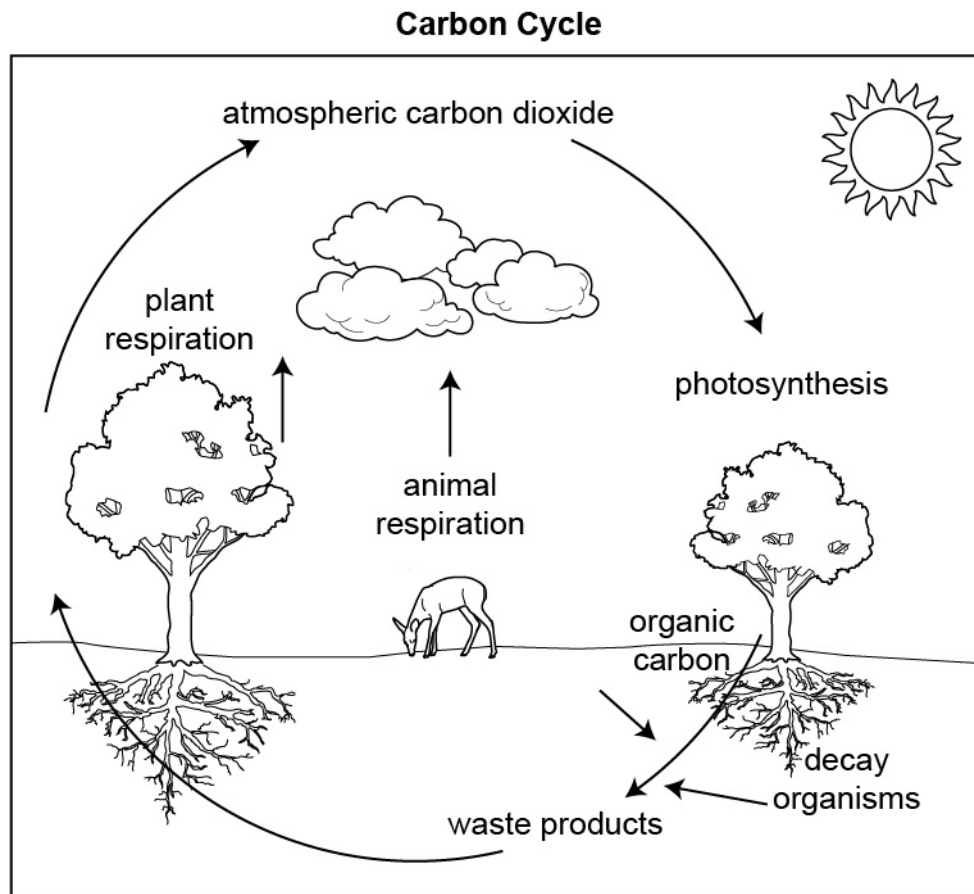

When organisms use carbon-containing matter for cellular respiration, all this matter goes back into carbon dioxide, water, and minerals, while all the energy leaves the ecosystem as heat. This is an illustration of the key scientific concept that matter cycles and energy flows through ecosystems.

Carbon is stored for long periods of time in fossil fuels or rocks. We call the long-term storage of an element a sink. On Earth, 99% of our carbon supply is in long-term reservoirs. Earth's major carbon reservoirs include the atmosphere, the terrestrial biosphere, the oceans, and sediments, which contain fossil fuels. The greatest amount of carbon is stored in Earth's oceans. Bacteria are essential to carbon storage because they decompose dead materials and produce free carbon atoms. Without bacteria, carbon would not be recycled. As well as being the backbone of the molecules that provide for life, carbon dioxide is a major contributor to the warming of our global environment.

Activity

The Dinosaur Breath Activity involves student research, experimentation, and brainstorming explanations. The link to this activity is also listed in the "Resources" section below.

Materials:

- 3–4 pieces of chalk (NOT dustless chalk)
- A rolling pin and a hard surface for crushing chalk
- 1 small plastic sandwich bag in which to crush chalk
- ¼ cup vinegar
- 2 small beakers, graduated cylinders, or small glass jars
- 1 small balloon
- 1 teaspoon baking soda
- 1 scale per group

Directions:

Please refer to the links in the "Resources" section below for directions and materials.

Resources

- [Dinosaur Breath Activity](#)—from teachengineering.org (activity directions, background reading, investigative questions, and materials list)
- [Dinosaur Breath Activity Lab sheet](#)—online PDF
- [Carbon Cycle](#)—instructional resource from apogee.net

How is atmospheric nitrogen used by organisms?

How can the flow of nitrogen be modeled in each of the major biogeochemical cycles?

Background

The nitrogen cycle is the biogeochemical cycle by which nitrogen is converted into several different chemical forms. Nitrogen is essential to all life forms, as it is found in proteins and DNA and RNA. The nitrogen cycle involves the atmosphere, the soil, and different types of organisms. The conversion of nitrogen can be carried out through both biological and physical processes.

Nitrogen makes up 78% of our atmosphere. In addition, nitrogen can transform a starch into a protein. The diagram below represents the nitrogen cycle.

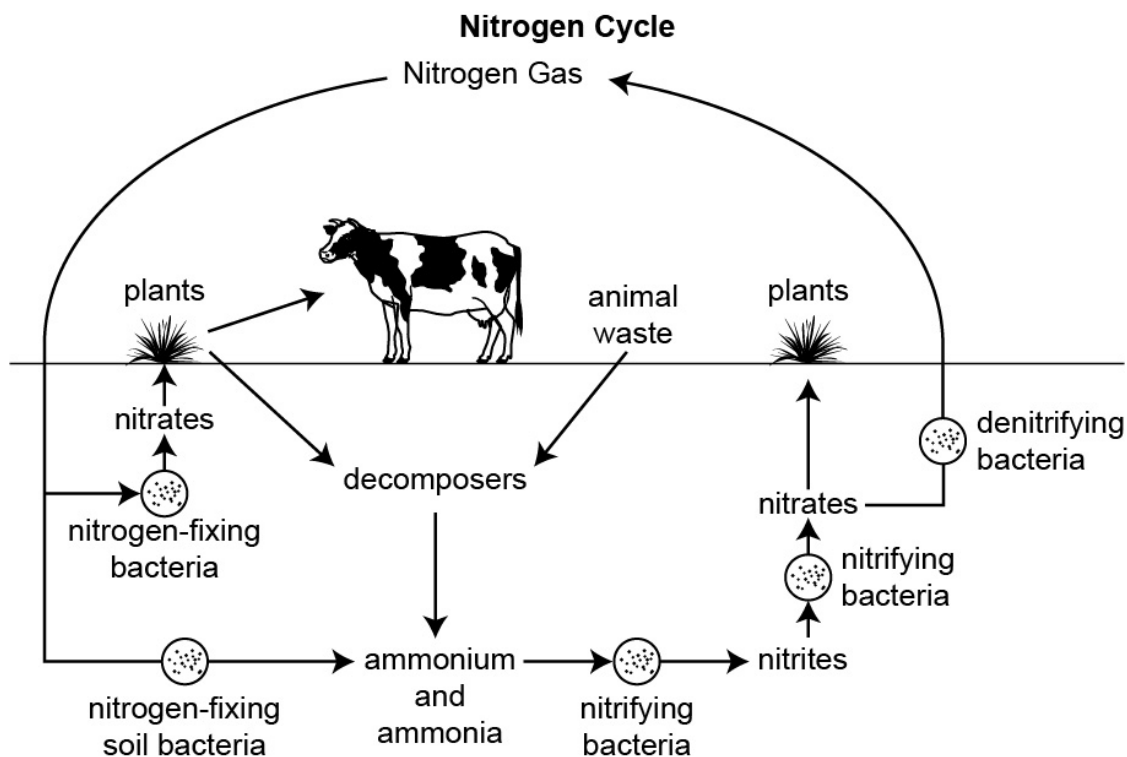

Nitrogen gas (N_2) is unusable for most organisms. Nitrogen gas must be “fixed,” or converted into a different form, through a process called nitrogen fixation. This conversion occurs in several steps, depending on the bacteria present in the soil. Once absorbed by plants, the nitrogen is used to build other molecules needed for life. Humans obtain nitrogen by eating plants and animals. The nitrogen cycle looks complex only because it requires specific groups

of bacteria to enable the individual conversions within the cycle. Death and decay of plants and animals returns nitrogen to the soil as organic nitrogen compounds.

Due to fertilizers and the growing of nitrogen-fixing crops, agriculture may be responsible for about half the nitrogen fixation on Earth. Increased nitrogen inputs (into the soil) have led to the production of more food to feed more people. Too much nitrogen, however, can cause environmental problems, such as the pollution of waterways and the production of compounds in the atmosphere that contribute to the greenhouse effect and global warming.

Resources

- [Introduction to the Nitrogen Cycle](http://sciencelearn.org)—instructional resource about the nitrogen cycle from sciencelearn.org

Grade 6

Earth's Systems

6.ESS.8 Plan and carry out investigations that demonstrate the chemical and physical processes that form rocks and cycle Earth's materials (e.g., processes of crystallization, heating and cooling, weathering, deformation, and sedimentation).

Connections to *A Framework for K–12 Science Education: Practices, Crosscutting Concepts, and Core Ideas:***Focus for Scientific and Engineering Practice(s):**

- Planning and Carrying Out Investigations

Focus for Crosscutting Concept(s):

- Energy and Matter
- Stability and Change
- Cause and Effect

Focus for Disciplinary Core Idea(s):

- Earth's Materials and Systems

Key Academic Terms:

crystallization, sediment, sedimentation, compaction, cementation, igneous rock, metamorphic rock, sedimentary rock, magma, molten rock, lava, mineralization, weathering, erosion, deformation, supersaturated solution

Safety Considerations

Please refer to the [Alabama State Department of Education Lab Safety Guidelines](#).

What are the chemical and physical processes that form rocks?

What is crystallization?

What types of rocks commonly form crystals?

Given an investigation plan, how can students experimentally determine which environmental factors affect the rate of crystallization?

How does extreme heat and pressure affect rocks?

What type of rock is formed from cooled magma?

What type of rock is formed by erosion and compaction?

How can the four processes of sedimentary rock formation (erosion, sedimentation, compaction, and cementation) be demonstrated in an investigation?

How can weathering be demonstrated in an investigation?

Background

Rocks are minerals that are stuck together. Rocks are characterized by their chemical composition and their method of formation. The composition of rocks is often determined by their method of formation.

Igneous rocks are formed by the cooling of magma, a physical process within or atop Earth's crust. They are the most common rocks at Earth's surface. Igneous rocks are often formed by the recycling of other rocks. As hot, molten rock rises to Earth's surface, changes in temperature and pressure cause it to cool, solidify, and crystallize into igneous rock.

Crystals are solid materials made of molecules that fit together in a repeating pattern. Crystals often form in nature when liquids cool and start to harden. The formation of crystals during cooling is known as crystallization. Crystals can also form by the evaporation of water from a solution. The images below represent the mineral halite and the repeating patterns of atoms that make up this mineral.

Halite Mineral

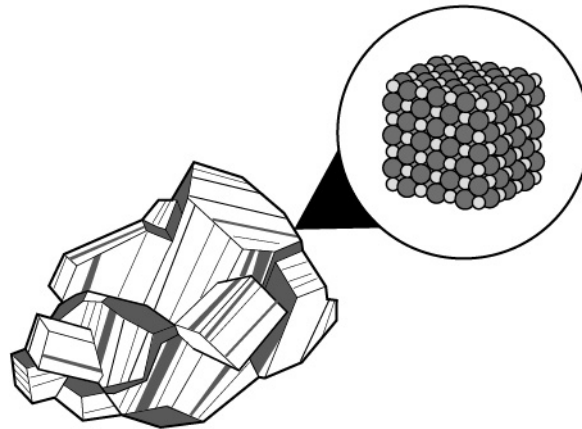

Igneous Rock

There are two types of igneous rock. Intrusive igneous rocks are those that cool slowly beneath Earth's surface. This slow cooling allows time for large crystals to form and produce a grainy texture in the rock. Granite is a common type of intrusive igneous rock. The second type of igneous rock is called extrusive, and it cools quickly above the surface of Earth. Extrusive rock forms from the lava seen flowing from a volcano. This type of rock is smooth grained, with mainly microscopic crystals. Basalt is an extrusive igneous rock and is also the most common rock at Earth's surface. Igneous rocks can also be formed by chemical changes that occur as rocks are cooling. Different minerals are formed through the different reactions that occur during cooling.

Sedimentary Rock

Sedimentary rocks form when small particles (or sediments) are accumulated and somehow cemented together. Limestone is a type of sedimentary rock that is very common in Alabama. There are two main types of sedimentary rocks: clastic and chemical. Clastic sedimentary rocks are formed from erosion, deposition, and cementation. These rocks are classified by the size of the sediments in them. Chemical sedimentary rock is chemical. These rocks are formed when dissolved minerals in water are left behind when the water evaporates.

Metamorphic Rock

Metamorphic rock is formed when igneous, sedimentary, or other metamorphic rocks are subjected to very hot temperatures (but not hot enough to melt them) and/or very high pressure. Exposure to these extreme conditions alters the minerals, texture, and chemical composition of the rocks. When two continental tectonic plates collide, the pressure of that collision results in large areas of metamorphic rock.

Rock Types

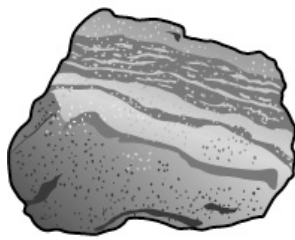

sedimentary

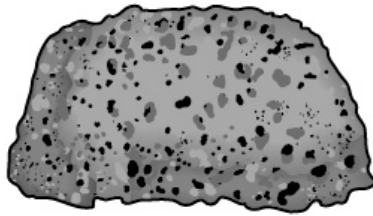

igneous



metamorphic

When combined, the formation of the three types of rocks follows the rock cycle. The energy for this cycle is supplied by gravity and heat resulting from the radioactive decay of elements in Earth’s core. Once on Earth’s surface, all rocks are subject to weathering and erosion. These processes break down rocks into smaller pieces and transport them to new locations.

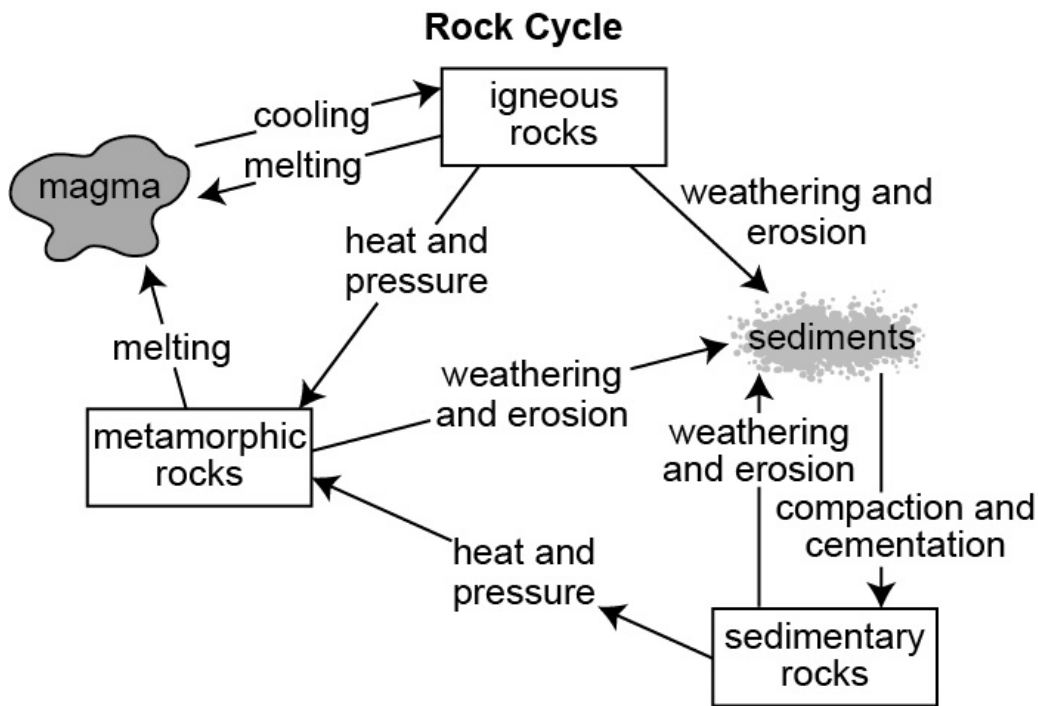

Activities and Considerations

Activity 1

This activity includes a set of videos and a large flowchart to go with the videos. Each video is about 5–6 minutes and shows many rocks, in case there is limited access to rock samples in the classroom. Each video refers to the flow chart. Provide copies of the flowchart to students before watching the videos. Students should fill out the flow chart when instructed during the videos. The links to the videos and the flow chart are included in the “Resources” section below. A smaller example of the flow chart is also shown below.

Flow Chart Example

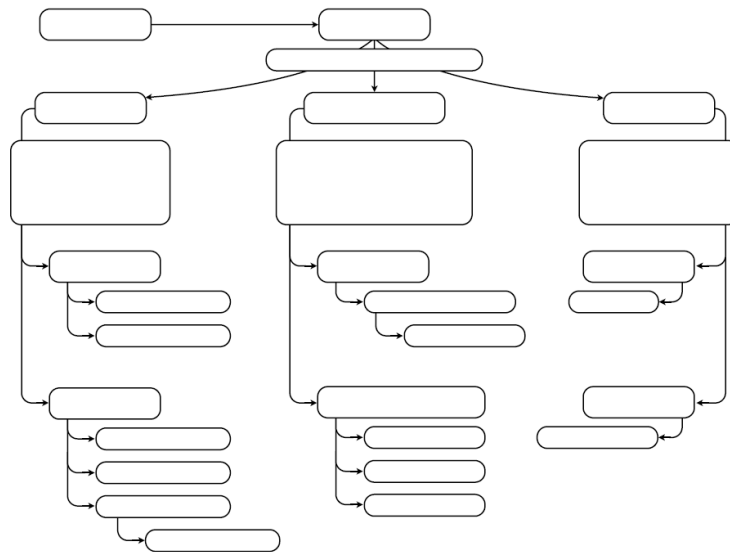

Activity 2

This activity is designed to help students describe the three major types of rock, diagram or model the rock cycle, and describe the geologic processes that form each type of rock. Complete directions are provided in the “Resources” section below.

Materials:

- Aluminum foil
- Box of crayons
- Kitchens knives
- 1 small bowl
- Hot water

- Rock cycle diagram (example provided below)
- Samples or images of sedimentary, igneous, and metamorphic rocks
 - Inexpensive rock kits can be purchased online. Photos or printouts of rocks will work as well.
- A vocabulary list (to pass out to students or display) that includes the following terms:
 - sedimentary, igneous, metamorphic, erosion, weathering, magma, rock cycle, sediment, compaction, cementation, heat, pressure, cooling

A link for the complete directions is provided in the “Resources” section below.

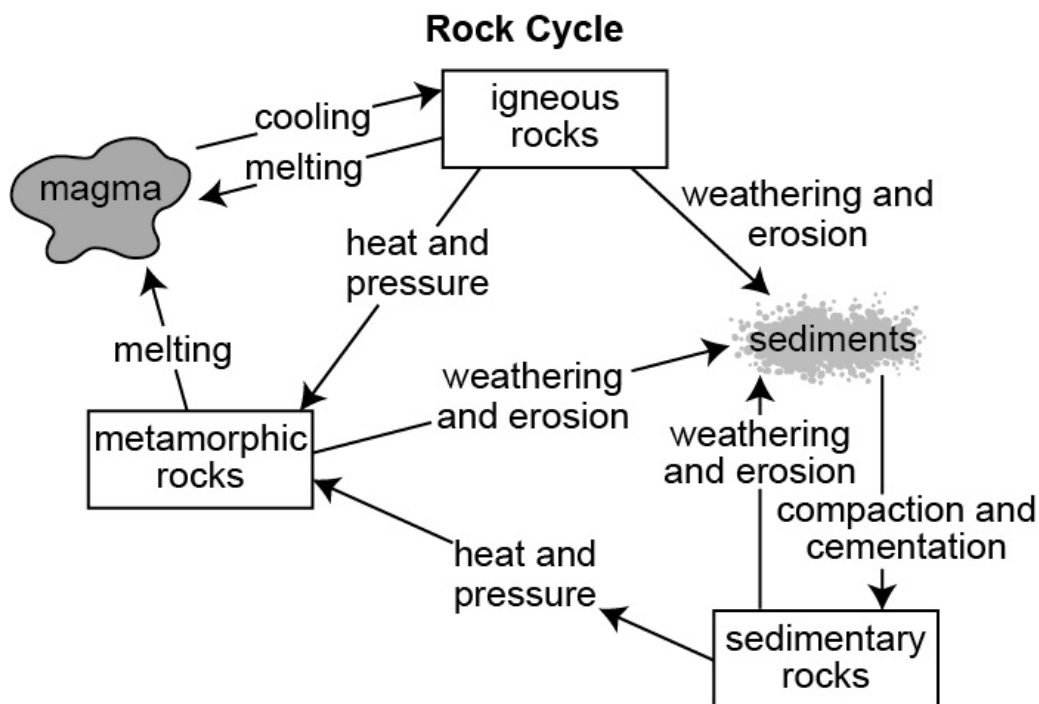

Activity 3

This investigation is designed to help students demonstrate the process by which the crystals that make up minerals are formed. There are numerous crystal formation activities available online. One example activity is provided below, and another activity is included in the “Resources” section.

NOTE: This investigation can require up to 5 days for the crystals to form completely. This length of time illustrates the prolonged process of rock formation.

Rock Candy Investigation

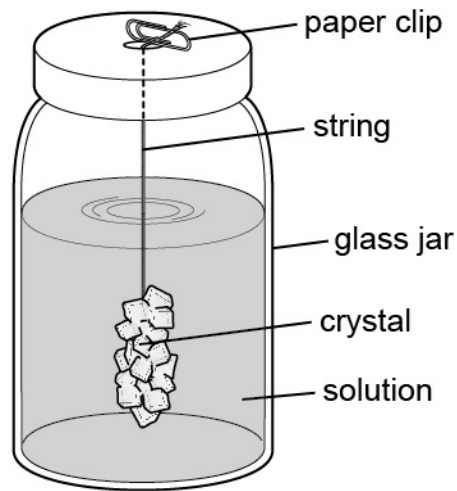

Materials:

- String
- A glass or plastic jar with lid
- Tape or paper clip
- Sugar
- Water
- A large pot

Educator Directions:

1. Cut a small hole in each of the Mason jar lids for the students.
2. Boil a large pot of water over a heat source.
3. Pour boiling water into the students' jars.

Student Directions:

1. Tie a piece of string to a paper clip.
2. Extend the string down through the hole in the jar lid so the string will hang down into the jar but does not touch the bottom. Cut off any excess string and remove it from the jar.
3. Pour about $\frac{1}{4}$ cup of sugar into the jar.
4. Once your teacher pours the boiling water into your jar, stir the mixture until the sugar dissolves.

5. Pour more sugar into the jar and mix until it dissolves.
6. Pour in additional sugar until sugar no longer dissolves in the mixture.
7. Dip the string into the mixture and roll the string in some of the sugar.
8. Let the mixture cool for 20 minutes.
9. Once the mixture has cooled, extend the string through the hole in the jar lid and secure the lid. The string should be submerged in the liquid at this point.
10. Make daily observations over the next 5 days.

Following the crystal formation, discuss the results with students. Relate the formation of crystals in their investigation to the rock cycle. Explain that the heated water provided a supersaturated solution, which means that the increased temperature of the water allowed more sugar to dissolve into liquid than would dissolve at a lower temperature. Then, when the water cooled, the excess sugar solidified and formed crystals on the string.

Considerations

Common misconceptions include the following ideas:

- Pressure causes metamorphic rocks to melt.
- All rocks are the same.
- Layered rocks are always sedimentary rocks.
- Igneous rocks can only form from sedimentary rocks.
- Igneous rocks are only found on Earth's surface.

Resources

- [Activity 1 Rock Videos](#)—selection of videos from mikesammartano.com
- [Activity 1 Flow Chart](#)—online PDF
- [Complete Directions for Activity 2](#)—MnSTEP teaching activity
- [Rock Candy](#)—instructions to make rock candy from stevespanglerscience.com
- [Classifying Sedimentary Rocks](#)—instructional resource on classifying sedimentary rocks from rocksandminerals4u.com
- [Rock Types](#)—instructional resource about rock types from learner.org
- [Formation of Igneous Rocks](#)—instructional resource on the formation of igneous rocks from universetoday.com
- [Classifying Metamorphic Rocks](#)—instructional resource on metamorphic rocks from geology.com

Grade 6

Earth's Systems

6.ESS.9 Use models to explain how the flow of Earth's internal energy drives a cycling of matter between Earth's surface and deep interior causing plate movements (e.g., mid-ocean ridges, ocean trenches, volcanoes, earthquakes, mountains, rift valleys, volcanic islands).

Connections to *A Framework for K–12 Science Education: Practices, Crosscutting Concepts, and Core Ideas:***Focus for Scientific and Engineering Practice(s):**

- Developing and Using Models

Focus for Crosscutting Concept(s):

- Energy and Matter
- Stability and Change

Focus for Disciplinary Core Idea(s):

- Earth's Materials and Systems

Key Academic Terms:

convection, mid-ocean ridge, hot spot, subduction, trench, internal energy, magma, molten rock, rift valley, convergence, divergence, radioactive decay, gravity, magma plume, transform plate boundary, earthquake, volcano

Safety Considerations

Please refer to the [Alabama State Department of Education Lab Safety Guidelines](#).

What are the major layers of Earth's interior?

How can the major layers of Earth's interior be modeled?

Background

Earth's interior is composed of three main layers: the crust, the mantle, and the core. The core is divided into the inner core and the outer core. The inner core is a solid metal ball with a radius of 1,220 kilometers. It is very dense and made primarily of iron and nickel. The inner core rotates at a rate just slightly faster than the rate of the entire planet. At a temperature of 5,400°C, the inner core is almost as hot as the surface of the Sun. The pressure in the inner core is the greatest of all Earth's layers.

The outer core is also made of iron and nickel, but it is in a molten state. This layer also contains the radioactive elements of uranium and thorium. The radioactive decay of these two elements generates a great deal of heat that is distributed in large, turbulent currents. That moving, heated material generates an electrical current that powers Earth's magnetic field. The outer core is about 2,300 kilometers in thickness and rotates in the opposite direction of the inner core.

Earth's mantle is about 3,000 kilometers thick. Iron, magnesium, and silicon are the main components of this dense, semisolid layer. Heat is distributed throughout this layer by giant convection currents that influence crustal plates that sit atop the mantle. The outermost zone of the mantle is relatively cool and rigid.

The crust is the layer of Earth with which humans are most familiar. Compared to the core and mantle, the crust is cold, brittle and very thin. Beneath the oceans, the thickness of this layer is about 5 km. The thickness of the crust beneath the continents is 30–70 km. The most common crustal elements are silica, oxygen and aluminum.

Between the upper mantle and the crust is the area that contains the giant pieces of Earth material called the tectonic plates. There are countless models of Earth's interior. The diagram below is one of these models.

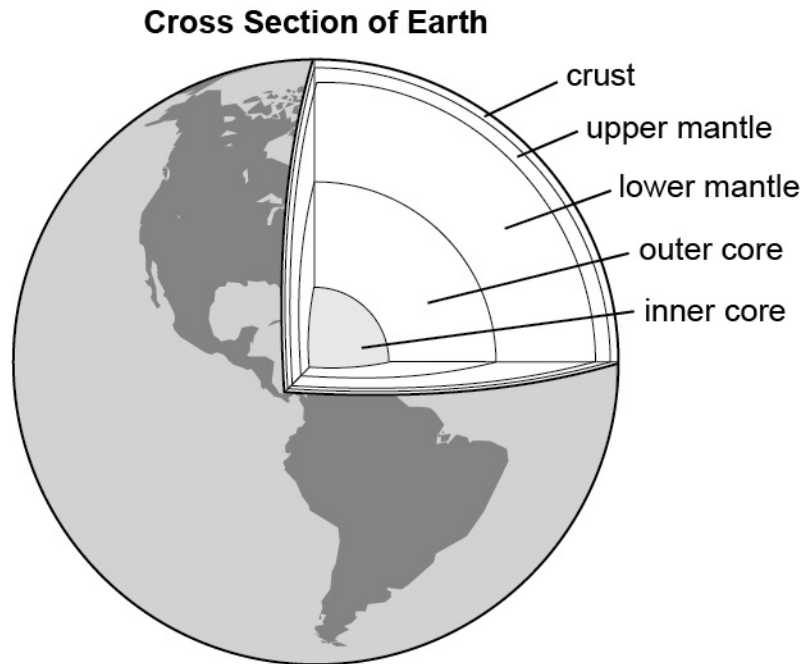

Two other terms are used to describe the internal layers of Earth: lithosphere and asthenosphere. The lithosphere is the area composed of the crust and the upper portion of the mantle. The lithosphere slides atop the asthenosphere, which is the partially molten area of the mantle beneath it. These two terms are central to the study of tectonic plate movement.

Activities and Considerations

Activity 1

An apple provides a very basic model that educators can use to introduce Earth's layers. Cut several apples in half and provide them to students. Ask students to use the apples to identify the following major layers of Earth:

- Crust
- Mantle
- Outer core
- Inner core

Apple Earth Model

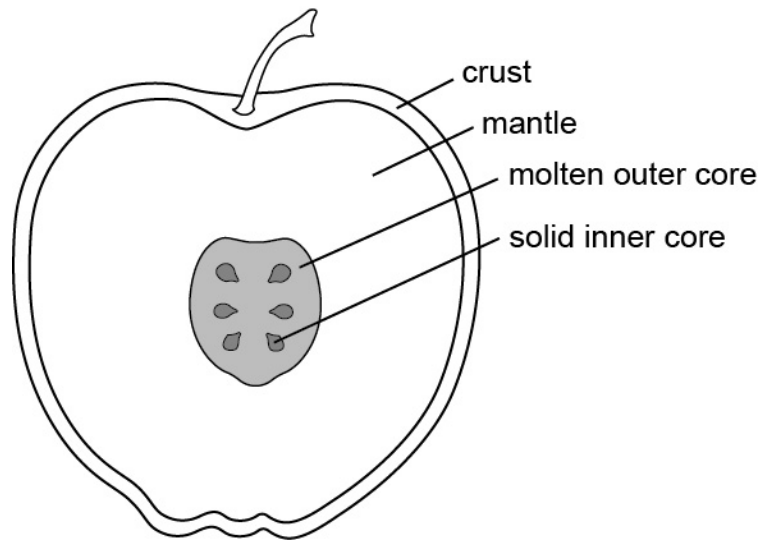

Discuss students' results and observations. Explain to students that the sections (layers) of an apple provide a general comparison to the layers of Earth. Highlight how thick Earth's crust is compared to the other layers.

Activity 2

Explain to students that they themselves are going to represent a model of Earth's layers. Each layer must be represented by at least 1 student. Give students a five-minute limit for planning and accomplishing the activity. (This is a great cooperative learning activity.)

Students should follow these instructions for the activity:

1. A single student, rotating in a circle, represents the inner core.
2. Two students represent the outer core. They surround the inner core and have turbulent movement.
3. Most of the students should make up the mantle. This layer should have circulation; therefore, multiple students should walk in a circular pattern that borders the crust.
4. Several students should represent the crust. They will likely hold hands to stay together. They should move slightly and possibly exchange positions with a mantle student every minute or so.

Considerations

Common misconceptions include the following ideas:

- Magma originates in Earth’s core.
- Earth’s core is hollow.
- Magnetic reversals can result in mass extinctions.

Resources

- [Modeling Earth’s Dimensions](#)—instructions and worksheet for students to model Earth’s dimensions from Exploring Out Fluid Earth
- [Explainer: Earth-Layer by Layer](#)—instructional resource on Earth’s interior from sciencenewsforstudents.org
- [Let’s Build the Earth](#)—activity designed to allow students to act out and represent layer of Earth from MnSTEP

What causes the internal thermal energy of Earth?

What is convection and how can it be modeled?

What causes the movement of Earth's tectonic plates?

Background

Earth is not a cold chunk of rock traveling through space. The internal layers of Earth are hot. Much of that heat remains from the formation of Earth billions of years ago. Earth has been losing very small amounts of heat since its formation. Radioactive decay of certain elements is responsible for the remainder of the heat. The topic of radioactive decay is above grade level, but the process can be simplified for discussion purposes. Radioactive decay occurs when unstable atoms change into other types of atoms. During this process, energy is released, which increases the temperature of Earth's core. This heat travels upward toward the crust.

A convection current forms when a fluid substance is heated. As the fluid substance at Earth's core becomes warmer, its molecules move faster and occupy more space. This heating process makes the substance less dense (more buoyant), causing it to rise. At the same time, the substance farthest from Earth's core is cooling, meaning its molecules move less and are more closely packed together. This cooler material is denser (less buoyant), causing it to fall back toward the core. These two combined actions create a giant circulation pattern, as shown below.

NOTE: Convection is easily observable in water, but students may not know that Earth's mantle is able to flow. Earth's mantle is not completely solid. It is a semisolid that flows several centimeters per year.

These convection currents, which are called a "convection cell" in the figure below, are essential to the movement of Earth's crust. As the current circulates beneath a tectonic plate, it acts like a conveyor belt and drags the crust and the upper part of the mantle with it. This process is sometimes called slab pull. Students should notice that the tectonic plates move in the same direction as the convection cell. Where the heat rises, magma can break through the crustal material at a ridge. Where cooled mantle material begins to sink, crustal material is recycled by being pulled into the molten mantle at a trench.

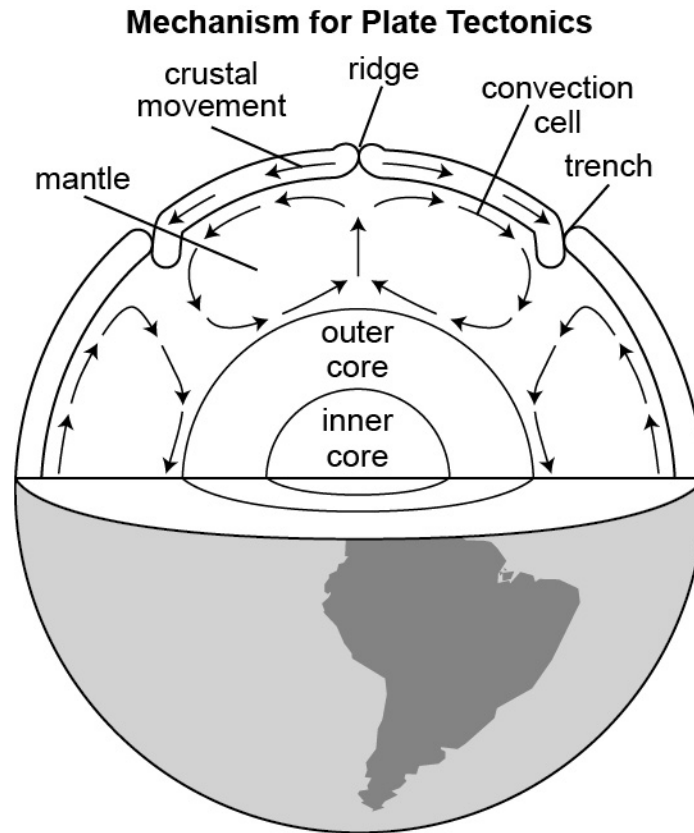

Activity

The process of convection can easily be demonstrated to a class. Students can also build this demonstration themselves with basic materials.

NOTE: Convection currents move relatively quickly in water, but they also occur in the semisolid material in Earth's mantle. The only difference is that they move much more slowly in the mantle.

Materials:

- A large clear container or small aquarium
- Room temperature water
- Ice cubes with blue food coloring added
- Water with red food coloring added
- 4 coffee mugs
- A heat source (e.g., hotplate, candle warmer, or coffee mug warmer)
- Plastic pipette or a turkey baster

Directions:

1. Place the container on top of the coffee mugs. Each coffee mug should be under one corner of the container. Make sure the container is stable before proceeding.
2. Fill the container about halfway full with room-temperature water.
3. Place the heat source under one side of the container.
4. Place one blue ice cube on the surface of the water away from the heat source.
5. Fill the pipette or turkey baster with the red water.
6. Gently lower the pipette into the water directly above the heat source and slowly release the water at the bottom of the bowl.
7. Have students make observations for 2–3 minutes.

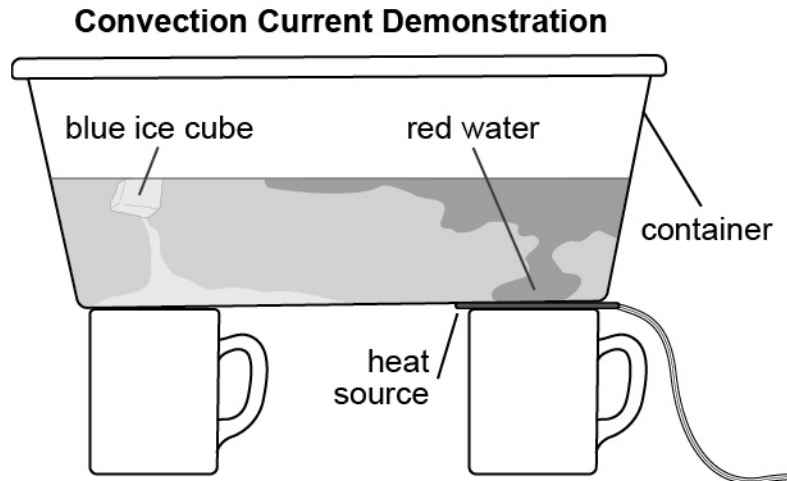

Students should observe that the blue water starts to melt and sink downward to the bottom of the bowl and that the red water warms up and rises to the top of the bowl. After several minutes, the colors will start to swirl in a circular direction. Discuss these observations as a class, highlighting the process of convection currents and the different densities of the two colors of water. Warm water rises and cool water sinks in relation to the room-temperature water. Relate these phenomena to the processes occurring in Earth's mantle that cause the movement of Earth's tectonic plates.

Resource

- [Colorful Convection Currents](#)—additional activity to demonstrate convection currents in the classroom from [stevespanglerscience.com](#)

What are the three types of plate interactions?

How can the three types of plate interactions be modeled?

What Earth features are the results of tectonic plate interactions?

What is the relationship between Earth's internal heat and mid-ocean ridges?

How can students use models to describe subduction and its effects on Earth's features?

What are hot spots, and what are their effects on Earth's features?

What event is defined by a sudden release of stored energy within Earth?

Background

Convection currents in Earth's mantle result in the interaction of the tectonic plates at Earth's surface. Tectonic plates can collide, a process known as convergence. The result of this collision is determined by the density of the colliding plates. If two continental plates with similar density collide, they usually pile upon each other and form a range of mountains. The Himalayas are a great example of this piling action. Oceanic plates have a greater density than continental plates due to the basalt in oceanic plates. When oceanic plates collide, however, they do not pile upward; instead, one plate is forced under the other. The denser plate is forced beneath the less dense plate, forming a trench. Volcanic activity is common on the less dense plate at these types of tectonic plate boundaries.

When plates diverge, or move apart, this is because they have been pushed by some force. That force is rising material from Earth's mantle. At the point where the plates are pulling apart, a rift zone is formed. A rift zone is a place where circulating mantle material is forced up through Earth's crust. There are multiple rift zones, but the largest is found near the middle of the Atlantic Ocean. Here, new crustal material is formed, pushing the two plates farther apart. Examples of tectonic plate boundaries are shown below. There are also numerous images and simulations of these plate interactions on the web.

Transform boundaries include tectonic plates that slide horizontally past each other. At these boundaries, the plates are not increasing or decreasing in size. Most transform boundaries are found moving away from a rift zone, two divergent plates. However, a few occur on land, the San Andres fault in California is a well-known example.

Tectonic Plate Boundaries

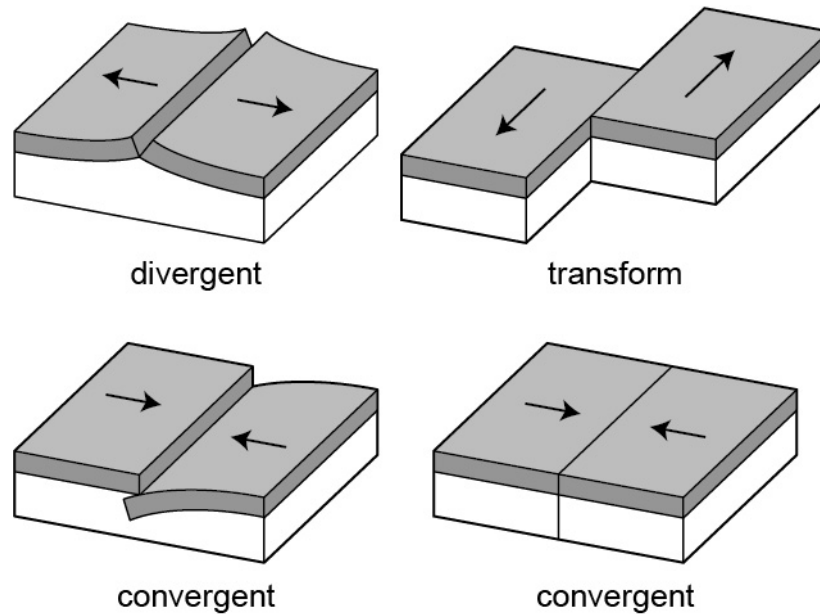

Characteristics of Tectonic Plate Boundaries:

- Divergent Plate Boundaries
 - Mid-ocean ridges, rift valleys, volcanoes
- Transform Plate Boundaries
 - High seismic activity, strong earthquakes
- Convergent Plate Boundaries
 - Mountain formation, subduction zones, volcanoes, ocean trenches

Hot spots are thin areas in Earth's crust where a large plume of molten material from the mantle rises, partially melting the lithosphere. The magma generated at a hotspot produces active volcanoes in the middle of a tectonic plate. Hotspots develop over a stationary mantle plume. As the plate moves over the hotspot, a chain of volcanoes forms. The Hawaiian Islands within the Pacific Plate is a common example.

It is possible to trace the long-term movement of a plate based on evidence of a hot spot. The Hawaiian Islands are evidence of a hotspot. By comparing the ages of the rocks formed by a hotspot, one can determine the motion of the plate above that area. A model of the formation of the Hawaiian Islands is shown below.

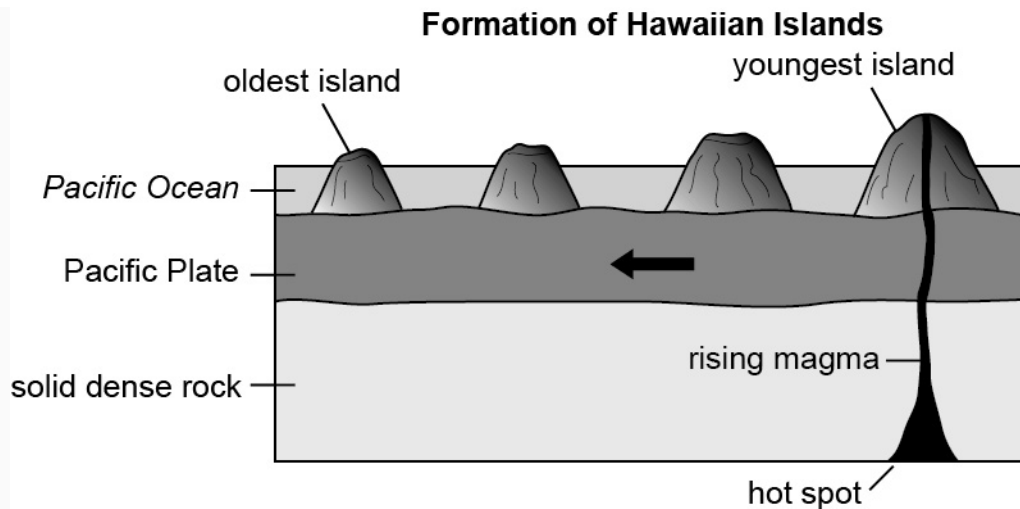

As the tectonic plates of Earth slide across the asthenosphere, they sometime become jammed. As additional pressure is applied by the motion of the plates, they often suddenly give way to continue their movement. This sudden release of energy produces an earthquake. An earthquake is defined as the shaking of the surface of Earth resulting from the sudden release of energy in Earth's lithosphere. This release produces seismic waves.

Earthquakes release different forms of energy:

- Energy in seismic waves that causes the ground to shake
- Heat energy associated with friction at the fault
- Gravitational potential energy, which is the energy stored when lifting something off the ground
- Elastic potential energy, which is similar to the recoil energy of a stretched spring

Activities and Considerations

Activity 1

This activity is designed for students to model the movement of the Hawaiian Islands and the Emperor Seamounts over time. Students should use presented data to show the progression of the Pacific plate over a hot spot. Students should be able to observe how the Pacific plate has moved over time. Necessary materials and directions for this activity are provided in a link in the “Resources” section below.

Activity 2

The NOAA offers online lessons and activities that reinforce information about mid-ocean ridges. If a computer lab is not available, a teacher can project these activities with a classroom display and have students work on them in the classroom. These activities have answer sheets that can be prepared ahead of time. Necessary materials and directions for this activity are provided in a link in the “Resources” section below.

Activity 3

This is a simple activity to demonstrate the concept of tectonic plate movements in both directions from a divergent plate boundary. Necessary materials and directions for this activity are provided in a link in the “Resources” section below.

Activity 4

This activity is designed to give students an opportunity to demonstrate principles of plate tectonics, tectonic boundary interactions, and the relative motion of faulting. Students should manipulate foam layers to demonstrate how geologic formations are created due to the interactions of surface plates. Students should observe their foam tectonic plates and make sketches with labels based on their observations. Necessary materials and directions for this activity are provided in a link in the “Resources” section below.

Activity 5

This activity is designed to give students an opportunity to build a wave box in order to investigate how energy from earthquakes can travel through a variety of materials. An example of the wave box is shown below.

Materials:

- A small cardboard box or shoebox
- String
- Paper clips

Directions for this activity are provided in a link in the “Resources” section below.

Earthquake Wave Box

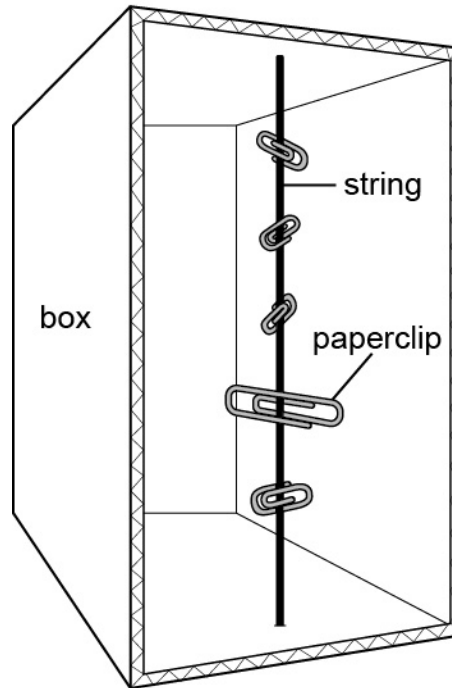

Considerations

Common misconceptions include the following ideas:

- The continents are coming back together on the other side of Earth to reform Pangaea.
- A giant meteor caused Pangaea to break apart.
- There are more plates in the Pacific than the Atlantic and that is why earthquakes and volcanoes are more common in the Pacific.
- Any mountain can become a volcano.
- Only continents (land above the oceans) move.
- The edge of a continent is the same thing as a plate boundary.
- The ground cracks open during an earthquake.

Resources

- [Activity 1 Materials and Directions](#)—online PDF
- [Activity 2 Materials and Directions](#)—NOAA
- [Activity 3 Materials and Directions](#)—perkinslearning.org
- [Activity 4 Materials and Directions](#)—purdue.edu
- [Activity 5 Directions](#)—kids-earth-science.com
- [Slip, Slide, and Collide](#)—simulation and resource about tectonic plate boundaries from learner.org

Grade 6

Earth's Systems

6.ESS.10 Use research-based evidence to propose a scientific explanation regarding how the distribution of Earth's resources such as minerals, fossil fuels, and groundwater are the result of ongoing geoscience processes (e.g., past volcanic and hydrothermal activity, burial of organic sediments, active weathering of rock).

Connections to *A Framework for K–12 Science Education: Practices, Crosscutting Concepts, and Core Ideas*:**Focus for Scientific and Engineering Practice(s):**

- Constructing Explanations and Designing Solutions

Focus for Crosscutting Concept(s):

- Cause and Effect
- Energy and Matter

Focus for Disciplinary Core Idea(s):

- Natural Resources

Key Academic Terms:

organic, natural resource, renewable, nonrenewable, fossil fuel, coal, geothermal heat, mineral, gold, diamond, groundwater, karst, limestone, calcium carbonate, aquifer, sinkhole, geyser, hot spring, extraction, depletion, research-based evidence, natural gas, petroleum, deposit, ore

Safety Considerations

Please refer to the [Alabama State Department of Education Lab Safety Guidelines](#).

What is a natural resource?

What is the link between past environments and the availability of natural resources today?

Why are some natural resources available in very limited supplies?

Which natural resources are considered renewable or nonrenewable?

Which natural resources can be replaced within a human life span?

Background

Earth is a planet that is rich with resources that were produced by the events within the Earth system. These resources are referred to as natural resources and include things like minerals, water, wood, fibers, fertile land, and any other object that can be used for economic gain. The formation of Earth and the changing conditions on our planet have been the source of these resources. Many minerals, such as diamonds and metals, are the result of the planet's internal processes. Fossil fuels are the result of plants and animals decaying and changing form beneath soil and rock over millions of years. The resources we depend on today are the results of processes that altered materials from past environments over hundreds of millions of years.

Many natural resources are in limited supply. Examples of natural resources include the following:

- **Fresh water** makes up only 2.5% of the total volume of the world's water.
- **Oil** is used to make a variety of liquid fossil fuels.
- **Natural gas** is used to heat homes.
- **Phosphorus** is a nutrient that plants need for food production.
- **Coal** is burned as a form of energy in many power plants.
- **Rare earth elements** are used in the production of computer equipment.

These resources take millions of years and very specific geological conditions to form. The distribution of natural resources depends on a variety of physical factors, such as land conditions, climate, and altitude. The distribution of these resources is unequal across the globe because these factors differ from place to place on Earth. Diamonds, for example, are found in igneous rock formations that form deep within Earth's mantle, and the depth of these

rock formations makes it difficult to mine diamonds. Rich soil is a natural resource that is degraded by weathering and can be carried away by erosion agents like wind and water.

Natural resources are classified as renewable or nonrenewable. Renewable resources are those that are used at a rate slower than the rate at which they are replaced. These include water, wind, many types of plants and trees, and sunlight. Nonrenewable resources are those that are used faster than nature can replenish them. Minerals, fossil fuels, and metal ores are all nonrenewable resources. Soil is a nonrenewable resource that is essential to producing the foods that keep humans alive.

NOTE: Students may ask about nuclear energy. This is a topic that is debated within the scientific community. Some scientists classify nuclear energy as renewable based on the amount of energy it can produce and its low carbon emissions. Other scientists classify nuclear energy as nonrenewable based on the nonrenewable resources needed to build and operate nuclear power plants.

Activity and Considerations

Activity

The purpose of this activity is to make students think about objects in their environment as being linked to natural resources and to consider whether there is a danger of losing those resources.

Materials:

- Dozens of old magazines (several for each student)
- sandwich bags (one for each student)

Directions:

1. Have each student take several magazines and cut out 10–15 pictures of specific objects they see in the pictures. Then, each student should place all their pictures in one sandwich bag. This can be done with printed online photos as well.
2. Divide students into groups. Give each group a sandwich bag full of pictures.
3. Have students make a list of the items they see in their image set.
4. Have students identify the resources used to make the items in their set.

NOTE: There may be multiple resources relevant to each image.

5. Have students determine whether these items are derived from renewable or nonrenewable resources. Students should also identify which of the resources listed are in limited supply.
6. Have students identify other resources that could be substituted for those that are in limited supply.

7. Discuss students' observations as a class. Highlight the fact that substitutions for resources are difficult. Ask students to consider the factors that affect which resources we use and why humans use nonrenewable resources.
8. Have students brainstorm resources that are available in Alabama and the geological processes that enable these resources to exist within the state.
 - a. Examples of resources in Alabama include the following: wildlife, coal, petroleum, natural gas, soybeans, peanuts, corn, iron ore, limestone, marble, trees, poultry, cotton, fresh water, plant crops, soil, and minerals.

Considerations

Common misconceptions include the following ideas:

- Population growth will cause the world to run out of all resources.
- Manufactured products are not natural.
- Earth's resources are infinite.
- Humans are not dependent upon nature.

Resources

- [Introduction to Natural Resources](#)—instructional resource from eschooltoday.com
- [Natural Resources of Alabama](#)—instructional resource from prezi.com

How are fossil fuels (coal, natural gas, and petroleum) formed?

Which past environments were essential for the production of fossil fuel deposits?

How are fossil fuels used for energy?

What are minerals and how are they formed?

What process in rock formation is associated with mineral formation?

Background

Many of the activities that humans enjoy daily are somehow linked to fossil fuels. Fossil fuels are long-carbon-chain chemicals that can be burned to harvest the energy within those molecules. Fossil fuels are a nonrenewable natural resource.

Although coal, oil, and natural gas are all different forms of fossil fuels, they are all made through similar processes. Forests, swamps, and the accumulation of sediments on the ocean floor are essential steps in the formation of fossil fuels.

The formation of coal has occurred in the following phases:

1. Ancient plants died in swamps.
2. Over millions of years, these plants were buried under dirt and water.
3. Over time, heat and pressure turned the dead plants into coal.
4. Today, humans mine for coal in areas that were once ancient forests.

Petroleum (oil) and natural gas formation has occurred in the following phases:

1. Tiny marine organisms died and were buried on the ocean floor.
2. Over millions of years, these organisms were covered by layers of silt and sand.
3. These organisms' remains were buried deeper and deeper in the ground.
4. Over time, heat and pressure turned these remains into oil and gas.
5. Today, humans drill down deep into rock formations that contain oil and natural gas deposits.

Coal Formation

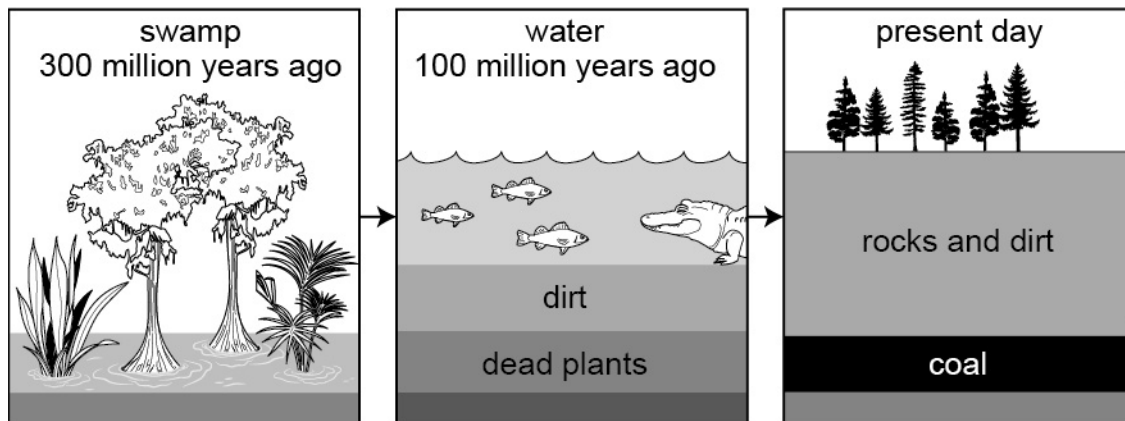

Petroleum and Natural Gas Formation

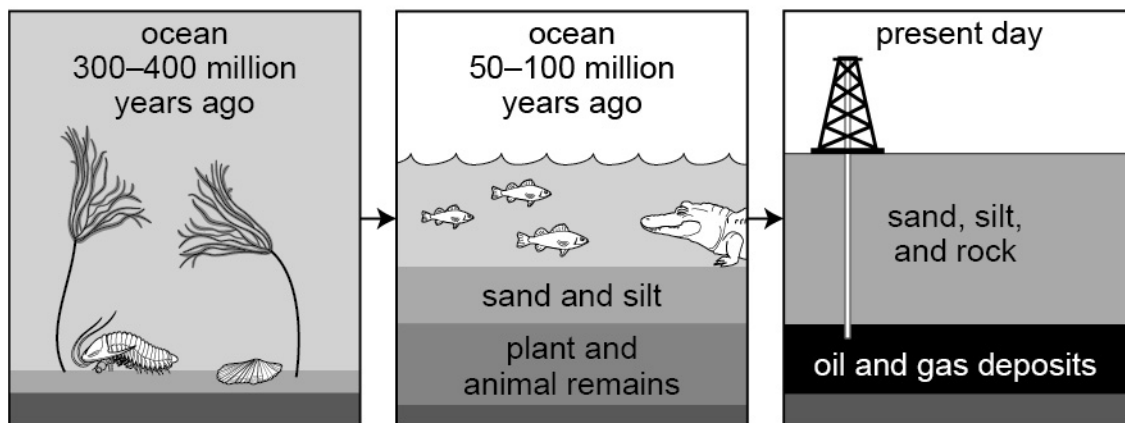

Minerals are another nonrenewable natural resource. Minerals are solid, naturally occurring inorganic (nonliving) substances with definite chemical compositions. Minerals form crystals that contain repeated arrangements of atoms. Rocks are made up of different types of minerals.

Mineral characteristics include the following:

- Minerals found in igneous rocks crystallize from molten rock.
- Minerals found in metamorphic rocks are re-crystallized from other minerals without melting.
- Minerals found in sedimentary rocks can precipitate from water.

Some common minerals are halite (salt), talc, diamond, quartz, uranium, titanium, and copper.

Activity and Considerations

Activity

This investigation is designed to help students demonstrate the process by which the crystals that make up minerals are formed. There are numerous crystal formation activities available online. One example activity is provided below, and another activity is included in the “Resources” section.

NOTE: This investigation can require up to 5 days for the crystals to form completely. This length of time illustrates the prolonged process of rock formation.

Rock Candy Investigation

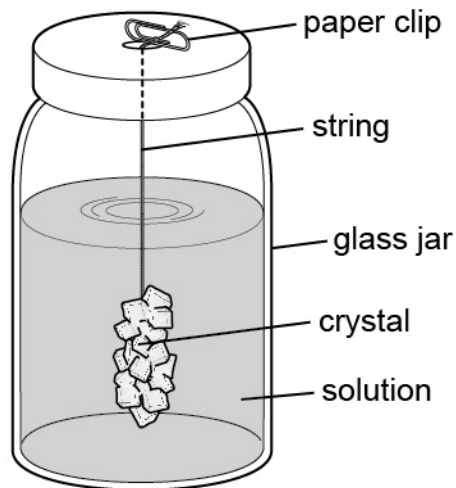

Materials:

- String
- A glass or plastic jar with lid
- Tape or paper clip
- Sugar
- Water
- A large pot

Educator Directions:

1. Cut a small hole in each of the jar lids for the students.
2. Boil a large pot of water over a heat source.

3. Pour boiling water into the students' jars.

Student Directions:

1. Tie a piece of string to a paper clip.
2. Extend the string down through the hole in the jar lid so the string will hang down into the jar but does not touch the bottom. Cut off any excess string and remove it from the jar.
3. Pour about $\frac{1}{4}$ cup of sugar into the jar.
4. Once your teacher pours the boiling water into your jar, stir the mixture until the sugar dissolves.
5. Pour more sugar into the jar and mix until it dissolves.
6. Pour in additional sugar until sugar no longer dissolves in the mixture.
7. Dip the string into solid sugar and roll the string in some of the sugar.
8. Let the mixture cool for 20 minutes.
9. Once the mixture has cooled, extend the string through the hole in the jar lid and secure the lid. The string should be submerged in the liquid at this point.
10. Make daily observations over the next 5 days.

Following the crystal formation, discuss the results with students. Relate the formation of crystals in their investigation to the rock cycle. Explain that the heated water provided a supersaturated solution, which means that the increased temperature of the water allowed more sugar to dissolve into liquid than would dissolve at a lower temperature. Then, when the water cooled, the excess sugar solidified and formed crystals on the string.

Considerations

NOTE: Specific dates in Earth's geologic history may be a sensitive topic for some students and families. Relative dates can be substituted in place of specific dates.

Common misconceptions include the following ideas:

- Rocks and minerals are the same thing.
- Humans can make rocks and minerals.
- Minerals have no significant effect on my life.

Resources

- [Rock Candy](#)—instructions to make rock candy from [stevespanglerscience.com](#)
- [Five Characteristics of a Mineral](#)—instructional resource about minerals from [sciencing.com](#)

What process or processes lead to the formation of groundwater?

Where is groundwater located on Earth and how is it accessed?

How can the extraction and use of resources by humans affect or change the distribution of these resources?

Background

Groundwater is the water found underground in the cracks and spaces in soil, sand, and rock. About 0.9% of all water on Earth is groundwater. This water is a source of recharge for lakes, rivers, and wetlands. Groundwater forms when water from Earth's surface seeps into the ground by a process called infiltration. This water moves underground through cracks and spaces in the rock and soil.

Aquifers are underground areas that store groundwater. They are not lakes but layers of sediment with spaces that can be filled with water. Areas with porous sediment layers are likely locations for aquifers. Alabama has 20 major aquifers that supply water to residents. Some of these aquifers have depths approaching 3,000 feet. 553 trillion gallons of water are stored in underground aquifers in Alabama.

Groundwater supplies are replenished, or recharged, by rain and snowmelt that seeps down into the cracks and crevices beneath the ground surface. In some areas of the world, people face serious water shortages because groundwater is used faster than it is naturally replenished. Groundwater supplies can also be polluted by human activities. Humans can access groundwater through natural springs or lakes and streams that are fed by flowing water underground. Groundwater can also be extracted through wells drilled into aquifers.

Activity and Considerations

Activity

This activity has students decide how water should be distributed.

Materials:

- 5-gallon bucket
- Large jar labeled "fresh water"
- Cup labeled "groundwater"
- Small jar labeled "rivers and lakes"
- Tablespoon
- Eyedropper

Directions for this activity are provided in a link in the "Resources" section below.

Considerations

Common misconceptions include the following ideas:

- Groundwater moves rapidly.
- Groundwater migrates thousands of miles.
- There is no relationship between groundwater and surface water.
- Groundwater removed from the ground is never returned.
- Groundwater is mysterious and occult.
- Groundwater is not a significant source of people’s water supply.

Resources

- [Activity Directions](#)—activity about the distribution of water from Groundwater Foundation
- [What is Groundwater?](#)—instructional resource on our dependence on groundwater from groundwater.org
- [Types of Aquifers](#)—basic overview of aquifers from techalive.mtu.edu
- [Alabama Aquifers](#)—groundwater information from the Geological Survey of Alabama

Grade 6

Earth's Systems

6.ESS.11 Develop and use models of Earth's interior composition to illustrate the resulting magnetic field (e.g., magnetic poles) and to explain its measurable effects (e.g., protection from cosmic radiation).

Connections to *A Framework for K–12 Science Education: Practices, Crosscutting Concepts, and Core Ideas:***Focus for Scientific and Engineering Practice(s):**

- Developing and Using Models
- Constructing Explanations

Focus for Crosscutting Concept(s):

- Cause and Effect
- Energy and Matter

Focus for Disciplinary Core Idea(s):

- Earth Materials and Systems
- Types of Interactions

Key Academic Terms:

cosmic radiation, magnetosphere, solar wind, magnetic pole, geographic pole, electric current of Earth, core composition, solar radiation, ion

Safety Considerations

Please refer to the [Alabama State Department of Education Lab Safety Guidelines](#).

What is the cause of the electric current responsible for Earth's magnetic field?

What is the magnetosphere?

How do the locations of Earth's magnetic poles compare to the locations of the geographic poles?

How can Earth's magnetic field, magnetic poles, and geographic poles be illustrated and described using a model?

Background

Earth has three distinct layers: crust, mantle, and core. The core has many important roles in the operation of the planet. The inner core is primarily solid iron. This iron is extremely hot at $5,400^{\circ}\text{C}$, but it remains solid due to the extreme pressure inside Earth. The outer core is mainly liquid iron and nickel, which is also extremely hot. However, there is less pressure in this layer, so the outer core remains liquid. Differences in temperature, pressure, and composition within the outer core result in convection currents of molten metal.

The movement of the molten iron in Earth's core results in electrical currents. Electrical currents are actually moving charges that result in magnetic fields. The electromagnet model below shows how an electrical current can produce a magnetic field.

Electromagnet Producing a Magnetic Field

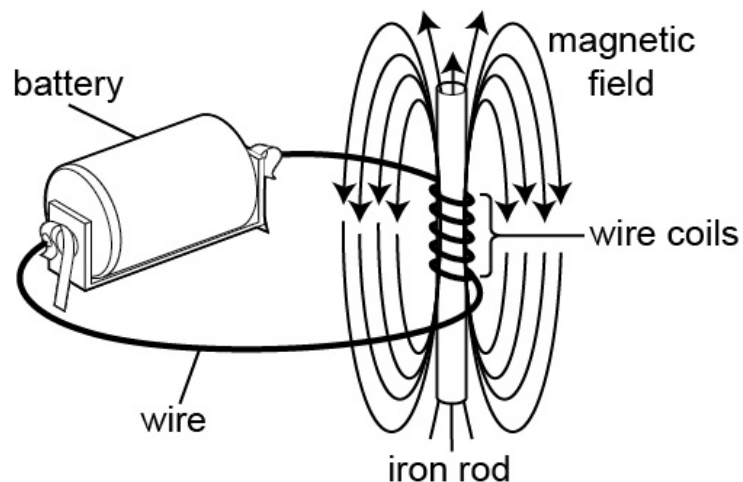

When charged, metals pass through Earth's magnetic field produce additional electrical currents. These additional electric currents, in turn, create a stronger magnetic field. This

means that this process sustains itself. This self-sustaining loop is called the geomagnetic dynamo.

Earth has a single magnetic field circling the entire planet. The model below shows the comparison between Earth's magnetic field and that of a common bar magnet.

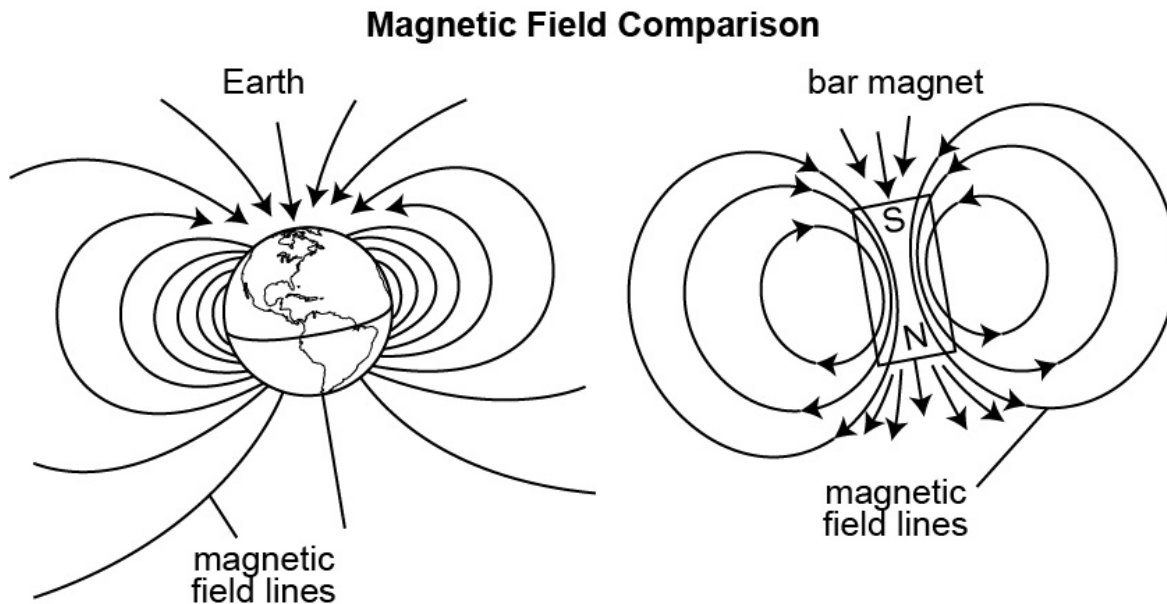

The magnetic field produced by the flowing electrical current in the outer core of Earth is extremely important to life on the planet. The area that surrounds and protects Earth with a magnetic field is called the magnetosphere. This magnetosphere shields our planet from solar and cosmic particle radiation. It also protects our atmosphere from the powerful solar wind—the constant flow of charged particles streaming off the Sun. Earth has the strongest magnetosphere of all the rocky planets.

Earth has a magnetic north pole and a magnetic south pole that correspond to the north and south poles of a magnet. Because the flow of electrons can vary, the magnetic pole location can vary. This means that the geographic and magnetic north poles are usually not at the same point on the globe. The location of the geographic north pole does not change; it is where all the lines of longitude intersect and where the axis of rotation for the planet is located. Magnetic north, however, is a wandering point where Earth's magnetic field goes vertically down into the planet, as shown in the model above. The magnetic north pole moves in loops of up to 50 miles (80 km) per day. But its actual location, an average of all these loops, also moves about 25 miles per year. In the last 150 years, the magnetic north pole has wandered a total of about 685 miles (1,102 kilometers).

Activities and Considerations

Activity 1

A teacher's guide published by Stanford University focuses on magnetism and solar activities and contains a variety of lab activities. The guide provides information on accessing materials and even how to build your own tools. Necessary materials and directions for this activity are provided in a link in the "Resources" section below.

Activity 2

Materials:

- Strong magnets (two for each group)
- Plastic wrap or plastic sandwich bags
- Iron filings
- A plastic teaspoon
- Paper or overhead transparency
- Writing utensils
- A plastic tray
- Compass

Directions:

1. Have students cover the magnets with plastic (wrap or bags) to keep iron filings from sticking to them.
2. Place the covered magnet in the plastic tray and place the paper on top.
3. Carefully use the spoon to sprinkle a small amount of the iron filings on the paper.
NOTE: The iron filings will stay in a pattern that indicates the lines of force of that magnet.
4. Have students draw their observations of the iron filings on a separate sheet of paper. The iron filings can then be poured off the paper.
5. Place 2 covered magnets about an inch apart in the plastic tray and place the paper on top.
6. Carefully sprinkle a small amount of the iron filings on the paper using the spoon.
NOTE: The iron filings will stay in a pattern that indicates the lines of force between the magnets.

7. Have students draw their observations of the iron filings on a separate sheet of paper. The students should look at the lines of force and determine whether the magnetic poles are alike or different. The iron filings can then be poured off the paper.
8. Have the students repeat steps 5–7, but this time one of the magnets should be reversed so that its opposite pole is about an inch away from the other magnet.
9. Students should look at the lines of force, determine whether the magnetic poles are alike or different, and draw their observations of the iron filings.

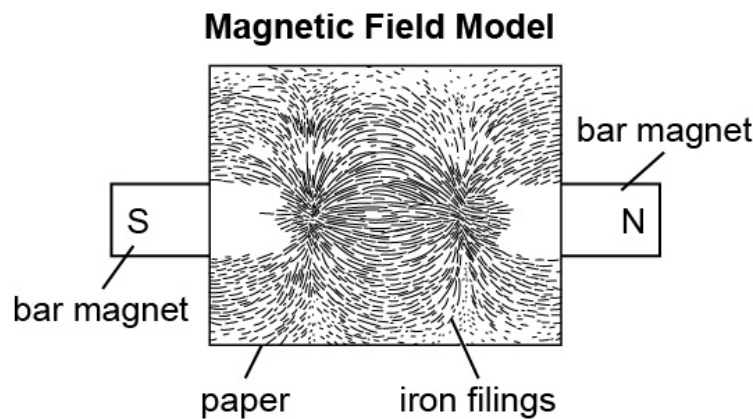

Activity 3

This activity is designed to allow students to investigate how a magnetic field is produced and to model Earth's magnetic field.

Materials:

- Magnets—strong polarity bar magnets, 1 per group
- Plastic wrap
- Iron filings
- Buttons or plastic chips
- A plastic tray or plate
- Straws—1 per student
- Safety goggles

Follow these steps for the activity:

1. Have students cover the magnets with plastic wrap to keep the iron filings from sticking to them.
2. Place a bar magnet under the plastic tray.

3. Sprinkle some iron filings onto the tray from about 10 inches away.
4. Have students observe the pattern made by the iron filings that are held in place by the forces between the opposite poles of the magnets.
5. Have students record their observations.
6. Have students softly blow through their straws towards the magnetic field lines.
7. Have students record their observations and then compare their observations to Earth's magnetosphere.
8. Have students return the iron filings to their container.
9. For the second part of the activity, place the bar magnet under a plastic or aluminum tray.
10. Place a small button directly above the center of the magnet. The button will model Earth.
11. Sprinkle the iron filings along the edge of one side of the tray.
12. Softly blow the filings toward the button through a straw.
NOTE: Depending on the force used in blowing, the filings will be trapped in the magnetic lines of force.
13. Have students record their observations. Ask students to compare their observations of the iron filings to the trapping of solar particles (from solar wind) by Earth's magnetosphere.

Considerations

Common misconceptions include the following ideas:

- Only the magnetic field of Earth protects us from the Sun's radiation.
- The solar wind and coronal mass ejections from the Sun can push a satellite out of orbit.

Resources

- [Activity 1 Materials and Directions](#)—activity from Stanford Solar Center and NASA
- [What Drives Earth's Magnetic Field?](#)—instructional resource from NOVA (pbs.org)
- [How a Planet Becomes a Magnet](#)—instructional resource from ABC Science
- [Magnetospheres](#)—instructional resource from NASA

What is solar wind and how is it produced?

How can a model describe what happens when particles from solar wind encounter the magnetosphere?

What is cosmic radiation?

How would Earth change if all cosmic radiation entered the atmosphere?

What happens to cosmic radiation when it interacts with Earth's magnetic field?

Background

Solar wind is the stream of charged particles that is released from the upper atmosphere of the Sun. These particles can escape the Sun's gravity due to their high energy. This "wind" can reach speeds as high as 900 kilometers per second and have a temperature of 1 million degrees (Celsius). Earth's magnetic field protects Earth from the particles of solar wind. The magnetosphere prevents most of these solar particles from hitting Earth. The particles that do hit Earth can damage Earth's ozone layer, which protects the planet from harmful UV radiation.

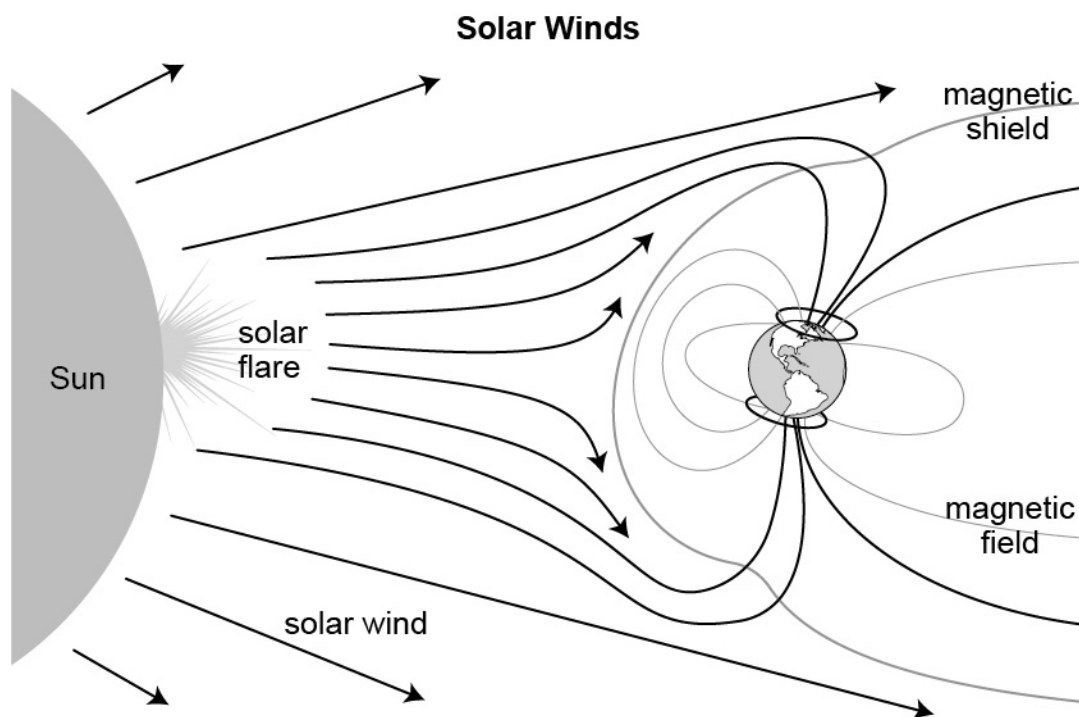

Cosmic rays (radiation) are high-energy charged particles that rain down on Earth from outside the solar system. These rays blaze at the speed of light and have been blamed for

electronics problems in satellites and other machinery. The composition of cosmic rays can provide important information about the chemical evolution of the universe. Cosmic rays are like little messengers from space; they are actual samples of star material that has traveled for millions of years before reaching Earth. Cosmic rays can also be produced by the Sun and then deflected by Earth's magnetosphere.

Activity and Considerations

Activity

This activity allows students to model Earth's magnetosphere and its protection from cosmic radiation.

Materials:

- Magnets— strong polarity bar magnets, 1 per group
- Plastic wrap
- Iron filings
- Buttons or plastic chips
- A plastic or aluminum tray
- Straws—1 per student
- Safety goggles

Procedure:

1. Place the bar magnet under a plastic or aluminum tray.
2. Place a small button directly above the center of the magnet. The button will model Earth.
3. Sprinkle the iron filings along the edge of one side of the tray.
4. Softly blow the filings toward the button through a straw.

NOTE: Depending on the force used in blowing, the filings will be trapped in the magnetic lines of force.

5. Have students record their observations of the iron filings. Ask students to compare their observations to the trapping of solar particles (from solar wind) by Earth's magnetosphere.

Consideration

A common misconception is that climate change is caused by cosmic radiation.

Resources

- [What is Solar Wind?](#)—basic overview of solar winds from space.com
- [Cosmic Rays](#)—basic overview of cosmic rays from NASA

Grade 6**Earth's Systems**

6.ESS.12 Integrate qualitative scientific and technical information (e.g., weather maps; diagrams; other visualizations, including radar and computer simulations) to support the claim that motions and complex interactions of air masses result in changes in weather conditions.

- a. Use various instruments (e.g., thermometers, barometers, anemometers, wet bulbs) to monitor local weather and examine weather patterns to predict various weather events, especially the impact of severe weather (e.g., fronts, hurricanes, tornados, blizzards, ice storms, droughts).

Connections to *A Framework for K–12 Science Education: Practices, Crosscutting Concepts, and Core Ideas:*

Focus for Scientific and Engineering Practice(s):

- Engaging in Arguments from Evidence
- Analyzing and Interpreting Data

Focus for Crosscutting Concept(s):

- Energy and Matter
- Patterns
- Cause and Effect

Focus for Disciplinary Core Idea(s):

- The Roles of Water in Earth's Surface Processes
- Weather and Climate

Key Academic Terms:

weather, climate, anemometer, thermometer, wet-bulb thermometer, barometer, air mass, ascending, descending, weather map symbols, front, humidity, hurricane, tornado, blizzard, ice storm, drought, pressure zone, altitude, atmosphere

Safety Considerations

Please refer to the [Alabama State Department of Education Lab Safety Guidelines](#).

What is weather?

What is the difference between weather and climate?

What environmental factors are used to describe the weather in an area?

How can diagrams and descriptions represent air motion in both cold and warm air masses?

What type of weather is typically associated with low- and high-pressure zones?

Background

Weather is the day-to-day state of the atmosphere, including conditions such as temperature, humidity, and wind. Climate is the average of these same conditions over a long period of time. Four major factors influence weather in any location on Earth: latitude, solar radiation, air pressure, and the amount of water present. The extreme difference in temperature between polar air and tropical air gives rise to the largest-scale atmospheric circulations.

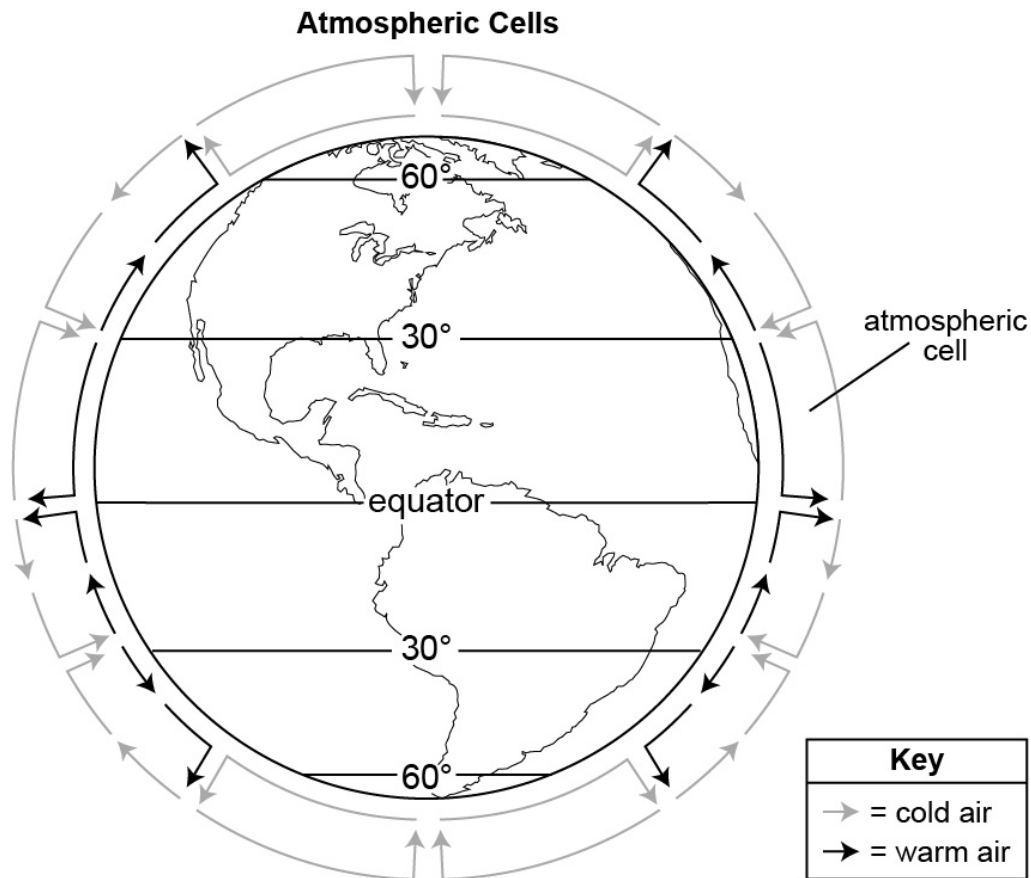

Because Earth's axis is tilted relative to the plane in which it orbits, sunlight strikes Earth at different angles at different times of the year. This sunlight affects the temperature at Earth's surface, and surface temperature differences cause pressure differences. In turn, differences in pressure pull air from one area to another across the globe. This moving air is wind, which brings with it varying levels of moisture and temperature.

There are two types of pressure systems: high pressure and low pressure.

High-Pressure Systems

A high-pressure system is characterized by dry, calm weather near its central area. High-pressure systems have a clockwise flow of dry, sinking air and are commonly found behind departing storms. High-pressure systems can be linked to the jet stream in areas where the jet stream bulges northward. The jet stream is a river of air located 5–9 miles above Earth's surface, and it can reach a speed of 250 mph.

Jet Stream Patterns on Earth

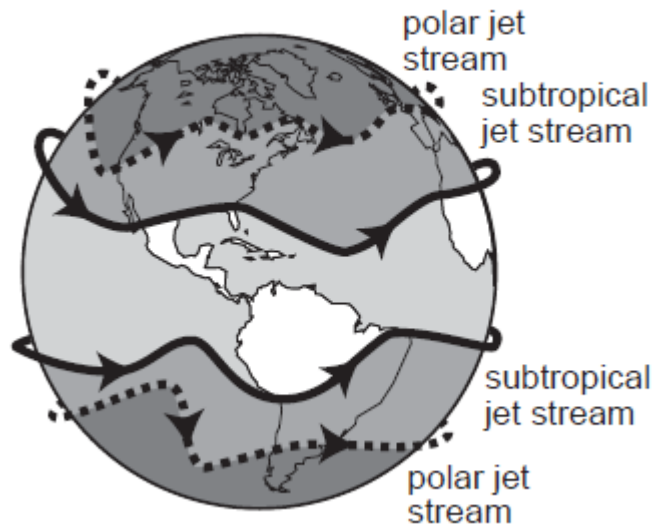

On the eastern side of a high-pressure system, winds coming out of the north generally drag colder air southward from northern latitudes. On the western side of a high-pressure system, winds blow out of the south and bring warmer air northward from more tropical climates.

Within a high-pressure system, air is forced downward, creating increased pressure at Earth's surface.

Low-Pressure Systems

A low-pressure system is the opposite of a high-pressure system. It has lower pressure at its center than the areas around it. Winds blow toward the low-pressure system, and the air rises in the atmosphere where the wind and low-pressure system meet. As the air rises, the water vapor within it condenses, forming clouds. In turn, many clouds cause precipitation.

Activity

The process of convection can be modeled to teach a variety of subjects in Earth Science. It shows the flow of denser air or water from high-pressure areas to low-pressure areas. The following activity involves a convection current in water, but the basic principles also apply to convection currents of air.

Materials:

- A large clear container or aquarium
- Room-temperature water
- Hot water
- Ice cubes with blue food coloring added
- Water with red food coloring added
- 4 coffee mugs
- Plastic pipette or a turkey baster

Directions:

1. Fill one of the coffee mugs with hot water.
2. Place the container on top of the coffee mugs. Each coffee mug should be under one corner of the container. Make sure the container is stable before proceeding.
3. Fill the container about halfway full with room-temperature water.
4. Place one blue ice cube on the surface of the water away from the heat source.
5. Fill the pipette or turkey baster with the red water.
6. Gently lower the pipette into the water directly above the coffee mug of hot water and slowly release the red water at the bottom of the container.
7. Have students make observations for 2–3 minutes.

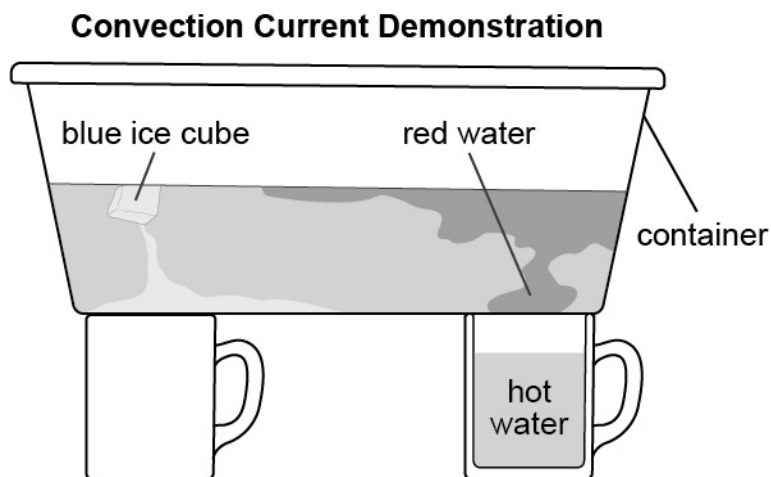

Students should observe that the blue water starts to melt and sink downward to the bottom of the bowl and that the red water warms up and rises to the top of the bowl. Discuss these observations as a class, highlighting the connection between the movement of water in this investigation to that of moving air in Earth’s atmosphere. Wind moves from high to low pressure. Cold air is denser and has a higher pressure than that of warm, less dense air.

Resources

- [What is Global Atmospheric Circulation?](#)—overview of global atmospheric circulation patterns from internetgeography.net
- [Highs and Lows of Air Pressure](#)—instructional resource from ICAR: Center for Science Education
- [The Jet Stream](#)—instructional resource from the National Weather Service (weather.gov)

What symbols are commonly included on a weather map, and how are they used?

Which types of weather are most commonly associated with warm and cold fronts?

How is a weather map used to describe and predict weather patterns?

How is regional weather affected by environmental factors (e.g., altitude, location, and topography)?

What are some identifying features of a front, a hurricane, a tornado, a blizzard, an ice storm, and a drought?

Background

Weather maps identify and plot pressure systems to predict weather. The weather map in the second graphic below shows the locations of high- and low-pressure systems and the frontal boundaries associated with those systems. High-pressure systems are labeled with “**H**” and low-pressure areas are labeled with “**L**.” High-pressure systems are associated with fair, dry weather that can develop into zones of drought. Low-pressure systems are associated with increasing clouds and precipitation.

The following is a basic weather map with standard boundary symbols.

Basic Weather Map of the United States

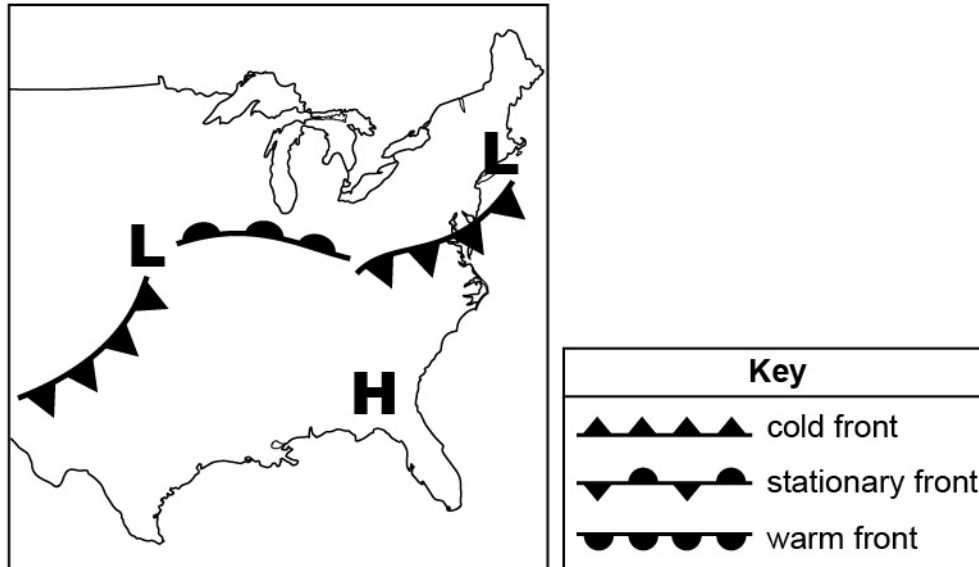

A cold front indicates that a cold air mass is replacing a warmer air mass. Cold fronts generally move from northwest to southeast. The air behind this type of front is noticeably colder and drier than the air ahead of it. Heavy rains, sometimes with hail, thunder, and lightning, commonly occur as a cold front is passing through an area.

A warm front indicates that a warm air mass is replacing a cold air mass. Warm fronts generally move from southwest to northeast, and the air behind them is warmer and moister than the air ahead of them. When a warm front passes through an area, the air becomes noticeably warmer and more humid. Fair weather with light rain usually signals the presence of a warm front.

A stationary front occurs when either a cold or warm front stops its forward movement. The opposite sides of a stationary front have different air temperatures. Because of the loss of movement of the front, large amounts of precipitation and flooding often accompany these frontal boundaries.

When a cold front overtakes a warm front, an occluded front is present. The diagrams below represent the changes in winds in three types of fronts.

Front Comparison Model

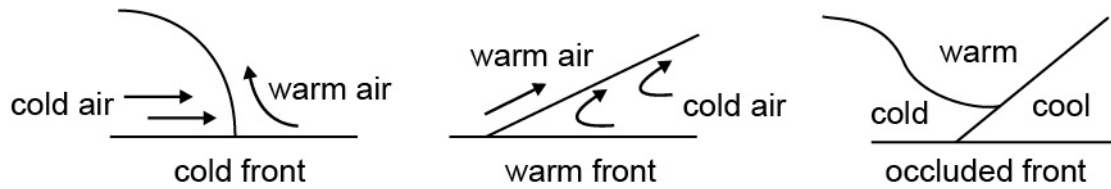

Strong winds, heavy precipitation, and tornadoes often accompany occluded fronts. When two fronts collide, weather events such as blizzards or floods can be generated.

In the United States, weather generally moves from west to east, but it can move in any direction. The reason for this general pattern of movement is a powerful river of air called the jet stream. There are multiple jet stream bands that circle the globe. The polar jet stream bands are at 50° – 60° N and S, and the tropical jet stream bands are located at 30° N and S. Warmer tropical air blows from the equator toward the colder northern regions. These winds move from west to east due to the rotation of Earth.

Atmospheric pressure, also known as barometric pressure, is usually measured in millibars. By connecting points of equal pressure, lines called isobars are formed. These isobar lines, shown on the map below, are similar to elevation lines on topographic maps. Higher numbers represent higher pressure and lower numbers represent lower pressure. Wind moves from areas of higher pressure to areas of lower pressure.

Barometric Pressure Map

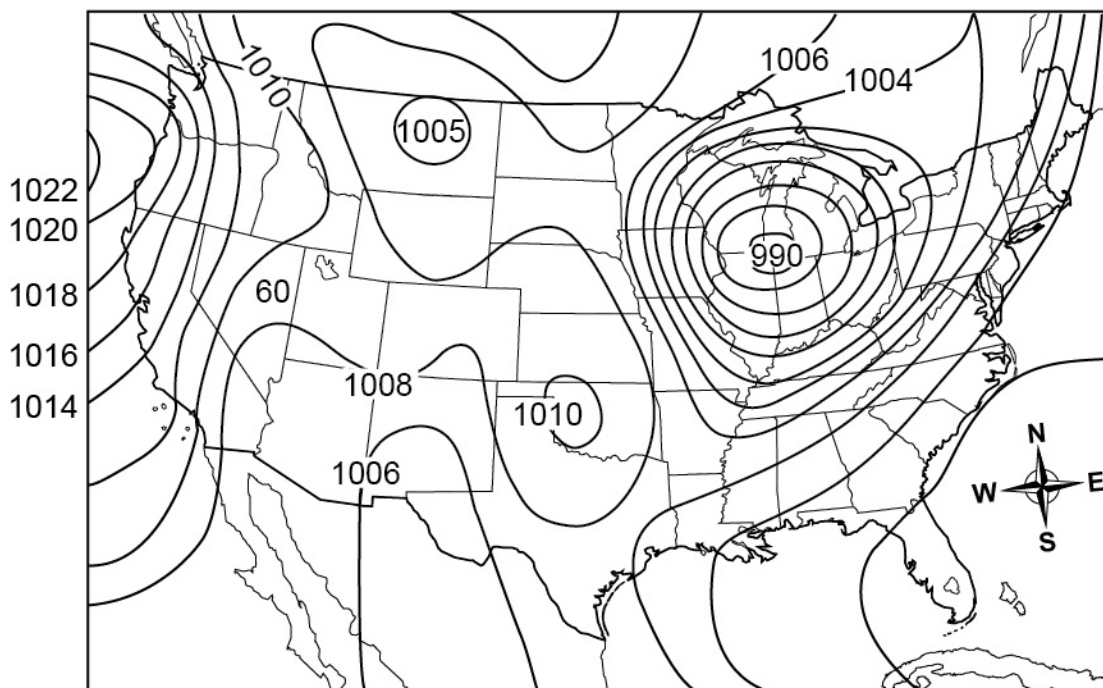

In addition to air pressure and temperature, there are environmental effects that influence both weather and climate. Altitude is one such factor. In areas of higher elevation, there is less air aloft and lower air pressure. As air pressure decreases, air molecules spread apart, and the temperature also decreases.

A second environmental factor affecting weather is location. The further from the equator a location is, the less sunlight it will receive, so the cooler the air will be. The cooler an air mass, the smaller the volume of water that can be dissolved into that air.

Topography is another factor that affects weather. Topographical features like mountains affect weather because they interrupt air currents. Ground cover and trees also affect temperature because vegetation can absorb heat. However, rocks and other solid surfaces reflect heat, drying surface soils.

Activities and Considerations

Activity 1

Follow these steps for the activity:

1. Have students bring in weather maps from local papers or bring up a local weather website on a classroom computer.
2. Project the images of weather maps and have students identify frontal boundaries, isobars, air mass directions, and likely weather for different locations.

Activity 2

This activity provides a worksheet with several questions designed to enable students to investigate and predict weather conditions based on a weather map.

Necessary materials and directions for this activity are provided in a link in the “Resources” section below.

Activity 3

NOTE: Teaching about the Coriolis Effect is not necessary for this standard. However, the following activity can serve as an extension for some students.

Background

The Coriolis Effect is a pattern of deflection that affects objects at Earth’s surface. The Coriolis Effect is based on Earth’s rotation. Earth rotates faster at the Equator than it does at the poles because the planet is wider at the Equator. Due to the rotation of Earth, air currents in the northern hemisphere, when viewed from above, appear to bend to the right, and storm systems

appear to rotate counterclockwise. In the southern hemisphere, currents are deflected to the left, and storm systems appear to rotate clockwise.

These are the necessary materials for the activity:

- Balloons (round)—1 for each pair of students
- Permanent markers (different colors that will be visible when applied to balloons)—2 for each pair of students

Students should follow these steps for the activity:

1. Students should work in pairs.
2. Blow up your balloon. With a marker, draw the equator on the balloon midway between the knot and the top of the balloon. Label the top of the balloon “north pole,” and label the knot at the bottom “south pole.”
3. Lift the balloon by the knot and hold it at eye level. Then, rotate it left to right, simulating the rotation of Earth.
4. While one partner rotates the Earth balloon, the other partner should examine the movement of Earth from the perspective of the north pole and then from the perspective of the south pole.

Make observations based on the following questions:

- a. As you look from the north pole toward the equator, is the balloon spinning clockwise or counterclockwise?
 - b. As you look from the south pole toward the equator, is the balloon spinning clockwise or counterclockwise?
5. While the first partner continues to rotate the balloon steadily from left to right, the second partner should try to slowly draw a straight line from the north pole south to the equator. While Earth continues to rotate, the first partner should use a different marker to try to draw a straight line from the south pole north to the equator.

Following the activity, the educator should use the following questions to lead a class discussion:

- What happened when you tried to draw a straight line from the north pole to the equator?
- What happened when you tried to draw a straight line from the south pole to the equator?
- What would happen if you again drew lines in the northern and southern hemispheres but with Earth rotating in the opposite direction?

Resources

- [Activity 2 Materials and Directions](#)—online PDF
- [The Coriolis Effect](#)—instructional resource from nationalgeographic.org
- [Modeling Coriolis Effect](#)—interactive website, modeling the Coriolis Effect from carolina.com
- [Weather Forecasting](#)—activity

How are different instruments used to gather data, examine patterns, and predict weather events?

What are each of the following tools used for: a thermometer, a barometer, an anemometer, and a wet-bulb thermometer?

What type of scientific data could be analyzed to predict weather conditions?

Background

A variety of tools are used to gather data about weather: thermometers measure temperature; barometers measure air pressure; sling psychrometers (a tool that has both a regular thermometer and a second thermometer with a wet cotton cover over its bulb, also called a wet-bulb thermometer) or hygrometers measure humidity; anemometers measure wind speed; weather vanes measure wind direction; rain gauges measure precipitation; and weather satellites record images of cloud cover.

By analyzing past weather conditions and applying those data to current situations, meteorologists can make accurate predictions of the weather. Using increasingly sophisticated knowledge and technology, meteorologists are often able to give people advance notice of severe weather events.

Considerations

Common misconceptions include the following ideas:

- Clouds are sponges that hold water.
- There is only lightning when there is thunder.
- Summer occurs when Earth is closest to the Sun, and winter occurs when Earth is farthest from the Sun.
- Thunder occurs when two clouds collide.
- Humid air is heavier or denser than dry air.
- Cold temperatures produce high winds.
- Polar regions only have one season.
- It snows frequently and heavily in the polar regions.

Grade 6**Earth's Systems**

6.ESS.13 Use models (e.g., diagrams, maps, globes, digital representations) to explain how the rotation of Earth and unequal heating of its surface create patterns of atmospheric and oceanic circulation that determine regional climates.

- a. Use experiments to investigate how energy from the Sun is distributed between Earth's surface and its atmosphere by convection and radiation (e.g., warmer water in a pan rising as cooler water sinks, warming one's hands by a campfire).

Connections to *A Framework for K–12 Science Education: Practices, Crosscutting Concepts, and Core Ideas:*

Focus for Scientific and Engineering Practice(s):

- Developing and Using Models
- Planning and Carrying Out Investigations

Focus for Crosscutting Concept(s):

- Systems and System Models
- Energy and Matter
- Patterns
- Cause and Effect

Focus for Disciplinary Core Idea(s):

- The Roles of Water in Earth's Surface Processes
- Weather and Climate

Key Academic Terms:

circulation, density, salinity, Coriolis effect, Hadley cell, climate, thermal layering, radiation, conduction, convection, great ocean conveyor belt, altitude, depth, atmosphere

Safety Considerations

Please refer to the [Alabama State Department of Education Lab Safety Guidelines](#).

What is density?

How does density change in the atmosphere with increasing altitude?

How does density change in the ocean with increasing depth?

How can a model be used to explain how temperature and density affect circulating air and water?

Background

Density is the amount of matter in a given volume of space. The equation for density is shown below.

$$\text{density} = \text{mass}/\text{volume}$$

For example, liquid water has a density of 1 gram/1 milliliter. Solid water, or ice, is unusual because it is less dense than liquid water, with a density of 0.9 grams/1 milliliter. However, solids are usually the densest form of matter, and gases are usually the least dense form of matter. When a material undergoes a change of state, the molecules change how they fit together.

Our atmosphere is a mixture of gases. As altitude increases, there are fewer air particles, so the air pressure decreases. If there is less pressure forcing the molecules together, the mass of air molecules in a unit of air decreases. Therefore, the density of air decreases with increasing altitude. The heat of air also affects its density. With increased temperatures, each molecule of air has more energy. The more energy a molecule has, the more it moves. So, warmer air occupies more space because the molecules are moving around more quickly. This means warmer air has a lower density than colder air.

Earth's atmosphere and its oceans are similar. The atmosphere can be considered an ocean of gas above Earth's surface. In the ocean, the deeper one dives and the farther one moves from the ocean's surface, the greater the pressure. The greater the water pressure, the more water molecules that are packed into a fixed volume. Therefore, with depth, the density of ocean water increases. The colder the water, the less each molecule moves, so the tighter the molecules are packed together. Therefore, cold ocean water is denser than warm ocean water. The model below shows how temperature affects molecular motion. Notice that as the temperature increases, the movement of the water molecules increases, resulting in the molecules taking up more space. Like air, water's density affects how it moves. Denser water sinks below less dense water.

Effects of Temperature on Molecular Motion

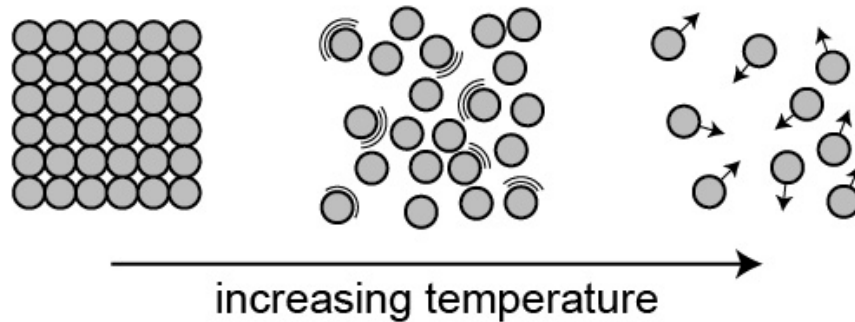

In the atmosphere, dense air sinks, while less dense air rises. This is easily demonstrated by the circulation of air near a large body of water, such as the ocean. During the day, the land heats faster than the water. Air near the surface of the land is heated by radiation and conduction. The air molecules increase their motion and occupy more space. The low-density air mass rises, and cooler air near the surface of the ocean moves in to take the place of the rising air. Water can absorb a great deal of heat before it changes temperature, so the air over the ocean stays cool. During the day, people stay cool on the beach because there is a nearly constant cool breeze coming off the ocean. At night, the land cools more quickly than ocean water. Therefore, the air over the land becomes denser and sinks. The air over the ocean is now less dense than the air over the land. This means the breeze now blows from the land toward the ocean. The diagrams below model these changes in air density and air movement and show the development of ocean breezes and land breezes.

Land and Sea Breezes

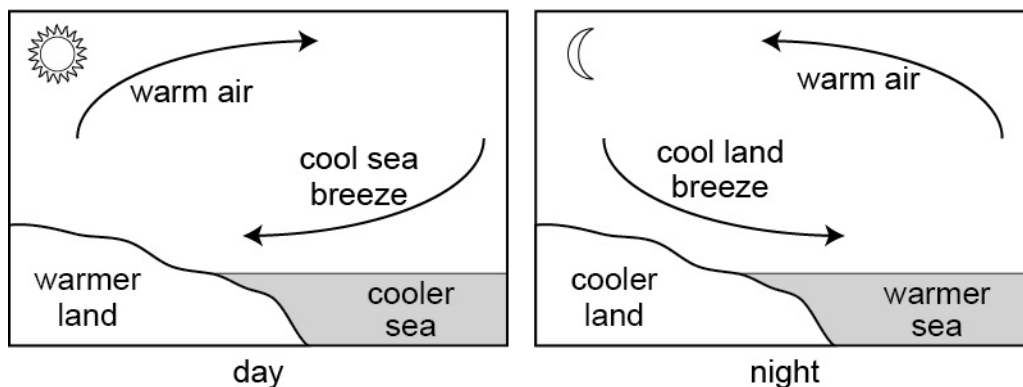

In ocean waters, cold, dense water sinks beneath warmer water. This produces water movement similar to a conveyor belt. Less dense water moves to the ocean surface and cold, denser water sinks to the ocean floor.

Global Ocean Conveyor Belt

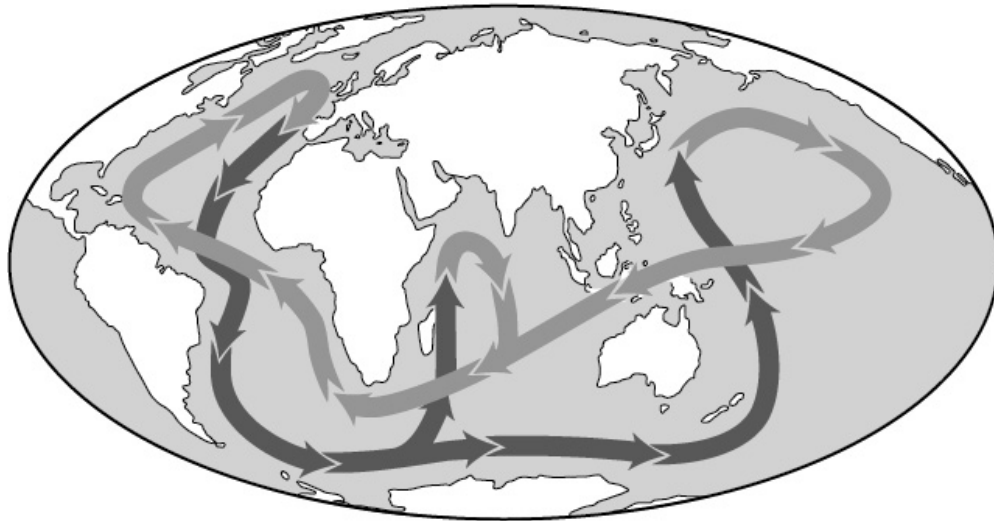

Key	
➔	warmer water
➔	colder water

Temperature is not solely responsible for the density of salt water. The amount of salt in the water affects its density too. The level of salt in ocean water is called salinity.

Activities and Considerations

Activity 1

This activity involves students making a “density rainbow.”

Materials:

- 6 beakers
- Several different kinds of food coloring (a different color for each lab group)
- Sugar
- Straws (clear and colorless)

Directions:

1. Divide students into lab groups.
2. Put equal amounts of water into 6 beakers (one for each group).
3. Using a different color for each group's beaker, add 2 drops of food coloring to each beaker. No beaker can be colorless.
4. Do not add sugar to beaker 1. Add 2 tablespoons of sugar to beaker 2. Add 4 tablespoons of sugar to beaker 3. Add 6 tablespoons of sugar to beaker 4. Add 8 tablespoons of sugar to beaker 5. Add 10 tablespoons of sugar to beaker 6.
5. Have students stir the water in the beakers until all sugar is dissolved.
6. Take the straw, and holding it near one end, wrap four fingers around the straw and place your thumb over the straw's top opening.
7. Lift your thumb off the opening and then dunk the lower end of the straw about 1 inch into beaker 1. Cap the straw firmly with your thumb, lift it out of the water, and dip it quickly into beaker 2. This time, go a little deeper than you did into the first beaker. With the straw in the liquid, lift your thumb but quickly replace it.
8. Continue this process until you have dipped the straw into all 6 beakers and taken some liquid out of each one.

Ask students to make observations about the activity and discuss their observations. They should have observed that the different colors of water were separated in the straw like a rainbow. Have the students describe the densities of each layer (color).

Sample discussion questions include the following:

- Why didn't the different colors of water mix together in the straw?
- Which layer of water is the densest?
- Which layer of water is the least dense?
- How does the formation of the colors (layers) relate to the ocean or atmosphere?

Activity 2

This activity involves students making a density column.

Materials:

- A large graduated cylinder
- Equal amounts of the following liquids:
 - Honey
 - Corn Syrup

- Dish Soap
- Water
- Vegetable oil
- Rubbing alcohol
- Lamp oil

Directions:

1. Use food coloring to color every other liquid.
2. Slowly pour the liquids, one at a time in the order given above, into the center of the cylinder.
3. Allow each layer to settle before adding the next. Do not allow any liquid to touch the walls of the cylinder. Pour slowly and evenly.
4. Have students use the table below to match the substance with its density and explain their reasoning.

Density Data Table

Material	Density (grams per milliliter)
	0.79
	0.81
	0.92
	1.00
	1.33
	1.37
	1.42

Activity 3

This activity involves students determining the density of a variety of objects.

Materials:

- A graduated cylinder
- A balance
- A variety of objects that will fit into the graduated cylinder

Directions:

Have students determine the mass, displacement (volume), and density of a variety of objects.

Considerations

Common misconceptions include the following ideas:

- The smaller an object is, the less density it has.
- Density is the thickness of something.
- Oil weighs less than water. That is why oil floats on water.
- Wood and plastic objects float. Metal objects sink.

Resources

- [The Movement of Air](#)—instructional resource from aric
- [The Great Ocean Conveyor Belt](#)—basic overview of the oceanic conveyor belt system from enviroliteracy.org
- [Seven Layer Density Column](#)—video and instructions for the density column in

How does energy from the Sun affect patterns of atmospheric and oceanic circulation?

How does the circulation of air near the poles differ from the circulation of air near the equator?

How are radiation, convection, and conduction involved in the distribution of heat in Earth's atmosphere?

How can convection currents be demonstrated using a model?

How can a model be used to illustrate the distribution of water temperature in the oceans?

How does salinity affect ocean circulation?

What is the great ocean conveyor belt?

How can a model be used to explain how Earth's rotation affects air and water circulation (the Coriolis Effect)?

Background

The Sun provides the energy for air circulation in the atmosphere and water circulation in the oceans. Because a greater amount of direct sunlight impacts the areas at and near the equator throughout the year, the air in these regions is heated. The air near the equator is less dense and rises. Polar regions receive less solar energy and the air in these regions is colder. This means the air in the polar regions is denser and sinks in the atmosphere. The circulation patterns of the atmosphere are due to heating by the Sun and the rotation of Earth on its axis. These actions result in three main convection currents in each hemisphere.

Surface Wind Bands

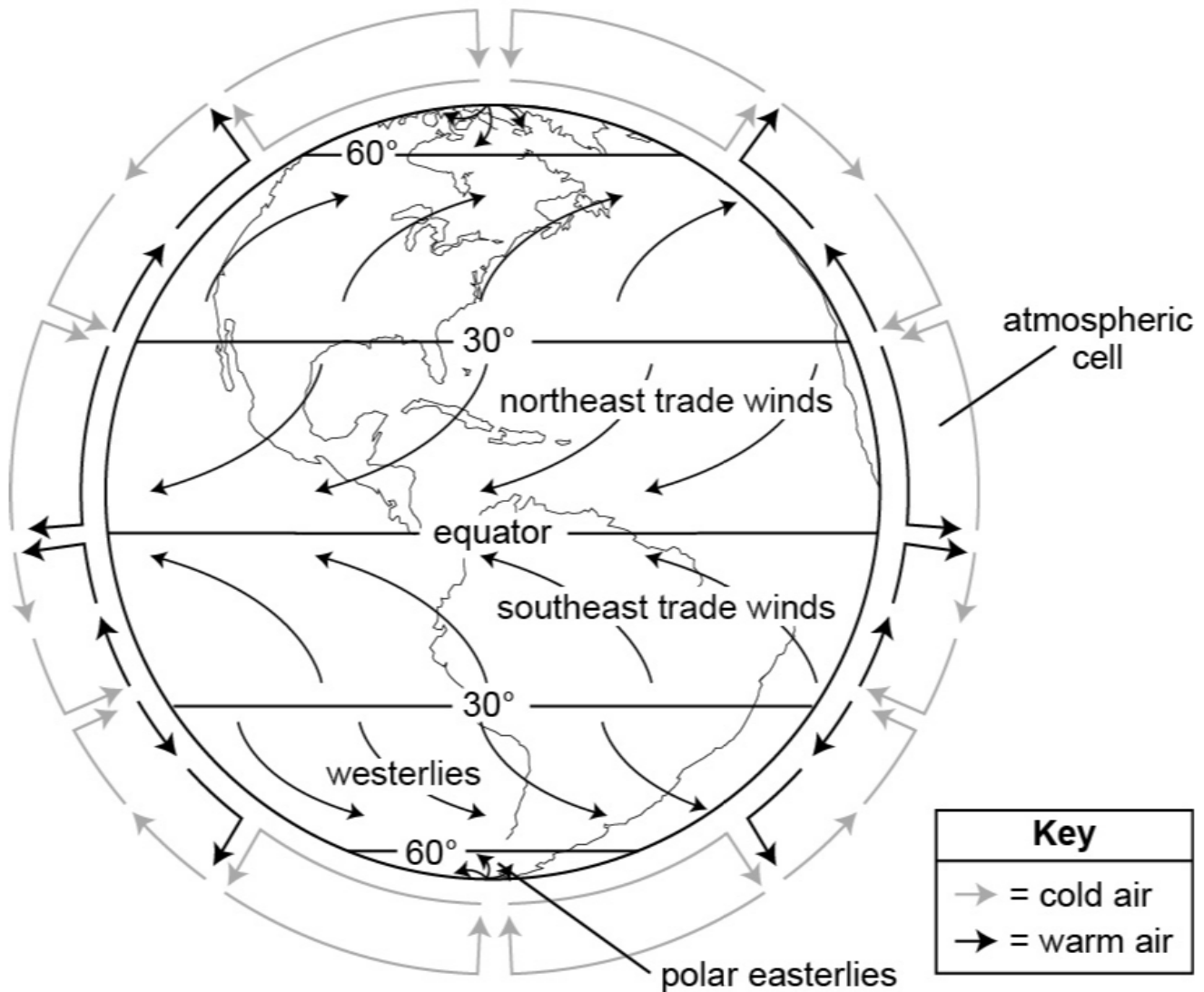

Ocean circulation is also affected by the Sun’s heat and Earth’s rotation, resulting in the conveyor belt circulation pattern shown in the previous section.

Along with water temperature, the amount of salt in ocean water determines its density. More salt can dissolve in warm surface waters than in cold, deep waters. Salinity is the amount of salt dissolved in water, and it is measured in parts per thousand. Typical seawater has a salinity of 35 parts per thousand (ppt) or 3.5%. The average density of seawater at the ocean’s surface is 1.025 grams per milliliter. The model below represents the relationship between salinity and ocean depth. The halocline is the vertical zone in the ocean in which salinity changes rapidly with depth. This zone is located below the well-mixed, uniformly saline surface water layer.

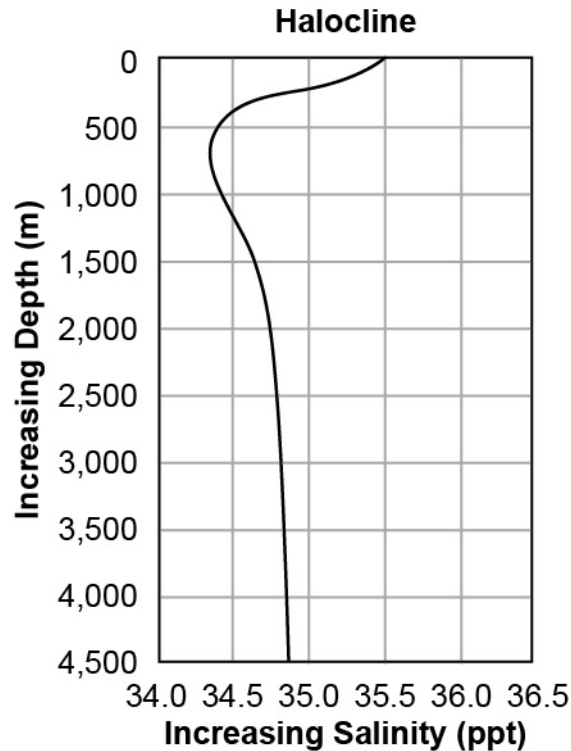

Although convection currents are responsible for the cycling of dense and less dense materials, other methods of energy distribution are also involved in this circulation. Radiation is responsible for the transfer of the Sun's energy through space, and conduction occurs whenever an air or water particle contacts another air or water particle.

Global winds drag on the ocean surface, causing the water to move and build up in the direction that the wind is blowing. Just as the Coriolis effect deflects winds to the right in the northern hemisphere and to the left in the southern hemisphere, it also deflects major surface ocean currents to the right in the northern hemisphere (in a clockwise spiral) and to the left in the southern hemisphere (in a counterclockwise spiral). These spirals form currents called gyres and are found north and south of the equator. There are no gyres at the equator because this area does not experience the Coriolis Effect.

Activity and Considerations

Activity

The process of convection can easily be demonstrated to a class. Students can also build this demonstration themselves with basic materials.

Materials:

- A large clear container or aquarium
- Room-temperature water
- Hot water
- Ice cubes with blue food coloring added
- Water with red food coloring added
- 4 coffee mugs
- Plastic pipette or a turkey baster

Directions:

1. Fill one of the coffee mugs with hot water.
2. Place the container on top of the coffee mugs. Each coffee mug should be under one corner of the container. Make sure the container is stable before proceeding.
3. Fill the container about halfway full with room-temperature water.
4. Place one blue ice cube on the surface away from the side above the mug with hot water.
5. Fill the pipette or turkey baster with the red water.
6. Gently lower the pipette into the water directly above the coffee mug of hot water and slowly release the red water at the bottom of the container.
7. Have students make observations for 2–3 minutes.

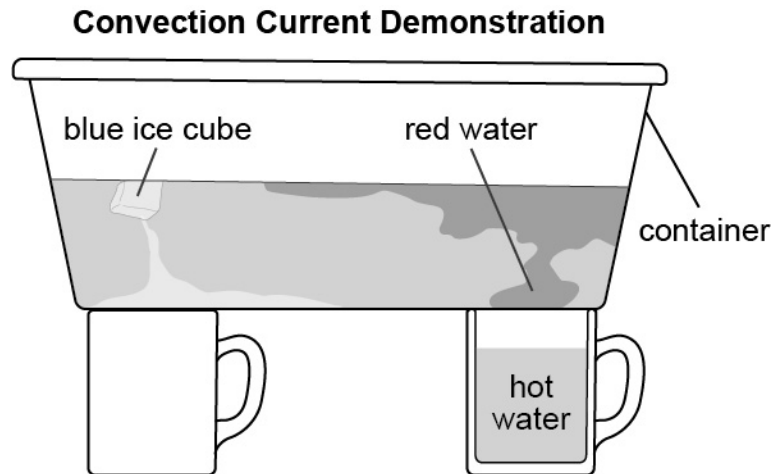

Students should observe that the blue water starts to melt and sink downward to the bottom of the bowl and that the red water warms up and rises to the top of the bowl. Discuss these observations as a class, highlighting the process of convection currents and the different densities of the two colors of water. Relate these phenomena to the processes occurring in Earth's oceans and the resulting conveyor belt, as previously mentioned.

Considerations

Common misconceptions include the following ideas:

- The Gulf Stream is a river in the ocean.
- Ocean currents in the northern hemisphere and the southern hemisphere run in the same direction.
- Oceans have the same salinity everywhere.
- Table salt + water = seawater.

Resources

- [The Coriolis Effect](#)—instructional resource from nationalgeographic.org
- [110 Misconceptions about Oceans](#)—instructional resource about common misconceptions about Earth's oceans

Grade 6

Earth's Systems

6.ESS.14 Analyze and interpret data (e.g., tables, graphs, maps of global and regional temperatures; atmospheric levels of gases such as carbon dioxide and methane; rates of human activities) to describe how various human activities (e.g., use of fossil fuels, creation of urban heat islands, agricultural practices) and natural processes (e.g., solar radiation, greenhouse effect, volcanic activity) may cause changes in local and global temperatures over time.

Connections to *A Framework for K–12 Science Education: Practices, Crosscutting Concepts, and Core Ideas:***Focus for Scientific and Engineering Practice(s):**

- Analyzing and Interpreting Data

Focus for Crosscutting Concept(s):

- Stability and Change
- Patterns
- Cause and Effect

Focus for Disciplinary Core Idea(s):

- Global Climate Change

Key Academic Terms:

global climate change, carbon dioxide, oxygen, water, energy, methane, methane sources, ozone, greenhouse effect

Safety Considerations

Please refer to the [Alabama State Department of Education Lab Safety Guidelines](#).

What is the composition of Earth’s atmosphere?

What gases affect the temperature of Earth’s atmosphere and the surface of Earth?

What is ozone, and how does it affect the global climate?

How do natural processes affect regional and global climates?

Background

Earth’s atmosphere has evolved over time. When it first formed, the atmosphere consisted of steam, carbon dioxide, and ammonia. The density of the ancient atmosphere was also 100 times as dense as today’s atmosphere. Currently, the atmosphere is 78% nitrogen (N₂), 21% oxygen (O₂), and 1% argon (Ar). It also contains trace amounts of carbon dioxide (CO₂), neon (Ne), helium (He), methane (CH₄), and ozone (O₃). In addition, the lower atmosphere of Earth contains water vapor (H₂O). The atmosphere directly over the equator has more water vapor than does the atmosphere over the poles. Water vapor influences the atmosphere’s ability to transmit sunlight and trap infrared light, which leads to possible long-term changes in climate. The graph below models the composition of Earth’s atmosphere up to an elevation of 1,000 km.

The gases of our atmosphere are concentrated near Earth’s surface, and these gases rapidly thin with increasing distance from the surface. At about 100 miles above Earth’s surface, the atmosphere blends with space. The model below is complex but represents a great deal of important information about Earth’s atmosphere. The model includes the following information:

- Atmospheric layers
- Altitude (in kilometers above Earth’s surface)
- Temperature (in °C)
- Location of ozone

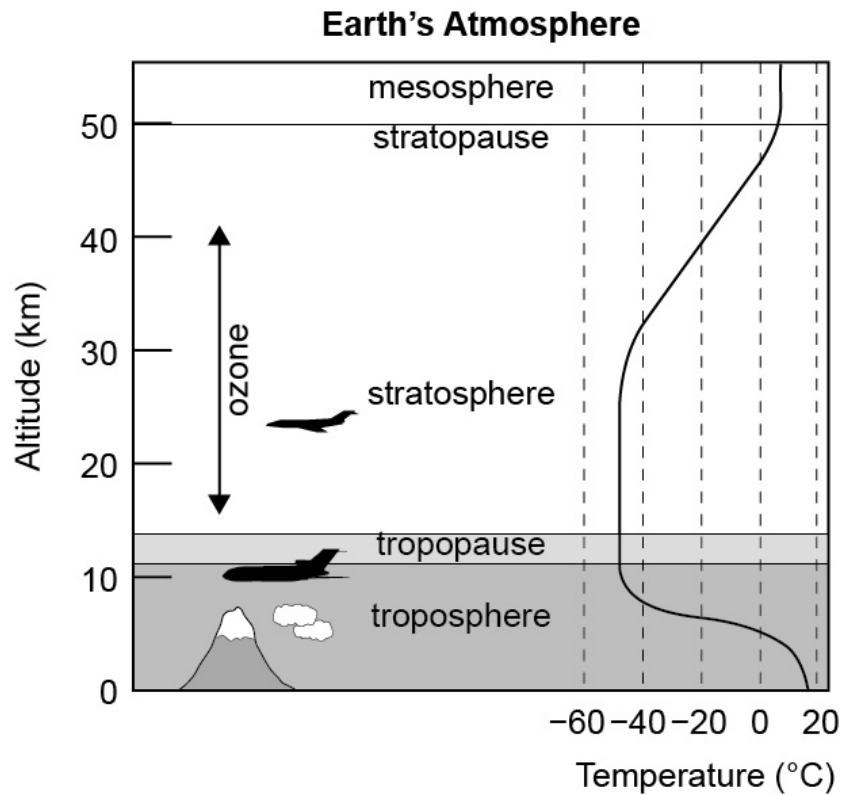

Activities

Activity 1

There are many short, informative videos about Earth's atmosphere that are accessible on the internet. Such a video can be a great way to introduce or review concepts. One example is provided below in the "Resources" section.

Activity 2

This activity is designed to help students understand and explain the processes that can destroy ozone in Earth's atmosphere.

Necessary materials and directions for this activity are provided in a link in the "Resources" section below.

Resources

- [The Greenhouse Effect](#)—video demonstrating Earth's greenhouse effect and global climate change
- [Activity 2 Materials and Directions](#)—teachengineering.org

What is the greenhouse effect?

What human activities are associated with increasing average global temperatures?

How do human activities affect regional and global climates?

How can data be used to show atmospheric changes related to increased global temperatures?

Background

Earth benefits from a process known as the greenhouse effect. This process results in the trapping of heat from the Sun, which is what makes Earth habitable. Several gases, such as water vapor (H_2O), carbon dioxide (CO_2), methane (CH_4), nitrous oxide (NO), and ozone (O_3), play a role in this process. These gases, however, must maintain a relatively small range of concentration above Earth; otherwise, the result could be too little or too much heat held within the atmosphere. People often refer to the greenhouse effect as a negative aspect of Earth's atmosphere, but without it, the entire surface of the planet would resemble the polar regions. However, the increasing concentration of some gases, primarily carbon dioxide and methane, in the atmosphere is responsible for an increase in average global temperatures. Many scientists suggest that much of the concentration of these gases in our changing atmosphere is due to the burning of fossil fuels for energy.

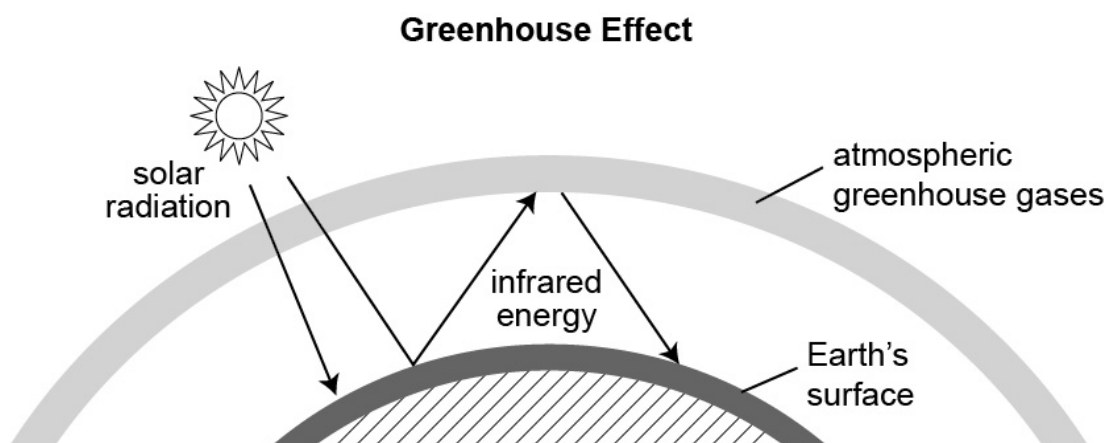

Earth's current atmosphere contains an increasing amount of greenhouse gas molecules. This results in more of the infrared energy emitted by Earth's surface being absorbed by the atmosphere. Since some of the extra energy from the warmer atmosphere radiates back down to the surface of the planet, Earth's surface temperature increases.

Global warming is the unusually rapid increase in Earth’s average surface temperature. Scientists have tracked this phenomenon and have attributed it to the increase of greenhouse gases in our atmosphere. These gases began to increase shortly after the industrial revolution of the late 1800s. Records show that average global surface temperatures increased 0.6 to 0.9°C (1.1 to 1.6° F) between 1906 and 2005. In fact, the *rate* of temperature increase has nearly doubled in the last 50 years. Many scientists point to the burning of fossil fuels and the destruction of carbon-absorbing forests as leading causes for the increase in greenhouse gases in the atmosphere. Additional human-driven changes in land cover, such as urbanization and shifts in vegetation, also affect climate by altering the reflectivity of Earth’s surface.

Heat islands are developed areas that are hotter than nearby rural areas. Data indicates that the annual mean air temperature of a city with 1 million people can be 1–3°C (1.8–5.4°F) warmer than its surroundings. The expansion of green space (lawns and parks), canopy cover (tall trees), and urban farms (neighborhood gardens), along with the increased use of green roofs and walls (covered with growing plants), highly reflective pavements, and storm water storage, are just some of the strategies currently being used to offset heat islands. The image below quantifies the temperature differences observed in an area with these different land use types as related to the heat island effect.

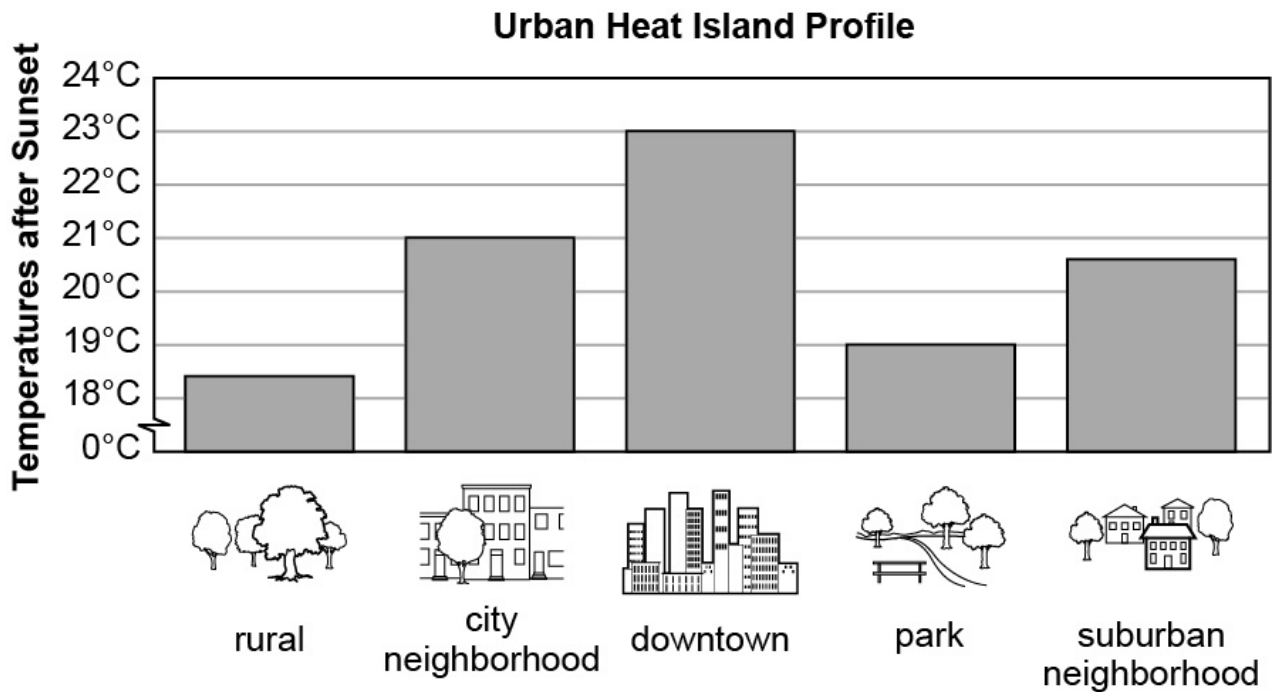

Activities and Considerations

Activity 1

This activity is designed to allow students to model the greenhouse effect.

Materials:

- 2 thermometers
- 1 sealable plastic bag
- 2 empty soda cans
- 100 mL of water

Directions:

1. Divide students into lab groups and give each group a set of materials.
2. Have students place 50 ml of water into each can and then place a thermometer into the water in each can.
3. After 2 minutes, students should record the temperature of the water in each can.
4. Students should then seal 1 can and 1 thermometer in a sealable plastic bag.
5. Now, students should place both cans in a sunny location for 30 minutes.
6. After 30 minutes, students should record the different temperatures of the water in each of the two cans.
7. Finally, students should complete the following data chart and answer the questions below.

Data Table

Can	Initial Temperature of Water in Can	Final Temperature of Water in Can	Change in Water Temperature
In bag			
Not in bag			

Students should answer the following questions related to the activity:

1. Was there a difference in final temperature between the can with the bag around it and the can with no bag? If so, what do you think caused the difference?
2. What do you think would happen to the final temperature of the bagged can if you used a thicker bag, or two bags, around the can?
3. What is the relationship between the cans in this demonstration and the greenhouse effect?
4. Why is the greenhouse effect necessary for life on Earth?
5. How might the greenhouse effect become a problem if the concentration of greenhouse gases in Earth's atmosphere continues to increase?

Activity 2

There are countless models of gas concentrations in the atmosphere available on the internet. Use some of these models in class to help students practice reading data, making conclusions, and predicting the specific effects of gas concentrations on life on Earth. Two example models are shown below. Additional graphs are included in the “Resources” section below.

NOTE: Specific dates in Earth's geologic history may be a sensitive topic for some students and families. Two variations of the same graph are shown below; the first graph does not include specific dates.

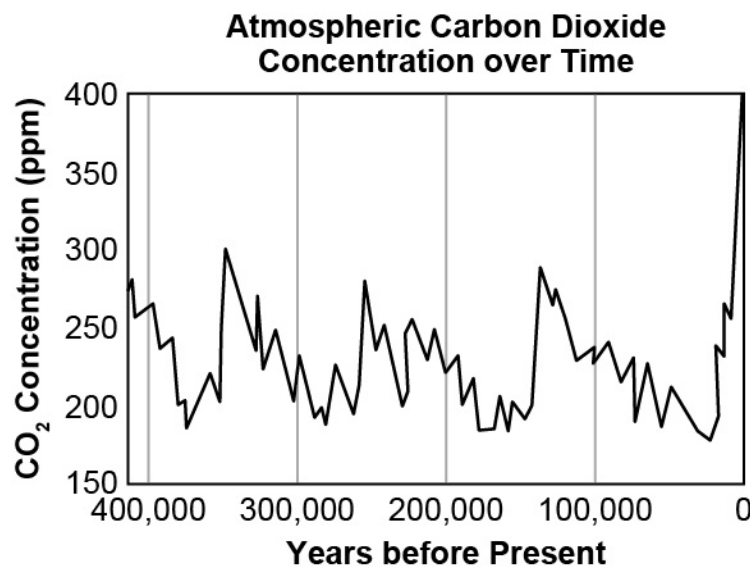
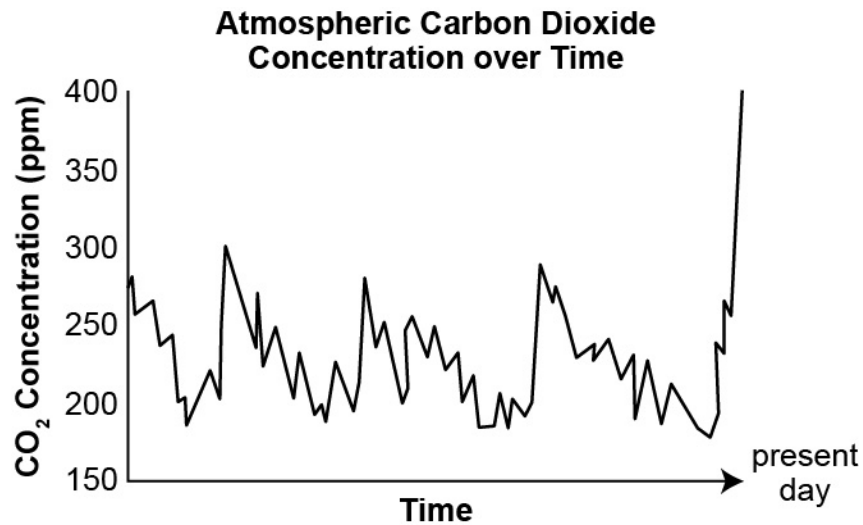

Considerations

Common misconceptions include the following ideas:

- The Sun's energy reflects or bounces off the surface of Earth.
- Climate change is just part of the natural cycle.
- CO₂ makes up only a small part of the atmosphere, so it cannot have a significant heating effect on Earth.
- Human activities alone are what cause the greenhouse effect.

- Global warming is caused by the hole in the ozone layer, which was created by chemicals like hairspray.

Resources

- [The Greenhouse Effect](#)—video demonstrating Earth’s greenhouse effect and global climate change
- [What is the Greenhouse Effect?](#)—basic overview of the greenhouse effect from NASA (climatekids.nasa.gov)
- [Global Warming](#)—basic overview of global climate change from NASA
- [Human Activities that can Influence Climate Change](#)—chart with human activities and their effects on climate change from Stanford University
- [Heat Island Effect](#)—basic overview of heat islands from epa.gov
- [Atmospheric Gas Level Models](#)—instructional resource from NOAA (climate.gov)

Grade 6

Earth's Systems

6.ESS.15 Analyze evidence (e.g., databases on human populations, rates of consumption of food and other natural resources) to explain how changes in human population, per capita consumption of natural resources, and other human activities (e.g., land use, resource development, water and air pollution, urbanization) affect Earth's systems.

Connections to *A Framework for K–12 Science Education: Practices, Crosscutting Concepts, and Core Ideas*:**Focus for Scientific and Engineering Practice(s):**

- Analyzing and Interpreting Data
- Constructing Explanations

Focus for Crosscutting Concept(s):

- Cause and Effect
- Patterns

Focus for Disciplinary Core Idea(s):

- Human Impacts on Earth Systems

Key Academic Terms:

per capita, consumption, urbanization, pollution, engineered solution, geosphere, biosphere, hydrosphere

Safety Considerations

Please refer to the [Alabama State Department of Education Lab Safety Guidelines](#).

What Earth systems are affected by human activities?

How can data explain how human populations are changing and which factors affect human populations?

How can data be used as evidence to show a relationship between land use, resource access, development, and human populations?

What is meant by “per capita consumption of a resource”?

What actions can reduce the effects of human consumption of natural resources?

What is urbanization?

What is the relationship between changes in human population and changes in water and air pollution?

How might engineered solutions alter the effects of human activities on Earth’s systems?

Background

All of Earth’s systems are affected by humans and their activities. Humans change the gases in the atmosphere by burning natural resources found within the geosphere. Excess chemicals added to the geosphere find their way into the hydrosphere and affect the dissolved gases and nutrients needed by the biosphere.

Scientists monitor these changes by collecting data over long periods of time. By analyzing changes in stable systems, humans can hypothesize about and investigate how they alter their natural surroundings. Human consumption of goods alters the way we use land and resources. Technology has helped to make resource access easier and more cost-effective. Industry uses technology to develop new concepts and new technology so that future generations can have a more convenient lifestyle.

Enhancements to human lifestyles have been followed by population increases in many areas. In turn, these population increases place new demands on the resources needed for human survival and comfort. This cycle goes on and on.

To avoid depleting the resources we depend upon, humans need to become wiser and minimize resource consumption for the benefit of future generations. Humans need to make long-term plans and commitments now to avoid problems associated with resource shortages tomorrow.

Scientists, city planners, and technology innovators are able to develop long-term plans for resource consumption by analyzing current data and making immediate changes to established systems. Scientists can calculate the per capita rate of consumption (average rate of consumption by a person) through the analysis of the total known consumption of a total population for a specific region.

One of the greatest challenges in our future involves accommodating a growing population of humans. The presence of more people tends to encourage urbanization, which is the development of densely populated areas. This process damages natural environments, expands heat islands, affects atmospheric and hydrologic quality, and changes global conditions. Urbanization can increase air and water pollution and deplete natural resources like groundwater. As human population increases, more people are contributing to the global demand for resources.

Data have been collected and models have been created to demonstrate tremendous demands that humans place on the natural world, which have negatively affected the environment. The graphs below represent some of these data.

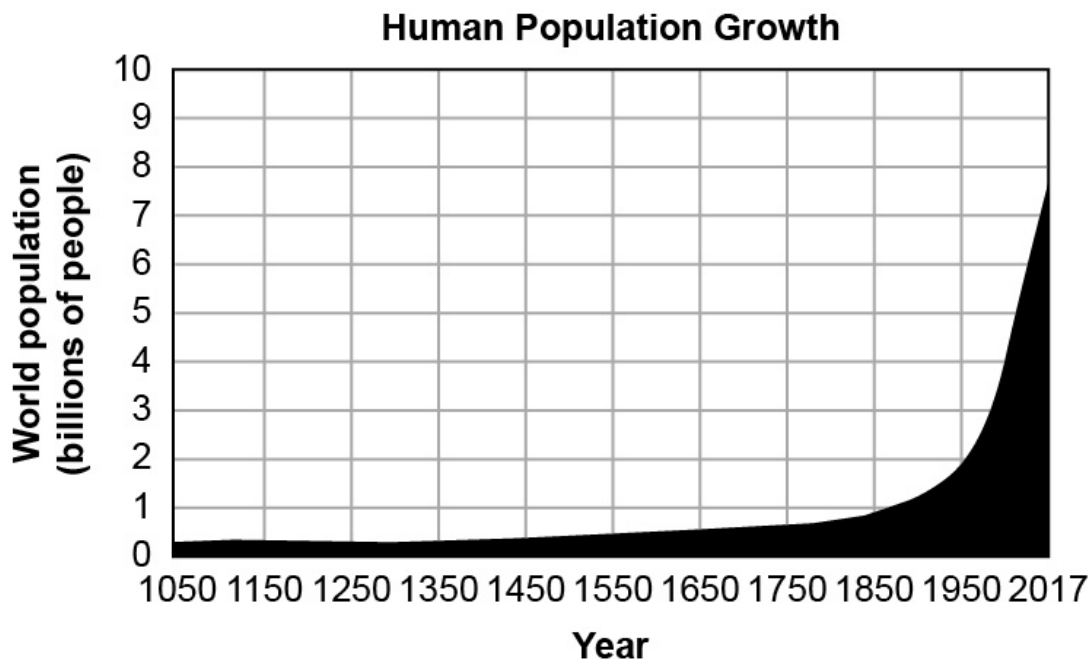

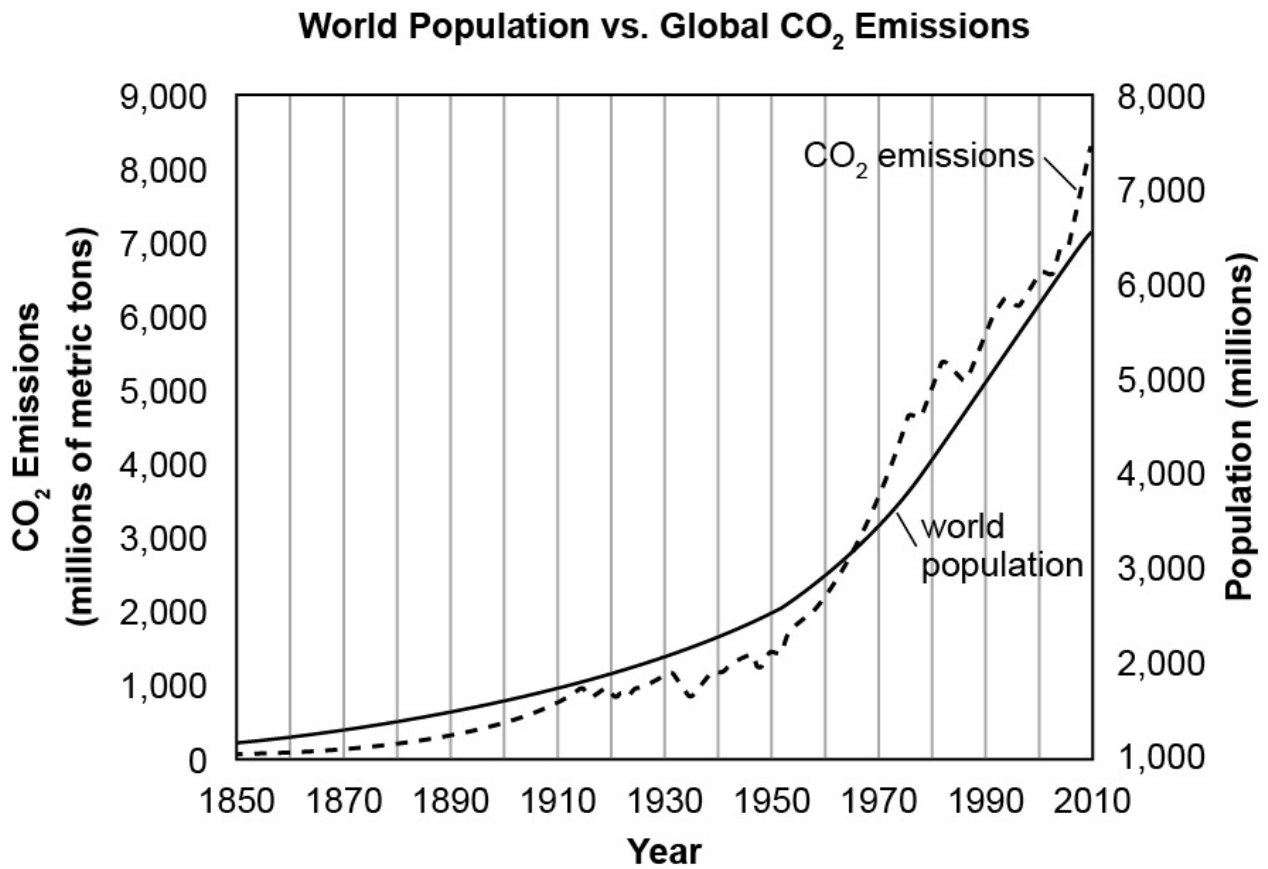
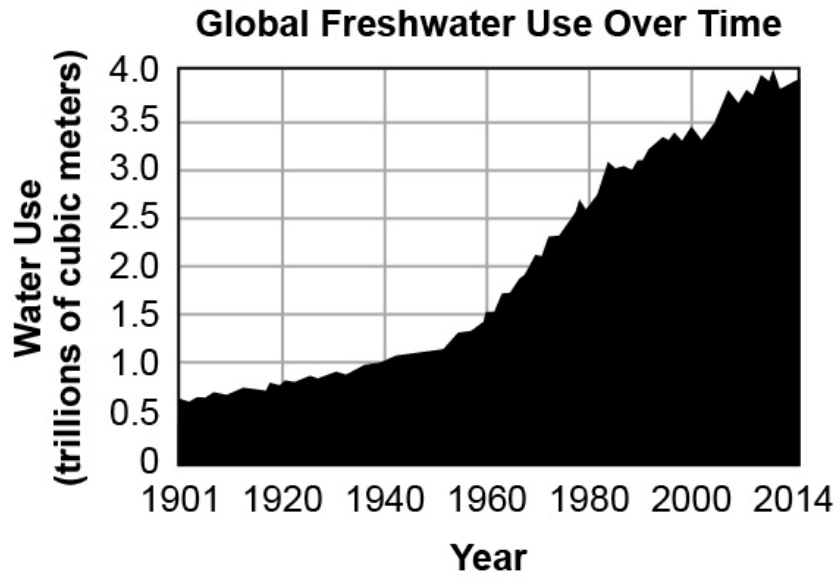

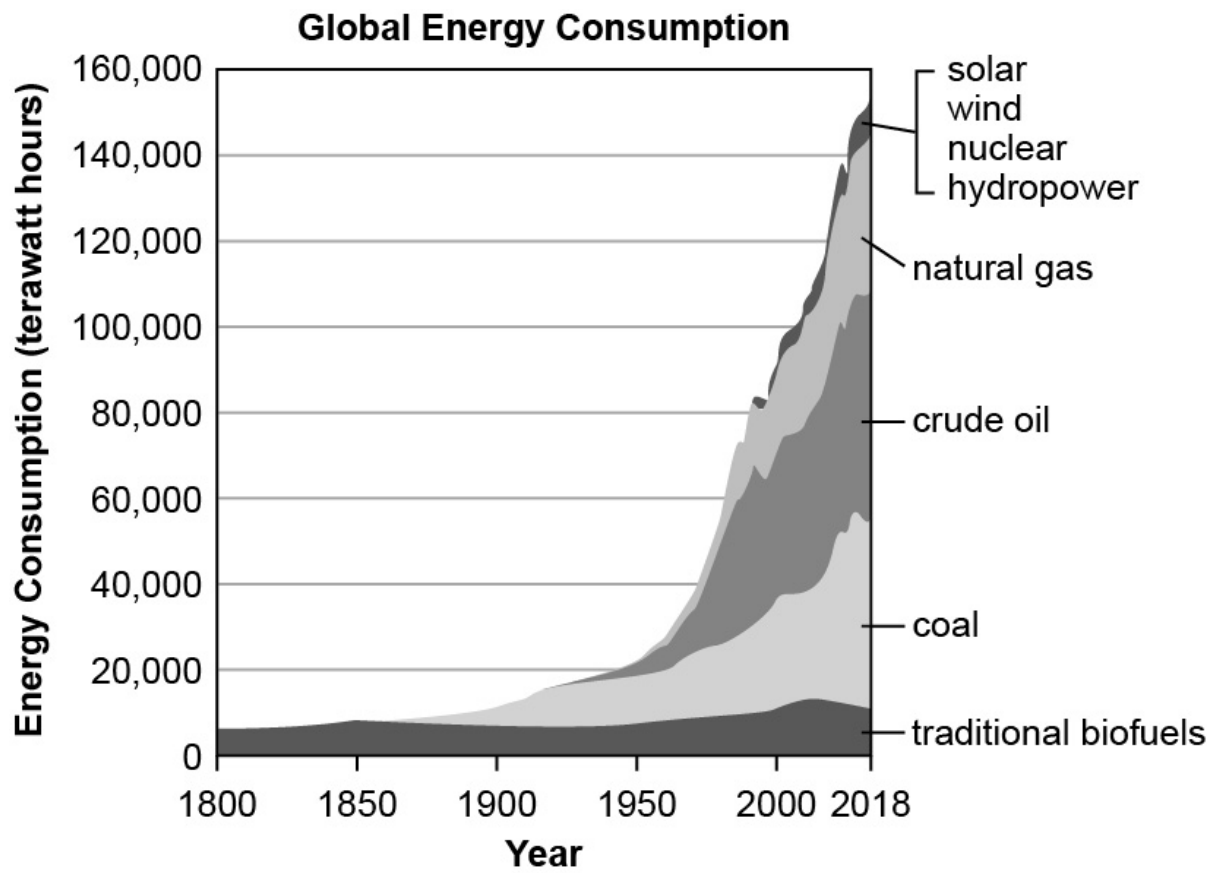

Activities and Considerations

Activity 1

There are numerous videos online that illustrate the impact humans have on the global environment. If computer access is available, assign videos to small groups of students and have them present key information from the videos to the class. This activity reinforces the availability of data on the web, and students can also practice filtering data based on the reliability of data sources. PBS has some short, kid-friendly videos about human impacts on the environment; a link is provided in the “Resources” section below.

Activity 2

This activity explores the ecological footprint that humans have on the environment. An ecological footprint is defined as the impact a person or community has on the environment. This footprint is expressed as the amount of land required to sustain a person or community’s use of natural resources to continue living the way they are. Necessary materials and directions for this activity are provided in a link in the “Resources” section below.

Considerations

Common misconceptions include the following ideas:

- Resource availability is all about physical supply.
- Population growth will inevitably cause the world to run out of resources.
- Resource availability is all about recycling.
- Environmental sustainability requires that we lower our standard of living.

Resources

- [Activity 2 Materials and Directions](#)— The following link requires users to create an account before accessing the material; there are no fees associated with this account. (footprintcalculator.org)
- [Activity 2 Accompanying Worksheet](#)— Students should complete the accompanying worksheet, which makes resource utilization more personal. (online PDF)
- [Human Impacts on the Environment](#)—PBS video from Activity 2
- [The Global Population Situation: An Overview](#)—facts and data about the effects of the growing human population on the environment
- [Water Use and Stress](#)—facts and data about the use of freshwater from ourworldindata.org
- [Top 10 Myths about Sustainability](#)—list of common misconceptions about sustainability

Grade 6

Earth's Systems

6.ESS.16 Implement scientific principles to design processes for monitoring and minimizing human impact on the environment (e.g., water usage, including withdrawal of water from streams and aquifers or construction of dams and levees; land usage, including urban development, agriculture, or removal of wetlands; pollution of air, water, and land).

Connections to *A Framework for K–12 Science Education: Practices, Crosscutting Concepts, and Core Ideas*:**Focus for Scientific and Engineering Practice(s):**

- Constructing Explanations and Designing Solutions

Focus for Crosscutting Concept(s):

- Cause and Effect
- Influence of Science, Engineering, and Technology on Society and the Natural World

Focus for Disciplinary Core Idea(s):

- Human Impacts on Earth Systems

Key Academic Terms:

human impact, consumption, pollution, urbanization, natural resource, wetland, aquifers, depletion

Safety Considerations

Please refer to the [Alabama State Department of Education Lab Safety Guidelines](#).

How do dams affect the natural environment?

How are groundwater sources depleted, and what are the impacts of this depletion?

How can humans reduce water consumption and their overall effects on water supplies?

Background

Humans affect their environment, and the environment affects humans. To maintain the sustainability of life on the planet, humans are realizing that they need to minimize their alteration of Earth and its systems, while still enhancing their own existence. Egyptians built the first dam thousands of years ago. They captured the motion of river water to move grinding stones and prevent flooding. Today, humans use dams to produce electricity from the power of moving water. However, a dam can negatively affect surrounding environments by flooding areas above the dam, sacrificing local natural habitats. Dams also displace humans and their homes due to flooding. To decrease the impact on wildlife, people have built fish passages in some dams that enable migrating fish to make their way back to the upstream areas where spawning occurs. Nevertheless, dams change the natural environment.

Humans are dependent on groundwater supplies. Groundwater supplies drinking water for 51% of the total U.S. population and 99% of the nation's rural population. Industries such as mining, oil and gas drilling, and agriculture all contribute to the contamination and draining of these groundwater supplies.

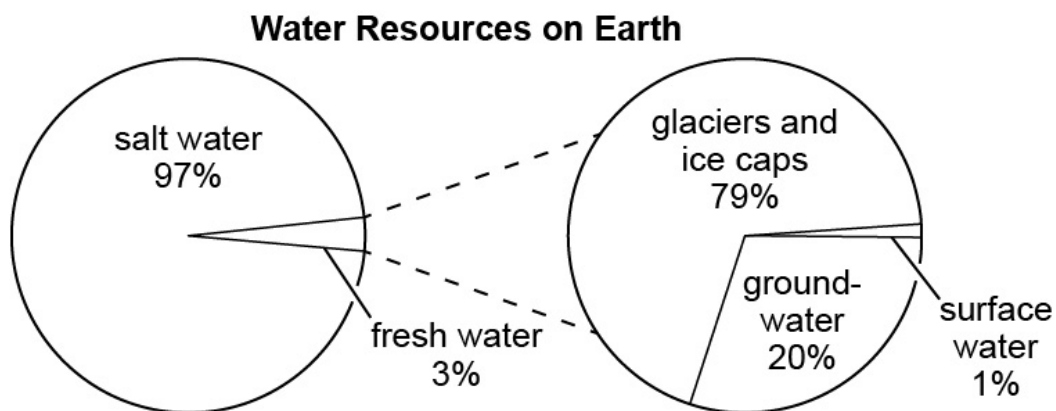

The impact of industry on groundwater supplies reduces current and future generations' access to adequate fresh water. Many areas of the United States have been limiting the amount of water used in landscaping and in display fountains in an effort to save our groundwater.

sources. Some cities even encourage citizens to collect rainwater and use it to maintain ground cover on their property. In many schools, children are encouraged to make individual contributions, such as turning off water while brushing their teeth or taking shorter showers. These efforts show students that they, too, can reduce their water usage.

Freshwater Use in the United States in 2015 (millions of gallons per day)

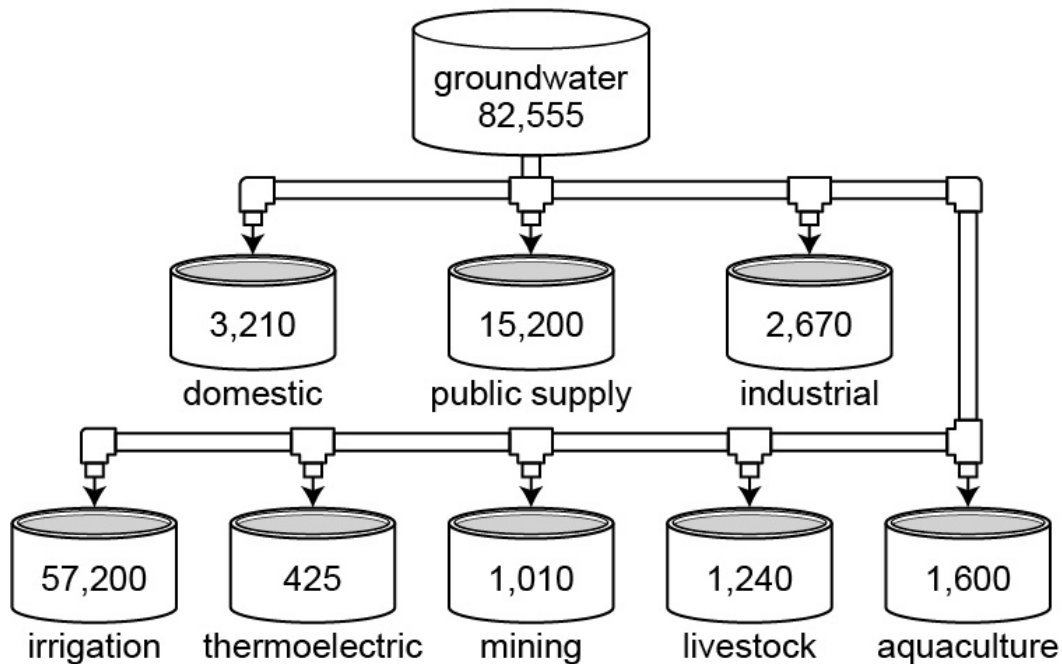

Activities

Activity 1

This activity is designed to help students learn about how much water they are using for specific purposes. The result provides each student with a “water footprint,” which is an estimate of the amount of water a person uses. Students may be unaware of the tremendous amounts of water that many daily activities require.

A footprint calculator activity and a resource about methods to save water are provided in a link in the “Resources” section below.

Activity 2

This is a computer-based activity from High-Adventure Science. It is best to work through all seven sections of the activity so that students can see the interaction of surface water and groundwater in the first steps of the activity.

Necessary materials and directions for this activity are provided in a link in the “Resources” section below.

NOTE: The link to this site may need to be copied and pasted into a search bar or search field to work properly.

Resources

- [Activity 1 Footprint Calculator](#)—watercalculator.org
- [Activity 1 Methods to Save Water](#)— watercalculator.org
- [Activity 2 Materials and Directions](#)—High-Adventure Science
- [Groundwater Use in the United States](#)—overview of water uses in the United States from usgs.gov
- [Negative Impacts of Hydroelectric Dams](#)—overview of some of the negative effects of building hydroelectric dams from brightengineering.com
- [What is Groundwater?](#)—overview of what groundwater is and the human dependency of groundwater

What purpose do wetland areas serve?

What is the relationship between wetlands and the quality of fresh water?

What is land pollution, and how can it be minimized?

How does urbanization affect the quality of human life?

How can humans reduce their land usage?

What technological advances have enabled farmers to increase harvests?

How can air quality be monitored?

How can air quality be improved by factories and electricity production facilities?

How can human consumption of natural resources be monitored?

Background

Urban sprawl has had a negative effect on the natural wetlands of our planet. These wetland areas establish the basis of many food webs that interconnect with food webs far from the actual wetland area. Wetlands filter groundwater reserves and help to purify our atmosphere. The damaging or clearing of wetlands starts a destructive cycle that causes harm to humans and the environment.

Humans also cause land pollution. Land pollution is the destruction of Earth's land surfaces that occurs either directly or indirectly as a consequence of human activities. Humans often misuse Earth's resources and thereby increase the pollution of Earth's surface. Landfills are one clear example of how human activity and misuse of resources pollute land. In a landfill, human waste materials lie for many years and leak their contents, forming toxic pools of waste. Reclaiming that polluted land requires severe remediation and years of treatment. Humans develop new materials to use for specific innovations and products, but people often fail to plan for how they will deal with the waste produced by these new materials. Recycling has helped to reduce land pollution, but it alone cannot solve this problem.

As populations increase, cities expand. Large cities place huge demands on the natural resources in those areas. The presence of these cities affects the natural environments and the use of local resources. Additionally, the streets and buildings of large cities affect everything

from air temperatures to air quality to the migration patterns of birds and butterflies. Large cities provide their residents with access to entertainment and enrichment, but they also cause air pollution, noise pollution, water pollution, and land pollution. The data below represent global land use related to food production.

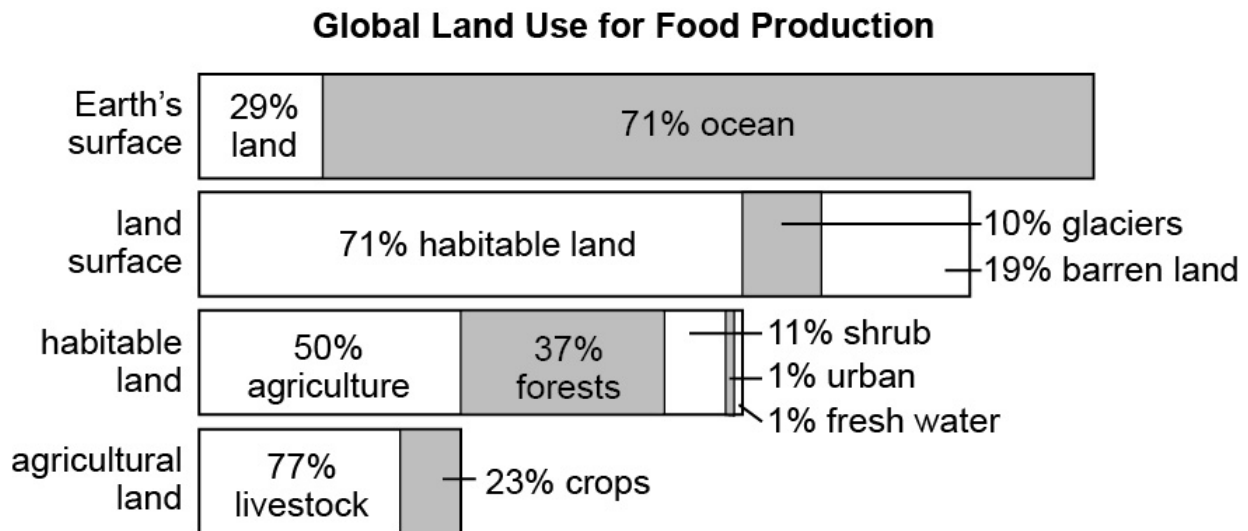

Land abuse by humans results in a severe reduction of land resources. Protecting our natural resources requires that people find and use processes that sustain the quality of the land, rather than harming it.

To deal with the impacts that agriculture has on the resources of the land, agriculture has turned to technology. In the last 10 years, agriculture technology has undergone tremendous development. Major innovations have focused on areas such as indoor vertical farming, livestock technology, modern greenhouse practices, precision agriculture, automation and robotics, and artificial intelligence. In particular, genetically modified livestock and crop plants have led to increased harvests of organisms with high nutritional value. These organisms have helped feed a soaring human population using fewer natural resources.

Water and air are the basic resources that all organisms share. In recent years, discussions of global warming have brought a great deal of attention to what humans put into Earth's atmosphere. Each nation has its limits and regulations, but there is no global consensus about what kinds of pollution need to be monitored and controlled. In the United States, the Environmental Protection Agency (EPA) is responsible for the monitoring and enforcement of air quality standards. Currently, this federal agency monitors the presence of seven primary air pollutants:

1. Carbon monoxide
2. Lead
3. Nitrogen dioxide

4. Ozone
5. Particulate matter (large)
6. Particulate matter (small)
7. Sulfur dioxide

Current data indicate that nationally, the concentrations of air pollutants have dropped significantly since 1990. Air quality concentrations can vary year to year and are affected not only by emissions but also by natural events, such as dust storms, wildfires, and variations in weather. Tracing pollution has its challenges because some pollutants are released directly into the atmosphere (emissions), while other pollutants are formed in the air from chemical reactions.

Air pollution sources include the following:

- stationary fuel combustion sources (e.g., electric utilities and industrial boilers)
- industrial and other processes (e.g., metal smelters, petroleum refineries, cement kilns, and dry cleaners)
- highway vehicles (e.g., cars and trucks)
- non-road mobile sources (e.g., recreational and construction equipment, marine vessels, aircraft, locomotives)

Current data indicate that the human consumption of Earth's natural resources has tripled in the last 40 years. It is easy to see that if that trend continues, within a few generations Earth will cease to provide the resources humans need to survive. Luckily, many experts and leaders are aware of these data and are working to reduce the extraction of resources from our planet. Alternative energy sources are trending toward those forms of energy that do not pollute our water or atmosphere and can incorporate recycled materials. Countries are beginning to think globally rather than just nationally. Currently, the richest countries consume, on average, 10 times as much of the available resources as the poorest countries and twice as much as the world average. That means a few countries are producing most of the pollution by which all humans are affected. Currently, each nation sets its own limits about consumption of natural resources. Treaties between nations concerning pollution do exist, but to truly have a global effect, many more nations must work together to reduce resource consumption.

Activity and Considerations

Activity

This activity allows students to identify pollution levels in an area and the source point for the pollution.

Materials:

- 2 cups sand
- 2 cups sand
- 2 cups sand + 8 tablespoons powdered lemonade mix
- 2 cups sand + 6 tablespoons powdered lemonade mix
- 2 cups sand + 4 tablespoons powdered lemonade mix
- 2 cups sand + 2 tablespoons powdered lemonade mix
- Map (shown below)

Map of Spill Area

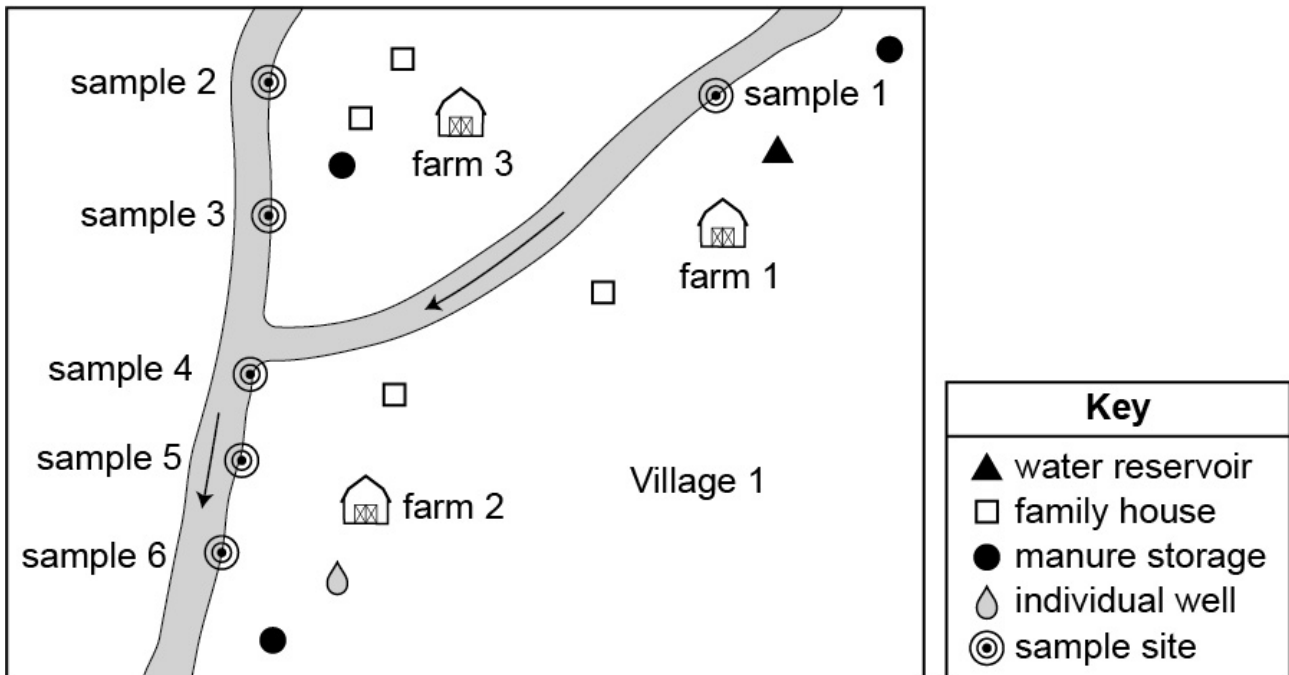

Follow these steps for the activity:

1. Place each sample into a zipper-seal plastic bag.
2. Divide students into lab groups of 2 or 3.
3. Supply each group with the following materials:
 - a. 6 plastic cups (have students label them 1–6)
 - b. 1 plastic spoon
 - c. access to water
 - d. 6 strips pH paper (can be litmus or pH paper)
4. Have students read the purpose of the investigation.
5. Explain and demonstrate the use of pH paper for determining acidity.
6. Students should add the same amount of water to each cup (10–20 ml).
7. Students should add the same amount of soil to the corresponding cup and mix thoroughly.

NOTE: Rinse the spoon after mixing each cup.

8. Students should determine the pH (acid/base) of each sample.
9. Students should determine the location of the spill on the map.
10. Students should answer the activity questions below:
 - a. Where is the spill location on the map?
 - b. What evidence supports your conclusion about the spill location?
 - c. Can groundwater in the map area be affected by this spill? Why or why not?

Considerations

Common misconceptions include the following ideas:

- Solid particles are more harmful than gases.
- Using diesel as fuel is better for the environment than using gasoline as fuel.
- Burning wood does not harm the environment.
- There is nothing I can do about pollution.
- Air pollution is present only if people can see it.
- Air quality is always better indoors than outdoors.

Resources

- [Facts and Tips about Land Pollution](#)—overview of land pollution from eschooltoday.com
- [Land Use Data](#)—breakdown of how land is used globally from ourworldindata.org
- [Air Pollution Monitoring](#)—instructional resource from epa.gov
- [Air Quality Trends Data](#)—resource showing trends in concentrations of common air pollutants from epa.gov
- [Human Consumption of Earth’s Natural Resources](#)—article on the growing consumption of natural resources by humans from ecowatch.com
- [Groundwater Pollution Sources](#)—overview of sources of common groundwater pollution

*This page is
intentionally left
blank.*

Copyright © 2020 by the Alabama State Department of Education. The materials contained in this publication may be duplicated by Alabama educators for local classroom use. This permission does not extend to the duplication of materials for commercial use.

Alabama Educator Instructional Supports: ACAP Summative Survey

Please take a few minutes to answer 10 survey questions by April 30, 2021. You may complete the survey electronically here: <https://www.surveymonkey.com/r/WXZWXCT>. If you prefer to mail in your survey, you may print this page and mail it in an envelope using the address on the next page. You may also print this double-sided with the following page, fold it into thirds, seal it with tape, and mail it. The survey takes approximately five minutes to complete.

1. Which content area(s) did you use? (Check all that apply.)

- English Language Arts Mathematics Science

2. Which grade(s) did you use? (Check all that apply.)

- 2 3 4 5 6 7 8

3. In which state district (such as Leeds City or Winston County) do you work? _____

4. What is your current position/job title?

- Classroom teacher
- Curriculum coach/specialist (school or district)
- Teacher assistant/classroom aide/paraprofessional
- Administrator
- Other (please specify): _____

5. For how many standards did you use the material in the Instructional Supports when planning your instruction?

- All Most Some None

6. How helpful were the Instructional Supports in providing a deeper understanding of the standards?

- Very helpful Helpful Somewhat helpful Not helpful

7. How helpful were these documents to you when planning instruction?

- Very helpful Helpful Somewhat helpful Not helpful

8. How many times did you consult the Instructional Supports documents while planning instruction?

- Daily A few times A few times A few times during One or Zero times
a week a month the school year two times

9. How likely are you to recommend the use of the Instructional Supports to other teachers in your district or school?

- Very likely Somewhat likely Somewhat unlikely Very unlikely

10. Is there any additional information about the Instructional Supports that you would like to share or any additional resources that you would like to see included?

Thank you for taking the time to fill out the survey.

(fold here)

Place stamp
here. Postal
service will not
accept without
a stamp.

Data Recognition Corporation
Attn: Alabama Instructional Supports Feedback
2800 Northwest Boulevard
Plymouth, MN 55441

(fold here)