



SUMMATIVE

Grade 6 Mathematics

Alabama Educator Instructional Supports

Alabama Course of Study Standards

Introduction

The *Alabama Instructional Supports: Mathematics* is a companion to the 2016 *Revised Alabama Course of Study: Mathematics* for Grades K–12. Instructional supports are foundational tools that educators may use to help students become independent learners as they build toward mastery of the *Alabama Course of Study* content standards. **Instructional supports are designed to help educators engage their students in exploring, explaining, and expanding their understanding of the content standards.**

The content standards contained within the course of study may be accessed on the Alabama State Department of Education (ALSDE) website at www.alsde.edu. When examining these instructional supports, educators are reminded that content standards indicate minimum content—what all students should know and be able to do by the end of each grade level or course. Local school systems may have additional instructional or achievement expectations and may provide instructional guidelines that address content sequence, review, and remediation.

The instructional supports are organized by standard. Each standard’s instructional support includes a statement of the content standard, guiding questions with connections to mathematical practices, key academic terms, and additional resources.

Content Standards

The content standards are the statements from the 2016 *Revised Alabama Course of Study: Mathematics* that define what all students should know and be able to do at the conclusion of a given grade level or course. Content standards contain minimum required content and complete the phrase “Students will ____.”

Guiding Questions with Connections to Mathematical Practices

Guiding questions are designed to create a framework for the given standards and to engage students in exploring, explaining, and expanding their understanding of the content standards provided in the 2016 *Revised Alabama Course of Study: Mathematics*. Therefore, each guiding question is written to help educators convey important concepts within the standard. By utilizing guiding questions, educators are engaging students in investigating, analyzing, and demonstrating knowledge of the underlying concepts reflected in the standard. An emphasis is placed on the integration of the eight Standards for Mathematical Practice.

The Standards for Mathematical Practice describe the varieties of expertise that mathematics educators at all levels should seek to develop in their students. They are based on the National Council of Teachers of Mathematics process standards and the strands of mathematical proficiency specified in the National Research Council’s report *Adding It Up: Helping Children Learn Mathematics*.

The Standards for Mathematical Practice are the same for all grade levels and are listed below.

1. Make sense of problems and persevere in solving them.
2. Reason abstractly and quantitatively.
3. Construct viable arguments and critique the reasoning of others.
4. Model with mathematics.
5. Use appropriate tools strategically.
6. Attend to precision.
7. Look for and make use of structure.
8. Look for and express regularity in repeated reasoning.

Each guiding question includes a representative set of sample activities and examples that can be used in the classroom. The set of activities and examples is not intended to include all the activities and examples that would be relevant to the standard.

Key Academic Terms

These academic terms are derived from the standards and are to be incorporated into instruction by the educator and used by the students.

Additional Resources

Additional resources are included that are aligned to the standard and may provide additional instructional support to help students build toward mastery of the designated standard. Please note that while every effort has been made to ensure all hyperlinks are working at the time of publication, web-based resources are impermanent and may be deleted, moved, or archived by the information owners at any time and without notice. Registration is not required to access the materials aligned to the specified standard. Some resources offer access to additional materials by asking educators to complete a registration. While the resources are publicly available, some websites may be blocked due to Internet restrictions put in place by a facility. Each facility's technology coordinator can assist educators in accessing any blocked content. Sites that use Adobe Flash may be difficult to access after December 31, 2020, unless users download additional programs that allow them to open SWF files outside their browsers.

Your Feedback

ALSDE and DRC value your feedback. The last two pages of this document contain a survey about your experience using the Alabama Educator Instructional Supports. Once you have had a chance to use and become familiar with these Instructional Supports, please take the time to fill out the survey. The Instructional Supports, as well as your responses to the survey, will be discussed during an educator review meeting in summer 2021.

Printing This Document

It is possible to use this entire document without printing it. However, if you would like to print this document, you do not have to print every page. First, identify the page ranges of the standards or domains that you would like to print. Then, in the print pop-up command screen, indicate which pages you would like to be printed.

Ratios and Proportional Relationships

Understand ratio concepts and use ratio reasoning to solve problems.

1 Understand the concept of a ratio, and use ratio language to describe a ratio relationship between two quantities.

Examples: “The ratio of wings to beaks in the bird house at the zoo was 2:1 because for every 2 wings there was 1 beak.” “For every vote candidate A received, candidate C received nearly three votes.”

Guiding Questions with Connections to Mathematical Practices:**What is a ratio?**

M.P.6. Attend to precision. Describe a ratio as a quantitative comparison between two or more sets. Ratios can represent part-to-part and part-to-whole relationships. A ratio can be interpreted as a composed unit relating a whole to a part-to-part relationship that is repeatable. For example, 2 parts red paint and 3 parts blue paint can be combined to create a composed unit of a particular shade of purple paint. For all quantities of paint in this particular shade of purple, the ratio of red paint to blue paint will be some multiple of the ratio 2 to 3. Composed units can also be partitioned into parts that maintain the original ratio. For example, a pitcher of juice is made by combining 3 parts concentrate with 5 parts water. A glass of the juice would have reduced quantities of concentrate and water in the same ratio as the entire pitcher of juice. Additionally, a ratio can be a composed unit representing a part-to-whole relationship. For example, a fruit salad is made of 6 total cups of fruit, 1 cup of which is strawberries. The ratio of cups of strawberries to cups of total fruit salad will be some multiple of the ratio 1 to 6.

- Ask students to find real-world comparisons between two or more sets and represent the part-to-part or part-to-whole relationships. It may be appropriate to have students describe at least one example of a part-to-part relationship and at least one example of a part-to whole relationship.

- Ask students to discuss how ratios are repeatable and why that is important. For example, use a juice concentration as a demonstration. If a juice recipe requires 8 cups water and 2 cups powder mix, how can the recipe be increased or decreased as needed and still have the same concentration? If the recipe is repeated three times, 8 cups of water are combined with 2 cups of powder mix three times. In total, 24 cups of water are combined with 6 cups of powder mix. This illustrates why the ratio 8:2 is the same as the ratio 24:6. Similarly, if 4 cups of water are combined with 1 cup of powder mix twice, then in total, 8 cups of water are combined with 2 cups of powder mix. This illustrates why the ratio 8:2 is also the same as the ratio 4:1.

When is it appropriate to describe a situation using ratios and ratio language?

M.P.3. Construct viable arguments and critique the reasoning of others. Create examples and non-examples of ratio situations using ratio language. For example, use “for every” to describe the ratio 4:5 as “for every 4 dollars, you can buy 5 oranges” or a ratio of 4 dollars to 5 oranges. Additionally, the phrase “for every 2 yellow beads, there are 3 blue beads” is an example of a part-to-part ratio relationship of 2:3. However, the situation “Maria is twice as old as her brother Marco. Marco is 5 years old. How old will Maria be in 2 years?” cannot be described with a ratio, as Maria will not always be twice as old as Marco.

- Ask students to practice using ratio language and notation. Provide two whole numbers, in context, to the students. Then, ask students to record part-to-part ratios of the example using ratio language. For example, give students the information that 3 tablespoons of sugar are used to make 2 dozen pancakes.

For every 3 tablespoons of sugar in a pancake recipe, the recipe makes 2 dozen pancakes. Different ways to write the ratio include: 3:2, $\frac{3}{2}$, and 3 to 2, because for every 3 tablespoons of sugar there are 2 dozen pancakes.

- Help students to find examples of ratios in real-world situations. Ask students to describe their examples using ratio language and explain why using ratios is appropriate for each example. Students should also practice writing the ratio using ratio language for the real-world comparison. In the example shown, a student journal entry references the comparison of the cost of potatoes at a particular grocery store.

A real-world example of a comparison that can be represented with a ratio is buying potatoes at the grocery store. The cost of 5 pounds of potatoes is \$6.00. This comparison can be appropriately described with a ratio because the relationship is repeatable or decomposable. For example, at the same grocery store, 10 pounds of potatoes would cost \$12.00, and buying 5 pounds of potatoes twice would also cost \$12.00. Furthermore, 2.5 pounds of potatoes cost \$3.00. Different ways to write the ratio include: 5:6, $\frac{5}{6}$, 5 to 6, and for every 5 pounds of potatoes the cost is \$6.00.

- Ask students to discuss non-examples of real-world ratios. Students defend their non-examples with arguments to explain why their examples are not appropriate situations for using ratios. For example, students are provided with a situation, such as “Anita has three books and her sister, Diana, has two books. Anita and Diana each get two more books.” Make an argument as to why it is not appropriate to describe the situation using ratios. A sample student response is shown.

It is not appropriate to describe this situation using ratios because the initial comparison of their books is 3:2. After they get more books, the comparison is 5:4. If the situation were to be represented with a single ratio, the ratio should be repeatable. Repeating the initial ratio of 3:2 would result in a ratio of 6:4, not 5:4.

M.P.4. Model with mathematics. Recognize and create a variety of models that illustrate ratio relationships. For example, a picture of 4 green cubes and 3 red cubes in a bag has a part-to-part ratio of 4 to 3. The same bag of cubes would have part-to-whole ratios of 4 green cubes to 7 total cubes or 3 red cubes to 7 total cubes. Additionally, part-to-part and part-to-whole ratio relationships can be demonstrated with geometric models and bar models.

- Ask students to use a geometric model to identify different ratios that can be created from the model. First create a geometric model of a fraction. Then, identify and describe the ratio relationships that can be formed from the geometric model. For example, the geometric model shown is divided into equal parts, with some parts shaded. Therefore, comparisons of the shaded parts, non-shaded parts, and total parts are possible.

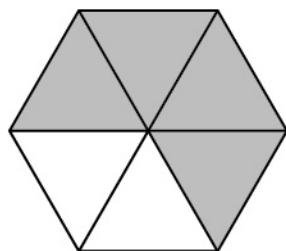

Non-shaded parts to shaded parts...	2:4
Shaded parts to non-shaded parts...	4:2
Shaded parts to total parts.....	4:6
Non-shaded parts to total parts.....	2:6

- Ask students to demonstrate comparisons with a bar model. First represent a simple situation with a bar model. Then, show how the ratio repeats with a continuation of the bar model. For example, the bar model shows 7 tiles used for a bathroom wall, including 2 gray tiles and 5 white tiles. Using the same ratio of gray tiles to white tiles, a contractor uses 28 total tiles to cover a wall. The bar model shows how the contractor determines the total number of gray tiles and white tiles that are needed.

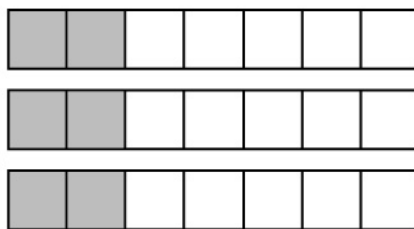
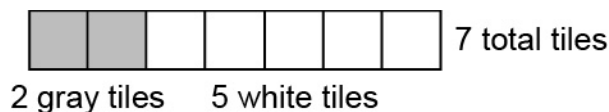

Key Academic Terms:

ratio, quantity, relationship, part-to-part, part-to-whole, composed unit

Additional Resources:

- Lesson: [Introducing ratios!](#)
- Tutorial: [Write a ratio from a word problem](#)

Ratios and Proportional Relationships

Understand ratio concepts and use ratio reasoning to solve problems.

2 Understand the concept of a unit rate $\frac{a}{b}$ associated with a ratio $a:b$ with $b \neq 0$, and use rate language in the context of a ratio relationship.

Examples: “This recipe has a ratio of 3 cups of flour to 4 cups of sugar, so there is $\frac{3}{4}$ cup of flour for each cup of sugar.” “We paid \$75 for 15 hamburgers, which is a rate of \$5 per hamburger.” (Expectations for unit rates in this grade are limited to noncomplex fractions.)

Guiding Questions with Connections to Mathematical Practices:

What is a unit rate?

M.P.6. Attend to precision. Describe a unit rate as a ratio expressed in the form $a:b$ or $\frac{a}{b}$ where the value of b is 1. For example, the speed of a car is 55 miles per hour, or $\frac{55 \text{ miles}}{1 \text{ hour}}$. Additionally, traveling 110 miles in 2 hours is a rate that is equivalent to 55 miles per hour because repeating a trip 55 miles in 1 hour two times gives the same result. However, $\frac{110 \text{ miles}}{2 \text{ hours}}$ is not a unit rate because the value of b in that expression is not 1.

- Help students to recognize unit rates from everyday real-world contexts. In the following examples, students are given the first measure and must determine the missing measure, b , in the comparison. Students should justify the second measure, and there can be multiple correct answers. Emphasize that what makes a unit rate is not the missing measure itself, but the fact that the comparison implies that there is 1 of that measure.

- Miles per _____

hour: This is a unit rate because it describes the speed of driving as a distance traveled in 1 hour. A vehicle that drives 30 miles per hour would cover a distance of 30 miles every 1 hour.

- Dollars per _____

pound: This is a unit rate because the ratio comparison is expressed as per pound, which also means for every 1 pound. Buying food that costs \$2 per pound means that each time you bought 1 pound of that food, it would cost you \$2.

- Cups per _____

quart: This is a unit rate because it compares the size of a cup to the size of 1 quart. Because there are 4 cups per quart, every time you measure out 1 quart of something, it would be equivalent to measuring out 4 cups.

- Ask students to write measure comparisons in the correct form for unit rates given in a variety of different ways. In the examples shown, the given situation is provided to students, and each response is represented in fraction form.
 - Cynthia makes \$10.00 an hour at her job. The unit rate is $\frac{10 \text{ dollars}}{1 \text{ hour}}$.
 - A landscaper uses 1 gallon of gas to mow 8 lawns. The unit rate is $\frac{8 \text{ lawns}}{1 \text{ gallon}}$.
 - Herman sleeps an average of 7 hours per night. The unit rate is $\frac{7 \text{ hours}}{1 \text{ night}}$.

M.P.4. Model with mathematics. Recognize and create a variety of models that illustrate ratio and unit rate relationships. For example, given the situation “A restaurant charges \$8.00 for 4 chicken strips. How much does the restaurant charge for one chicken strip?” draw a visual representation to show the cost for one chicken strip. Additionally, a table can be used to model unit rates.

- Ask students to draw a picture to represent a given situation and use the model to determine the unit rate of the situation. For example, the model shown represents the work to determine the cost of a car tire when a set of four car tires costs \$460.

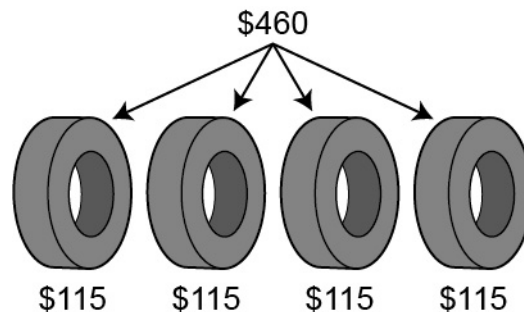

Confirm that the unit rate is \$115 per tire by observing that buying 1 tire for \$115 four times results in the same situation as buying 4 tires for \$460.

- Ask students to create a table to model a unit rate of a given situation. For example, students created the table shown after they were given the following situation: “A scientist records the population of frogs in a nature park. The scientist recorded 120 frogs in 8 acres. What is the average number of frogs per acre in the nature park?”

Area (in acres)	1	2	3	4	5	6	7	8
Average number of frogs	15	30	45	60	75	90	105	120

The table shows that 1 acre with 15 frogs shown eight times results in the same acreage and number of frogs as having 8 acres with 120 frogs in it. Therefore, the unit rate is 15 frogs per acre.

How can unit rate relationships be described?

M.P.6. Attend to precision. Describe the meaning of unit rate and use vocabulary correctly when describing unit rates. For example, a can of soup costs \$1.50 for 12 ounces, so the unit rate, which in this case means the number of dollars for exactly one ounce, is found using the proportion

$\frac{\$1.50}{12 \text{ ounces}} = \frac{\$0.125}{1 \text{ ounce}} = \0.125 per ounce. The rate could also be thought of in terms of the quantity per dollar. The proportion would be $\frac{12 \text{ ounces}}{\$1.50} = \frac{8 \text{ ounces}}{\$1} = 8$ ounces per dollar. Additionally, unit rates can be used to compare two rates that would normally be difficult to compare.

- Ask students to describe a situation and then determine the unit rate, showing the work to do the conversion. For example, if it takes Amira 22 minutes and 30 seconds to run 3 miles, what is Amira’s average running pace in minutes per mile? A student response is shown.

$$\frac{22.5 \text{ minutes}}{3 \text{ miles}} = \frac{7.5 \text{ minutes}}{1 \text{ mile}} = 7 \text{ minutes and } 30 \text{ seconds per mile}$$

- Ask students to perform cost comparisons when purchasing items by determining the unit rates and comparing them. For example, Yogurt A costs \$3.52 for 32 ounces of yogurt and Yogurt B costs \$0.78 for 6 ounces of yogurt. The given rates are difficult to compare because Yogurt A is larger, which might make Yogurt A the better deal, but on the other hand, Yogurt B costs less, which might make Yogurt B the better deal. Ask students to determine the unit rates.

$$\text{Yogurt A: } \frac{\$3.52}{32 \text{ oz.}} = \frac{\$0.11}{1 \text{ oz.}}$$

$$\text{Yogurt B: } \frac{\$0.78}{6 \text{ oz.}} = \frac{\$0.13}{1 \text{ oz.}}$$

Yogurt A is a better deal because it costs less per ounce.

Key Academic Terms:

ratio, rate, unit rate, quantity, relationship, part-to-part, part-to-whole

Additional Resources:

- Tutorial: [Convert to unit rates](#)
- Tutorial: [Rates and unit rates](#)

Ratios and Proportional Relationships

Understand ratio concepts and use ratio reasoning to solve problems.

3 Use ratio and rate reasoning to solve real-world and mathematical problems, e.g., by reasoning about tables of equivalent ratios, tape diagrams, double number line diagrams, or equations.

3a Make tables of equivalent ratios relating quantities with whole-number measurements, find missing values in the tables, and plot the pairs of values on the coordinate plane. Use tables to compare ratios.

Guiding Questions with Connections to Mathematical Practices:

How can patterns in ratio models be used to solve various ratio problems?

M.P.4. Model with mathematics. Identify and use patterns in ratio tables to solve various ratio problems. For example, given the problem “Julio makes green paint by mixing 4 parts blue paint to every 5 parts yellow paint. How many parts yellow paint should Julio use if he wants the same color of green paint and uses 8 parts blue paint?” solve by making a ratio table. Notice the additive pattern of adding 4 when moving down the table from blue to blue and adding 5 when moving down the table from yellow to yellow and the multiplicative pattern of multiplying by 1.25 when comparing blue to yellow. Additionally, ratio tables can be used to identify subtraction or division patterns to solve ratio problems.

- Ask students to create a ratio table to represent and extend a given ratio pattern. For example, given the situation “A construction worker uses 6 spacers for every 2 floor tiles when installing a bathroom floor,” create a table to represent the number of spacers that are needed for certain numbers of tiles that may be used for the flooring.

Number of Spacers	Number of Tiles
6	2
12	4
18	6

- Ask students to identify patterns in a ratio table and justify the patterns found. For example, given the context “A baker makes 6 cups of caramel sauce by mixing 4 parts sugar with 2 parts butter. How many parts sugar should the baker use if he wants the same caramel recipe and uses $\frac{1}{2}$ part butter?” make a table and respond, as shown.

Sugar	4	8	12	16
Butter	2	4	6	8

The answer is 1 part sugar for $\frac{1}{2}$ part butter because the ratio table shows the quantity of sugar is twice the amount of the butter and $\frac{1}{2}$ multiplied by 2 is 1.

How can plotting values from a table onto a coordinate plane help solve ratio problems?

M.P.1. Make sense of problems and persevere in solving them. Connect ratio tables and the patterns within them to their corresponding coordinate pairs on the coordinate plane. For example, notice that the coordinate pairs created by ratio tables always create straight lines through the origin. Additionally, the straight lines created from the ratio ordered pairs help identify ratio pairs that are not integers.

- Ask students to graph a given ratio table on a coordinate plane and make observations about any patterns they identify in the graph. For example, given the part-to-whole ratio table, graph and make observations, as shown.

Part	3	6	9	12
Whole	5	10	15	20

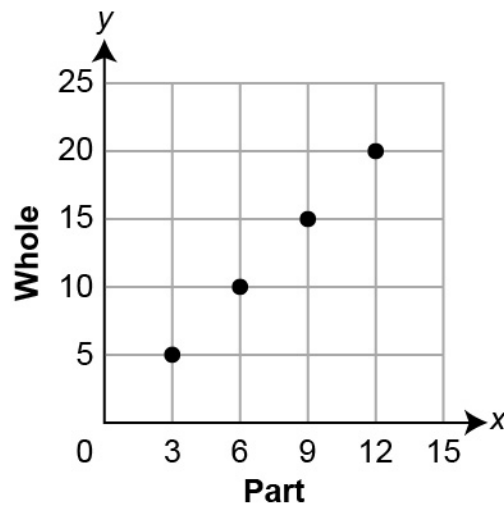

The ordered pairs created from the part-to-whole ratios create a straight line through the origin. For every 5 units of increase on the graph, the next point is 3 units to the right.

- Ask students to solve a ratio problem with a non-integer solution. For example, given the situation “A car can be driven 19 miles for every $\frac{1}{2}$ gallon of gasoline it has. How far can the car be driven on 4.25 gallons of gasoline?” create a ratio table and corresponding graph.

Gallons	0	0.5	1	1.5	2
Miles	0	19	38	57	76

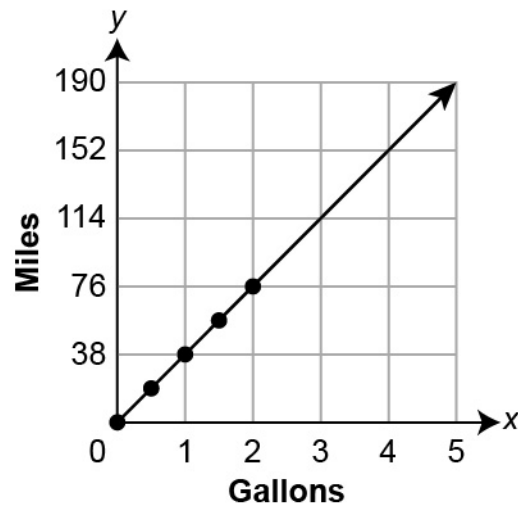

Use the ratio table and graph to estimate the non-integer solution that 161.5 miles can be driven on 4.25 gallons of gasoline.

Key Academic Terms:

ratio, rate, equivalent ratio, table, tape diagram, double number line diagram, equation, coordinate plane

Additional Resources:

- Tutorial: [Find the missing value](#)
- Lesson: [Finding equivalent ratios](#)

Ratios and Proportional Relationships

Understand ratio concepts and use ratio reasoning to solve problems.

3 Use ratio and rate reasoning to solve real-world and mathematical problems, e.g., by reasoning about tables of equivalent ratios, tape diagrams, double number line diagrams, or equations.

3b Solve unit rate problems including those involving unit pricing and constant speed.

Example: If it took 7 hours to mow 4 lawns, then at that rate, how many lawns could be mowed in 35 hours? At what rate were lawns being mowed?

Guiding Question with Connections to Mathematical Practices:

How can unit rates be used to solve problems?

M.P.4. Model with mathematics. Demonstrate how a unit rate can be found using a variety of strategies. For example, to answer the questions “If 3 pounds of grapes cost \$4.20, how much does 1 pound of grapes cost? How much do 5 pounds of grapes cost?” use a double number line to find the unit rate of \$1.40 and use multiplicative thinking to find that 5 pounds of grapes cost \$7.00. Additionally, a unit rate can be found by modeling the situation with a bar model.

- Ask students to determine the unit rate of a given situation by using a double number line. For example, given the situation “Davonna gets a paycheck for 1 week of work. She worked 20 hours that week. The take-home pay of the paycheck was \$300. How much take-home pay does Davonna earn per hour of work?” create a double number line to solve the problem. An example model is shown.

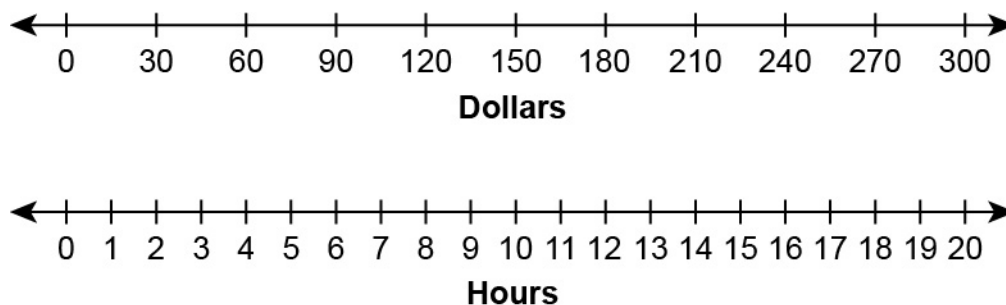

The take-home pay Davonna earns per hour is \$15.

- Ask students to draw a bar model to solve a unit rate problem. For example, the bar model shown represents the situation “It takes Natal 32 minutes to complete 8 math problems. How much time, in minutes, does it take Natal to complete 1 math problem?”



Natal completes 1 math problem in 4 minutes.

Key Academic Terms:

unit rate, unit pricing, constant speed, equivalent ratio table, double number line, equation

Additional Resources:

- Lesson: [Who's faster? Comparing ratios & rates](#)
- Activity: [Friends meeting on bicycles](#)

Ratios and Proportional Relationships

Understand ratio concepts and use ratio reasoning to solve problems.

3 Use ratio and rate reasoning to solve real-world and mathematical problems, e.g., by reasoning about tables of equivalent ratios, tape diagrams, double number line diagrams, or equations.

3c Find a percent of a quantity as a rate per 100 (e.g., 30% of a quantity means $\frac{30}{100}$ times the quantity); solve problems involving finding the whole, given a part and the percent.

Guiding Questions with Connections to Mathematical Practices:

What is a percent and how is percent related to ratios?

M.P.6. Attend to precision. Understand the concept of percent and connect ratios and percent. For example, define a percent as a ratio that is always expressed out of 100, such as $27\% = \frac{27}{100}$.

Additionally, create equivalent fractions to express a ratio out of 100 and determine the percentage.

- Ask students to convert a percent to a ratio. For example, 8% can be represented by the fraction $\frac{8}{100}$, which can also be considered a ratio of 8 to 100. Ask students to find other ratios equivalent to $\frac{8}{100}$, such as $\frac{4}{50}$ and $\frac{2}{25}$.
- Ask students to convert a ratio to a percent. For example, 11 out of 25 students are in band. The fraction $\frac{11}{25}$ can be scaled to $\frac{44}{100}$, determining that 44% of students are in band. Ask students to show each step of the conversion.

How can ratio patterns be used to find common percents?

M.P.2. Reason abstractly and quantitatively. Find patterns and use ratio reasoning to solve percent problems. For example, to find 40% of 60, find 10% of 60, which is 6. Then, multiply 6 by 4 to find 24 (40% is 4 times 10%). Additionally, to find 5% of a number, find 10% of the value and divide it by 2.

- Ask students to find a percentage of a value and explain their reasoning. For example, given the problem “Find 25% of 82,” students may respond as follows:

I know that 50% of 82 is 41. Then, I found half of 41 to get the solution of 20.5.

- Ask students to identify and write general strategies that can be used to solve various percent problems. Some examples are provided.
 - *To find 60% of a value, first find 10%, and then multiply by 6 because $10\% \times 6 = 60\%$.*
 - *To find 25% of a value, first find 50%. Then, find half of the 50% value because $50\% \div 2 = 25\%$.*
 - *To find 75% of a value, first find 50%. Then, find half of the 50% value, which is 25%. Lastly, add the 50% value to the 25% value, because $50\% + 25\% = 75\%$.*
 - *To find 20% of a value, first multiply the value by two. Then, find 10% of the doubled value, because $2 \times 10\% = 20\%$.*

What strategies can be used to find the missing part or whole in a percent problem?

M.P.1. Make sense of problems and persevere in solving them. Use a variety of strategies and models to solve percent problems that involve finding the whole given the percent, finding the part given the whole, and finding the part given the percent. For example, answer the question “What percent of 32 is 8?” by recognizing that 8 is $\frac{1}{4}$ of 32 and that 25 is $\frac{1}{4}$ of 100 to determine that 8 is 25% of 32. Additionally, visual models are a useful strategy to solve percent problems.

- Ask students to explain how to solve a percent problem by writing out the reasoning in words. First, give students a percent problem, such as “What percent of 70 is 7?” Then, ask students to explain a method to solve the problem using prior knowledge. A sample student response is shown.

I know that 70 divided by 7 is 10, so that means 7 is $\frac{1}{10}$ (or equivalently, $\frac{10}{100}$) of 70. Since 7 is $\frac{10}{100}$ of 70, then 7 is 10% of 70.

- Ask students to create a visual model to represent and solve a percent problem. For example, given the problem “What percent of 28 is 7?” create a visual model. An example is shown.

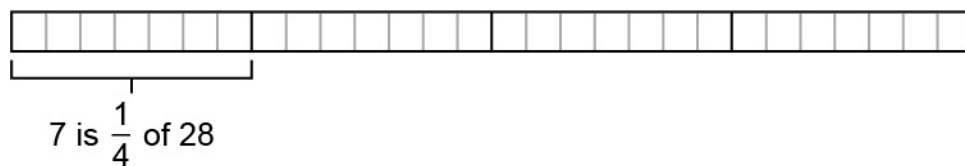

Since 7 is $\frac{1}{4}$ of 28, that means 7 is 25% of 28.

Key Academic Terms:

percentage, per 100, quantity, whole, part

Additional Resources:

- Activity: [Tax, tips, and discounts scavenger hunt](#)
- Lesson: [Ratios and percents](#)
- Lesson: [Basics of percent](#)
- Lesson: [Finding percent of a number with diagrams](#)

Ratios and Proportional Relationships

Understand ratio concepts and use ratio reasoning to solve problems.

3 Use ratio and rate reasoning to solve real-world and mathematical problems, e.g., by reasoning about tables of equivalent ratios, tape diagrams, double number line diagrams, or equations.

3d Use ratio reasoning to convert measurement units; manipulate and transform units appropriately when multiplying or dividing quantities.

Guiding Questions with Connections to Mathematical Practices:

How is ratio reasoning used to convert measurement units within or between customary and metric systems?

M.P.5. Use appropriate tools strategically. Use a variety of strategies to show patterns of conversion between and within measurement systems. For example, using a centimeter/inch ruler simulates a double number line and can be used to find the conversion between inches and centimeters. Additionally, use a bar model to demonstrate the conversion of liquid measurements.

- Ask students to determine the number of centimeters in an inch by modeling with a double number line. For example, given the problem “Rounded to the nearest tenth, there are 2.5 centimeters in 1 inch. How many centimeters are in 6 inches?” create a double number line to model the answer of about 15 centimeters.

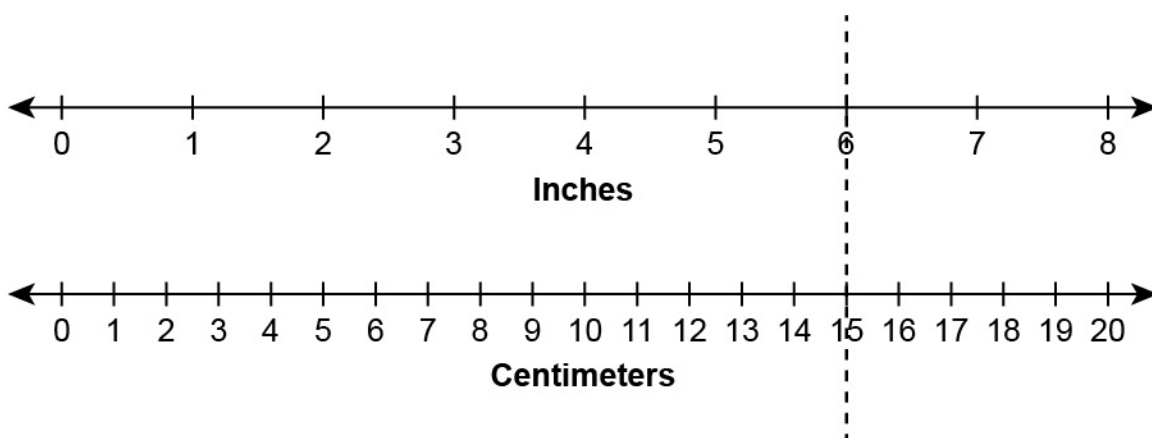

- Ask students to determine the number of cups in a certain number of quarts and use a bar model to show the conversion. For example, given the problem “There are 4 cups in 1 quart. How many cups are in 5 quarts?” create a bar model to represent the conversion and find the answer of 20 cups.

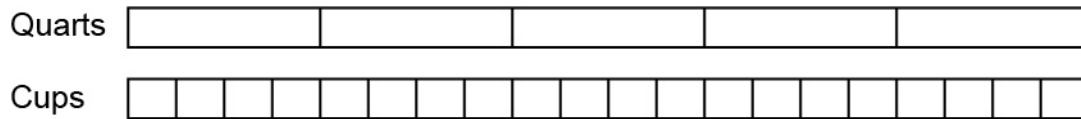

How can the proper unit be determined when solving conversion problems?

M.P.6. Attend to precision. Determine the correct unit when solving conversion problems by using the context. For example, given that 1 quart is approximately 0.95 liter, when finding how many quarts are in 3 liters, correctly identify the ending unit as quarts. Additionally, determine the correct units for each part of the conversion ratio in a problem in order to have a resulting answer with the appropriate unit.

- Ask students to complete one-step conversion problems. For example, “Given 1 ounce is approximately 28.35 grams, how many ounces is 113.4 grams?” can be solved by dividing the number of grams needed by the number of grams in one ounce, as shown.

$$113.4 \text{ grams} \div 28.35 \text{ grams per ounce} = 4 \text{ ounces}$$

There are 4 ounces in 113.4 grams.

- Ask students to show the work of converting a ratio and include unit labels at each step. For example, given that there are about 7.62 centimeters in 3 inches, find approximately how many centimeters are in 2 feet. Sample work is shown.

$$2 \text{ feet} \times \frac{12 \text{ inches}}{1 \text{ foot}} \times \frac{7.62 \text{ centimeters}}{3 \text{ inches}} = \frac{2 \times 12 \times 7.62}{3} \text{ centimeters} = 60.96 \text{ centimeters}$$

The measurements of 2 feet and 60.96 centimeters are equal because the fractions that are being multiplied by 2 feet are both equivalent to 1. (The numerator and denominator are equal for each fraction.) The units used in the answer are centimeters because the conversion ratios eliminate the feet and inches, so there are 60.96 centimeters in 2 feet.

Key Academic Terms:

convert, conversion, measurement, customary system, metric system, ratio, table, unit

Additional Resources:

- Tutorial: [What is dimensional analysis?](#)
- Lesson: [Converting units](#)
- Video: [Real-life math | Zoo keeper, Hoofstock](#)
- Activity: [Scale City | One-dimensional scaling to find unknown heights](#)

The Number System

Apply and extend previous understandings of multiplication and division to divide by fractions.

4 Interpret and compute quotients of fractions, and solve word problems involving division of fractions, e.g., by using visual fraction models and equations to represent the problem.

Examples: Create a story context for $(\frac{2}{3}) \div (\frac{3}{4})$, and use a visual fraction model to show the quotient; use the relationship between multiplication and division to explain that $(\frac{2}{3}) \div (\frac{3}{4}) = \frac{8}{9}$ because $\frac{3}{4}$ of $\frac{8}{9}$ is $\frac{2}{3}$. (In general, $(\frac{a}{b}) \div (\frac{c}{d}) = \frac{ad}{bc}$.) How much chocolate will each person get if 3 people share $\frac{1}{2}$ lb of chocolate equally? How many $\frac{3}{4}$ -cup servings are in $\frac{2}{3}$ of a cup of yogurt? How wide is a rectangular strip of land with length $\frac{3}{4}$ mi and area $\frac{1}{2}$ square mi?

Guiding Questions with Connections to Mathematical Practices:

How can the relationship between multiplication and division be used to solve fraction division problems?

M.P.7. Look for and make use of structure. Explain how to use the concepts of multiplication and division to solve fraction division problems and interpret the quotient. For example, when solving $\frac{3}{4} \div \frac{2}{3}$, relate it to “How many $\frac{2}{3}$ are in $\frac{3}{4}$?” or $\frac{3}{4} = a \times \frac{2}{3}$. Additionally, conceptualize the relationships between dividend, divisor, and quotient in a division problem by rewriting the problem using multiplication.

- Ask students to identify all the relationships within a fact family comprised of integers. For example: $3 \times 4 = 12$, $4 \times 3 = 12$, $12 \div 3 = 4$, and $12 \div 4 = 3$. Then, create a fact family using proper fractions to mirror those same relationships. For example: $\frac{1}{3} \times \frac{1}{4} = \frac{1}{12}$,

$\frac{1}{4} \times \frac{1}{3} = \frac{1}{12}$, $\frac{1}{12} \div \frac{1}{3} = \frac{1}{4}$, and $\frac{1}{12} \div \frac{1}{4} = \frac{1}{3}$. Use these relationships to illustrate dividing across.

- Ask students to rewrite a fraction division problem with an unknown as a fraction multiplication problem with an unknown. Then, use the multiplication problem to help solve the division problem. For example, the mixed-number division problem $4\frac{1}{2} \div ? = 3\frac{3}{5}$ can be rewritten as $3\frac{3}{5} \times ? = 4\frac{1}{2}$ or as $? \times 3\frac{3}{5} = 4\frac{1}{2}$. Then, the mixed numbers can be changed to improper fractions and rewritten as $? \times \frac{18}{5} = \frac{9}{2}$. Finally, both sides of the equation can be divided by $\frac{18}{5}$ to determine that $\frac{5}{4} \times \frac{18}{5} = \frac{9}{2}$.

How can visual fraction models and context be used to solve fraction division problems?

M.P.4. Model with mathematics. Represent the quotient of two fractions with a visual model and/or context. For example, model $\frac{1}{2} \div \frac{1}{8}$ with the context of “Marco has $\frac{1}{2}$ of a pound of crackers. He makes bags of crackers that each weigh $\frac{1}{8}$ of a pound. How many bags of crackers does Marco make?” Use a tape diagram divided into eighths. Shade $\frac{1}{2}$ of the tape diagram, and then find the number of eighths that are in $\frac{1}{2}$, which is 4. Additionally, use fraction models to visually represent the quotient of two fractions or the quotient of an integer and a fraction.

- To model and determine a quotient such as $3\frac{1}{3} \div \frac{2}{3}$, ask students to first represent the number $3\frac{1}{3}$ using fraction models with shading.

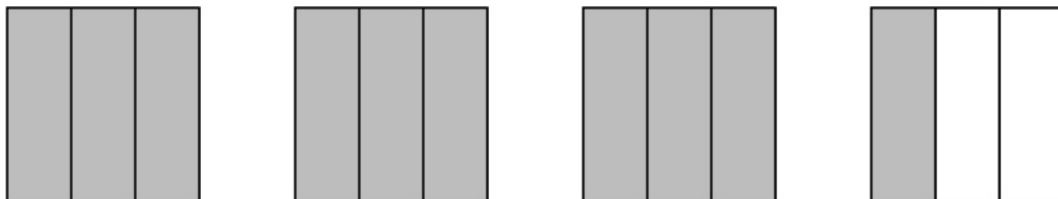

The shaded sections of the models can then be rearranged to show groups of size $\frac{2}{3}$. Finally, count the total number of groups to conclude that $3\frac{1}{3} \div \frac{2}{3} = 5$.

- Provide students with a tape diagram that illustrates the quotient of two fractions.

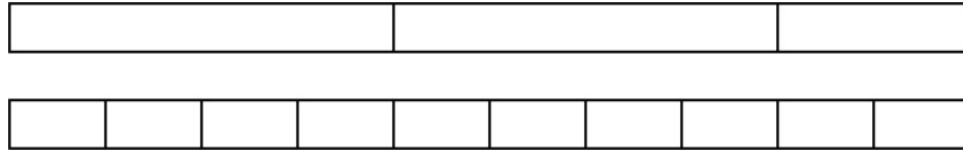

Ask students to interpret what the top row and the bottom row represent. In this case, the top row indicates the fraction $2\frac{1}{2}$ while each section in the bottom row indicates the fraction $\frac{1}{4}$. As such, the diagram illustrates $2\frac{1}{2}$ divided into groups of $\frac{1}{4}$. Therefore, $2\frac{1}{2} \div \frac{1}{4} = 10$.

How are remainders interpreted in fraction division?

M.P.6. Attend to precision. Explain how the unit changes in fraction division and how that impacts the meaning of a remainder. For example, when solving $3\frac{1}{2} \div \frac{3}{4}$, shade $3\frac{1}{2}$ circles, where 1 circle is 1 unit. Then, split each circle into fourths. Now, $\frac{3}{4}$ is the unit, so every 3 of the $\frac{1}{4}$ -sized parts is 1 unit. There are 4 full units, with 2 remaining out of 3 parts, so the solution is $4\frac{2}{3}$. Additionally, use fraction models to visually represent the quotient of two fractions, paying special attention to the remaining model sections that do not complete a unit. Further, create a simple contextual problem involving fraction division that can be solved and interpreted using common measuring devices.

- To model, determine, and interpret the remainder of $3\frac{1}{6} \div \frac{1}{3}$, ask students to represent the dividend of $3\frac{1}{6}$ using fraction models with shading.

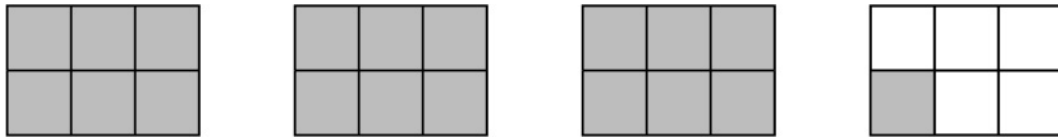

Then, ask students to represent the divisor of $\frac{1}{3}$ using the shaded sections from the fraction models.

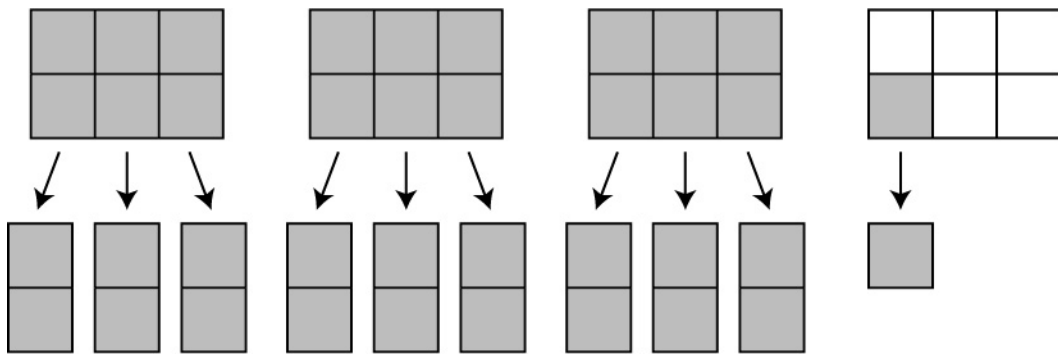

The division of $3\frac{1}{6} \div \frac{1}{3}$ is asking how many groups of size $\frac{1}{3}$ are in $3\frac{1}{6}$. The unit is now one group of size $\frac{1}{3}$ instead of one full fraction model. There are 9 whole units of size $\frac{1}{3}$ in $3\frac{1}{6}$ with $\frac{1}{6}$ of a fraction model remaining. While the size of the remainder is $\frac{1}{6}$ of a fraction model, the $\frac{1}{6}$ is one-half the size of $\frac{1}{3}$, so the fraction part of the quotient is $\frac{1}{2}$. There are $9\frac{1}{2}$ units of size $\frac{1}{3}$ in $3\frac{1}{6}$.

- Demonstrate how to determine and interpret the remainder of $2\frac{3}{4} \div \frac{1}{3}$ by asking students to fill a container with $2\frac{3}{4}$ cups of water. Then, count how many times a $\frac{1}{3}$ -cup measuring device can be filled completely.

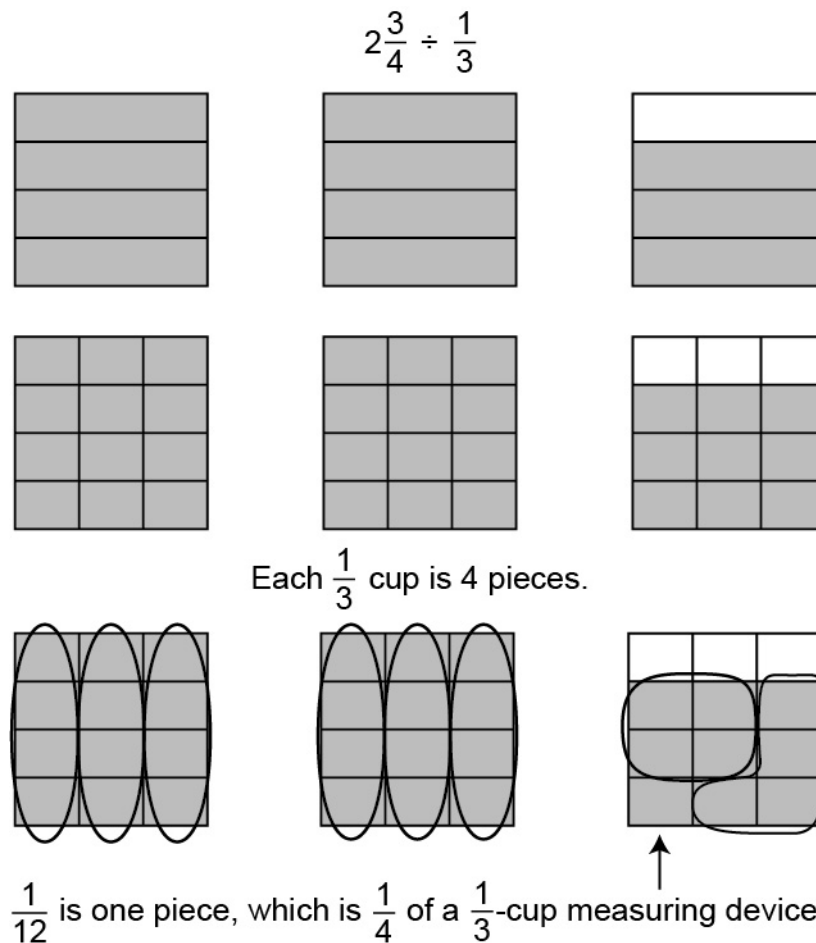

After filling the $\frac{1}{3}$ -cup measuring device 8 times, $\frac{1}{12}$ cup of water remains in the container. To determine the fraction part of the quotient, the amount of water remaining in the container needs to be measured in terms of the $\frac{1}{3}$ -cup measuring device. Because the remaining amount of water fills up $\frac{1}{4}$ of the $\frac{1}{3}$ -cup measuring device, the full quotient is $8\frac{1}{4}$.

Why does multiplying by the reciprocal work when dividing fractions?

M.P.2. Reason abstractly and quantitatively. Develop, explain, and use the multiplying by the reciprocal rule, which states that dividing by a number is equivalent to multiplying by the reciprocal of that number, by using a variety of contexts and strategies, such as finding a common denominator and dividing across and the knowledge that fractions are division. For example, the quotient of $\frac{3}{4}$ and $\frac{2}{5}$ can be found by finding a common denominator and dividing across:

$\frac{15}{20} \div \frac{8}{20} = \frac{15 \div 8}{20 \div 20} = \frac{15 \div 8}{1} = \frac{15}{8}$. Connect the process to using reciprocals to find a denominator of one

to show why invert and multiply works, as in the following example: $\frac{\frac{3}{4} \times \frac{5}{2}}{\frac{2}{5} \times \frac{5}{2}} = \frac{\frac{15}{8}}{1} = \frac{15}{8}$. Additionally,

connect the process to multiplication by scaling up and then dividing.

- To determine $2 \div \frac{2}{5}$, ask students to divide two candy bars into 5 parts and circle groups of size $\frac{2}{5}$, as shown in the diagram.

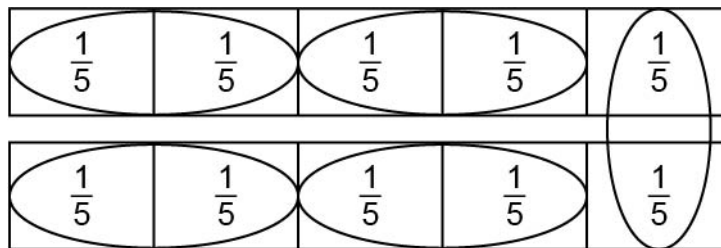

There are 5 groups of size $\frac{2}{5}$, so the quotient is 5. Another way to approach the division is to recognize that dividing the candy bars into five parts multiplies the number of items being divided by 5. There are now 10 pieces to divide that are each $\frac{1}{5}$ of a candy bar. Ask students to divide the candy into groups of size $\frac{2}{5}$, which is the same as groups of 2 pieces. Dividing 10 pieces into groups of 2 pieces yields 5 groups. That is, $2 \times 5 \div 2 = 2 \times \frac{5}{2} = \frac{10}{2} = 5$.

Therefore, $2 \div \frac{2}{5} = 2 \times \frac{5}{2}$.

- Ask students to create fractions that are equivalent to $\frac{2}{3}$ by multiplying both the numerator and denominator by the same whole number. Then, ask students to create fractions that are equivalent to $\frac{2}{3}$ by multiplying both the numerator and denominator by the same fraction. Note that they have created a complex fraction that is equivalent to $\frac{2}{3}$. Also, note that just as a simple fraction represents division of two whole numbers, a complex fraction represents division of two fractions. Then, ask students to create a complex fraction that is equivalent to $\frac{1}{\frac{5}{3}}$ by multiplying both the numerator and denominator by the same fraction.

Challenge them to find a multiplier that results in a simple fraction. Finally, ask students to demonstrate why the general rule $\left(\frac{a}{b}\right) \div \left(\frac{c}{d}\right) = \frac{ad}{bc}$ is true by rewriting the expression

$\left(\frac{a}{b}\right) \div \left(\frac{c}{d}\right)$ as a complex fraction. For example, the expression $\left(\frac{a}{b}\right) \div \left(\frac{c}{d}\right)$ can be rewritten as $\frac{\frac{a}{b}}{\frac{c}{d}}$.

If both the numerator and denominator are multiplied by the reciprocal of $\left(\frac{c}{d}\right)$, then the

denominator of the complex fraction becomes 1 because $\frac{\frac{a}{b}}{\frac{c}{d}} \times \frac{d}{c} = \frac{\frac{ad}{bc}}{\frac{cd}{cd}} = \frac{\frac{ad}{bc}}{1}$. Since $\frac{ad}{bc}$ can

be rewritten as $\frac{ad}{bc}$, then it can be concluded that the general rule $\left(\frac{a}{b}\right) \div \left(\frac{c}{d}\right) = \frac{ad}{bc}$ is true.

Key Academic Terms:

reciprocal, fraction model, unit

Additional Resources:

- Video: [Relationship of division and fractions](#)
- Lesson: [Dividing fractions within word problems](#)
- Lesson: [Dividing fractions](#)

The Number System
Compute fluently with multi-digit numbers and find common factors and multiples.
5 Fluently divide multi-digit numbers using the standard algorithm.

Guiding Questions with Connections to Mathematical Practices:

How are division algorithms related to each other?

M.P.8. Look for and express regularity in repeated reasoning. Develop the standard algorithm by looking for general methods from a concrete model and connecting the algorithm to partial quotients or other strategies, and evaluate the reasonableness of the solution. For example, use the standard algorithm to solve $336 \div 4$, and evaluate the accuracy of the solution by using estimation or by multiplying the quotient by the divisor. Additionally, perform the standard division algorithm by including the zeros for each place value.

- Ask students to solve the same division problem using partial quotients and the standard algorithm, noting the corresponding steps between the methods. For example, the quotient of 861 and 7 can be solved using either method shown.

Partial Quotients

$$\begin{array}{r}
 7 \overline{) 861} \\
 \underline{- 700} \\
 161 \\
 \underline{- 140} \\
 21 \\
 \underline{- 21} \\
 0
 \end{array}
 \begin{array}{l}
 \times 100 \\
 \times 20 \\
 \times 3
 \end{array}$$

Standard Algorithm

$$\begin{array}{r}
 3 \\
 20 \\
 100 \\
 7 \overline{) 861} \\
 \underline{- 700} \\
 161 \\
 \underline{- 140} \\
 21 \\
 \underline{- 21} \\
 0
 \end{array}$$

Both methods illustrate that the resulting quotient of 123 is derived from the sum of $100 + 20 + 3$.

- Ask students to solve the same division problem using an area model and the standard algorithm. For example, the quotient of 143 and 11 can be solved using either method shown.

Area Model	Standard Algorithm															
$143 \div 11$																
<table border="1" style="margin-left: auto; margin-right: auto; border-collapse: collapse;"> <tr> <td style="padding: 5px;"></td> <td style="padding: 5px; text-align: center;">10</td> <td style="padding: 5px; text-align: center;">3</td> </tr> <tr> <td style="padding: 5px; text-align: right;">11</td> <td style="padding: 5px; text-align: center;">143</td> <td style="padding: 5px; text-align: center;">33</td> </tr> <tr> <td></td> <td style="padding: 5px; text-align: center;">- 110</td> <td style="padding: 5px; text-align: center;">- 33</td> </tr> <tr> <td></td> <td style="padding: 5px; text-align: center;">-----</td> <td style="padding: 5px; text-align: center;">-----</td> </tr> <tr> <td></td> <td style="padding: 5px; text-align: center;">33</td> <td style="padding: 5px; text-align: center;">0</td> </tr> </table>		10	3	11	143	33		- 110	- 33		-----	-----		33	0	$\begin{array}{r} 3 \\ 11 \overline{) 143} \\ \underline{- 110} \\ 33 \\ \underline{- 33} \\ 0 \end{array}$
	10	3														
11	143	33														
	- 110	- 33														
	-----	-----														
	33	0														
$10 + 3 = 13$																

Both the area model and the standard algorithm show that there is a total of 13 groups of 11 in 143.

How can a remainder be interpreted?

M.P.8. Look for and express regularity in repeated reasoning. Recognize that the remainder in a quotient can be expressed as the numerator of a fraction, with the divisor as the denominator. For example, dividing 334 by 5 is asking the question “How many groups of size 5 are in 334?” There are 66 groups of size 5 with 4 remaining. The remainder of 4 can be interpreted as $\frac{4}{5}$ of a group of size 5. Therefore, there are $66\frac{4}{5}$ groups of size 5 in 334. The 4 remaining could also be interpreted as 0.8 or 80% of a group. Additionally, illustrate the meaning of a remainder using models.

- Ask students to find the quotient with a remainder. For example, find the quotient of 55 and 20 by drawing 55 squares and creating as many groups of 20 squares as possible. Then, ask students to count the remaining squares that do not complete a group of 20. The remaining 15 squares represent 15 parts of a complete group of 20 squares. As such, the remainder of 15 represents $\frac{3}{4}$, and the quotient of 55 and 20 is $2\frac{3}{4}$.

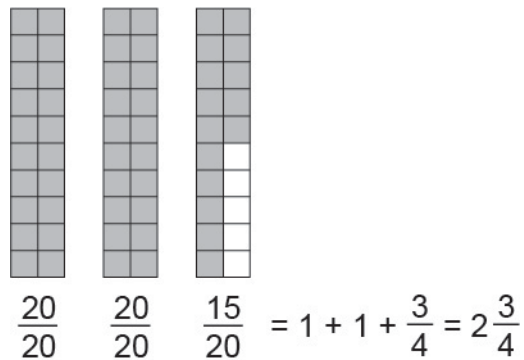

- Provide students with a context that involves a quotient with a remainder and ask students to draw and explain an illustration. Then, ask students to solve the same problem using the standard algorithm and relate the remainder to their illustration. For example, “Joe is placing stickers in a sticker book. He has 46 stickers and places 10 stickers on each page. How many pages can Joe fill?”



$$10 \overline{) 46} \begin{array}{r} 4 \text{ R } 6 \\ - 40 \\ \hline 6 \end{array} = 4\frac{6}{10} = 4\frac{3}{5}$$

Each page represents a group of 10 stickers. The 6 leftover stickers correspond to the remainder of 6 in the algorithm. The remainder represents a number of stickers. However, the 4 in the quotient represents a number of pages. In order to write the quotient as a single mixed number, a consistent unit needs to be represented. Create the fraction needed by converting 6 stickers into a number of pages, creating the fraction $\frac{6}{10}$.

Key Academic Terms:

standard algorithm, dividend, divisor, remainder, fraction, fluency, factors, multiples

Additional Resources:

- Video: [How can you use base-ten blocks when dividing?](#)
- Video: [Using base-ten blocks to divide long division](#)

The Number System

Compute fluently with multi-digit numbers and find common factors and multiples.

6 Fluently add, subtract, multiply, and divide multi-digit decimals using the standard algorithm for each operation.

Guiding Questions with Connections to Mathematical Practices:**How are operations with decimals similar to operations without decimals?**

M.P.7. Look for and make use of structure. Extend previous knowledge of strategies, including place value, models, and the standard algorithm, to perform operations with multi-digit decimals. For example, the product of 2.4 and 1.35 can be determined by representing the numbers as whole numbers by multiplying by powers of 10 so that $2.4 \times 10 \times 1.35 \times 100 = 24 \times 135$. Multiply to find that $24 \times 135 = 3,240$, and then determine the final product by dividing by 1,000 (based on the factors used to convert to whole numbers: $10 \times 100 = 1,000$) for a solution of 3.24. Additionally, use decimal grids to illustrate that there is a base-ten connection between decimals and whole numbers.

- Ask students to find the difference of two whole numbers and relate it to the difference of decimal numbers. For example, start with the difference of 56 and 12. Note that when 12 ones are taken away from 56 ones, the result is 44 ones. Then, ask students to create a decimal grid that represents 0.56. Instruct students to cross off 12 hundredths and count the remaining hundredths. Emphasize that just as the difference of 56 ones and 12 ones is 44 ones, so too the difference of 56 hundredths and 12 hundredths is 44 hundredths.

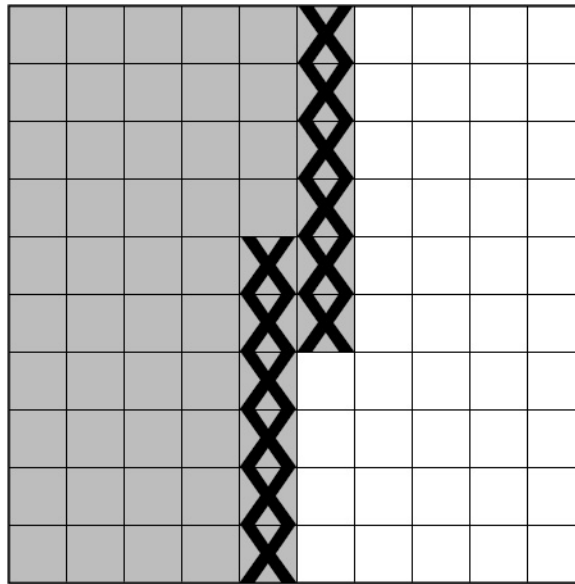

- Ask students to identify the product of 3 and 7. Then, ask students to determine the product of 0.3 and 0.7 using a decimal grid where 3 shaded rows represent 0.3 and 7 shaded columns represent 0.7.

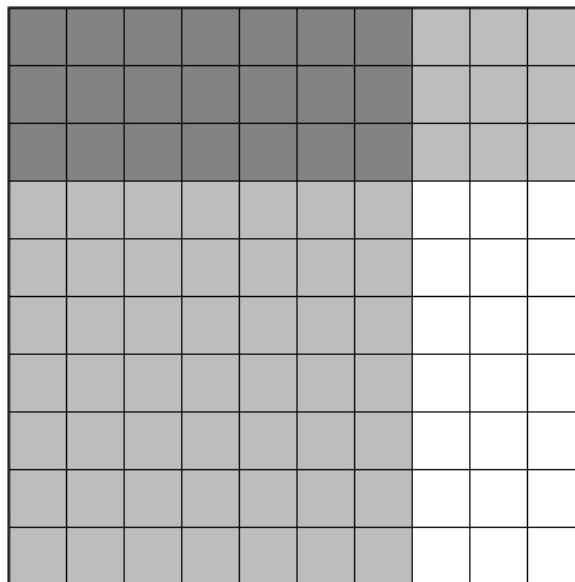

Count the total number of squares that are covered by both the shaded rows and the shaded columns to conclude that the product of 0.3 and 0.7 is $\frac{21}{100}$ or 0.21. Note that just as $3 \times 7 = 21$, so too $0.3 \times 0.7 = 0.21$.

How can fractions be used to show that the standard algorithms for multiplication and division work with multi-digit decimals?

M.P.2. Reason abstractly and quantitatively. Verify that when numbers with multi-digit decimals are rewritten as fractions, the same products and quotients are generated as when using the standard algorithms. For example, when multiplying 2.4×1.35 , 2.4 can be represented as $\frac{24}{10}$ and 1.35 can be represented as $\frac{135}{100}$. Therefore, 2.4×1.35 can be rewritten as $\frac{24}{10} \times \frac{135}{100} = \frac{3,240}{1,000} = 3.240$. Additionally, use visual representations of decimals and their corresponding fractions to confirm products and quotients determined using the standard algorithms.

- Ask students to find the quotient of 0.75 and 0.15 using the standard algorithm. Then, ask students to represent 0.75 on a decimal grid by shading $\frac{75}{100}$ of the grid. Next, ask students to divide the shaded area into groups representing $\frac{15}{100}$. Finally, ask students to count the total number of groups created (which is 5, as shown by the diagram), noting that it corresponds to the quotient determined by the standard algorithm.

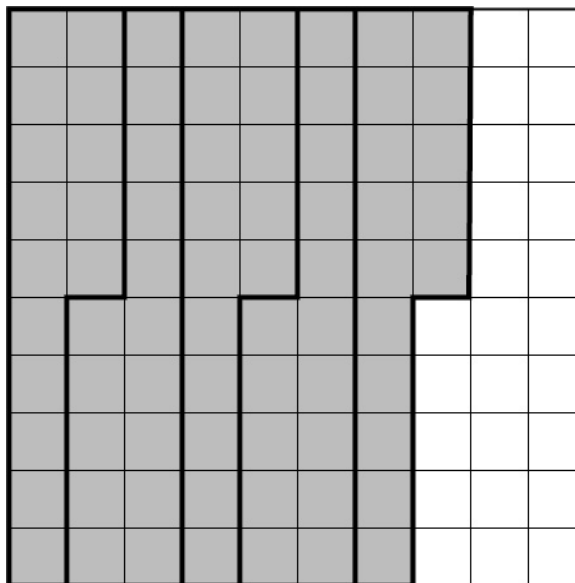

- Ask students to find the product of 0.125 and 0.25 using the standard algorithm.

$$\begin{array}{r}
 0.125 \\
 \times 0.25 \\
 \hline
 625 \\
 2500 \\
 \hline
 0.03125
 \end{array}$$

Then, ask students to convert 0.125 and 0.25 to fractions so that the product can be determined using an area model. Ask students to divide a rectangle into four equal-sized rows and shade one row to represent $\frac{1}{4}$.

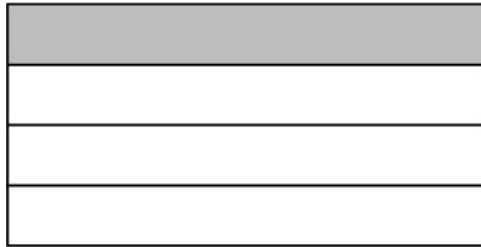

Then, ask students to also divide the same rectangle into eight equal-sized columns and shade one column to represent $\frac{1}{8}$.

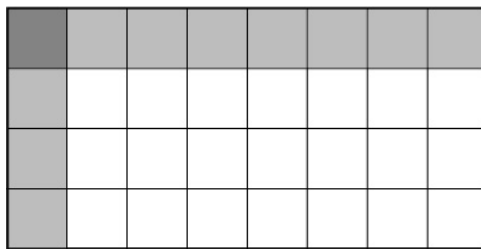

The common shading of the rectangle represents $\frac{1}{32}$ of the total rectangle, which is equivalent to 0.03125.

Key Academic Terms:

standard algorithm, operations, decimals, fractions, fluency, factors, multiples

Additional Resources:

- Video: [Add & subtract decimals](#)
- Video: [Multiplying decimals](#)

The Number System

Compute fluently with multi-digit numbers and find common factors and multiples.

7 Find the greatest common factor of two whole numbers less than or equal to 100 and the least common multiple of two whole numbers less than or equal to 12. Use the distributive property to express a sum of two whole numbers 1-100 with a common factor as a multiple of a sum of two whole numbers with no common factor.

Example: Express $36 + 8$ as $4(9 + 2)$.

Guiding Questions with Connections to Mathematical Practices:

How are the greatest common factor and the distributive property used to rewrite a sum as a product?

M.P.7. Look for and make use of structure. Recognize that if the greatest common factor of two addends is identified, then each addend can be rewritten as a product that includes the greatest common factor and that the distributive property can then be applied to express the original sum as a multiple of the sum of two whole numbers with no common factor. For example, the numerical expression $8 + 14$ can be rewritten as $2 \times 4 + 2 \times 7$, which is equivalent to $2(4 + 7)$ after applying the distributive property. This is useful to make mental calculations easier, by adding 4 and 7 together and then doubling the sum. Additionally, use visual models to illustrate how the sum of two whole numbers can be rewritten using the greatest common factor as a multiple of a sum of two whole numbers without a common factor.

- Ask students to identify the greatest common factor of the addends 6 and 8 (i.e., 2). Then, ask students to first represent 6 as a rectangle with width 2 and length 3 and then 8 as a rectangle with width 2 and length 4.

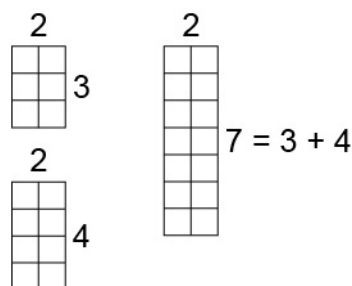

Emphasize that the sum of the areas of the two rectangles $[6 + 8]$ is equivalent to the width of the rectangles multiplied by the sum of the lengths of the rectangles $[2(3 + 4)]$.

- Ask students to use simple objects or drawings to illustrate how a sum can be rewritten as a product. For example, provide students with 16 paperclips and ask them to create a group of 6 paperclips (2×3 array) and a group of 10 paperclips (2×5 array).

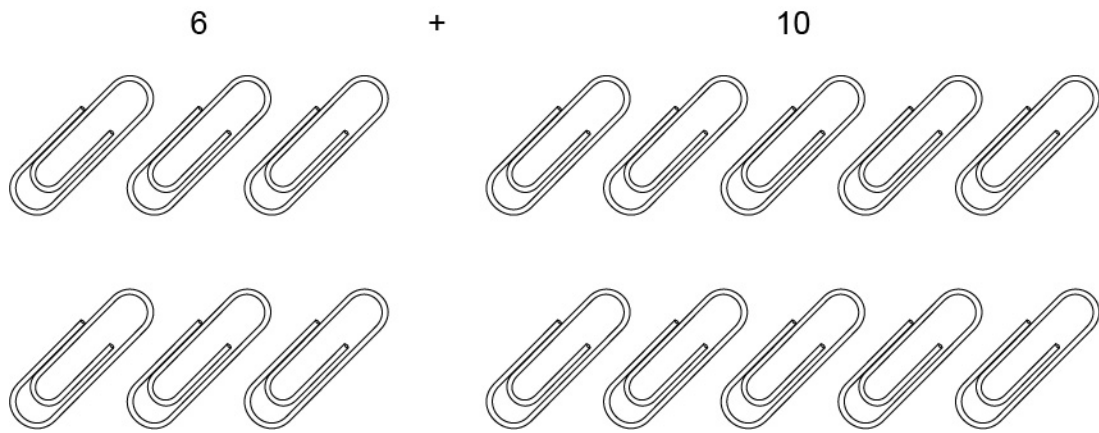

After identifying the greatest common factor of 6 and 10 as 2, ask students to use an object like a pencil as a horizontal line to divide each group of paperclips into 2 equal parts.

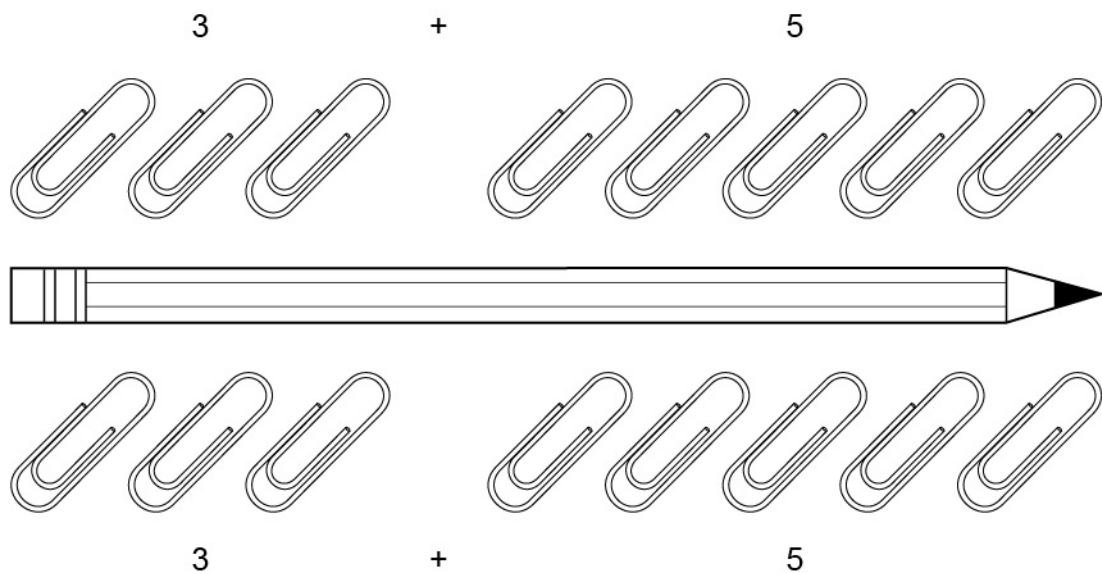

Highlight that the horizontal line has now created 2 groups of 3 and 5. As such, the expression $6 + 10$ is equivalent to the expression $2(3 + 5)$.

How can the greatest common factor of two whole numbers be determined without listing all the factors of both numbers?

M.P.1. Make sense of problems and persevere in solving them. Recognize that the greatest common factor of two whole numbers can be determined using a variety of methods such as prime factorization or a ladder diagram. For example, the greatest common factor of 12 and 16 can be determined by first writing the prime factorization of 12 and 16, and then identifying the prime factors that both numbers have in common (e.g., $12 = 2 \times 2 \times 3$ and $16 = 2 \times 2 \times 2 \times 2$; therefore, the greatest common factor of 12 and 16 is 2×2 or 4). Additionally, recognize that if two whole numbers are prime, then the greatest common factor is necessarily 1. Further, recognize that if the greatest common factor of any two whole numbers is one, then the two numbers are relatively prime.

- Ask students to determine the greatest common factor of two numbers using a ladder diagram. For example, the greatest common factor of 72 and 88 can be determined by first dividing both numbers by the common factor 4, and then dividing each resulting quotient by the common factor 2. Because there are no common factors of 9 and 11 other than 1, it can be concluded that the greatest common factor of 72 and 88 is 8 because $4 \times 2 = 8$.

$$\begin{array}{r|l}
 4 & 72 \quad 88 \\
 \hline
 2 & 18 \quad 22 \\
 \hline
 & 9 \quad 11 \\
 & 4 \times 2 = 8
 \end{array}$$

- Provide students with 2 distinct prime numbers and ask them to explain why the greatest common factor must be 1. Students should be able to articulate that every prime number has only two factors: 1 and itself. As such, the greatest (and only) common factor of two prime numbers must be 1. For example, the only factors of 7 are 1 and 7 while the only factors of 11 are 1 and 11. Therefore, 7 and 11 are relatively prime.

Key Academic Terms:

greatest common factor, prime factorization, least common multiple, distributive property

Additional Resources:

- Lesson: [Exploring number patterns to discover common factors](#)
- Lesson: [Factoring out the greatest](#)
- Lesson: [Multiples, LCM, and GCF](#)

The Number System

Apply and extend previous understandings of numbers to the system of rational numbers.

8 Understand that positive and negative numbers are used together to describe quantities having opposite directions or values (e.g., temperature above/below zero, elevation above/below sea level, credits/debits, positive/negative electric charge); use positive and negative numbers to represent quantities in real-world contexts explaining the meaning of 0 in each situation.

Guiding Questions with Connections to Mathematical Practices:

How do positive and negative numbers relate to 0?

M.P.2. Reason abstractly and quantitatively. Recognize that positive numbers are greater than 0 and may be represented with a (+) symbol or no symbol while negative numbers are less than 0 and are represented with a (-) symbol. For example, 4 is a positive number because it is 4 greater than 0, and -5 is a negative number because it is 5 less than 0. Additionally, recognize that although a negative number is less than 0, it might be further away from 0 than a positive number.

- Ask students to draw a horizontal number line with 9 tick marks that are evenly spaced. Then, ask students to label the center tick mark as “0.”

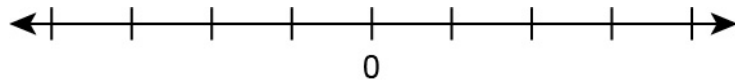

Provide students with an integer between -4 and 4 and then ask them to determine on which side of 0 it is located and which tick mark represents that integer. For example, the number -3 is located 3 tick marks to the left of 0 while 2 is located 2 tick marks to the right of 0.

- Provide students with two numbers that are opposites and ask them to identify on which side of 0 each is located. Observe that if one number is positive, then its opposite is negative, and vice versa. For example, given the numbers -13 and 13, the former is to the left of 0 and the latter is to the right of 0.

What are opposites and how do they relate to 0?

M.P.2. Reason abstractly and quantitatively. Recognize that two numbers are opposites if they are the same distance from 0 and on different sides of 0. For example, -9 and 9 are opposites because they are both 9 away from 0 on a number line. Additionally, recognize that all numbers have exactly one opposite.

- Provide students with a piece of paper that has a horizontal number line with tick marks and labels from -3 to 3 .

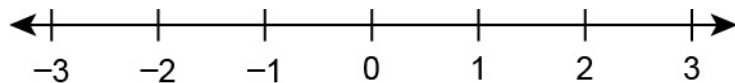

Then, ask students to fold the paper in half so that a vertical line passes through the point 0 on the number line. Emphasize that the folded line is a line of symmetry and that each point on the right has one opposite, or matching, point on the left.

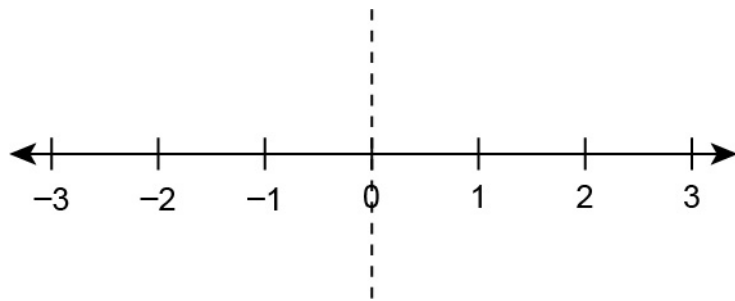

- Provide students with different integers and ask them to identify and plot the opposite of each on a number line. For example, given the integers -2 , 4 , and -6 , students should be able to identify the opposites as 2 , -4 , and 6 , and then plot each of those opposites on a number line. Emphasize that each number and its opposite are the same distance from 0.

How does context change the interpretation of zero in problems with positive and negative numbers?

M.P.6. Attend to precision. Explain the meaning of zero when given a context. For example, zero in the context of money means “none,” whereas zero given the context of sea level does not mean “none” but refers instead to a location. Additionally, identify how opposites relate to zero within a context.

- Ask students to use number lines with labels to create visual representations of the meaning of zero within a context. For example, a vertical number line with the point zero labeled as “sea level” could be used to illustrate a context involving altitude.

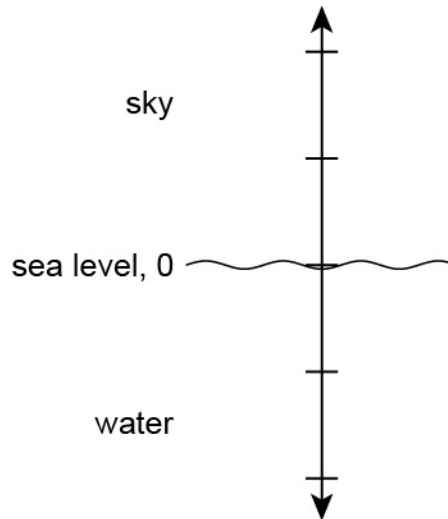

- Provide students with a context and ask them to explain the meaning of opposites in relation to zero. For example, “ 10°C is 10 degrees warmer than the temperature at which water freezes, while -10°C is 10 degrees colder than the temperature at which water freezes.”

Key Academic Terms:

positive number, negative number, opposites

Additional Resources:

- Video: [Integers—How do positive and negative numbers relate to sea level?](#)
- Video: [Integers—How do positive and negative numbers relate to temperature?](#)

The Number System

Apply and extend previous understandings of numbers to the system of rational numbers.

9 Understand a rational number as a point on the number line. Extend number line diagrams and coordinate axes familiar from previous grades to represent points on the line and in the plane with negative number coordinates.

9a Recognize opposite signs of numbers as indicating locations on opposite sides of 0 on the number line; recognize that the opposite of the opposite of a number is the number itself, e.g., $-(-3) = 3$, and that 0 is its own opposite.

Guiding Questions with Connections to Mathematical Practices:**What are opposites and how are they represented on a number line?**

M.P.4. Model with mathematics. Represent a number and its opposite by showing that they are the same distance from 0 on a number line. For example, -2 and 2 are opposite numbers because they are both 2 units away from the point 0 on a number line. Additionally, recognize that 0 is the only number that is its own opposite.

- Provide students with a point that is plotted on a number line and ask them to plot the opposite.
- Provide students with a number and ask them to plot both the number and its opposite. Emphasize that both plotted points are the same distance from 0.
- Ask students to explain why it only requires one point to graph 0 and its opposite while it requires two points to graph any other number and its opposite. Students should be able to articulate that 0 is its own opposite.

What is the significance of the opposite of a number's opposite?

M.P.2. Reason abstractly and quantitatively. Recognize that the opposite of a number's opposite is the same as the number itself. For example, the opposite of 3 is -3 , and the opposite of -3 is 3. Therefore, the opposite of the opposite of 3 is 3. Additionally, use non-numeric opposites to illustrate why the opposite of an opposite is the original entity, state, or location.

- Create a number line on the floor using masking tape and ask a student to stand at the point -5 . Then, ask the student to move to the opposite point on the number line, namely 5 . Then, ask the student to move to the point opposite of 5 , noting that the student is now at the original location. Point out to students that the negative symbol translates into “the opposite of.” Therefore, -5 means the opposite of 5 . Ask students to explain why $-(-5) = 5$. Help students to conclude that $-(-5)$ means the opposite of the opposite of 5 , which is 5 . Adding a third negative asks the student to take the opposite yet again, resulting in a value of -5 .
- Use a classroom light switch to illustrate why the opposite of the opposite is the original state. For example, with the light switch in the “on” position, ask students what the opposite of “on” is, namely “off.” Turn the lights off. Then, ask students what the opposite of “off” is, namely “on.” Turn the lights on. As such, the opposite of the opposite of “on” is “on.”

Key Academic Terms:

opposites, number line, rational number

Additional Resources:

- Activity: [Distance on the number line](#)
- Lesson: [Understanding integers](#)
- Lesson: [A concrete introduction to the abstract concepts of integers and algebra using algebra tiles](#)

The Number System

Apply and extend previous understandings of numbers to the system of rational numbers.

9 Understand a rational number as a point on the number line. Extend number line diagrams and coordinate axes familiar from previous grades to represent points on the line and in the plane with negative number coordinates.

9b Understand signs of numbers in ordered pairs as indicating locations in quadrants of the coordinate plane; recognize that when two ordered pairs differ only by signs, the locations of the points are related by reflections across one or both axes.

Guiding Questions with Connections to Mathematical Practices:

What is the relationship between the signs of the coordinates of an ordered pair and the quadrant location of the ordered pair on the coordinate plane?

M.P.2. Reason abstractly and quantitatively. Recognize that the coordinate plane is divided into four quadrants created by the intersection of a horizontal line, the x -axis, and a vertical line, the y -axis, and that the signs of an ordered pair determine the quadrant location, such that $(+, +)$ represents quadrant I, $(-, +)$ represents quadrant II, $(-, -)$ represents quadrant III, and $(+, -)$ represents quadrant IV. For example, the ordered pair $(-2, 2)$ is in quadrant II. Additionally, recognize that the sign of the first nonzero number in the ordered pair indicates a location that is to the left or right of the y -axis while the sign of the second nonzero number in the ordered pair indicates a location that is above or below the x -axis.

- Provide students with an ordered pair and ask them to identify in which quadrant the point is located without actually graphing it. For example, students should be able to locate the ordered pair $(3, -2)$ in quadrant IV.

- Provide students with a number and ask them to create an ordered pair in each of the four quadrants using only the number and its opposite. For example, given the number 4, students should be able to locate $(4, 4)$ in quadrant I, $(-4, 4)$ in quadrant II, $(-4, -4)$ in quadrant III, and $(4, -4)$ in quadrant IV.

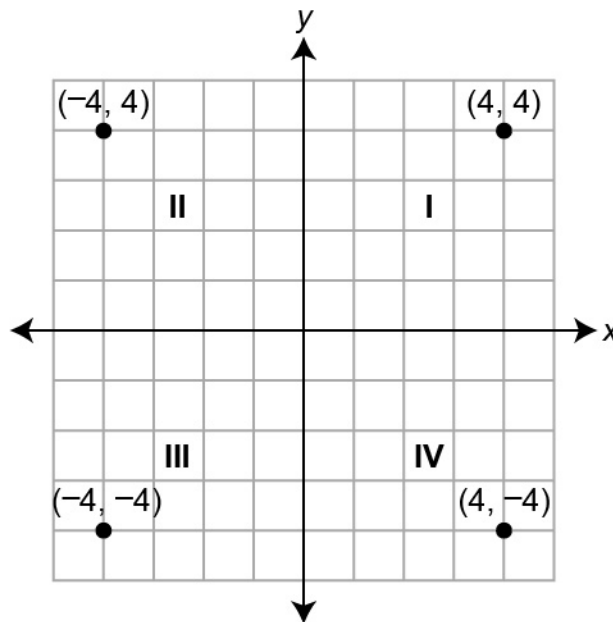

How is the location of an ordered pair affected when the sign of either coordinate is changed?

M.P.2. Reason abstractly and quantitatively. Recognize that changing the sign of the x -coordinate in an ordered pair results in a location that is a reflection across the y -axis, while changing the sign of the y -coordinate results in a location that is a reflection across the x -axis. For example, the ordered pair $(-3, 5)$ is a reflection across the y -axis of the ordered pair $(3, 5)$. Additionally, recognize that changing the sign of both the x -coordinate and the y -coordinate results in a location that is a reflection across both axes.

- Provide students with an ordered pair and ask them to identify a corresponding ordered pair that represents a reflection across one or both axes. For example, when given the ordered pair $(7, 8)$, students should be able to identify the ordered pair $(-7, 8)$ as a reflection across the y -axis.

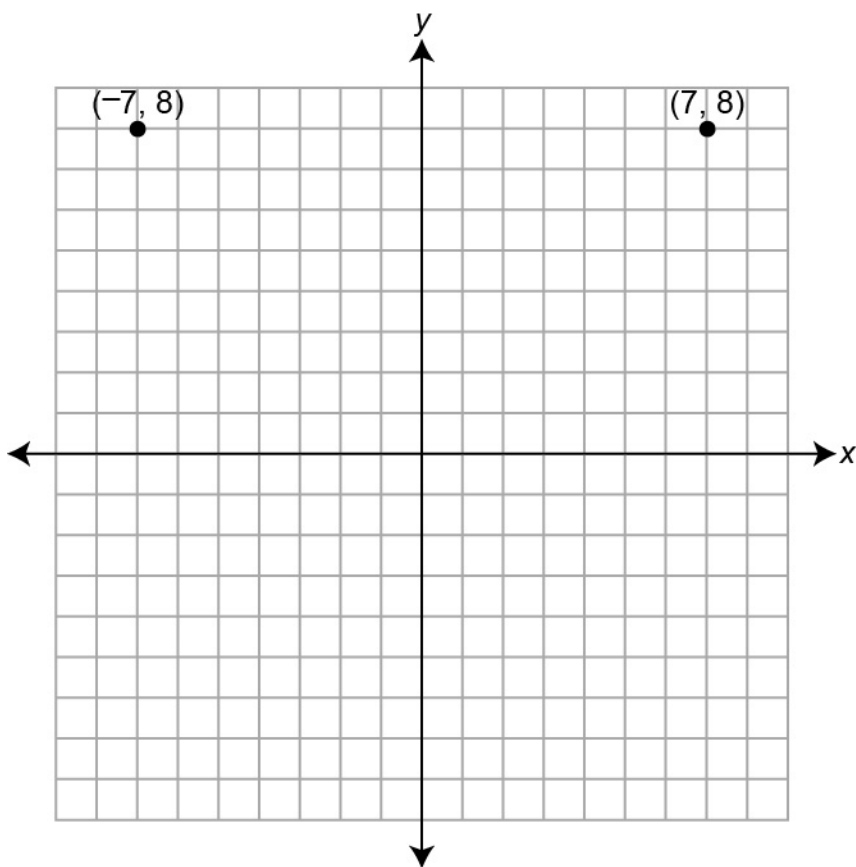

- Provide students with two ordered pairs and ask them to identify how they are related. For example, given the ordered pairs $(-6, -4)$ and $(-6, 4)$, students should be able to recognize that the second ordered pair is a reflection across the x -axis of the first ordered pair.

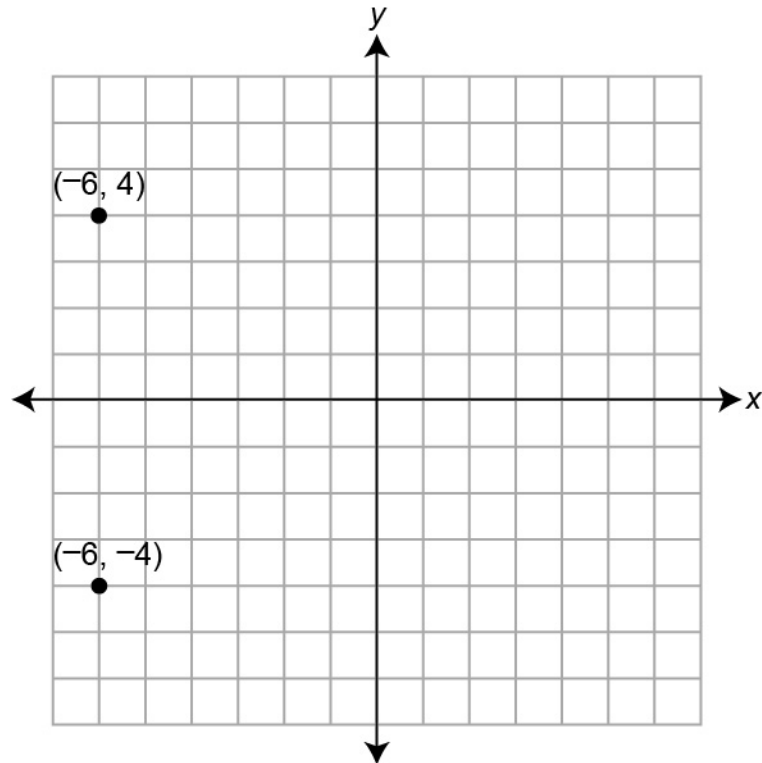

How does the number 0 in an ordered pair affect the location of the ordered pair?

M.P.2. Reason abstractly and quantitatively. Recognize that when one of the coordinates in an ordered pair is 0, then the location of the ordered pair is on an axis. For example, the ordered pair $(0, 4)$ represents a point that is 4 units above the origin on the y -axis. Additionally, recognize that ordered pairs that are located on an axis are not in a quadrant. Further, when both numbers in the ordered pair are 0, the ordered pair is located at the origin.

- Provide students with an ordered pair that includes a 0 and ask them to determine its location. For example, students should be able to determine that the ordered pair $(-11, 0)$ is located to the left of the origin on the x -axis.

- Provide students with an ordered pair that includes a 0 and ask them to explain why reflecting the point across one axis results in a new point. Also ask them to explain why reflecting the point across the other axis will not result in a new point. For example, students should be able to recognize that the ordered pair $(-3, 0)$ creates a new point when reflected across the y -axis but not when reflected across the x -axis because $(-3, 0)$ is located on the x -axis.

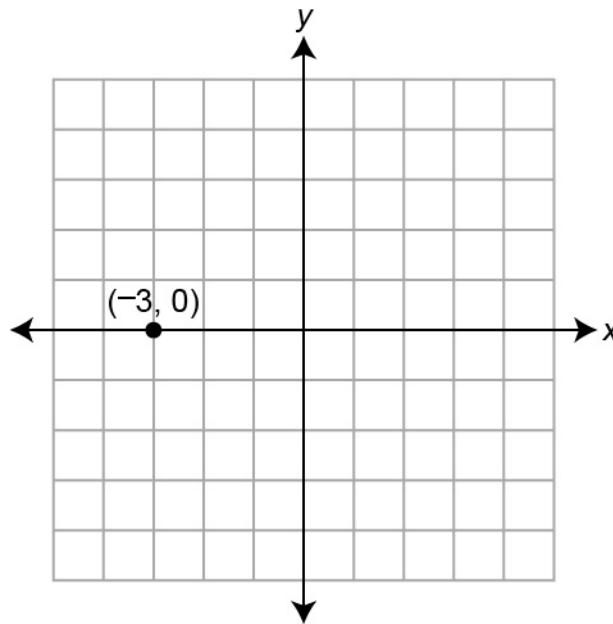

Key Academic Terms:

quadrant, coordinate plane, ordered pair, sign, y -axis, x -axis, axis, origin, rational number

Additional Resources:

- Video: [Coordinate plane | 4 quadrants](#)
- Lesson: [Graphing integers on the coordinate grid](#)
- Activity: [Graphing ordered pairs of rational numbers](#)

The Number System

Apply and extend previous understandings of numbers to the system of rational numbers.

9 Understand a rational number as a point on the number line. Extend number line diagrams and coordinate axes familiar from previous grades to represent points on the line and in the plane with negative number coordinates.

9c Find and position integers and other rational numbers on a horizontal or vertical number line diagram; find and position pairs of integers and other rational numbers on a coordinate plane.

Guiding Questions with Connections to Mathematical Practices:

What is the relationship between the sign of a number and its location on a vertical or horizontal number line?

M.P.2. Reason abstractly and quantitatively. Recognize that negative numbers are located below zero on a vertical number line or to the left of zero on a horizontal number line, while positive numbers are located above zero on a vertical number line or to the right of zero on a horizontal number line. For example, the number $-\frac{3}{4}$ is located $\frac{3}{4}$ of a unit below zero on a vertical number line or $\frac{3}{4}$ of a unit left of zero on a horizontal number line. Additionally, recognize that if a number is left of 0 on a horizontal number line, then the same number is below 0 on a vertical number line. Further, if a number is right of 0 on a horizontal number line, then the same number is above 0 on a vertical number line.

- Provide students with a rational number and ask them to plot it on both a horizontal number line and a vertical number line. Then, ask students to explain how the location of the number changes when the sign changes.
- Provide students with a list of rational numbers and ask them to identify which numbers are located on the same side of 0 on either a horizontal number line or a vertical number line. For example, given the numbers -6 , 0.6 , 66 , $-\frac{6}{7}$, -67 , and $6\frac{6}{7}$, students should be able to articulate that -6 , $-\frac{6}{7}$, and -67 are below 0 on a vertical number line while 0.6 , 66 , and $6\frac{6}{7}$ are located above 0 on a vertical number line.

What is the relationship between the signs of coordinates in an ordered pair and the location of an ordered pair on the coordinate plane?

M.P.2. Reason abstractly and quantitatively. Recognize that the first coordinate, also called the x -value, in an ordered pair indicates how far to move to the left (negative) or right (positive) from the origin, while the second coordinate, known as the y -value, indicates how far to move down (negative) or up (positive) from the origin. For example, the ordered pair $(-3, 5.5)$ indicates a location that is 3 units left of the origin and 5.5 units up. Additionally, recognize that if the sign of the x -value of an ordered pair is changed, then the location of the new point is a reflection across the y -axis. Further, if the sign of the y -value of an ordered pair is changed, then the location of the new point is a reflection across the x -axis.

- Provide students with several ordered pairs (including ordered pairs that differ only by sign) and ask them to plot the ordered pairs on a coordinate plane.
- Provide students with an ordered pair and ask them to determine a corresponding ordered pair that represents a reflection across an axis. For example, provide students with the ordered pair $(-9, 4)$ and ask them to determine the ordered pair that represents a reflection across the y -axis, namely $(9, 4)$. Observe from this that reflecting a point across the x -axis changes the point in a vertical direction. Therefore, the x -coordinate will stay the same and the sign of the y -coordinate will change in a reflection across the x -axis.

Key Academic Terms:

coordinate plane, ordered pair, sign, axis, origin, integer, rational number, horizontal, vertical, negative, positive

Additional Resources:

- Activity: [Distance on the number line](#)
- Lesson: [Graphing integers on the coordinate grid](#)
- Activities: [Intro to the coordinate plane](#)

The Number System

Apply and extend previous understandings of numbers to the system of rational numbers.

10 Understand ordering and absolute value of rational numbers.

10a Interpret statements of inequality as statements about the relative position of two numbers on a number line diagram.

Example: Interpret $-3 > -7$ as a statement that -3 is located to the right of -7 on a number line oriented from left to right.

Guiding Question with Connections to Mathematical Practices:

How can the position of numbers on a number line be used to compare numbers?

M.P.2. Reason abstractly and quantitatively. Understand that numbers become greater when moving from left to right on a horizontal number line. For example, $-3 > -5$ because -3 is to the right of -5 on a number line, and $-2 < 0$ because -2 is to the left of 0 on a number line. Similarly, numbers become greater when moving up on a vertical number line. Additionally, recognize that a number, a , is located between two other numbers, b and c , if it is to the right of b and to the left of c , or to the right of c and to the left of b .

- Ask students to use the number line to determine a correct comparison between pairs of rational numbers. For example, given the pairs 2 and -2 , -4 and 6 , and -8 and $-7\frac{1}{2}$, students should be able to conclude that $2 > -2$, $-4 < 6$, and $-8 < -7\frac{1}{2}$.
- Ask students to determine and explain which number has a value between the other two when given three numbers and a number line. For example, given the integers -3 , 5 , and -7 , students should be able to determine that -3 is between -7 and 5 because it is to the right of -7 and to the left of 5 .

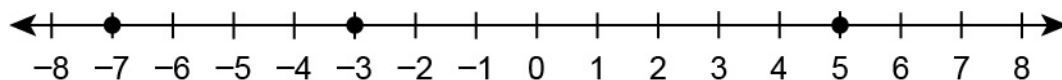

Key Academic Terms:

inequality, number line, greater than, less than

Additional Resources:

- Tutorial: [Graphing with number lines](#)
- Lesson: [Rational numbers on the number line—stations](#)
- Lesson: [Comparing rational numbers](#)

The Number System

Apply and extend previous understandings of numbers to the system of rational numbers.

10 Understand ordering and absolute value of rational numbers.

10b Write, interpret, and explain statements of order for rational numbers in real-world contexts.

Example: Write $-3^{\circ}\text{C} > -7^{\circ}\text{C}$ to express the fact that -3°C is warmer than -7°C .

Guiding Question with Connections to Mathematical Practices:

How can statements of order and inequalities be used to represent comparisons in real-world contexts?

M.P.4. Model with mathematics. Model the relationship between measurements, such as elevation or temperature, with ordered lists or inequalities. For example, the inequality $-3.5 > -5$ can be used to show that the temperature of -3.5°C on Monday was warmer (greater) than the temperature of -5°C on Tuesday because -3.5 is above -5 on a vertical number line. Additionally, use real-world information provided in tables to make comparisons.

- Ask students to create a context that could be represented by an inequality. For example, given the inequality $477 < 853$, a student might say that city A's elevation of 477 feet is less than city B's elevation of 853 feet.
- Ask students to answer questions of comparison given a table of measurements. For example, given the table shown, ask students to answer the following questions.

Daily Low Temperatures

Monday	-4°F
Tuesday	3°F
Wednesday	0°F
Thursday	-2°F
Friday	1°F

- Which day was coldest?
- Which day was warmest?
- Which day was colder than Friday, but warmer than Thursday?

Students should be able to conclude that Monday was coldest, Tuesday was warmest, and that the temperature on Wednesday was colder than Friday, but warmer than Thursday.

Key Academic Terms:

inequality, number line, greater than, less than, absolute value

Additional Resources:

- Lesson: [Absolute value and ordering rational numbers](#)
- Lesson: [Comparing rational numbers](#)

The Number System

Apply and extend previous understandings of numbers to the system of rational numbers.

10 Understand ordering and absolute value of rational numbers.

10c Understand the absolute value of a rational number as its distance from 0 on the number line; interpret absolute value as magnitude for a positive or negative quantity in a real-world situation.

Example: For an account balance of -30 dollars, write $|-30| = 30$ to describe the size of the debt in dollars.

Guiding Questions with Connections to Mathematical Practices:

How can a number line be used to understand absolute value?

M.P.2. Reason abstractly and quantitatively. Recognize that the absolute value of a number is its distance from zero on a number line. For example, the absolute value of -3 is 3 because -3 is 3 units away from zero. Additionally, understand that the absolute value of a number must always be nonnegative because distance cannot be negative.

- Ask students to determine the absolute value of different rational numbers by finding their distances from zero on a number line. For example, given the numbers -4 , $\frac{1}{2}$, and $-2\frac{1}{2}$, students should use the number line to determine that the numbers have absolute values of 4 , $\frac{1}{2}$, and $2\frac{1}{2}$.

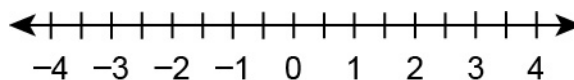

- Ask students to measure the distance from each tick mark to zero on a number line with tick marks spaced by units of length 1 centimeter. Be sure to emphasize that each negative number is a positive distance from zero.

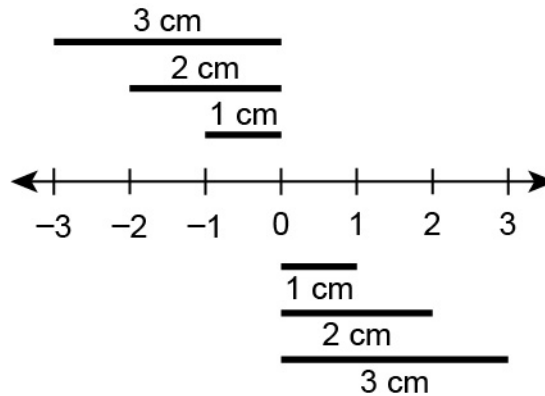

How is the absolute value of a number related to the absolute value of its opposite?

M.P.2. Reason abstractly and quantitatively. Understand that opposites have the same absolute value. For example, the absolute value of -5 is 5 and the absolute value of 5 is 5 because both are 5 units away from zero on a number line. Additionally, recognize that there are exactly two numbers that have any particular absolute value (with the exception of 0).

- Ask students to determine a different number that has the same absolute value as a given number. For example, if given the number $-3\frac{1}{3}$, students should be able to determine that $3\frac{1}{3}$ has the same absolute value because both numbers are the same distance from zero.
- Ask students to determine all numbers that have a given absolute value. For example, given the absolute value $\frac{11}{2}$, students should be able to determine that both $\frac{11}{2}$ and $-\frac{11}{2}$ have an absolute value of $\frac{11}{2}$.

- Ask students to explain why 0 is different from all other numbers when working with absolute value. Students should be able to articulate that 0 is its own opposite and therefore is the only number that is 0 units away from 0.

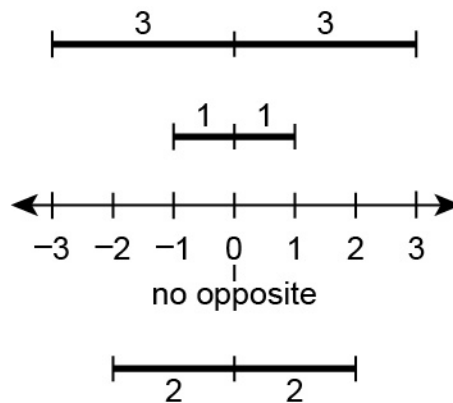

How does context impact the interpretation of an absolute value problem?

M.P.4. Model with mathematics. Interpret and solve a real-world problem using absolute value. For example, when given the problem “A whale has a recorded dive of $-9,874$ feet in relation to sea level. An airplane flies at $8,910$ feet in relation to sea level. Is the whale or the airplane farther from sea level?” identify that the whale is farther than the airplane from sea level, which is represented by 0, since the absolute value of $-9,874$ is greater than the absolute value of $8,910$. Also, a debt of 500 dollars, represented by $-\$500$, has a greater magnitude than a credit of 50 dollars, represented by $\$50$. Additionally, create visual representations of real-world contexts to solve absolute value problems.

- Ask students to create a context that a given number could represent. For example, given the number -17 , students might identify an account withdrawal of $\$17$ or a fish swimming 17 feet below the surface of the water.

- Ask students to draw an illustration and explain a given context. For example, utility workers bury a pipe 6 feet below ground and hang a wire that is 18 feet above ground. Students should be able to illustrate the depth of the pipe and the height of the wire in relation to the ground and connect that distance to absolute value.

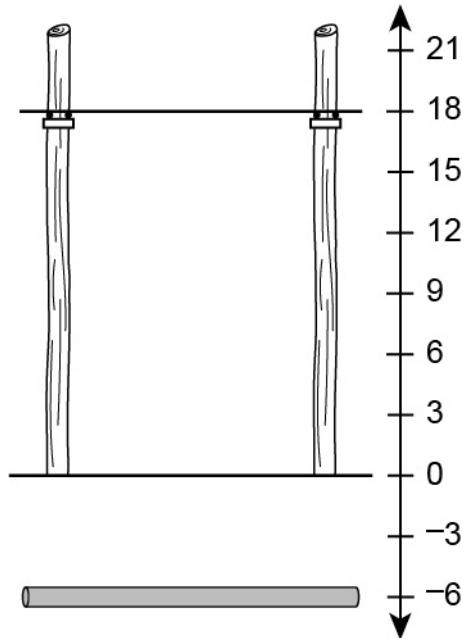

Key Academic Terms:

number line, absolute value, opposite, magnitude

Additional Resources:

- Activity: [Distance on the number line](#)
- Lesson: [Absolute value and ordering rational numbers](#)
- Tutorial: [Absolute value](#)

The Number System

Apply and extend previous understandings of numbers to the system of rational numbers.

10 Understand ordering and absolute value of rational numbers.

10d Distinguish comparisons of absolute value from statements about order.

Example: Recognize that an account balance less than -30 dollars represents a debt greater than 30 dollars.

Guiding Question with Connections to Mathematical Practices:

How is comparing the absolute values of two numbers different from comparing the order of the two numbers?

M.P.2. Reason abstractly and quantitatively. Compare the absolute values of two numbers based on each number's distance from 0, or magnitude, and compare the order of two numbers based on each number's position relative to each other, left or right, on a horizontal number line. For example, consider -10 and 5 . Since all negative numbers are less than all positive numbers, -10 is less than 5 and located to the left of 5 on a horizontal number line. However, $|-10|$ is greater than $|5|$ because -10 is farther away from 0. Additionally, recognize that the order of a set of negative numbers is the opposite of the order of their absolute values. Further, the order of a set of positive numbers is the same as the order of their absolute values.

- Ask students to order a set of numbers from least to greatest. Then, ask students to order the absolute values of the same set of numbers from least to greatest. For example, given the numbers $-10, 8, 6, -4, -2,$ and 1 , students should be able to order the numbers from least to greatest as $-10, -4, -2, 1, 6, 8$. Similarly, they should be able to order the absolute values of the numbers from least to greatest as $1, 2, 4, 6, 8, 10$.
- Provide students with a set of negative numbers that are ordered from least to greatest. Ask students to reorder the numbers according to absolute value, noting that the order is reversed. For example, given the numbers $-9, -7, -5, -3,$ and -1 , students should be able to reorder the absolute values of the numbers as $1, 3, 5, 7, 9$.

Key Academic Terms:

absolute value, magnitude, constant

Additional Resources:

- Tutorial: [What does absolute value mean in the real world?](#)
- Lesson: [Absolute value and ordering rational numbers](#)

The Number System

Apply and extend previous understandings of numbers to the system of rational numbers.

11 Solve real-world and mathematical problems by graphing points in all four quadrants of the coordinate plane. Include use of coordinates and absolute value to find distances between points with the same first coordinate or the same second coordinate.

Guiding Questions with Connections to Mathematical Practices:

How can a coordinate plane be used to solve real-world and mathematical problems?

M.P.5. Use appropriate tools strategically. Use a coordinate plane to solve a variety of problems. For example, a map of a park represents a basketball court as a rectangle on a coordinate plane. Three vertices of the rectangle are the points $(-5, 2)$, $(-5, -3)$, and $(2, -3)$. Plot the points and the sides of the rectangle on the coordinate plane to find the rectangle's remaining vertex, $(2, 2)$. Additionally, recognize that the coordinate plane can be used to solve perimeter and area problems involving two-dimensional geometric figures.

- Provide students with the coordinates of the two endpoints of a line segment. Then, ask students to determine and draw a line segment of the same length that contains a common endpoint with the original line segment. For example, given a line segment with endpoints at $(1, -3)$ and $(5, -3)$, draw a line segment with endpoints at $(1, -3)$ and $(1, 1)$, $(1, -3)$ and $(1, -7)$, $(1, -3)$ and $(-3, -3)$, $(5, -3)$ and $(5, 1)$, $(5, -3)$ and $(5, -7)$, or $(5, -3)$ and $(9, -3)$.

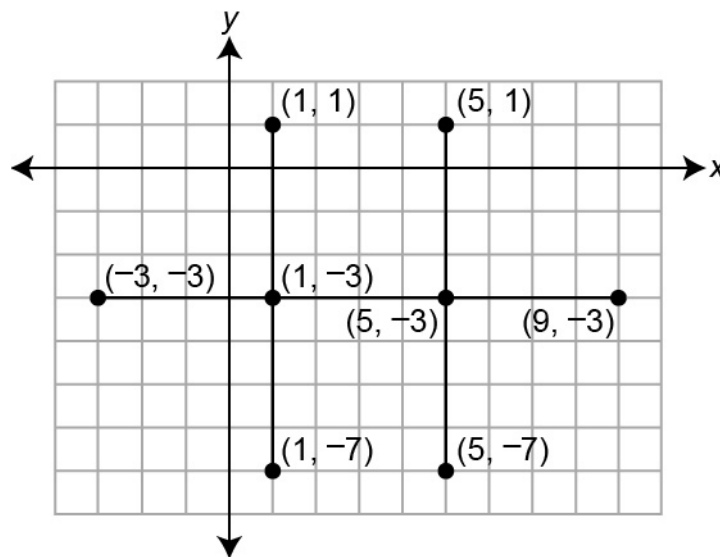

- Provide students with a coordinate plane and a set of coordinates that represents the vertices of a rectangle. Then, ask students to determine the perimeter and area of the rectangle. For example, given a rectangle with vertices at the coordinates $(0, 0)$, $(0, 2)$, $(3, 0)$, and $(3, 2)$, determine a perimeter of 10 units $(3 + 2 + 3 + 2)$ and an area of 6 square units (3×2) .

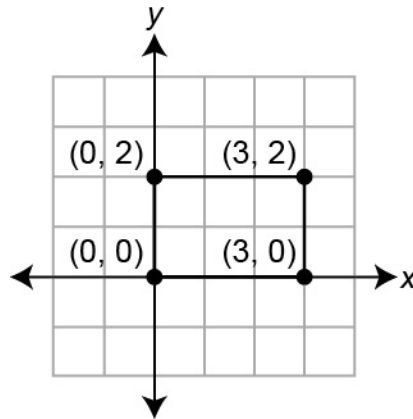

How does the absolute value of a coordinate help determine the distance between points on the coordinate plane?

M.P.4. Model with mathematics. Extend previous understanding of absolute value and magnitude to determine the distances between ordered pairs that contain negative coordinates. For example, recognize that the point $(1, -8)$ is a greater distance from the x -axis than the point $(1, 6)$ because the absolute value of -8 is greater than the absolute value of 6 . Additionally, the total distance between $(1, -8)$ and $(1, 6)$ is 14 units because the absolute value of -8 plus the absolute value of 6 is equivalent to the sum of 8 and 6. Further, given a length and the coordinates of one endpoint, determine the possible coordinates of the other endpoint of a line segment.

- Provide students with a coordinate plane and the coordinates of the endpoints of a line segment. Then, ask students to determine the length of the line segment. For example, given a line segment with endpoints at $(-1, 1)$ and $(-1, -3)$, determine the length is 4 units because the first endpoint is 1 unit above the x -axis and the second endpoint is 3 units below the x -axis. As such, the sum of 1 and 3 is 4.

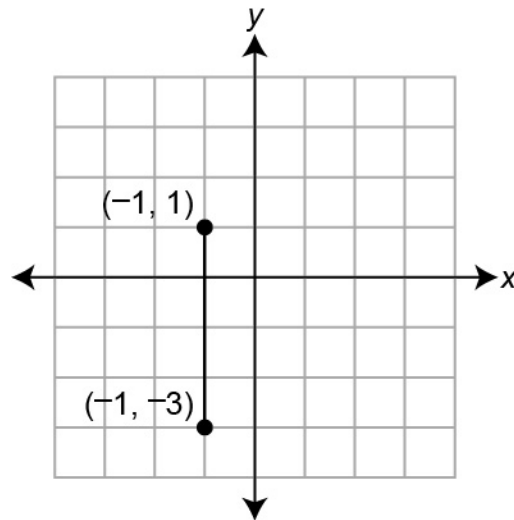

For an additional example, provide students with line segment endpoints at $(-2, -1)$ and $(-2, -5)$. Students should be able to determine that the length is 4 units because the first endpoint is 1 unit below the x -axis and the second endpoint is 5 units below the x -axis. As such, the line segment is 4 units long because the difference of 5 and 1 is 4.

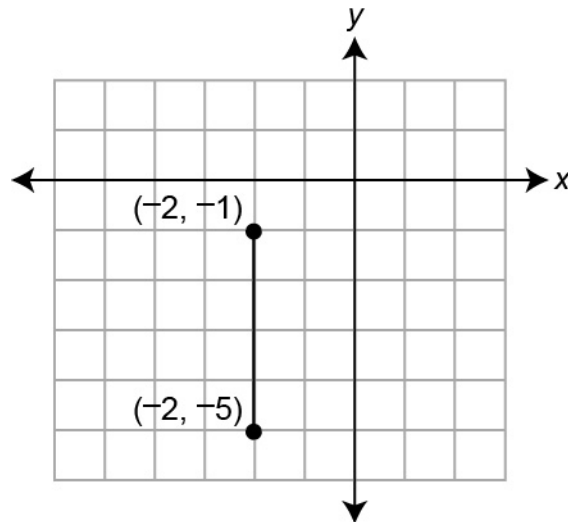

- Provide students with a coordinate plane and the coordinates of one endpoint of a line segment. Then, ask the students to determine the coordinates of the other endpoint given the quadrant location of the other endpoint and the segment length. For example, if students know that the coordinates of one endpoint of a line segment with length 6 is located at $(-2, -2)$ and the other endpoint is located in quadrant IV, then they should be able to determine that the unknown endpoint is at $(4, -2)$.

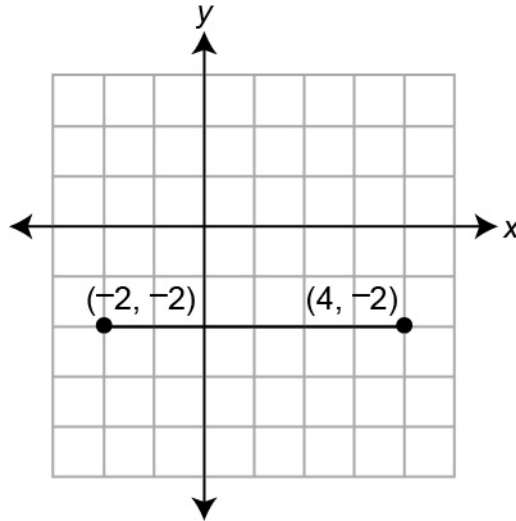

Key Academic Terms:

coordinates, coordinate plane, absolute value, magnitude, quadrant

Additional Resources:

- Video: [Coordinate plane | 4 quadrants](#)
- Lesson: [Distance between two points](#)

Expressions and Equations

Apply and extend previous understandings of arithmetic to algebraic expressions.

12 Write and evaluate numerical expressions involving whole-number exponents.**Guiding Question with Connections to Mathematical Practices:****How can equivalent expressions be used to help write, evaluate, and compare expressions with whole-number exponents?**

M.P.7. Look for and make use of structure. Express repeated multiplication by writing expressions using exponents. For example, when finding the volume of a cube with side lengths of 6 units, write the expression $6 \times 6 \times 6$ as 6^3 to represent the volume in cubic units. Additionally, compare expressions with whole-number exponents with like bases or like exponents.

- Ask students to express repeated multiplication of the same number by writing expressions using exponents. To write an equivalent expression using exponents, ask students to count the number of times a particular value is used as a factor. The number of times the value is used as a factor is equal to the exponent while the base is equal to the factor itself. For example, in the expression $5 \times 5 \times 5 \times 5$, the factor is 5, so 5 is the base. The number 5 appears as a factor 4 times, so 4 is the exponent. Therefore, the expression 5^4 is equivalent to $5 \times 5 \times 5 \times 5$.
- Ask students to rewrite an expression using exponents as repeated multiplication. In an expression using exponents, the base represents the factor and the exponent represents the number of times the factor appears. For example, the expression 8^3 is equivalent to an expression in which the factor of 8 is used 3 times, which can be represented as $8 \times 8 \times 8$.
- Ask students to compare expressions with whole-number exponents with like bases or like exponents. For example, students can compare 4^5 and 3^5 by noting that the exponents are equal and the base of 4^5 is greater than the base of 3^5 , so $4^5 > 3^5$. Likewise, students can compare 4^6 and 4^8 by noting that the bases are equal and the exponent of 4^6 is less than the exponent of 4^8 , so $4^6 < 4^8$.

M.P.7. Look for and make use of structure. Represent expressions with whole-number exponents by applying the properties of operations and order of operations to create equivalent expressions. For example, evaluate $4^3 - 3(2 + 4^2) + 8$ by using the order of operations and the distributive property to find the solution 18. Additionally, understand the effect that parentheses can have on the value of an expression.

- Ask students to find the value of an expression by applying order of operations. For example, give students the expression shown.

$$6^2 + 2(4 + 5^2) - 3(6 + 4)$$

Students should start by evaluating the parts of the expression inside the parentheses using order of operations. The part of the expression in the first set of parentheses is equivalent to $4 + 25$, and also 29, while the part of the expression in the second set of parentheses is equivalent to 10. The expression can now be written as shown.

$$6^2 + 2(29) - 3(10)$$

The power 6^2 can be simplified to 36, while $2(29) = 58$ and $3(10) = 30$, so the expression is equivalent to $36 + 58 - 30$, which is equal to 64.

- Ask students to evaluate an expression multiple times by adjusting the location of parentheses. For example, given the expression shown, have students place parentheses around different values and operations.

$$6 \times 8^2 + 3 \times 2^3$$

- Without parentheses, the value of the expression is $384 + 24 = 408$.
 - Parentheses around $8^2 + 3$ change the value to 3,216.
 - Parentheses around $6 \times 8^2 + 3$ change the value to 3,096.
 - Parentheses around $8^2 + 3 \times 2^3$ change the value to 528.
- Ask students to discuss what placements of parentheses would have no change on the value of the expression and why. In the example above, putting 6×8^2 or 3×2^3 in parentheses has no change because those parts of the expression would be evaluated first due to order of operations even without the parentheses.

Key Academic Terms:

exponent, base, order of operations

Additional Resources:

- Lesson: [Introducing exponents](#)
- Lesson: [The use of exponents](#)
- Lesson: [The power of exponents](#)

Expressions and Equations

Apply and extend previous understandings of arithmetic to algebraic expressions.

13 Write, read, and evaluate expressions in which letters stand for numbers.

13a Write expressions that record operations with numbers and with letters standing for numbers.

Example: Express the calculation, “Subtract y from 5,” as $5 - y$.

Guiding Questions with Connections to Mathematical Practices:**What does a variable represent in an expression?**

M.P.6. Attend to precision. Recognize that in an expression, a variable represents a quantity that can change. For example, if there are 5 groups of students in a classroom, and each group has n students, the expression $5n$ represents the total number of students in the classroom. Additionally, understand that the values a variable can represent may be limited based on the quantity represented by the variable.

- Ask students to discuss whether a given real-world quantity would be reasonable to represent with a variable or not based on whether or not it could change. For example, representing the number of states in the United States is not a logical quantity for which to use a variable since the number of states is unlikely to change. However, representing the number of people living in a city is a logical quantity for which to use a variable since it is a quantity that is likely to change frequently.
- Ask students to determine values a variable could and could not represent given an expression with a variable in it. For example, if the expression $8t$ is used to represent the total cost of t tickets to a movie, the value of t is restricted to nonnegative whole numbers because it is not possible to sell a negative number of movie tickets nor to sell partial tickets. However, if the expression $32g$ represents the number of miles traveled in a car that used g gallons of gas, the value of g is restricted to nonnegative rational numbers, since a car can use a fractional amount of a gallon of gas.

How can situations be represented with expressions using variables?

M.P.4. Model with mathematics. Represent real-world and mathematical situations with an expression that contains variables. For example, given that 1 hat costs \$26, 2 hats cost \$52, 3 hats cost \$78, and the same pattern continues, write the expression $26h$ to indicate the total cost (in dollars) of h hats. Additionally, understand that the possible values of the variables can be affected by the context and also by the form of the expression.

- Ask students to model real-world situations with an expression that contains a variable. Students should explore expressions with all 4 operations. Possible real-world situations that can be represented include:
 - the number of textbooks that a school with 20 textbooks will have after ordering b additional books (addition)
 - the number of members a museum has after m of its 520 memberships expire (subtraction)
 - the total fine for a library book that is d days overdue with a fixed fine of \$0.15 per day (multiplication)
 - the number of containers needed to hold 1,200 beads given that there are b beads in each container (division)

The corresponding expressions could be:

- $20 + b$
 - $520 - m$
 - $0.15d$
 - $1,200 \div b$ (or $\frac{1200}{b}$)
- Ask students to discuss possible values of a variable in an expression that represents a real-world situation. In the previous examples, the variable must have a nonnegative whole number value for each of the first three situations because textbooks, memberships, and days overdue are all nonnegative and must all be whole numbers. However, in the fourth situation and expression, the variable must be a positive whole number. It does not make sense to talk about part of a container, and it also does not make sense to talk about placing beads in 0 containers. The form of the expression precludes b from being equal to 0 because a quantity is being divided by b and division by 0 is undefined.

Key Academic Terms:

expression, variable, operation

Additional Resources:

- Lesson: [Variables: exploring expressions and equations](#)
- Activity: [Variable matching game](#)
- Video: [Real-life math | Astrobiologist](#)

Expressions and Equations

Apply and extend previous understandings of arithmetic to algebraic expressions.

13 Write, read, and evaluate expressions in which letters stand for numbers.

13b Identify parts of an expression using mathematical terms (*sum, term, product, factor, quotient, coefficient*); view one or more parts of an expression as a single entity.

Example: Describe the expression $2(8 + 7)$ as a product of two factors; view $(8 + 7)$ as both a single entity and a sum of two terms.

Guiding Questions with Connections to Mathematical Practices:

How are parts of expressions defined with mathematical terminology?

M.P.7. Look for and make use of structure. Represent parts of an expression using mathematical terminology for various operations. For example, in the expression $8(4 + p) \div 2$, 8 and $(4 + p)$ are factors of the product $8(4 + p)$, $(4 + p)$ is a single entity that is the sum of two terms, and the entire expression is a quotient with a dividend of $8(4 + p)$ and a divisor of 2. Additionally, recognize that a single quantity can be defined in multiple ways.

- Ask students to describe a whole expression and parts of the expression verbally using mathematical terminology. For example, given the expression $(2 \div x) + (4 - x)$, a valid description is “The sum of the quotient of 2 and x and the difference of 4 and x .” Students might also describe the first term as a quotient with a dividend of 2 and a divisor of x .
- Ask students to list multiple mathematical words for a single quantity in an expression. For example, given the expression $y \div (2 + x)$, describe $(2 + x)$ as both a sum and a divisor. If the expression were changed to $y \div 3[(2 + x)]$, students could describe $(2 + x)$ as a factor of $3(2 + x)$ as well as a sum.
- Ask students to write expressions that match given mathematical terminology. For example, given “a product with 2 factors, one of which is the sum of two numbers and the other of which is a variable,” write $(3 + 5)(x)$. Likewise, given “a quotient of a sum and a product, where the product has two factors, one of which is a variable,” write $(2 + 5) \div x(3 + 6)$.

What distinguishes a term in an expression from the expression itself?

M.P.6. Attend to precision. Recognize that terms are parts of an expression that are either added together or subtracted from each other. For example, the expression $3a + 2b$ contains two terms, $3a$ and $2b$, because they are added together. Additionally, recognize that not all addition or subtraction in an expression necessarily denotes a term.

- Ask students to identify the terms in a given expression. For example, given the expression $5p + (-12q) - 6$, identify the three terms of the expression as $5p$, $-12q$, and 6 . Note the operator connecting the terms is not included as part of the term and that each of these terms is also an expression by itself. Further, recognize that the way an expression is written will affect what its terms are. Because $5p + (-12q) - 6$, when written with addition instead of subtraction, is equivalent to $5p + (-12q) + (-6)$, many consider the terms of both expressions to be $5p$, $-12q$, and -6 .
- Ask students to create as many different expressions as possible from a few given terms. For example, give students the terms $-5m$ and $9n$. Without reusing terms, the expressions that can be created are: $-5m$, $9n$, $-5m + 9n$, $-5m - 9n$, $9n + (-5m)$, and $9n - (-5m)$.
- Ask students to recognize that not all addition or subtraction necessarily indicates a term. For example, $2x$ and $3y$ are not terms of the expression $8 + 5(2x + 3y)$. The two terms of the expression are 8 and $5(2x + 3y)$.

What distinguishes a coefficient from a constant in an algebraic expression?

M.P.6. Attend to precision. Recognize that a coefficient is a number multiplied by a variable, while a constant is a quantity that does not change. For example, in the expression $4c + 1$, 4 is a coefficient and 1 is a constant. Additionally, recognize that when a variable appears in an expression without a written coefficient, the coefficient is 1 .

- Ask students to classify numbers in an algebraic expression as either coefficients or constant terms. For example, given the expression $3x + 2y + 8$, classify 3 and 2 as coefficients and 8 as a constant term. Also, given an expression that contains a variable without a written coefficient, recognize that the coefficient is 1 . For example, given the expression $x - 5y + 3$, classify 1 and -5 as coefficients and 3 as a constant term.

- Ask students to write algebraic expressions that contain a given list of coefficients or constant terms. For example, given coefficients of 1, 2, and 3 and a constant term of 6, students could write expressions such as the expressions given.
 - $x + 2y + 3z + 6$
 - $2x + 3x + z + 6$
 - $x + 2x + 6 + 3x$

How can a context help create meaning for an algebraic expression?

M.P.2. Reason abstractly and quantitatively. Interpret an expression and a context to give meaning to the different parts of the expression. For example, given that Rebecca picks a total of $3h$ pints of blueberries for a period of h hours, interpret the 3 as the number of pints of blueberries Rebecca picks each hour, h . Additionally, understand that the context can impose limits on the reasonable values possible for the variable.

- Given an expression and a context relating to the expression, ask students to identify what each part of the expression represents in terms of the context. For example, given that a bicycle rental costs \$10 plus an additional \$4 per hour, along with the expression $10 + 4h$, identify that 10 represents the initial charge, 4 represents the hourly charge, and h represents the total number of hours for which the bicycle is rented. Also, identify that the entire expression represents the total cost to rent a bicycle for h hours.
- Ask students to describe limits on the possible values of a variable based on the context of the algebraic expression in which the variable appears. For example, given that museum tickets are sold for \$18, along with the expression $18t$ to represent the total amount of money made from ticket sales, identify that t must be a nonnegative whole number since it is impossible to sell a fractional amount of a ticket. As an additional example, given that Maria raises \$8.75 per mile she walks during a charity event, along with the expression $8.75m$ to represent the total amount of money Maria raises for charity, identify that m cannot be a negative number. Also, discuss whether it makes sense for m to be 0. Some discussion questions follow.
 - Is it possible that Maria does not participate in the event?
 - Does it make sense for m to be a positive fraction, such as 1.25?
 - Is it possible that Maria only raises money for each complete mile?

Key Academic Terms:

expression, algebraic expression, variable, operation, term, coefficient, constant, sum, product, quotient, factor, distributive property

Additional Resources:

- Lesson: [Variables: exploring expressions and equations](#)
- Lesson: [Evaluating expressions](#)

Expressions and Equations

Apply and extend previous understandings of arithmetic to algebraic expressions.

13 Write, read, and evaluate expressions in which letters stand for numbers.

13c Evaluate expressions at specific values of their variables. Include expressions that arise from formulas used in real-world problems. Perform arithmetic operations, including those involving whole-number exponents, in the conventional order when there are no parentheses to specify a particular order (Order of Operations).

Example: Use the formulas $V = s^3$ and $A = 6s^2$ to find the volume and surface area of a cube with sides of length $s = \frac{1}{2}$.

Guiding Questions with Connections to Mathematical Practices:**How are variables related to mathematical formulas?**

M.P.4. Model with mathematics. Use a formula to represent the relationship between quantities that can change (variables) in an expression or equation and know that variables represent specific attributes. For example, the formula $A = l \times w$ shows the relationship between the area, A , of a rectangle and the product of the rectangle's length, l , and width, w . Additionally, understand that formulas can be written in different ways to illustrate different methods of calculating specific attributes.

- Ask students to examine formulas and determine what each variable represents. For example, given the formula $V = l \times w \times h$, determine the following:
 - V represents the volume of a rectangular prism,
 - l represents the length of the base of the prism,
 - w represents the width of the base of the prism, and
 - h represents the height of the prism.

Likewise, given the formula $V = s^3$, determine that V represents the volume of a cube with a side length of s .

- Ask students to determine different formulas that each represent a way to calculate a specific attribute. For example, given a rectangle with side lengths of x and y units, students could choose to add all 4 side lengths together to determine the perimeter, P . A formula to represent this is $P = x + x + y + y$. Alternatively, students could choose to take each of the different side lengths and double them and then find the sum. A formula to represent this is $P = 2x + 2y$. Finally, students could choose to find the semi-perimeter and double it. A formula to represent this is $P = 2(x + y)$.

How can an expression be evaluated for specific values of the variables?

M.P.1. Make sense of problems and persevere in solving them. Use properties of operations and order of operations to evaluate an expression for specific values of the variables. For example, to evaluate $3(2 + z) - 6 \div 2$ where $z = 4$, decide whether to distribute the 3 in $3(2 + z)$ or to substitute the 4 for z and add within the grouping symbols first, using the order of operations. Then, continue solving using properties of operations and order of operations for a solution of 15. Additionally, recognize that the choice of when to make an indicated substitution does not change the value of the expression.

- Ask students to evaluate expressions for specific values of variables. For example, to evaluate $6 + y \times 3$ where $y = 5$, students should make the substitution for y first and rewrite the expression as $6 + 5 \times 3$. Then, follow the order of operations by first multiplying 5×3 to get 15, and then adding $6 + 15$ to get 21. Students should also evaluate expressions with more than 1 variable. For example, to evaluate $p + 4 \times q - 1$ where $p = 3$ and $q = 7$, make the substitutions for both p and q first and write the expression as $3 + 4 \times 7 - 1$. Then, follow the order of operations by first multiplying 4×7 to get 28, and then simplifying $3 + 28 - 1$ to get 30.

- Ask students to evaluate expressions for specific values of variables in which the order of operations can change based on when the substitution is made. For example, to evaluate $5(p + 2) - 4$ where $p = 9$, students could choose to substitute 9 for p immediately or make the substitution after simplifying the expression.
 - If students choose to substitute $p = 9$ immediately, the result is the expression $5(9 + 2) - 4$. In this case, based on order of operations, add $9 + 2$ together to get 11, then multiply that by 5 to get 55, and finally subtract 4 to get 51.
 - If students choose to wait before substituting, then the addition inside the parentheses cannot be performed. In this case, the 5 should be distributed, resulting in an expression of $5p + 10 - 4$, which simplifies to $5p + 6$. Now, when $p = 9$ is substituted, the result is $45 + 6$, which equals 51.

Students can discuss which method is preferable and whether the preferred method might change based on the expression. Remind students that in the latter method, substituting the value of 9 for the variable p makes the expression $5 \times 9 + 6$, not $59 + 6$.

Why is the conventional order of operations significant when using formulas?

M.P.4. Model with mathematics. Recognize that formulas are constructed by assuming the conventional order of operations. For example, the formula for the surface area of a cube with side length s , $A = 6s^2$, only works when the exponent is evaluated prior to multiplying by 6. If $s = 2$ inches, then the surface area equals 24 square inches rather than 144 square inches. Additionally, recognize that the order of operations used when evaluating a formula depends on when values are substituted into the formula.

- Ask students to evaluate formulas for given values of the variables using order of operations. For example, ask students to evaluate the formula $V = s^2h$ to find the volume of a prism with height h and a square base with side lengths s given different values for h and s . Regardless of the values for h and s , first multiply the value of s by s , and then multiply that product by h .
 - When $h = 8$ inches and $s = 3$ inches, the volume is $3^2 \times 8 = 9 \times 8 = 72$ cubic inches.
 - When $h = 10$ inches and $s = 5$ inches, the volume is $5^2 \times 10 = 25 \times 10 = 250$ cubic inches.

- Ask students to evaluate formulas for given values of the variables in different ways by substituting the given values into the formula at different points. For example, the formula $P = 2(l + w)$ can be used to find the perimeter of a rectangle with a length of l units and a width of w units. Given a rectangle with $l = 4$ inches and $w = 3$ inches, make the substitution for l and w at the beginning of the simplification process or at the end.
 - If students choose to make both substitutions immediately, the perimeter can be expressed as $2(4 + 3) = 2(7) = 14$ inches.
 - If students choose to make both substitutions after the expression is simplified, students can distribute the 2 in the formula, resulting in $P = 2l + 2w$. Now, substituting the appropriate values yields a solution of $2l + 2w = 2(4) + 2(3) = 8 + 6 = 14$ inches.

Key Academic Terms:

variable, formula, order of operations, expression, parentheses, exponent

Additional Resources:

- Video: [Order of operations](#)
- Lesson: [Evaluating expressions](#)

Expressions and Equations

Apply and extend previous understandings of arithmetic to algebraic expressions.

14 Apply the properties of operations to generate equivalent expressions.

Example: Apply the distributive property to the expression $3(2 + x)$ to produce the equivalent expression $6 + 3x$; apply the distributive property to the expression $24x + 18y$ to produce the equivalent expression $6(4x + 3y)$; apply properties of operations to $y + y + y$ to produce the equivalent expression $3y$.

Guiding Questions with Connections to Mathematical Practices:

How can different symbols representing multiplication and division be used to generate equivalent expressions?

M.P.6. Attend to precision. Recognize and use parentheses, a juxtaposition, or a dot to represent multiplication and a division or fraction bar to represent division. For example, recognize that 3 times c can be expressed as $3(c) = 3c = 3 \cdot c$ and that 4 divided by y can be expressed as $4 \div y = \frac{4}{y} = 4 \cdot \frac{1}{y} = 4\left(\frac{1}{y}\right)$. Additionally, recognize that the choice of how to represent a product or a quotient can depend on the expression as a whole.

- Ask students to write expressions involving multiplication in different ways, with each way using a different representation of multiplication. For example, given the expression $18y$, write $18(y)$, $(18)y$, and $18 \cdot y$.
- Ask students to write expressions involving division in different ways, with each way using a different representation of division. For example, given the expression $y \div 10$, write $\frac{y}{10}$, $y \cdot \frac{1}{10}$, and $y\left(\frac{1}{10}\right)$, among others.
- Ask students to recognize that the simplification required in an expression can dictate which representation of multiplication or division is the most logical. For example, given the expression $6\left(\frac{x}{5}\right) + (x \div 3)$, it is most logical to express $(x \div 3)$ as $\frac{x}{3}$ so it can be added to $\frac{6x}{5}$, an equivalent version of the first term.

How are expressions with variables composed and decomposed?

M.P.7. Look for and make use of structure. Use the properties of operations to compose and decompose expressions with variables. For example, decompose $12x$ in a variety of ways, such as $x + x + x + x + x + x + x + x + x + x + x + x$, $2 \cdot 6x$, $3(4x)$, $6x + 6x$, and $x(10 + 2)$. Additionally, decompose expressions with variables by factoring and choose from multiple possible factors where appropriate.

- Ask students to write expressions in a variety of ways using a variety of operations. For example, given the expression $8y$, decompose it in the following ways, among others:
 - use addition to decompose it as $y + y + y + y + y + y + y + y$,
 - use addition to decompose it as $6y + 2y$,
 - use multiplication to decompose it as $2(4y)$, or
 - use multiplication and addition to decompose it as $(7 + 1)y$.

Students should write a given expression decomposed in 2 or 3 ways and then compare these equivalent expressions to the expressions written by other students.

- Ask students to factor expressions containing sums involving variables by factoring out a common factor of the coefficients. For example, given the expression $12x + 6$, decompose it as $2(6x + 3)$, $3(4x + 2)$, or $6(2x + 1)$. Ask students to write equivalent expressions for a given expression and compare these expressions to the expressions written by other students.

M.P.6. Attend to precision. Identify conventions when using variables, such as hidden coefficients of one, combining like terms, and the various multiplication representations. For example, identify the expression $7p - p$ as $7p - 1p$ to create the equivalent expression $6p$. Additionally, recognize when conventions are useful for clarifying the processes used while creating equivalent expressions.

- Ask students to create expressions equivalent to given expressions with hidden coefficients. For example, students could write the expression $8y + y$ as the equivalent expression $8y + 1y$ and then add the coefficients of like terms to generate the equivalent expression $9y$. Likewise, students could write the expression $12p - p$ as the equivalent expression $12p - 1p$ and then subtract the coefficients of like terms to generate the equivalent expression $11p$. Students should understand that rewriting terms like y and p as $1y$ and $1p$, respectively, is not necessary but may make the process of combining like terms clearer.

- Ask students to use a variety of multiplication and division representations to help create equivalent expressions. For example, students could write the expression $(y \div 5) + \left(\frac{3y}{5}\right)$ as the equivalent expression $\frac{y}{5} + \frac{3y}{5}$ to facilitate adding the fractions to generate the equivalent expression $\frac{4y}{5}$. Likewise, students could write $\frac{3q}{7} + 6$ as $3 \cdot \frac{q}{7} + 6$ to facilitate factoring out the common factor of 3 to generate the equivalent expression $3\left(\frac{q}{7} + 2\right)$. Students should understand that rewriting multiplication and division expressions using these conventions is not necessary but may make the simplification process clearer.

Key Academic Terms:

expression, equivalent, variable, like terms, properties of operations

Additional Resources:

- Lesson: [Equivalent expressions using mathematical properties](#)
- Activity: [Anna in D.C.](#)

Expressions and Equations

Apply and extend previous understandings of arithmetic to algebraic expressions.

15 Identify when two expressions are equivalent (i.e., when the two expressions name the same number regardless of which value is substituted into them).

Example: The expressions $y + y + y$ and $3y$ are equivalent because they name the same number regardless of which number y represents.

Guiding Question with Connections to Mathematical Practices:

How can the equivalency of two algebraic expressions be verified without substituting a value into the variables?

M.P.2. Reason abstractly and quantitatively. Apply any of the properties of operations to one expression so that it generates a second expression. For example, the expression $2(5k + 1)$ is equivalent to the expression $10k + 2$ because $2(5k + 1)$ becomes $10k + 2$ when the distributive property is applied. Additionally, recognize that some algebraic expressions may have many different equivalent forms.

- Ask students to write an equivalent expression to a given algebraic expression. For example, given the expression $3x + 2x$, add like terms to get the equivalent expression $5x$. Similarly, given the expression $4(3y + 5)$, apply the distributive property to get the equivalent expression $12y + 20$, as shown by the area model.

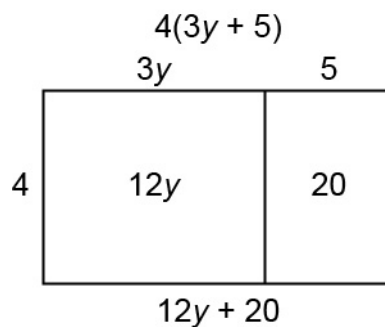

- Ask students to write multiple equivalent expressions to a given algebraic expression, with each equivalent expression following the application of a single property. For example, given the expression $3(2z + 4) + 4(z - 8)$, apply the distributive property. If the distributive property is applied in two separate steps, students can obtain additional equivalent expressions, such as $6z + 12 + 4(z - 8)$. If the distributive property is applied in one step, students can obtain the equivalent expression $6z + 12 + 4z - 8$. Then, like terms can be combined to result in the expression $10z + 4$. Again, if like terms are combined in separate steps, obtain additional equivalent expressions, such as $10z + 12 - 8$.
- Ask students to determine whether two algebraic expressions are equivalent by creating a sequence of equivalent expressions connecting them. For example, ask students to determine whether the expressions $3(2x + 7) - 13$ and $2(3x + 4)$ are equivalent.

- The first expression is equivalent to $6x + 8$.

$$\begin{aligned} 3(2x + 7) - 13 \\ &= 6x + 21 - 13 && \text{because of the distributive property} \\ &= 6x + 8 && \text{by combining like terms} \end{aligned}$$

- The second expression is also equivalent to $6x + 8$.

$$\begin{aligned} 2(3x + 4) \\ &= 6x + 8 && \text{because of the distributive property} \end{aligned}$$

Because there is a chain of equivalent expressions linking the two expressions, the two expressions themselves are equivalent. Point out to students that not being able to find such a chain of equivalent expressions would NOT prove that the expressions are not equivalent. Non-equivalency can be proven by substituting values into the expressions and finding a counterexample.

Key Academic Terms:

equivalent expressions, properties of operations, variable

Additional Resources:

- Lesson: [Equivalent expressions using mathematical properties](#)
- Activity: [Equivalent Expressions](#)

Expressions and Equations

Reason about and solve one-variable equations and inequalities.

16 Understand solving an equation or inequality as a process of answering a question: which values from a specified set, if any, make the equation or inequality true? Use substitution to determine whether a given number in a specified set makes an equation or inequality true.

Guiding Question with Connections to Mathematical Practices:**What does it mean to solve an equation or inequality?**

M.P.6. Attend to precision. Define solving an equation or inequality as the process of reasoning, using substitution or the structure of a problem, to find the numbers that make that equation or inequality true. For example, 6 is the solution to the equation $w + 4 = 10$ because the equation is true when w is 6; and in the inequality $3z < 24$, the solution is $z < 8$ because the inequality is true with any number less than 8. Additionally, understand that a value can be substituted for a variable to determine whether that value is a solution to the equation or is in the solution set of the inequality. For example, $y = 2$ is a solution to $4y = 8$ because $4(2) = 8$ is a true statement.

- Ask students to determine the solution to an equation or the solution set to an inequality by answering the question “What value or values will make this true?” For example, give students the inequality $-3 + r > 5$. Explain that solving the inequality means determining what values will make it true. Determine that the inequality shows adding -3 to an unknown value r and that the sum must be greater than 5. The value of r that makes the two sides of the inequality equivalent is 8 because $-3 + 8$ is equal to 5. Therefore, any value that is greater than 8 would be a solution to the inequality. This is represented by $r > 8$.
- Ask students to determine whether a given solution is correct by substituting the value or values into the equation or inequality to determine whether it generates a true statement. For example, give students the equation $-3v = 24$. Ask students to determine whether the solution $v = -8$ is correct. Show that when -8 is substituted for v , the equation generated is $-3(-8) = 24$, which is equivalent to the true equation $24 = 24$. As an additional example, give students the inequality $q - 6 < 9$. Ask students to determine whether the solution set $q < 3$ is correct. Show that although every value in the solution set $q < 3$ is true, it does not include ALL of the possible correct answers. Since 15, not 3, minus 6 is equal to 9, the correct endpoint of the solution set to the inequality should be 15. Therefore, the correct solution set to the inequality is $q < 15$.

Key Academic Terms:

equation, inequality, solution, substitution, subtraction property, addition property, distributive property

Additional Resources:

- Game: [Math balloons algebra game](#)
- Tutorial: [How do you determine if a value is a solution to an inequality?](#)

Expressions and Equations

Reason about and solve one-variable equations and inequalities.

17 Use variables to represent numbers, and write expressions when solving a real-world or mathematical problem; understand that a variable can represent an unknown number or, depending on the purpose at hand, any number in a specified set.

Guiding Questions with Connections to Mathematical Practices:**What is a variable and how can it be used to solve problems?**

M.P.2. Reason abstractly and quantitatively. Recognize that a variable is a letter or symbol representing a number and that an expression containing a variable or variables can be used to solve problems. For example, if Elizabeth practices the violin for 25 minutes every day, then the variable d could be used to represent the number of days Elizabeth practiced the violin and the expression $25d$ would represent the number of minutes Elizabeth practiced over any number of days. To determine how many minutes Elizabeth would practice the violin in a week, the expression $25d$ can be changed to $25(7)$, which is equivalent to 175 minutes for the week. Additionally, understand that when an expression contains a coefficient with a variable, such as $5p$, the coefficient is being multiplied by the variable. Further, while the multiplication between a variable and coefficient is understood and no symbol is used, when a value is substituted for the variable, the multiplication must be explicitly shown using parentheses, the symbol \times , or the symbol \bullet to represent the operation.

- Ask students to write an expression to represent a real-world problem using variables to represent unknown numbers. For example, “Henry has \$165 in his savings account and spends \$10 each week.” To write an expression to represent the value of Henry’s account after w weeks, determine that 165 is being decreased by 10 each week and the number of weeks is the unknown number. Use deductive reasoning to determine that the number of weeks can be multiplied by 10 and then subtracted from the initial amount, and therefore the expression $165 - 10w$ can be used to represent the value of Henry’s account after w weeks.

- Ask students to evaluate an expression that represents a real-world situation by substituting a specific value for the variable and generating an equivalent value for the resulting expression. For example, give students the situation “Julie has already read 140 pages of a book and plans to read 24 more pages each day. The expression $140 + 24d$ can be used to represent the total number of pages Julie will have read after d days.” To determine the total number of pages Julie will have read after 8 days, substitute 8 for the variable in the expression to create the expression $140 + 24(8)$. To evaluate the expression, first multiply 24 by 8, then add the product to 140.

$$140 + 24(8)$$

$$140 + 192$$

$$332$$

Using the expression, conclude that after 8 days, Julie will have read 332 pages.

M.P.7. Look for and make use of structure. Recognize that when the same variable is used more than once within an expression or equation, the value of the variable is the same in each instance. For example, each x in the equation $2x + 4 = 3(x - 2)$ has the same value. Additionally, understand that when a variable is used more than once within an expression, the terms containing the variable can be expressed as a single term. For example, the expression $4x + 2x + 5$ can be expressed as $6x + 5$.

- Ask students to evaluate an expression containing multiple terms with the same variable by substituting the same value for the variable in every instance of the variable. For example, in the expression $-4x + 6(x - 3)$, determine the value of the expression when $x = -2$. First, substitute -2 into the expression for the variable to create the expression $-4(-2) + 6[(-2) - 3]$. Then, following the order of operations, evaluate the expression to find that it is equivalent to -38 .

$$4(-2) + 6[(-2) - 3]$$

$$4(-2) + 6(-5)$$

$$-8 + (-30)$$

$$-38$$

- Ask students to write an expression that contains multiple terms with the same variable. For example, give students the situation “Nolan is earning money over the summer by mowing lawns. He is going to save 20% of the amount of money he earns and spend the rest.” To write an expression that represents the amount of money Nolan can spend based on the amount of money he earns, determine that the amount of money Nolan earns in total is m dollars. Since Nolan is saving 20% of that unknown value, the term “ $0.2m$ ” can be used to represent the amount of money Nolan saves. Therefore, the expression $m - 0.2m$ can be used to represent the amount of money Nolan can spend because the total amount of his earnings that he can spend is being reduced by the amount he saves. Since $1 - 0.2 = 0.8$, the expression $0.8m$ can be used to find the amount of money Nolan spends.
- Ask students to generate an equivalent expression for a given expression that contains multiple terms with the same variable. For example, give students the expression $5z - 3z + 7$. Determine that an equivalent expression can be generated that will have one term containing z since the first term and second term both contain the variable z . Explain that if $3z$ is subtracted from $5z$, $2z$ is the result, so the expression $2z + 7$ is equivalent to the given expression. Additionally, give students the expression $6y + 3 + 4y$. Determine that an equivalent expression can be generated that will have one term containing y because the first term and third term both contain the variable y . Combining the y terms yields $6y + 4y = 10y$, so the given expression is equivalent to $10y + 3$.

How can the meaning of the variable be determined for a given problem?

M.P.6. Attend to precision. Understand that a variable can be a single value, or all the values in a solution set, and that the solution set may be limited by a context. For example, when given the expression $0.89b$ to calculate the cost of bananas for b pounds of bananas, know the solution set is all values greater than or equal to 0, as it is not reasonable to have negative pounds of bananas. Additionally, understand that when the possible values of the variable are limited by the context of the situation an expression represents, the solutions will be similarly limited. For example, when given the expression $26p$ to represent the cost of p people gaining entrance into an amusement park, the only values of p that have meaning in context are whole numbers, so the solutions must only include 0 and multiples of 26.

- Ask students to determine and describe the set of meaningful values for the variable when given an expression that represents a given context. For example, give students the situation “A tree that is 4 feet tall grows at a rate of 6 inches per year. The expression $4 + \frac{1}{2}y$ can be used to determine the height of the tree after y years” and explain that only values greater than or equal to 0 have meaning in this context because the number of years cannot be represented by negative numbers. Then, students should determine the meaningful values of y .
- Ask students to describe and use the set of meaningful values of an expression that represents a given context. For example, give students the situation “The cost per person to attend a concert is \$14.” Determine that the expression $14p$ can be used to determine the cost, in dollars, for p people to attend the concert. The meaningful values of the variable are whole numbers, since the number of people can only be measured in whole numbers. Therefore, the meaningful values of the expression are 0 and all multiples of 14.

Key Academic Terms:

variable, expression, equation, solution set, subtraction property, addition property, distributive property

Additional Resources:

- Tutorial: [How do you write an equation from a word problem?](#)
- Activity: [Firefighter allocation](#)

Expressions and Equations

Reason about and solve one-variable equations and inequalities.

18 Solve real-world and mathematical problems by writing and solving equations of the form $x + p = q$ and $px = q$ for cases in which p , q , and x are all nonnegative rational numbers.

Guiding Questions with Connections to Mathematical Practices:

How are inverse operations one of many useful strategies in solving equations?

M.P.1. Make sense of problems and persevere in solving them. Recognize that addition and subtraction “undo” one another when solving for a variable because they are inverse operations, and recognize that multiplication and division are inverse operations as well. For example, in the equation $x + 2 = 3$, the variable x can be isolated by subtracting 2 from both sides of the equation because subtracting 2 is the inverse of adding 2, and the equation is still balanced. Similarly, in the equation $3x = 6$, the variable x can be isolated by dividing both sides of the equation by 3 because dividing by 3 is the inverse of multiplying by 3. Additionally, understand that when additive operations “undo” one another in an equation, the result is the variable being increased by 0, which is the same as the variable itself, and when multiplicative operations “undo” one another in an equation, the result is the variable being multiplied by 1, which is the same as the variable itself.

- Ask students to solve an equation using inverse operations to isolate the variable. For example, solve the equation $x - \frac{5}{8} = \frac{9}{8}$ for x . Because x is being decreased by $\frac{5}{8}$, the fraction $\frac{5}{8}$ needs to be added to both sides of the equation. This maintains equality and, when completed, the variable x is the only term remaining on the left side of the equation, and the right side of the equation becomes $\frac{14}{8}$, which can be represented as $\frac{7}{4}$.

$$x - \frac{5}{8} = \frac{9}{8}$$

$$x - \frac{5}{8} + \frac{5}{8} = \frac{9}{8} + \frac{5}{8}$$

$$x = \frac{14}{8}$$

$$x = \frac{7}{4}$$

Additionally, for the equation $4 = \frac{2}{5}x$, since the variable is being multiplied by $\frac{2}{5}$, dividing both sides of the equation by $\frac{2}{5}$ (or, in this case, multiplying both sides of the equation by $\frac{5}{2}$) will isolate the variable. This maintains equality, and the variable x will be the only term remaining of the right side of the equation, while the left side becomes $\frac{20}{2}$, which can be represented by 10.

$$4 = \frac{2}{5}x$$

$$\frac{5}{2} \cdot 4 = \frac{5}{2} \cdot \frac{2}{5}x$$

$$\frac{20}{2} = x$$

$$10 = x$$

- Ask students to identify and correct common errors made while solving an equation. Give students the example “A student solved the equation $z + 5 = 12\frac{1}{3}$ by adding 5 to both sides of the equation to get the solution $17\frac{1}{3}$.” Explain that the error made was adding 5 more to the left side of the equation when the variable is being increased by 5. This operation would create the expression $z + 10$ on the left side of the equation. Therefore, determine that both sides of the equation need to be reduced by 5. Thus, the correct solution is $z = 7\frac{1}{3}$.

$$z + 5 = 12\frac{1}{3}$$

$$z + 5 - 5 = 12\frac{1}{3} - 5$$

$$z = 7\frac{1}{3}$$

Additionally, give students the example “A student solved the equation $6 = 4y$ by subtracting 4 from both sides of the equation to get the solution $2 = y$.” Explain that the error made was subtracting in an attempt to “undo” multiplication. Since the variable is being multiplied by 4, dividing both sides of the equation by 4 will yield the correct solution of $\frac{6}{4}$, which can be represented as $\frac{3}{2}$.

$$6 = 4y$$

$$6 \div 4 = 4y \div 4$$

$$\frac{6}{4} = y$$

$$\frac{3}{2} = y$$

How can a variable be used to represent an unknown quantity in real-world and mathematical problems?

M.P.2. Reason abstractly and quantitatively. Represent a situation symbolically, attending to the meaning of the variable. Solve the written equation and make sense of the solution in the context of the situation. For example, represent the situation “Maeva had \$36.48. Her friend gave her a jar full of coins, and then Maeva had \$52.98.” Use the equation $36.48 + x = 52.98$, where x is the amount of money in the coin jar. Solving the equation yields $x = 16.5$, which means that Maeva’s friend gave her \$16.50 in coins. The answer makes sense when estimation, subtraction, or the context of the problem is used to check it. Additionally, understand that key words and phrases in a given context determine what mathematical symbols can be used to represent them.

- Ask students to write and solve an equation to represent a given situation. For example, give students the situation “Sawyer purchased a pair of pants that were on sale for \$5.50 off the original price. Sawyer paid \$22.25 for the pants. What was the original price?” Determine that the unknown quantity that can be represented using a variable is the original price of the pants, p . The situation states that the pants were on sale for \$5.50 off the original price, which means the expression $p - 5.50$ can be used to represent the cost after the discount. Since the cost after the discount is \$22.25, setting the expression that is equivalent to the cost after the discount is equal to the cost. Thus, $p - 5.50 = 22.25$. Solve the equation by adding 5.50 to both sides to get the solution $p = 27.75$.

$$p - 5.50 = 22.25$$

$$p - 5.50 + 5.50 = 22.25 + 5.50$$

$$p = 27.75$$

Verify the solution in the context of the situation by confirming that when \$27.75 is reduced by \$5.50, the result is \$22.25, meaning that the original cost of the pants was \$27.75.

- Ask students to identify and correct errors made when representing a given situation using an equation, giving the reasoning for the error and the correct solution. For example, give students the situation “Lucy gave $\frac{1}{4}$ of her baseball cards to her younger brother. She had 126 cards remaining in her collection after she gave the cards to her brother. A student determined that Lucy originally had 504 cards by writing and solving the equation $\frac{1}{4}c = 126$, where c is the number of cards that Lucy originally had.” Explain that the error the student made was that while Lucy gave away $\frac{1}{4}$ of her cards, the amount of cards she still has is not represented by the expression $\frac{1}{4}c$. Lucy gave away $\frac{1}{4}$ of her cards, which means she kept $\frac{3}{4}$ of her cards. The correct equation that should be used is therefore $\frac{3}{4}c = 126$. This equation can be solved by dividing both sides of the equation by $\frac{3}{4}$ (which is the same as multiplying both sides by $\frac{4}{3}$). Doing this yields the solution to the equation $c = \frac{504}{3}$, which is equivalent to $c = 168$.

$$\frac{3}{4}c = 126$$

$$\frac{4}{3} \cdot \frac{3}{4}c = \frac{4}{3} \cdot 126$$

$$c = \frac{504}{3}$$

$$c = 168$$

Conclude that this means the correct number of cards that Lucy originally had was 168.

Key Academic Terms:

equation, variable, inverse operation, unknown, isolate, subtraction property, addition property, distributive property

Additional Resources:

- Lessons: [Expressions and equations](#)
- Lesson: [Balancing number sentences to introduce missing values](#)
- Article: [How to teach solving equations](#)

Expressions and Equations

Reason about and solve one-variable equations and inequalities.

19 Write an inequality of the form $x > c$ or $x < c$ to represent a constraint or condition in a real-world or mathematical problem. Recognize that inequalities of the form $x > c$ or $x < c$ have infinitely many solutions; represent solutions of such inequalities on number line diagrams.

Guiding Questions with Connections to Mathematical Practices:**How does an inequality compare to an equation?**

M.P.2. Reason abstractly and quantitatively. Recognize that equations and inequalities are both mathematical sentences, where “=” indicates that two quantities are equal, “<” indicates the first number is less than the second, and “>” indicates that the first number is greater than the second. For example, the mathematical sentence $x = \frac{6}{5}$ indicates that x has the same value as $\frac{6}{5}$, while the mathematical sentence $\frac{8}{4} < p$ indicates that the value of p is any and all values greater than $\frac{8}{4}$. Additionally, understand that an inequality can be stated in two different but equivalent forms and know how to represent an inequality in its equivalent form. For example, the inequality $\frac{5}{9} < y$ states that $\frac{5}{9}$ is less than y , which is equivalent to stating that y is greater than $\frac{5}{9}$, so the inequality can also be represented as $y > \frac{5}{9}$.

- Ask students to use an inequality to represent a given situation. For example, “The price of a movie ticket changes depending on the time and day. The cost is always less than \$9.” To determine the price of the ticket, represent it using a variable, p . Since the price of a ticket is always less than \$9, the inequality $p < 9$ can be used to describe the set of possible prices of a ticket.

- Ask students to determine when a given situation is best represented using an equation or an inequality, using key words and phrases in the situation and reasoning to explain why an equation or inequality best fits the situation. For example, given the situation “Sophia eats at least 2,000 calories per day,” students should determine that the situation is best represented using an inequality. Students should understand that the phrase “at least” indicates that the relationship between the number of calories Sophia eats and the given value of 2,000 is a relationship that should NOT be represented using an equals sign. Therefore, the number of calories Sophia consumes can be represented using a variable, c , creating the inequality $c \geq 2,000$ to best represent this situation. Explain that the inequality $2,000 \leq c$ is equivalent because if the number of calories must be greater than or equal to 2,000, so 2,000 must be less than or equal to the number of calories.

What is the meaning of a solution set to an inequality?

M.P.2. Reason abstractly and quantitatively. Understand that an inequality may have more than one solution. An inequality can have many solutions, and those solutions are called a solution set. For example, the inequality $x > 3$ has infinitely many solutions in its solution set because there is an infinite number of values that are larger than 3. Additionally, understand that all inequalities of the form $x > c$ or $x < c$ where c is a real number have an infinite number of solutions unless the inequality is being used to represent a contextual problem for which certain solutions are not meaningful in the context. Further, understand that when an algebraic relationship has an infinite number of solutions, it is not the same as saying that the solution set is represented by all real numbers.

- Ask students to describe the solution set to a given inequality using words. For example, given the inequality $4 > z$, determine that the solution set is the infinite set of numbers that are less than 4 because the inequality states that 4 must be greater than z . Explain that this includes all negative numbers as well as the positive numbers that are less than 4.
- Ask students to identify common errors in determining the solution set to an inequality and describe the correct solution set. For example, “A student described the solution set to the inequality $a > 2$ as all numbers 3 and greater.” To determine the error the student made and give the correct solution set, explain that while 2 is not a solution to the inequality, there is a set of numbers between the whole numbers 2 and 3. All of these numbers make the inequality true and are therefore solutions to the inequality. The correct solution set to the inequality can only be described as all values greater than 2 because there is no other way to describe the smallest possible value that is a solution to the inequality.

- Ask students to compare the solution set to an inequality that represents a given context with the meaningful solution set placed in the context of the situation. For example, “A city regulation states that the number of dogs a person who lives in that city can own must be less than 4. The inequality $d < 4$, where d is the number of dogs owned, can be used to represent this situation.” Explain that the solution set to the inequality is the infinite set of numbers that are less than 4. However, the meaningful solution set to the situation does not include all numbers less than 4 because the variable represents the number of dogs owned, so only the whole number, nonnegative values in the solution set of the inequality are meaningful in the context of the situation. Therefore, only the numbers 0, 1, 2, and 3 are solutions to the inequality and also meaningful solutions in the context of the situation.

M.P.6. Attend to precision. Represent a real-world solution set of an expression with an inequality. For example, when given the context “Sara runs 7.4 feet every s seconds,” the solution set would be $s > 0$ because Sara can only run for more than 0 seconds, and there would be a reasonable upper limit to the solution as well because Sara cannot run for infinite positive seconds. Additionally, describe contexts in which the solution set to the context can only be represented using positive numbers. Further, describe contexts in which the solution set to the context can only be represented using whole numbers.

- Ask students to represent the solution set of a given real-world context using an inequality. For example, “Mike scored no more than 12 points in each of his team’s last 5 basketball games.” The unknown quantity, the number of points scored in each game, can be represented by a variable, p . The relationship between the number of points and the given value of 12 can be represented using a \leq symbol. The inequality $p \leq 12$ can therefore be used to represent the situation where only whole number values of p are meaningful solutions to the problem, as the number of points can only be measured in whole numbers.
- Ask students to write a real-world situation whose solution set can be represented using a given inequality. For example, “Write a real-world situation for which the solution set is $-3 > x$.” To determine that the solution set represented is all numbers that are less than -3 , explain that the inequality states that -3 must be greater than the unknown quantity, x . Discuss the types of real-world situations that can be represented using negative numbers. These include but are not limited to temperature, elevation compared to sea level, or the balance of a bank account. Determine that the inequality could be used to represent that the temperature was below -3 degrees for the duration of a day and write the real-world situation “The weather forecast for the temperature in Bridgeport says that it will be less than -3°C for the entire day.” Additionally, explain that in the context of the situation, there is an unspecified reasonable lower limit to the temperature.

How are number lines useful for representing the solution set of an inequality?

M.P.4. Model with mathematics. Represent more than one solution, including infinitely many solutions, with an open circle, shading, and an arrow on a number line. For example, the solution set of the inequality $x < 4$ can be shown on a number line with an open circle at 4 and shading and an arrow to the left of 4. Additionally, understand that because the solution set to an inequality of the form $x < c$ or $x > c$, where c is a real number, is an infinite set of values, the number line indicates the endpoint and the shading and the arrow indicate the value of the solutions relative to the endpoint, as the entire solution set cannot be listed or graphed with discrete points on a number line.

- Ask students to represent the solution set to an inequality using a number line. For example, represent the inequality $f < 4$. Construct a number line containing the point 4 and values larger and smaller than 4, such as $\frac{7}{2}$ and $\frac{9}{2}$. Plot a point at the endpoint of the solution set, 4. This endpoint should be an open circle, meaning that it is not included in the solution set. Explain that the endpoint is 4 and not a value less than 4 because there is no tangible way to represent a number that is as close as possible to 4 but less than 4 because there is always another number in between two numbers in the real number system. Draw an arrow to the left of the endpoint, as the inequality symbol indicates that the solution set is all values less than 4 on the number line.

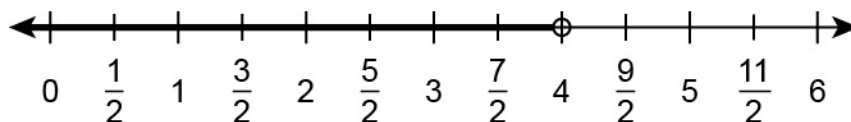

- Ask students to write an inequality given a solution set shown on a number line graph. For example, write an inequality whose solution set is shown on the number line graph.

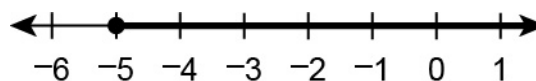

The endpoint on the graph is -5 . The endpoint is included in the solution set because its circle is closed, so the inequality must include -5 as a solution. The values indicated by the arrow are the values that are greater than -5 because the arrow from the endpoint goes to the right. On a number line, values increase as they go further right. Select a variable, such as w , to represent the unknown quantity and write the inequality $w \geq -5$, indicating that the inequality's solution set consists of all values that are greater than or equal to -5 , which is the solution set shown on the graph.

How do you know if a solution is feasible?

M.P.3. Construct viable arguments and critique the reasoning of others. Understand that solutions to inequalities modeling real-world situations may include answers that are not accurate in the context of the situation. For example, 23 members of a local choir will be going on a trip. The choir will be taking vans that will each carry up to 5 choir members. Write an inequality to represent the number of vans, v , the choir can take. The inequality can be written as $v > 23 \div 5$ or $v > 4.6$. While $v = 5.5$ is a solution to the inequality $v > 4.6$, 5.5 vans is not a feasible solution because it is not possible to take 0.5 of a van. Additionally, understand that for certain types of situations in which the variable represents an unknown quantity that can only be measured in whole numbers, the mathematical solution to the inequality is not the same as the solution set in the context of the situation. Further, understand that for certain types of situations in which the variable represents an unknown quantity that can only be measured using the positive numbers, the mathematical solution may only contain an upper limit, while the solution set in the context of the situation may contain both an upper and lower limit.

- Ask students to use an inequality to represent a real-world situation and compare the mathematical solution set to the solution set in the context of the situation. For example, "Grace is helping to plan the pizza party for the student council at her school. One pizza can feed as many as 4 students. There are 35 students on the student council. Write an inequality to determine the possible number of pizzas Grace can order. Compare the mathematical solution set of the inequality with the solution set in the context of the situation." Determine that the unknown quantity that will be represented by a variable, x , is the number of pizzas Grace orders. The inequality that can be used to represent the situation is $x \geq 35 \div 4$, or $x \geq 8.75$, because each pizza can feed as many as 4 students. Compare the solution set of the inequality with the solution set in the context of the situation by explaining that the solution set of the inequality is every real number that is greater than 8.75, including numbers such as 8.76 and 8.8. The solution set in the context of the situation is all whole numbers 9 and greater. Explain that the situation would also have an undetermined upper limit to the number of pizzas Grace would order.

- Ask students to explain errors made in interpreting mathematical solutions to inequalities in the context of the real-world situations they represent and to find the correct solution set in the context of the situation. For example, “Neal and Abdi go to an arcade. Neal purchases 16 tokens to use in the machines and Abdi purchases fewer tokens than Neal. A student determined that the inequality $t < 16$ can be used to represent the number of tokens Abdi could have purchased. The student stated that possible solutions for the number of tokens Abdi could have purchased therefore include 15.5, 10, 7.75 and -3 .” Determine that the error the student made was giving possible solutions that are not meaningful solutions in the context of the situation. While 10 is part of the solution set in the context of the situation, the other solutions the student gave are mathematical solutions to the inequality, but they are not meaningful in this context because they are not whole numbers. The numbers that are both part of the mathematical solution set of the inequality and part of the meaningful solution set in the context of the situation are the whole numbers between 0 and 15, including both 0 and 15.

Key Academic Terms:

inequality, equation, solution set, equal, greater than, less than, open circle, closed circle, number line, infinitely many, feasible

Additional Resources:

- Tutorial: [How do you graph an inequality or an infinite set on a number line?](#)
- Lesson: [Inequalities](#)

Expressions and Equations

Represent and analyze quantitative relationships between dependent and independent variables.

20 Use variables to represent two quantities in a real-world problem that change in relationship to one another; write an equation to express one quantity, thought of as the dependent variable, in terms of the other quantity, thought of as the independent variable. Analyze the relationship between the dependent and independent variables using graphs and tables, and relate these to the equation.

Example: In a problem involving motion at constant speed, list and graph ordered pairs of distances and times, and write the equation $d = 65t$ to represent the relationship between distance and time.

Guiding Questions with Connections to Mathematical Practices:**What do independent and dependent variables represent in an equation?**

M.P.2. Reason abstractly and quantitatively. Identify the independent variable as the “input” of an equation and the dependent variable as the “output” of an equation. Show that the value of the dependent variable is contingent on (depends on) the value of the independent variable. For example, if the equation $p = 0.75m$ is used to represent a total number of pages read, p , after m minutes, then m is the independent variable and p is the dependent variable. The number of pages read depends on the number of minutes spent reading. Additionally, understand that when a relationship is represented using an equation, the dependent variable is often (but not always) isolated on one side of the equation and a rule containing the independent variable makes up the expression on the other side of the equation.

- Ask students to identify the independent variable as the “input” of an equation and the dependent variable as the “output” of an equation given an equation. For example, “The equation $m = 15w$ represents the amount of money, m , Kayla has saved after w weeks.” Determine that the dependent variable is the amount of money, m , that Kayla has saved. The amount of money changes based on the number of weeks, which makes it the dependent variable. This means that the number of weeks is the independent variable, as the number of weeks is not changed by the amount of money.

- Ask students to determine how the dependent variable changes based on changes to the independent variable given an equation representing a relationship. For example, “The equation $d = \frac{1}{15}m$ yields the distance, d , in miles, that Jacob has walked after m minutes.” Determine that Jacob’s distance is dependent on the time for which he has been walking, and when Jacob walks for 15 minutes, the change in the distance that he has walked is equal to $\frac{1}{15}(15)$ or 1 mile.

How can the meaning of the variables be used to determine the variable that is independent and the variable that is dependent?

M.P.1. Make sense of problems and persevere in solving them. Analyze the problem to define the meaning of each variable to help discern which variable is independent and which is dependent. For example, given the situation “Imani buys one box of pencils that costs \$2.99 and n notebooks that cost \$1.89 per notebook. She spends a total of t dollars for the box of pencils and the notebooks,” determine that n is the number of notebooks and is the independent variable, and t is the total cost, dependent on the number of notebooks, so it is the dependent variable. Additionally, understand that change in the independent variable causes change in the dependent variable in a particular way, and asking which variable changing will logically cause the change in the other variable is a useful tool in determining which variable is the independent variable and which is the dependent variable in a given situation.

- Ask students to determine the independent and dependent variables given a relationship between two quantities. For example, “A bag of dog food has a chart on it that has a recommended amount to feed dogs based on different weight ranges.” Determine that the variables in the situation are the amount of dog food and the weight of the dog. This means that the amount of dog food will depend on the weight of the dog. The amount of dog food is therefore the dependent variable and the weight of the dog is the independent variable.
- Ask students to analyze and correct common errors made when determining the independent variable and dependent variable in a relationship. For example, “Lisa can run 6.5 miles per hour. A student stated that the independent variable in this situation is the amount of time for which Lisa runs and the dependent variable is 6.5.” Determine that the student correctly gave the independent variable in the situation as the amount of time for which Lisa runs. Explain that the error the student made was using the constant value as the dependent variable. The dependent variable that changes as a result of the amount of time for which Lisa runs is the total distance that Lisa runs.

How can the relationship between an independent variable and a dependent variable be expressed in a graph or table?

M.P.4 Model with mathematics. Recognize that a table or graph can be used to show the same relationship between an independent variable and a dependent variable that is expressed in an equation. For example, a table indicating that 3 ice cream cones cost \$4.50 and 5 ice cream cones cost \$7.50 represents the same relationship as the equation $p = 1.5c$, where the dependent variable, p , is the total cost of c ice cream cones. Additionally, understand that the horizontal axis is used to represent the independent variable and the vertical axis is used to represent the dependent variable when a relationship is expressed as a graph.

- Ask students to write an equation that represents the same relationship that is given in a table. For example, “The table shows the cost to rent roller skates based on the amount of time they are rented.”

Time in Hours	Cost to Rent Skates
2	\$7.00
3	\$10.50
4	\$14.00
5	\$17.50

Determine that the cost changes by \$3.50 between two hours and three hours. This cost per hour, h , can be multiplied by 2 to get 7 or by 3 to get 10.5, so the cost to rent roller skates can be represented as $3.5h$. The equation that represents the cost, c , in this relationship is therefore $c = 3.5h$.

- Ask students to write an equation that represents the same relationship as one given as a graph. For example, “The graph shows the number of pages remaining in Xavier’s book based on the number of hours he spent reading.”

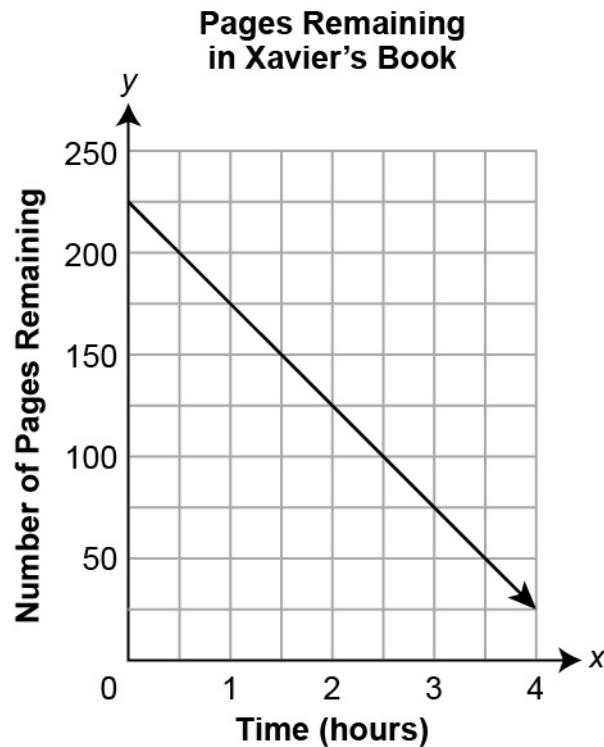

Explain that the number of pages remaining in Xavier’s book, y , is dependent on the number of hours for which he reads, x . Explain that the number of pages the book contains is 225 because when Xavier has read for 0 hours, there are 225 pages remaining to read. Explain that Xavier reads 50 pages per hour because after 1 hour, there were 175 pages remaining to read, and the difference between 225 and 175 is 50. The number of pages remaining in Xavier’s book can therefore be represented by subtracting the number of hours he reads multiplied by 50 from the initial number of pages. The equation $y = 225 - 50x$ can therefore be used to represent the relationship.

Key Academic Terms:

independent variable, dependent variable, variable, equation, table, graph

Additional Resources:

- Lesson: [Solving for independent and dependent variables](#)
- Activity: [Families of Triangles](#)

Geometry

Solve real-world and mathematical problems involving area, surface area, and volume.

21 Find the area of right triangles, other triangles, special quadrilaterals, and polygons by composing into rectangles or decomposing into triangles and other shapes; apply these techniques in the context of solving real-world and mathematical problems.

Guiding Questions with Connections to Mathematical Practices:

How can the formula for the area of a rectangle be used to find the area of a parallelogram?

M.P.1. Make sense of problems and persevere in solving them. Use a concrete model to visualize a triangular portion from one side of a parallelogram “cut off” and repositioned on the other side of the parallelogram to create a rectangle so that the base of the parallelogram equals the length of the new rectangle and the height of the parallelogram equals the width of the new rectangle. For example, a parallelogram with a base of 10 inches and a height of 5 inches can be changed to create a rectangle with a length of 10 inches and a width of 5 inches that has an equivalent area. Additionally, recognize that it is the height of the parallelogram, not the measurement of the slant height, that determines the area.

- Ask students to manipulate the concrete model of a parallelogram into a rectangle in order to determine the area of the parallelogram. In the example shown, a student has shaded the triangular portion of the figure formed by the dashed line labeled with a height of 6 inches and repositioned the triangular piece to form a rectangle in order to calculate the area as 54 square inches.

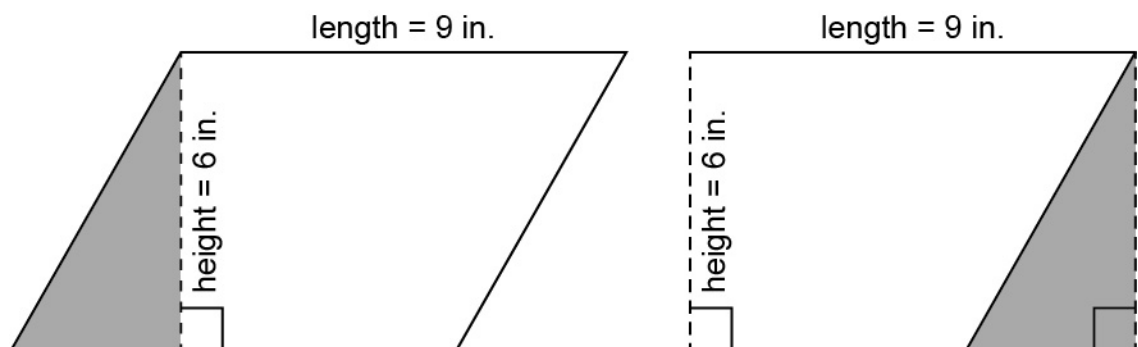

- Ask students to manipulate a concrete model of a rectangle into a parallelogram of the same area by removing a trapezoidal piece from one end and placing it at the other end. In the given example, a student has drawn a nonparallel line to divide the rectangle and removed the shaded region so as to place it at the other end, creating a parallelogram with the same area of 56 square inches.

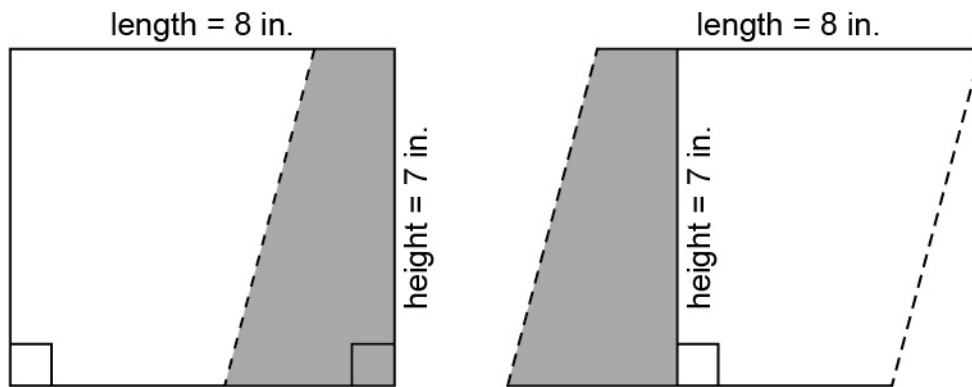

Ask students to compare their parallelograms and observe that even though their parallelograms appear different and the lengths of the sides of their parallelograms are different, the bases and heights are equivalent and therefore the areas are also equivalent.

How can the formula for the area of a parallelogram be used to find the area of a triangle?

M.P.1. Make sense of problems and persevere in solving them. Use a concrete model to recognize that a parallelogram with base b and height h can be divided into two equal triangles each with base b and height h , so the area of a triangle with base b and height h is half the area of a parallelogram with base b and height h . For example, the area of a parallelogram with a base of 8 centimeters and a height of 4 centimeters is 8×4 square centimeters, so the area of a triangle with a base of 8 centimeters and a height of 4 centimeters is half of 8×4 square centimeters. Additionally, two identical triangles with areas of 10 square centimeters can be joined to form a parallelogram with an area of 10×2 square centimeters.

- Ask students to bisect a concrete model of a parallelogram into two triangles of equal size so that the area of each triangle measures half the area of the parallelogram. For example, bisect a parallelogram with a base of 10 inches and a height of 6 inches to create two triangles, each with an area of 30 square inches.

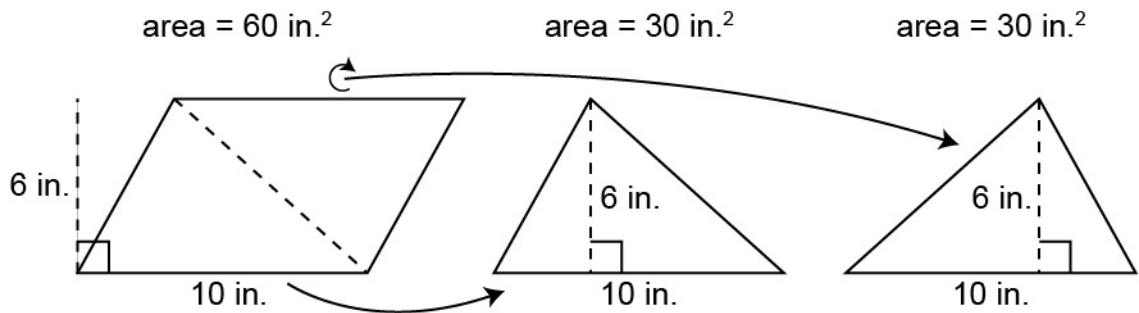

- Ask students to create two identical concrete models of a triangle, each with a base of 7 centimeters and a height of 4 centimeters, and join two congruent sides together to form a parallelogram that has twice the area of each triangle. In the example shown, determine that each triangle has an area of 14 square centimeters because the constructed parallelogram has an area of 28 square centimeters.

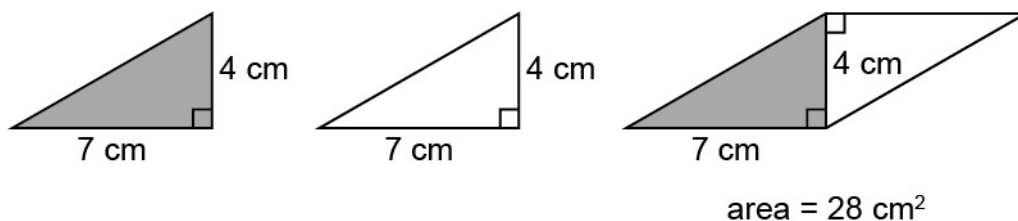

How can the area of a composite figure be determined using the area of smaller figures?

M.P.1. Make sense of problems and persevere in solving them. Recognize that if a composite figure is decomposed into smaller figures, then the area of the composite figure is equal to the sum of the areas of the smaller figures. For example, the area of an L-shaped patio is equal to the sum of the areas of the two rectangles that combine to make the L-shaped patio. Additionally, the area of a figure can be calculated by subtracting areas of smaller figures from larger figures. For example, the area of the L-shaped patio is equal to the area of a large rectangle minus the area of the rectangle that is not part of the patio.

- Ask students to determine the area of a composite figure by decomposing into smaller figures and calculating the sum of the areas of the smaller figures. In the example shown, students have determined the square footage of an apartment by using rectangles and a triangle. The total area is equal to the sum of the two rectangles and the triangle:
 $300 + 300 + 150 = 750$ square feet.

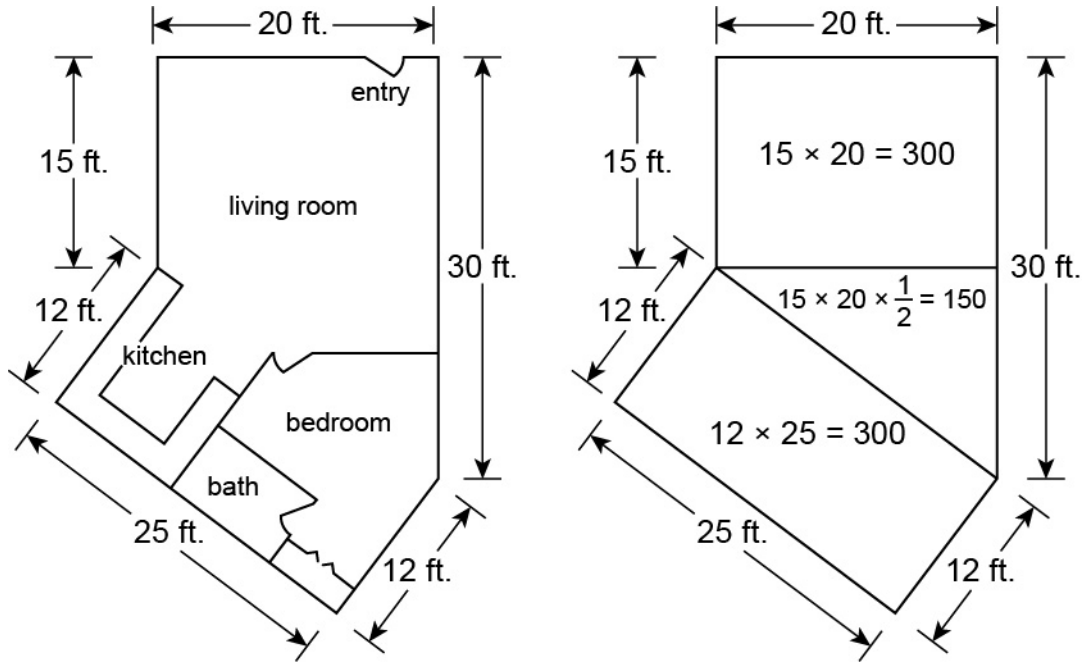

- Ask students to calculate the area of a shape that is “missing” pieces from the whole. For example, the area of a stop sign can be calculated by subtracting the areas of four right triangles on the corners from the encompassing square. The following image shows a square of 29 inches \times 29 inches = 841 square inches. The area of each corner triangle is $\frac{1}{2} \times 8.5 \times 8.5 = 36.125$ square inches. Therefore, the area of the stop sign is $841 - (4 \times 36.125) = 696.5$ square inches.

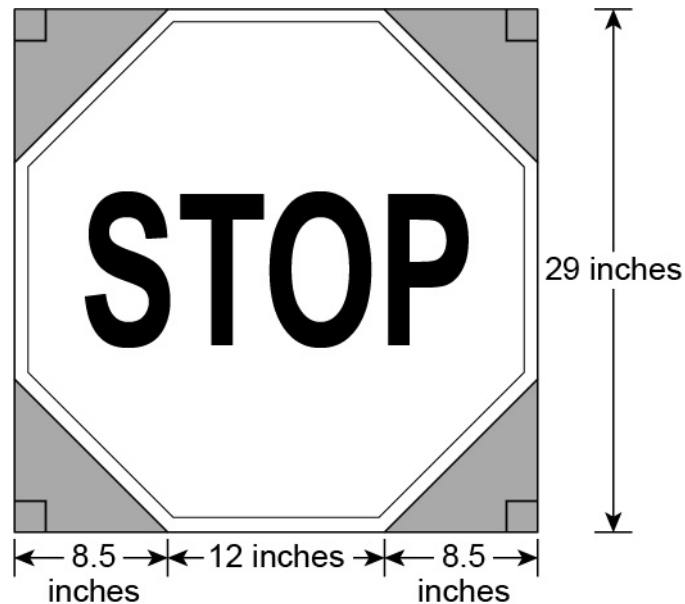

Key Academic Terms:

area, triangles, quadrilaterals, polygons, decomposition, composite, base, height

Additional Resources:

- Activity: [Finding the area of triangles and polygons](#)
- Video: [Area of a triangle: relation to rectangles](#)
- Video: [Area of a triangle](#)
- Video: [Calculating rectangular area | Cyberchase](#)
- Video: [Parallelogram, triangles, etc.](#)
- Lesson: [Finding area with hands-on measurement](#)

Geometry

Solve real-world and mathematical problems involving area, surface area, and volume.

22 Find the volume of a right rectangular prism with fractional edge lengths by packing it with unit cubes of the appropriate unit fraction edge lengths, and show that the volume is the same as would be found by multiplying the edge lengths of the prism. Apply the formulas $V = lwh$ and $V = Bh$ to find volumes of right rectangular prisms with fractional edge lengths in the context of solving real-world and mathematical problems.

Guiding Question with Connections to Mathematical Practices:

How is the process of determining the volume of prisms with fractional edge lengths similar to the process of determining the volume of prisms with whole-number edge lengths?

M.P.1. Make sense of problems and persevere in solving them. Extend previous understandings of how to calculate the volume of prisms with whole-number edge lengths to prisms with fractional edge lengths, and use manipulatives to better understand volume. For example, the process for determining the volume of a prism with a length of $\frac{1}{2}$ centimeter, a width of $\frac{1}{3}$ centimeter, and a height of $\frac{1}{4}$ centimeter is the same as determining the volume of a prism with a length of 2 centimeters, a width of 3 centimeters, and a height of 4 centimeters. Additionally, models of prisms composed of cubes are the same for prisms with whole-number edge lengths and fractional edge lengths, with the only difference being the size of the cubes.

- Ask students to find the volume of a cube whose edge lengths are a unit fraction by packing the fractional cubes into a unit cube. For example, pack cubes whose edge lengths are $\frac{1}{2}$ unit into a unit cube, as shown.

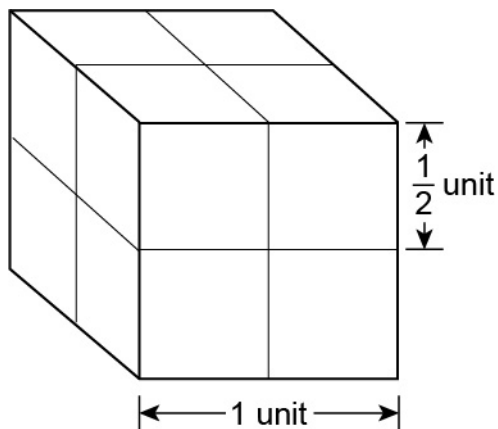

The entire unit cube has a volume of 1 cubic unit and 8 identical small cubes fill the unit cube. Therefore, each small cube has a volume of $\frac{1}{8}$ cubic unit. Observe that this volume is the same as would be found by multiplying the edge lengths of the cube, just like for cubes whose edge lengths are whole numbers.

- Ask students to pack a figure with cubes of unit fraction edge length to determine the volume of the figure. For example, a manufacturer of cubes packages cubes of edge length $\frac{1}{2}$ inch into a box that measures $1\frac{1}{2}$ inches by 2 inches by 3 inches. As noted previously, each cube has a volume of $\frac{1}{8}$ cubic inch. It takes 72 cubes to fill the box, therefore the volume of the box is 9 cubic inches.

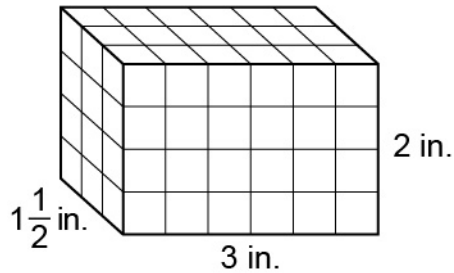

Observe that the volume of 9 cubic inches is the same as would be found by multiplying the edge lengths, just as with prisms whose edge lengths are whole numbers.

- Ask students to compare processes for finding the volumes of rectangular prisms having whole-number edge lengths versus fractional edge lengths. For example, ask students to compare the process for finding the volume of a prism with the dimensions $5 \times 4 \times 3$ and a prism with the dimensions $\frac{5}{4} \times \frac{4}{4} \times \frac{3}{4}$. Both prisms can be modeled with the same picture.

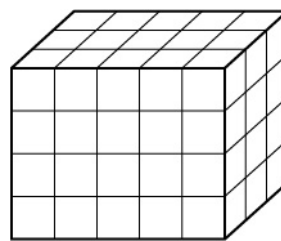

In the first case, each cube shown is a unit cube and there are 60 cubes. This yields a total volume of 60 cubic units. In the second case, each cube shown is a cube that measures $\frac{1}{4}$ unit on each edge and has a volume of $\frac{1}{64}$ cubic unit. As with the first case, there are 60 cubes. This yields a total volume of $\frac{60}{64}$ of a cubic unit. In both cases, the volume equals the product of the dimensions of the figure.

Key Academic Terms:

volume, prism, edge, right rectangular prism

Additional Resources:

- Activity: [Banana bread](#)
- Activity: [Volumes with fractional edge lengths](#)

Geometry

Solve real-world and mathematical problems involving area, surface area, and volume.

23 Draw polygons in the coordinate plane given coordinates for the vertices; use coordinates to find the length of a side joining points with the same first coordinate or the same second coordinate. Apply these techniques in the context of solving real-world and mathematical problems.

Guiding Questions with Connections to Mathematical Practices:**How can the coordinate plane be used to determine the side length of figures?**

M.P.6. Attend to precision. Utilize the axes on the coordinate plane as a measurement tool to determine side length. For example, if the vertices of the base of a triangle are plotted at $(-3, 0)$ and $(4, 0)$, then the length of the base can be determined as 7 units by counting the number of tick marks from -3 to 4 along the x -axis. Additionally, when the height of the triangle is given to be 4 units, a third vertex can be plotted at $(4, 4)$, and then the height and base length can be used to calculate the area.

- Ask students to calculate the area of a polygon given the coordinates of the vertices on the coordinate plane. For example, given the vertices of $(-9, 1)$, $(-9, 4)$, $(2, 1)$, and $(2, 4)$, the length of the rectangle is determined to be 11 units by counting the tick marks between -9 and 2 along the x -axis. The width is determined as 3 units by counting the tick marks between 1 and 4 along the y -axis. The lengths of the sides can then be used to find that the area of the rectangle is 33 square units.

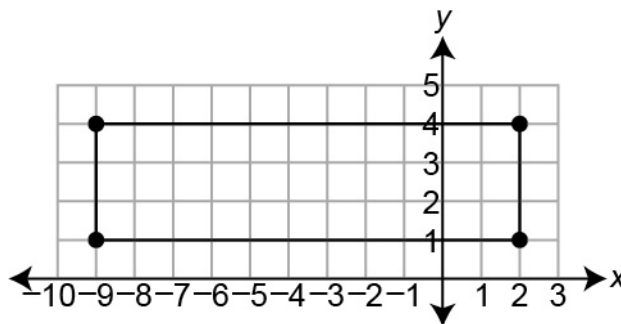

- Ask students to create polygons in the coordinate plane in order to represent grid-based movement. For example, the starting point and an ending point of a journey are represented by $(4, 1)$ and $(10, 5)$, respectively, on a coordinate plane. If units are measured in kilometers and movement is restricted to the horizontal and vertical directions as with many city streets, how far is the journey? Create a right triangle by plotting a point at $(10, 1)$. Then, calculate the distance traveled to the east as 6 kilometers by counting the tick marks from 4 to 10 along the x -axis and to the north as 4 kilometers by counting the tick marks from 1 to 5 along the y -axis.



How can the attributes of shapes be used to classify a figure on a coordinate plane?

M.P.3. Construct viable arguments and critique the reasoning of others. Use the coordinate plane and the characteristics of shapes to justify the shape of a drawn figure. For example, consider that a quadrilateral with one set of opposite sides having lengths of 5 units, the other set of opposite sides having lengths of 3 units, and having all right angles, must be a rectangle. Additionally, determine the locations of the vertices of a polygon given the attributes of the shape.

- Ask students to classify a polygon created by plotting a set of vertices. For example, a polygon that is constructed by connecting the points $(-1, 6)$, $(-1, 1)$, $(2, 0)$, $(4, 3)$, $(1, 6)$, and $(-1, 6)$ in order is classified as a pentagon since it has five sides.

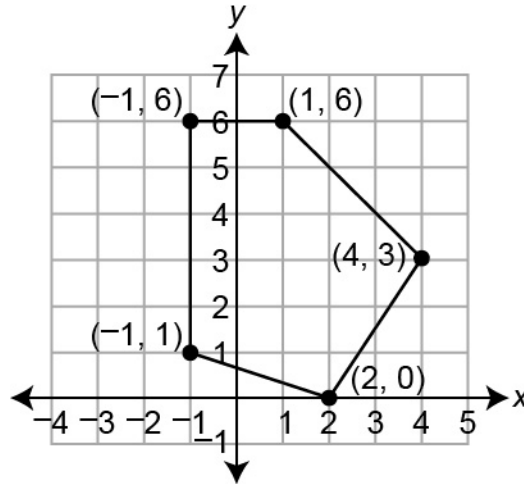

- Ask students to determine the location of a vertex or vertices to complete a designated polygon. For example, given the coordinates of $(1, 2)$ and $(1, 5)$ as two consecutive vertices of a square, the side length can be determined as 3 units by counting the number of tick marks from 2 to 5 along the y -axis. Additional vertices are plotted at $(4, 2)$ and $(4, 5)$ by counting 3 tick marks to the right along the x -axis from each of the given points. An alternate solution exists by plotting points at $(-2, 2)$ and $(-2, 5)$.

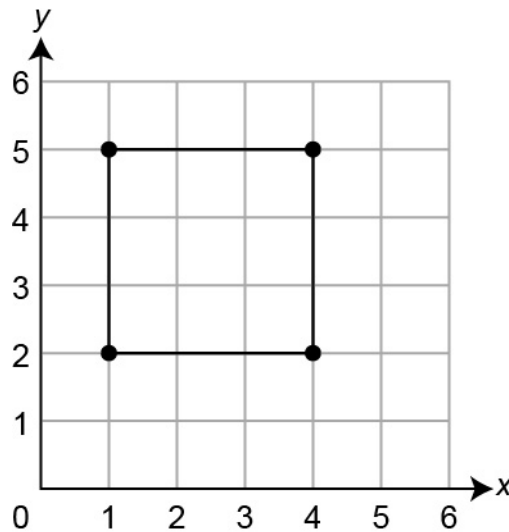

- Ask students to plot points on the coordinate plane to create polygons that have a set of given attributes. For example, given a right triangle with two legs measuring 5 units that each have a vertex at $(-2, 0)$, plot additional points at $(3, 0)$ and $(-2, 5)$. Alternate solutions also exist, such as plotting points at $(-2, -5)$ and $(-7, -5)$.

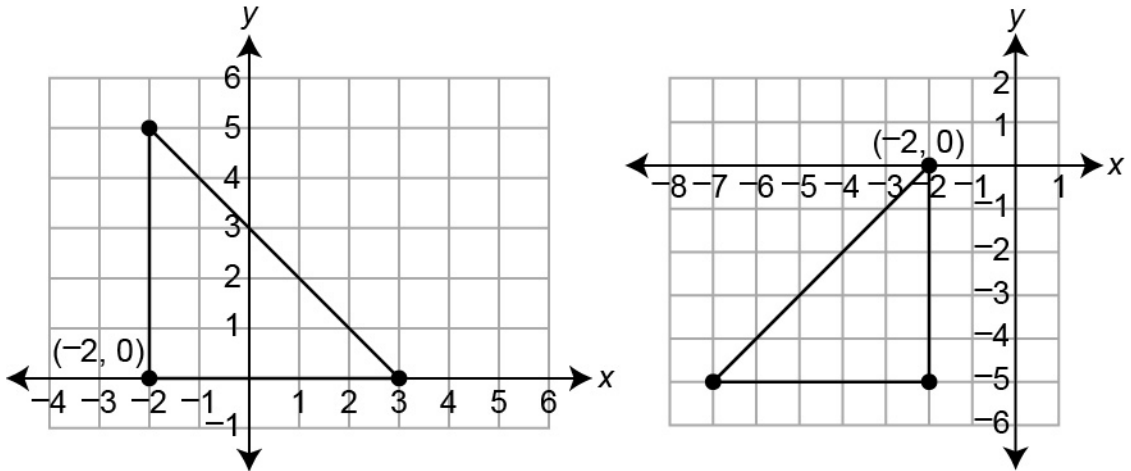

Key Academic Terms:

vertices, coordinates, coordinate plane, axis, attributes

Additional Resources:

- Video: [Polygons in the coordinate plane](#)
- Lesson: [Polygons on the coordinate grid](#)
- Lesson: [Measuring polygons on the coordinate plane](#)
- Lesson: [Plotting polygons with GeoGebra](#)

Geometry

Solve real-world and mathematical problems involving area, surface area, and volume.

24 Represent three-dimensional figures using nets made up of rectangles and triangles, and use the nets to find the surface area of these figures. Apply these techniques in the context of solving real-world and mathematical problems.

Guiding Question with Connections to Mathematical Practices:

What is a net and how is it useful for determining the surface area of a three-dimensional figure?

M.P.4. Model with mathematics. Recognize that a three-dimensional figure can be “flattened” or “unfolded” to create a two-dimensional figure called a net that shows each face simultaneously, and recognize that the sum of the area of each face is equal to the entire surface area. For example, the net of a cube with side length 3 units consists of 6 faces that each have an area of 9 units, making the surface area of the cube 54 square units. Additionally, the net of a right square pyramid with base side length 8 units and slant height 5 units consists of one square with an area of 64 square units and four triangles, each with an area of 20 square units, such that the total surface area is 144 square units.

- Ask students to construct a net for a three-dimensional figure. For example, given a rectangular prism with edge lengths of 2 centimeters, 5 centimeters, and 6 centimeters, use graph paper to draw a net with side lengths labeled. Additionally, if necessary, cut and fold the nets into the rectangular prisms in order to verify the models.

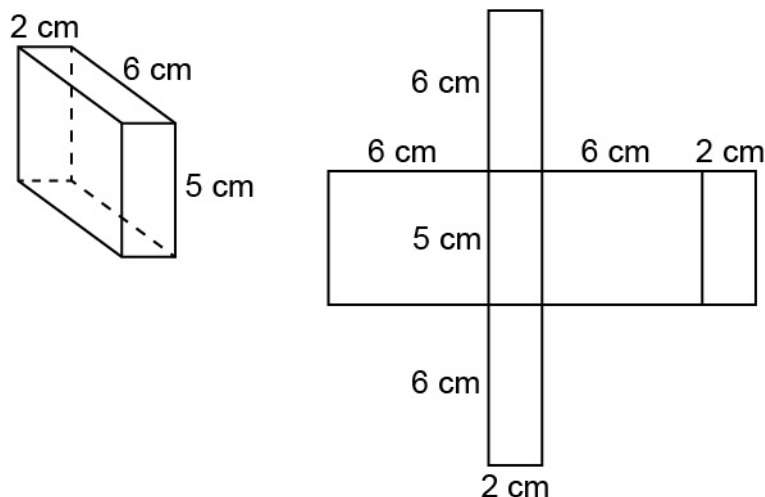

- Ask students to deconstruct a physical model of a three-dimensional figure into a net and calculate the surface area by finding the sum of the areas of the shapes in the net. For example, a box with dimensions 12 inches by 15 inches by 3 inches can be cut in multiple ways to form a net, with two rectangles having areas of 180 square inches each, two rectangles having areas of 45 square inches each, and two rectangles having areas of 36 square inches each, for a total surface area of 522 square inches.

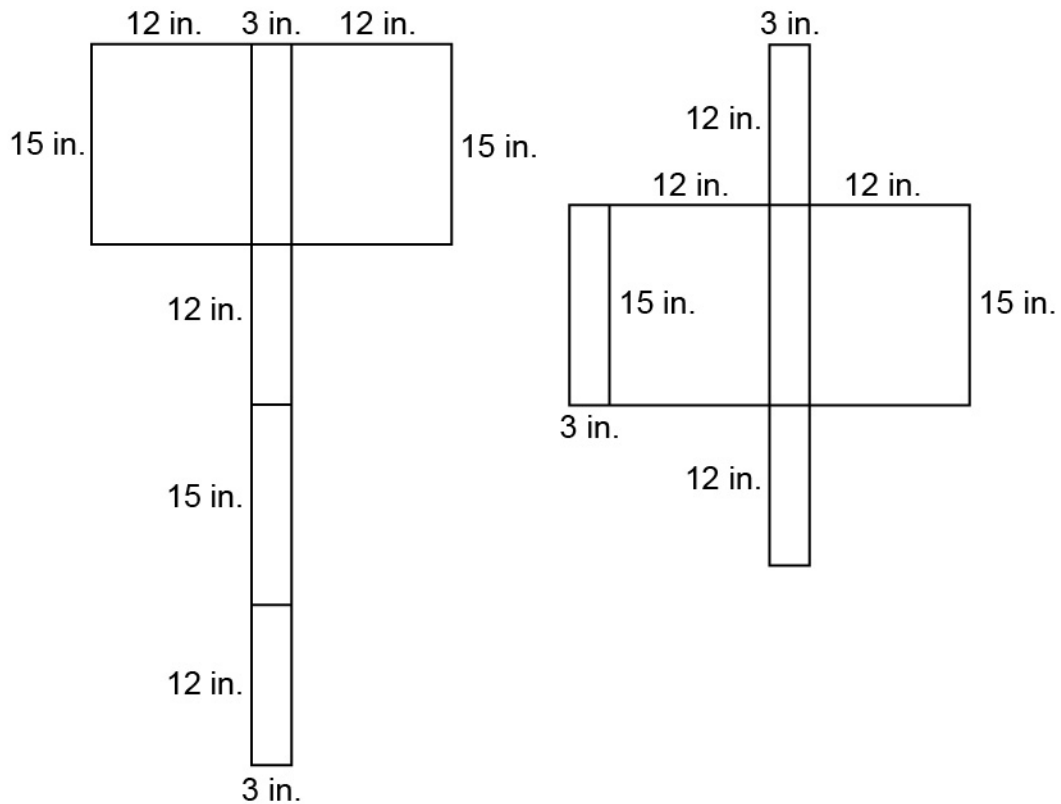

- Ask students to determine the surface area of a three-dimensional figure when given a net for the figure. For example, for the net shown, the area of each triangle is calculated as 6 square inches, the area of the larger rectangle is calculated as 15 square inches, the area of the smaller rectangle is calculated as 12 square inches, and the area of the square is calculated as 9 square inches. Thus, the surface area of the prism is the total sum, 48 square inches. Additionally, if necessary, cut and fold the net in order to construct the three-dimensional figure.

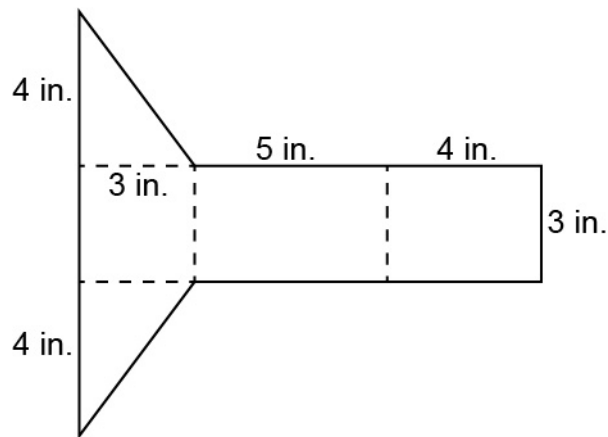

Key Academic Terms:

surface area, net, three-dimensional

Additional Resources:

- Lesson: [All wrapped up in surface area fun!](#)
- Article: [5 expert activities for teaching surface area](#)
- Video: [Nets](#)
- Video: [Prisms with quadrilateral faces](#)
- Article: [Teaching volume and surface area with interactive materials](#)

Statistics and Probability

Develop understanding of statistical variability.

25 Recognize a statistical question as one that anticipates variability in the data related to the question and accounts for it in the answers.

Example: “How old am I?” is not a statistical question, but “How old are the students in my school?” is a statistical question because one anticipates variability in students’ ages.

Guiding Questions with Connections to Mathematical Practices:**How is variability affected by the way a question is posed?**

M.P.2. Reason abstractly and quantitatively. Understand that the wording or framing of a question affects whether there is variation in the answers. For example, asking people how many state capitals there are in the US does not allow for variation, but asking people how many state capitals they have visited does allow for variation in the data set. Additionally, understand that the population to which a question is posed affects whether there is variation in the answers.

- Ask students to create questions with numeric answers that both allow and do not allow for variation. First, students should each come up with a question for which the responses cannot have any variation. Then, students should each come up with a second question—ideally, one that is related to the first question—for which the responses can have variation. For example, two related questions could be:
 - How many African countries are there?
 - How many African countries can you name?

The first question is not a statistical question because it does not allow for variation in the answer when answered correctly. The second question is a statistical question because it allows for variation in the answer.

- Ask students to describe populations for which a given question might elicit responses with or without variation. For example, the question “What grade are you in?” might elicit responses with variation when asked to members of a random sample of high school students. However, that same question will not elicit responses with variation when asked to members of a class consisting entirely of students in grade 6.

How is variability shown in a data set?

M.P.6. Attend to precision. Understand that variability refers to a spread of values in a data set. For example, the variability of the data set {1, 2, 3, 4, 5} is greater than the variability of the data set {1, 1, 1, 1, 2}. Additionally, understand that the spread is affected by the relationship or distance between the values in the data set rather than the specific, individual values in the data set.

- To illustrate that variability is not the same as variety, or amount of variation, show students the data sets {1, 1, 1, 10, 10, 10} and {1, 2, 3, 4, 5, 6}. The first set has more variability, despite the fact that it has values with less variety, because there is a greater spread between the largest and smallest values.
- Ask students to describe or plot on a number line sets with different variabilities, beginning with a set that has no variability. For example, students could begin by plotting the data set {3, 3, 3, 3, 3, 3}.
 - Connect the set with the concept of a nonstatistical question. For example, the set could come from asking a group of third-grade students what grade they are in. When students in third grade are asked their grade level, the question does not allow for variation and is therefore not a statistical question.
 - Next, ask students to adjust the data set one point at a time to increase its variability. After the first two changes, a sample data set might be {2, 3, 3, 3, 3, 4}. This data set could have come from asking a group of students waiting for a school bus what grade they are in. The question is statistical because it allows for variation. Students should observe that in this particular case, the points spread out on the number line as the variability increases and the shape of the graph changes from having a single peak to being flatter.
- To illustrate that variability is affected by the spread rather than the specific values in a data set, provide students with two data sets that have the same variability but different values. For example, {2, 2, 3, 4, 5, 5} and {6, 6, 6, 7, 8, 9}. Ask students to create a line plot for each data set on a separate number line. Each number line should be on a different sheet of paper, but the number lines should be identical in terms of spacing between each value. Then, have students place the pieces of paper on top of one another so the data sets are aligned. Students should see that the data sets have the same spread, even though the values are different, and that this sameness is illustrated by the fact that the left-most point and the right-most point of the two graphs align with each other.

Key Academic Terms:

variation, data, spread, statistical question, variability

Additional Resources:

- Lesson: [Statistical questioning](#)
- Lesson: [Statistical question sort](#)
- Lesson: [Grade 6 mathematics module 6, topic A, lesson 1](#)

Statistics and Probability

Develop understanding of statistical variability.

26 Understand that a set of data collected to answer a statistical question has a distribution which can be described by its center, spread, and overall shape.

Guiding Question with Connections to Mathematical Practices:

How can the distribution of a data set be described?

M.P.7. Look for and make use of structure. Interpret the distribution of data in terms of its center, spread, and overall shape. For example, describe a dot plot of exam scores as being skewed left, skewed right, or symmetric. Additionally, identify clusters, peaks, and gaps in a distribution and recognize how these affect the distribution's center and spread.

- Ask students to create dot plots that show different distributions. Each student should select skewed left, skewed right, or symmetric. Also, each student should select at least one other criterion, such as having clusters of data, peaks, or gaps in their distribution. For example, a student may decide to create a distribution that is skewed right and has two peaks. A sample student response is shown.

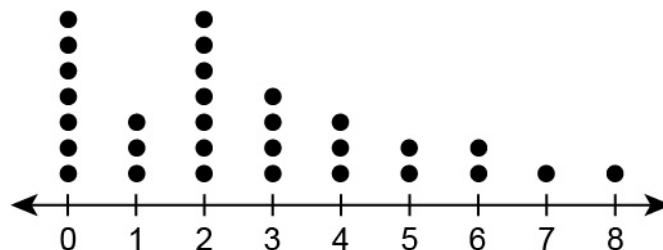

After each student has created a dot plot, ask students to exchange dot plots. Each student should then identify whether their given dot plot shows a distribution that is skewed left, skewed right, or symmetric. Each student should also identify any other terms that describe the distribution shown on the dot plot they were given.

- To illustrate symmetry in data distributions, provide students with part of a symmetric data set. The partial data set could be presented as a list, a set, or a dot plot, as shown. The center of the data set should be clearly indicated. For example, tell students that the center of a data set is 7 and that some of the data is shown in the following dot plot.

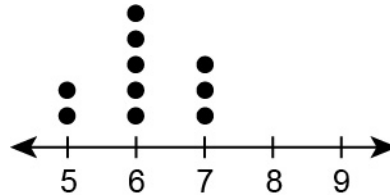

Ask students to complete the data set based on the data set’s symmetry and the given center. The completed data set for this example is shown below.

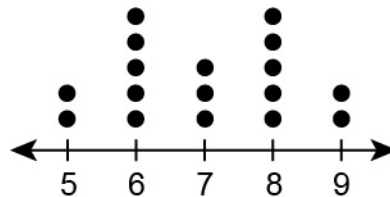

- Provide students with a histogram. For example, the histogram shown represents the number of videos watched on a video website by 50 different people in the last week.

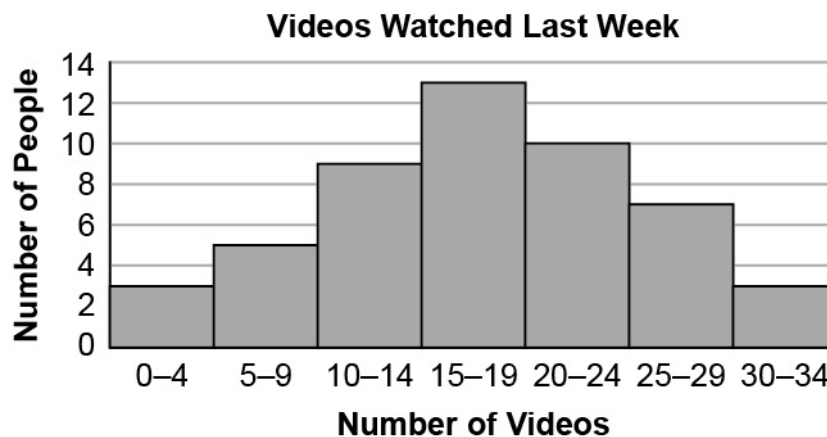

Ask students to identify terms that describe the data distribution. For this example, students might identify the distribution as roughly symmetric with a single peak and no gaps. Ask students to identify and ask questions about the limitations of describing the data set when the data set is presented as a histogram. Possible questions include:

- Could there be a gap between 15 and 19 where there are no student responses?
- Could the data set actually have multiple peaks?
- Could the data set actually be skewed right or left instead of roughly symmetric?

Students should recognize that some information about the data set is lost when using a histogram. For example, of the 13 respondents that watched between 15 and 19 videos, it is possible that 7 of them watched 15 videos and 6 of them watched 19 videos. This hypothetical set of responses would mean there actually is a gap in the data set at 16, 17, and 18 videos, although that gap is not visible in the histogram. Such a distribution would also create multiple peaks in the data set that are not visible in the histogram. However, the overall shape of the data set is most likely still roughly symmetric; it is not possible for most of the responses to actually be in the 5–9 range, for example. Ask students to also discuss the limitations of other forms of data presentation, such as box plots.

Key Academic Terms:

distribution, frequency, center, spread, shape, skew, symmetric, cluster, peak, gap

Additional Resources:

- Lesson: [What does the data tell us? Describing data](#)
- Lesson: [Shape, center, and spread](#)
- Lesson: [Grade 6 mathematics module 6, topic A, lesson 2](#)
- Lesson: [Grade 6 mathematics module 6, topic A, lesson 3](#)
- Lesson: [Grade 6 mathematics module 6, topic A, lesson 4](#)
- Lesson: [Grade 6 mathematics module 6, topic A, overview](#)
- Lesson: [Centers, spreads, and outliers](#)

Statistics and Probability

Develop understanding of statistical variability.

27 Recognize that a measure of center for a numerical data set summarizes all of its values with a single number, while a measure of variation describes how its values vary with a single number.

Guiding Questions with Connections to Mathematical Practices:**What does the mean of a data set represent?**

M.P.2. Reason abstractly and quantitatively. Understand that the mean is a measure of center that represents the equal distribution of the data, in the sense of unit rate, that can be calculated by finding the sum of all items in a data set divided by the number of items in the data set. For example, the number of books a group of students read during spring break can be represented by the data set {2, 3, 4, 5, 5, 6, 7, 8}. The mean of this data set equals $\frac{40}{8}$, or 5, and represents how many books each student would have read if they had all read the same number of books. Additionally, changes made to the values in a data set affect the mean, although the amount of the change in the mean is determined both by the specific changes as well as the number of values in the data set.

- Ask students to identify and determine the two key values necessary to calculate the mean of a data set: the sum of the values in the data set and the number of values in the data set. This example data set represents the ages of 6 randomly selected students at a summer camp.

$$\{12, 12, 13, 13, 14, 16\}$$

The two key values are 80 (the value of $12 + 12 + 13 + 13 + 14 + 16$) and 6 (the number of values in the data set). Ask students to use those key values to determine the mean. Here, the mean is $80 \div 6 = 13\frac{1}{3}$.

- Ask students to discuss how changing a single value in a data set or introducing a new value in a data set can affect the mean. The example data shown represents the number of photographs each of 5 participants displayed at an art show.

$$\{3, 4, 6, 7, 10\}$$

First, have students determine the mean of the data set. In this case, the mean equals $\frac{30}{5}$, or 6. Have students double the greatest value in the set and predict the new mean before calculating it. Then, have students remove the greatest value in the set and predict the new mean before calculating it.

- Ask students to interpret the mean in the context of a situation. For example, this data set represents the number of oranges in each of 6 crates.

$$\{8, 10, 10, 11, 13, 14\}$$

Ask students to determine the mean. In this case, the mean is 11. Ask students to interpret the mean in the context of oranges in crates. Students should identify that if the oranges were distributed equally among all the crates, each crate would contain the mean number of oranges, which is 11.

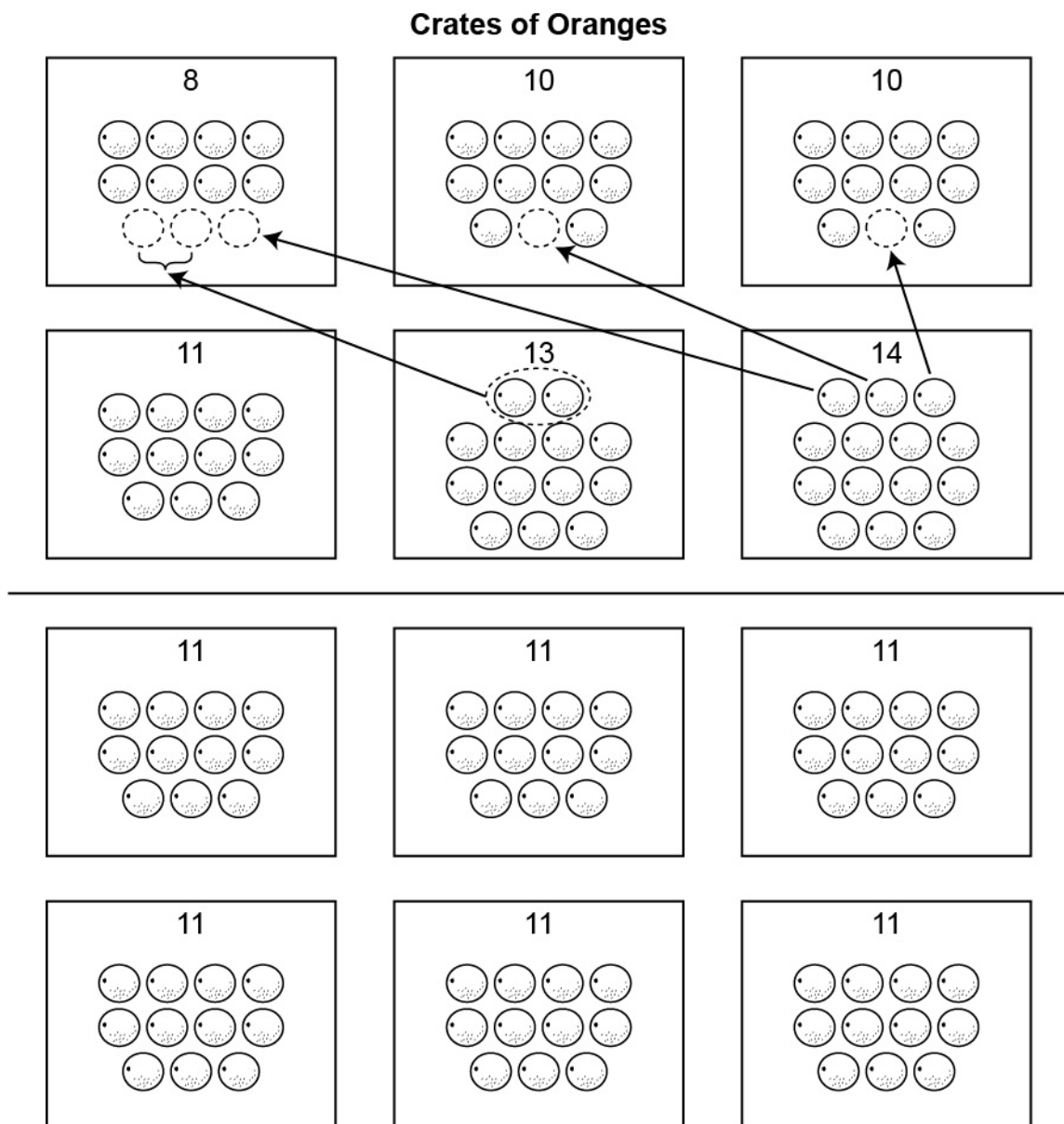

What does the median of a data set represent?

M.P.2. Reason abstractly and quantitatively. Understand that the median is a measure of center that represents the middle value of a data set that is in numerical order (or the mean of the two middle values with an even number of items). For example, a group of seven students were asked to roll a number cube until they get a 1 and to count the number of rolls. The data set {8, 9, 6, 1, 17, 2, 5} represents the number of rolls it took each of the students to get a 1. The median of this data set can be determined by rearranging the data into numerical order, which is {1, 2, 5, 6, 8, 9, 17}, and identifying that 6 is the middle value. The same number of students took more than 6 rolls as the number of students who took less than 6 rolls. Additionally, understand that the median may or may not be an actual value in the data set.

- To find the median of a data set with an odd number of items, ask students to arrange the values in a data set in numerical order, count the number of items in the data set, and find the middle value. For example, the data set shown represents the number of books each of 9 patrons checked out on their last visit to a library.

$$\{1, 3, 9, 3, 7, 2, 6, 12, 7\}$$

When that data set is ordered numerically, it is {1, 2, 3, 3, 6, 7, 7, 9, 12}. The set has 9 values and the middle value is 6, so 6 is the median. Note that the same number of patrons checked out fewer than 6 books as the number of patrons who checked out greater than 6 books. (If the median is not a repeated value in the set, there will always be the same number of values on either side of the median.) When there is an odd number of values in a data set, the median must be a value in the data set.

- To find the median of a data set with an even number of items, ask students to arrange the values in a data set in numerical order, count the number of items in the data set, and find the mean of the two middle values. For example, the data set shown represents the number of US states each of 10 students have visited.

$$\{2, 1, 2, 6, 1, 5, 9, 3, 2, 3\}$$

When that data set is ordered numerically, it is {1, 1, 2, 2, 2, 3, 3, 5, 6, 9}. The two values in the middle of the data set are 2 and 3. The mean of those values is $\frac{(2+3)}{2} = 2.5$, so the median of the data set is 2.5. The same number of students have visited fewer than 2.5 US states as the number of students who have visited more than 2.5 US states. When there is an even number of values in a data set, the median may be a value in the data set, but it does not have to be. As is the case here, since it is not possible to visit 2.5 states.

- To understand the effects of outliers on the median of data sets, ask students to find the median of a given data set and then change the maximum or minimum value to an extreme outlier and recalculate the median. This example shows the number of games of chess each of 6 students in a chess club played over the weekend.

$$\{2, 2, 3, 5, 6, 8\}$$

The median of the data set is 4, which is the mean of 3 and 5. If the student who played 8 games of chess over the weekend instead played 20 games of chess over the weekend, the median remains unchanged because it is only affected by the middle two values when the values are arranged in numerical order. Because the median only takes into account the central values, changes that do not affect those values have no effect on the median. The set can contain gaps and clusters and be skewed left or right, yet the median will not illustrate any of these characteristics.

What does the range of a data set represent and how is it different from measures of center?

M.P.2. Reason abstractly and quantitatively. Understand that, unlike measures of center, the range indicates variability within a data set by accounting for the difference between the greatest value and the least value. For example, consider the following data sets that represent the number of baskets scored by Molly and Kim over a five-game period. The number of baskets Molly scored were $\{10, 12, 12, 12, 14\}$, and the number of baskets Kim scored were $\{4, 8, 12, 16, 20\}$. Both data sets have a mean of 12; however, the number of baskets Kim scored in a game has more variability than the number of baskets Molly scored in a game because the range for Kim is 4 times as great as the range for Molly. Additionally, the range is unaffected by values that are not the extremes of a data set.

- To find the range of a data set, ask students to identify the greatest and least values. Then, ask students to find the difference between those two values. This data set shows the number of text messages each of 8 students received on Monday.

$$\{24, 11, 4, 7, 19, 3, 15, 7\}$$

The greatest value in the data set is 24. The least value in the data set is 3. Therefore, the range of the data set is $24 - 3 = 21$. Visually, the range of a data set represents the width of the data set on a horizontal number line. The values of the data set all lie within the interval from 3 to 24, which has a width of 21 units.

- Ask students to determine what effect changing values has on the range of a data set. For example, the data set shown represents the number of hawks spotted by a bird watcher each day for a week.

$$\{3, 1, 7, 6, 9, 2, 2\}$$

Ask students to calculate the range. (For this sample data set, the range is $9 - 1 = 8$.) Then, ask students what effect changing individual data values would have on the range. Because the range only takes into account the greatest and least values, changes that do not affect those values would have no effect on the range. The set can contain gaps and clusters and be skewed left or right, yet the range will not illustrate any of these characteristics.

What does the interquartile range of a data set represent?

M.P.2. Reason abstractly and quantitatively. Understand that interquartile range is the distance between the first and third quartiles of a data set and is a measure of variability. Consider again the data set generated by the students rolling a number cube until they got a 1: $\{1, 2, 5, 6, 8, 9, 17\}$. The first quartile is 2 and the third quartile is 9, so the interquartile range of this data set would be $9 - 2 = 7$. This means that the middle 50% of the data can be found between 2 and 9 with an interquartile range of 7. Additionally, understand that the term “interquartile range” describes the difference between the first and third quartiles.

- Ask students to find the interquartile range of a data set by using the following steps:
 1. Order the data from least to greatest.
 2. Determine the median.
 3. Determine the median of both the upper and lower halves of the data.
 4. Subtract the median of the lower half of the data from the median of the upper half of the data.

For example, the data set shown represents the number of student absences in a class for 9 days.

$$\{0, 3, 5, 2, 0, 1, 4, 3, 1\}$$

The ordered data set is $\{0, 0, 1, 1, 2, 3, 3, 4, 5\}$. The median is 2, which separates the data into two halves, each containing 4 values. The median of the lower half, $\{0, 0, 1, 1\}$, is $\frac{(0+1)}{2} = 0.5$. The median of the upper half, $\{3, 3, 4, 5\}$, is $\frac{(3+4)}{2} = 3.5$. This means that roughly 50% of the data lies between 0.5 and 3.5. The interquartile range is $3.5 - 0.5 = 3$.

- Ask students to discuss how changing various values in the data set may or may not affect the interquartile range. Have students experiment with changing the extremes of the data set, as well as the median or, in a set with an even number of data values, the two values in the middle of the data set that determine the median. Changing the minimum or the maximum or the values that determine the median generally does not affect the interquartile range, except in the cases of very small data sets or when the extremes are repeated data values. Because the interquartile range is only affected by certain values, changes that do not affect those values have no effect on the interquartile range. The set can contain gaps and clusters and be skewed left or right, yet the interquartile range will not illustrate any of these characteristics.

Key Academic Terms:

mean, median, mode, range, quartile, interquartile range (IQR), measure of center, measure of variation, outlier, data set

Additional Resources:

- Lesson: [Grade 6 mathematics module 6, topic B, overview](#)
- Lesson: [Centers, spreads, and outliers](#)

Statistics and Probability

Summarize and describe distributions.

28 Display numerical data in plots on a number line, including dot plots, histograms, and box plots.**Guiding Questions with Connections to Mathematical Practices:****What does the term “frequency” indicate and how can it be represented?**

M.P.5. Use appropriate tools strategically. Understand that the frequency of a specific data value refers to the number of times it occurs within a data set and that such information can be organized and displayed on a dot plot or histogram. For example, a gardener counted the number of flower buds on 7 rosebushes he was growing and recorded the information in the following list: {1, 2, 3, 3, 1, 2, 2}. The frequency for each number of flower buds can be represented with a dot plot in which dots are placed over points on a number line to represent that there are two rosebushes with 1 flower bud, three rosebushes with 2 flower buds, and two rosebushes with 3 flower buds. Additionally, any value not in the data set has a frequency of 0.

- Ask students to construct a dot plot that shows the frequency of a data set. The sample data set shown represents the number of times each of 10 students had a haircut in the last 6 months.

$$\{0, 3, 3, 2, 2, 0, 1, 2, 2, 2\}$$

Suggest strategies to make sure students do not miss recording any data when creating their dot plot. Some strategies might include:

- arranging the data in numerical order,
- crossing off each value in the set as it is plotted, and
- counting the total number of dots and comparing it to the total number of values in the data set.

The dot plot shown displays the sample data set.

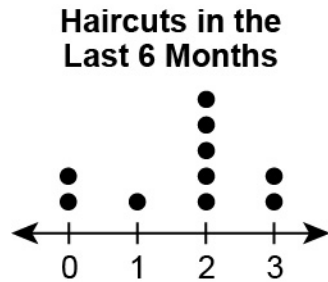

- Ask students to recreate a data set that is represented by a given dot plot. The following dot plot shows the number of students at each of 8 swimming classes Maria taught.

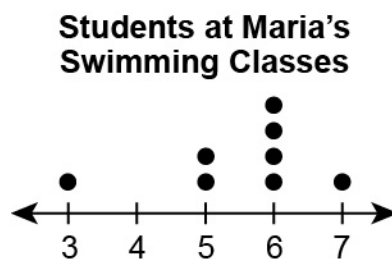

Students should create the data set $\{3, 5, 5, 6, 6, 6, 6, 7\}$, although the values in the data set can be listed in any order. Ask students questions about the data set. Along with each question, ask students whether the dot plot or the set of values is more useful for answering the question, or whether each representation of the data set is equally useful. Sample questions, with answers in parentheses, include:

- What is the frequency of the value 6 in Maria's data set? (4)
- What is the value (or values), greater than 0, with the least frequency? (3 and 7)
- Are there values with a frequency of 0? (any number except 3, 5, 6, and 7)

For the last question, students should observe that 4 is not the *only* value with a frequency of 0. The value of 4 is the one most apparent by the dot plot, but other values, such as 2 and 8, also have a frequency of 0.

- Ask students to determine the mean of a data set that is represented by a given dot plot. Students could determine the mean by recreating the original data set represented by the dot plot. The following dot plot shows the number of tigers at each of five zoos.

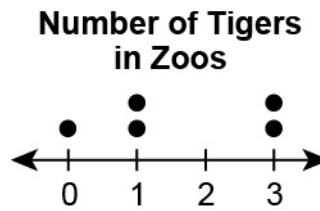

The underlying data set of the dot plot is $\{0, 1, 1, 3, 3\}$, and the mean is 1.6.

- Ask students to determine the median of a data set that is represented by a given dot plot. In addition to recreating the original data set, students could determine the median solely from the plot. The following plot shows the ages of children on a youth baseball team.

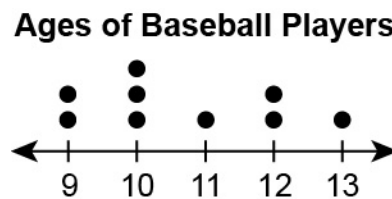

Since the data set has 9 values, the middle value is the fifth value in the data set. The first column of the dot plot (9) encompasses the first two values. The second column of the dot plot (10) encompasses the third, fourth, and fifth values. Therefore, the median value is 10.

What is a histogram and how does it show frequency differently than a dot plot?

M.P.5. Use appropriate tools strategically. Understand that while a dot plot displays the frequency of each individual value in a data set, a histogram uses a bar to display values within equal intervals. For example, when displaying the ages of attendees at a fair, a histogram might display the data values within the intervals 0 to 9, 10 to 19, 20 to 29, 30 to 39, and so on, instead of displaying data for each individual age within those intervals. Additionally, understand that because a histogram does not display individual values, it is not possible to calculate some other statistical measures (mean, median, mode), although a range of possible values can be calculated for some statistical measures.

- Ask students to construct a histogram from a given data set. The following data set shows the grade level of each of twelve students acting in a community play.

{1, 3, 7, 7, 8, 8, 9, 9, 10, 10, 11, 12}

Students should discuss what is reasonable for possible ranges for the histogram, provided that the ranges have the same span and the ranges take into account the minimum and maximum for the data set. For example, if one of the ranges is 3–8, then each range should cover six possible grade levels. The larger the span of each range, the less useful the histogram is likely to be. The smaller the span of each range, the more useful the histogram is likely to be; however, as the number of ranges increases, the histogram may become more difficult to read. In the example, because the data covers students from first grade through twelfth grade, using ranges of 1–4, 5–8, and 9–12 is probably the most reasonable. These ranges also roughly correspond with elementary, middle, and high school, which might be information the histogram is trying to convey. The histogram shown represents the example data set.

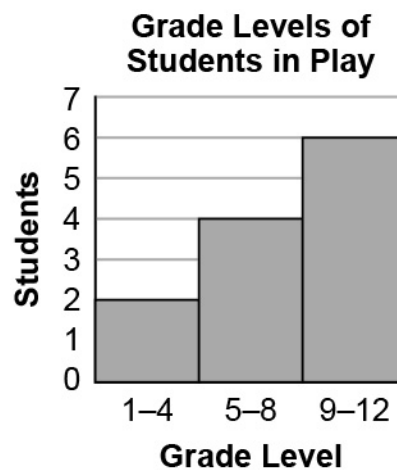

- Ask students to recreate a data set that could be represented by a given histogram. The example histogram shows the number of times per week that people floss their teeth.

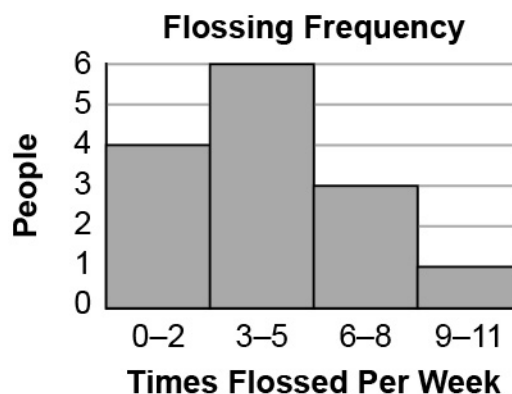

The first bar indicates that there are four data values in the 0–2 range. Students could choose any combination of four values from that range. Likewise, the second bar indicates that there are six values in the 3–5 range. Student could choose any combination of six values in the 3–5 range, three values in the 6–8 range, and one value in the 9–11 range. One possible data set is {0, 0, 2, 2, 3, 3, 3, 4, 4, 5, 7, 7, 7, 11}. Once students have created their data sets, ask them to compare their data sets.

- Ask students to determine a range for the mean of a data set represented by a given histogram. The following histogram shows the number of letters in each of 25 students' last names.

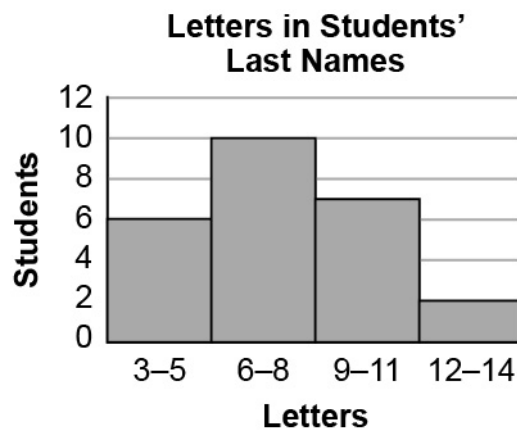

To find the least possible value for the mean, students should identify the least possible value in each range presented in the histogram and then assume all members of the data set in that range have the least possible value. In the example histogram, students can start by assuming all 6 data values in the 3–5 range have a value of 3; all 10 data values in the 6–8 range have a value of 6; and so on.

- Here, the least possible mean is:

$$[(3 \times 6) + (6 \times 10) + (9 \times 7) + (12 \times 2)] \div 25 = 6.6.$$
- Likewise, the greatest possible mean is:

$$[(5 \times 6) + (8 \times 10) + (11 \times 7) + (14 \times 2)] \div 25 = 8.6.$$

Therefore, the mean must be somewhere between 6.6 and 8.6.

- Ask students to determine a range for the median of a data set represented by a given histogram. Using the same histogram as before, have students identify which value is the middle value, since the set has an odd number of values. In the example set, the thirteenth value is the middle one, since 12 values in the set must be less than or equal to it and 12 values in the set must be greater than or equal to it. The first range in the histogram (3–5) encompasses 6 values, and the next range (6–8) encompasses 10 values, so the 6–8 range must encompass the 13th value in the data set. Therefore, the median must lie in the 6–8 range. Furthermore, because there is an odd number of values in the data set, the median must be 6, 7, or 8. If there were an even number of values in the data set, then the median could also be 6.5 or 7.5, in the cases where the middle two values were 6 and 7 or 7 and 8, respectively.

What is a box plot and how does it represent data?

M.P.5. Use appropriate tools strategically. Interpret the range, median, interquartile range, first and third quartiles, and outliers as a box plot for a data set. For example, the number of times students rolled a number cube until they got a 1 is {1, 2, 5, 6, 8, 9, 17}. The median of this data set is 6, the first quartile is 2, and the third quartile is 9. To construct a box plot for this data set, draw a number line from 1 to 17, mark the median and quartiles above the number line, and make a box to show the interquartile range from 2 to 9. Finish the box plot by drawing the range as lines that go down to the minimum, 1, and up to the maximum, 17. Additionally, understand that box plots are useful for identifying some key values in a data set and for visually representing variation, but at the expense of obscuring other measures of center, such as the mean, and measures of variation that rely on the mean, such as mean absolute deviation.

- Ask students to construct a box plot from a given data set. The following data set shows the number of keys on the key rings of each of ten teachers.

$$\{2, 3, 3, 4, 4, 5, 7, 7, 8, 9\}$$

Ask students to identify the 5 values needed to make a box plot. The median of the data is the mean of 4 and 5, which is 4.5. This divides the data set into two halves. The median of the lower half is 3, which is the 1st quartile. The median of the upper half is 7, which is the 3rd quartile. The minimum value is 2 and the maximum value is 9. Ask students to use those 5 values to construct a box plot. The box plot for the example data set is shown.

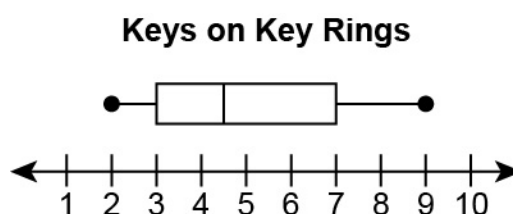

- Ask students to recreate a data set that could be represented by a given box plot. The example box plot shows the number of junk emails each of 11 people received yesterday.

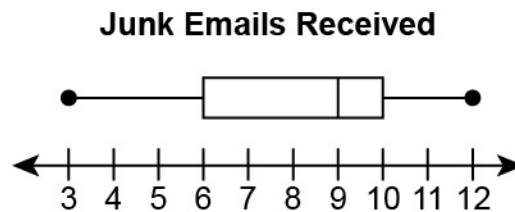

Because there are 11 data points in the set, the median must be the middle value, so 9 must be in the data set. The median divides the data set into two halves, each containing 5 values. Since each half contains 5 values, the 1st and 3rd quartiles must also be in the data set, so the data set includes 6 and 10. Finally, the minimum and maximum must be in the data set. Based on the box plot, students should determine that the data set contains {3, 6, 9, 10, 12}. Students should fill in the remaining values; a sample data set might be {3, 4, 6, 7, 7, 9, 9, 10, 10, 11, 12}.

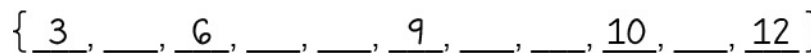
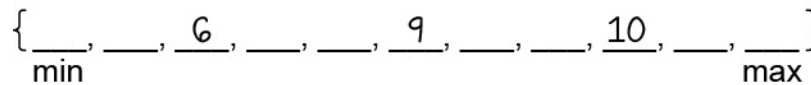
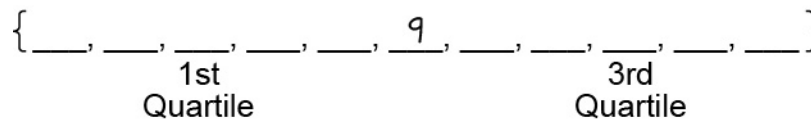
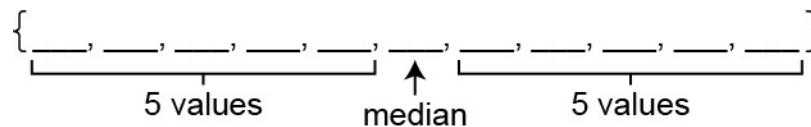

Once students have created their data sets, ask them to compare their data sets.

- Ask students to determine a range for the mean of a data set represented by a given box plot. Using the same “Junk Emails Received” box plot, have students identify which values are definitely in the box plot and which values can be chosen. The median, first and third quartiles, maximum, and minimum are definitely in the box plot. The remaining six values can be chosen. Students should find the least possible mean of the data set by assuming all six adjustable values are as small as possible. For this box plot, the data set with the smallest mean is {3, 3, 6, 6, 6, 9, 9, 9, 10, 10, 12} and it has a mean value of about 7.55. Likewise, the data set with the greatest mean is {3, 6, 6, 9, 9, 9, 10, 10, 10, 12, 12} and it has a mean value of about 8.73.

Key Academic Terms:

variation, data, spread, statistical question, frequency, dot plot, histogram, box plot, outlier, range, minimum, maximum

Additional Resources:

- Lesson: [Shape, center, and spread](#)
- Lesson: [Grade 6 mathematics module 6, topic D, overview](#)

Statistics and Probability
Summarize and describe distributions.
29 Summarize numerical data sets in relation to their context, such as by:
29a Reporting the number of observations.

Guiding Questions with Connections to Mathematical Practices:

How can the total number of observations in a data set be determined?

M.P.6. Attend to precision. Identify how data is organized and accounted for in dot plots, frequency tables, and histograms. For example, if a data set includes 10 total observations, then a dot plot or frequency table representing the data will include exactly 10 dots or 10 tally marks. Additionally, make the distinction between the subject being observed and the trait about that subject that is being measured.

- Ask students to determine the number of observations given a frequency table. The following example shows the number of words each person in a spelling contest spelled correctly.

Words Spelled Correctly

Words	Students
16	2
17	5
18	9
19	11
20	3

For this frequency table, each observation represents a particular student, so the total number of observations is the total number of students. In this case, that is $2 + 5 + 9 + 11 + 3 = 30$. Ask students to distinguish between the subjects being observed (in this case, students) and the trait about those subjects (in this case, the words spelled correctly).

- Ask students to determine the number of observations given a histogram. The following histogram shows the number of videos uploaded to a website by a random selection of its users.

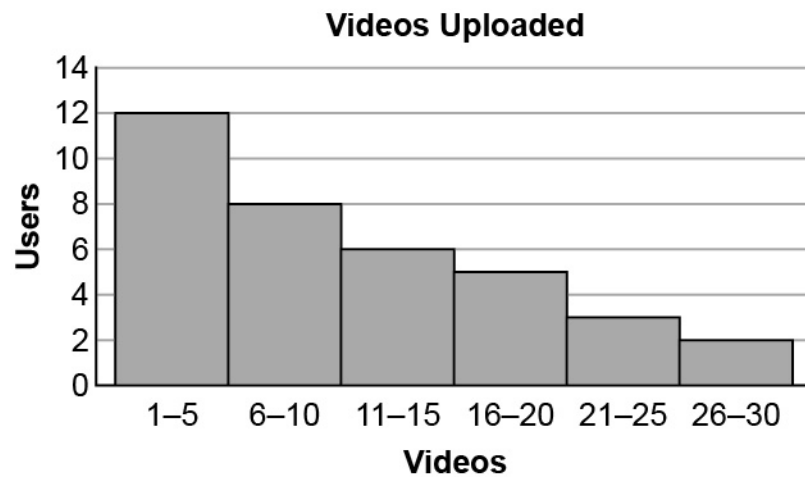

While the histogram does obscure the specific data values (for instance, it is impossible to tell how many users uploaded exactly 5 videos), it does not obscure the total number of observations. The total number of observations is the sum of the heights of each of the bars. In this example, the total number of observations is $12 + 8 + 6 + 5 + 3 + 2 = 36$. Here, the subjects being observed are the website's users, and the trait about those subjects is the number of videos uploaded.

Why is the number of observations important when interpreting a data set in context?

M.P.1. Make sense of problems and persevere in solving them. Explain that the number of observations provides insight into the appropriateness of the size of the data set for a context and is needed to make comparisons within the data set. For example, a data set that is meant to represent the heights of all 6th graders in a large middle school would not be appropriate if it only included the heights of 5 students. Additionally, explain why having a greater number of observations will almost always give more accurate data.

- Ask students to write a survey question for which there could be a large range of numeric answers from their classmates. Possible survey questions include:
 - How many letters are in your last name?
 - How many cousins do you have?
 - What is the age of the oldest child in your household?

Then, ask students to give their survey question to five of their classmates and calculate the mean of the data set from these responses. Students should continue to survey additional classmates one or two at a time. After each response, the asking student can recalculate the mean. Students should continue until they reach a total of approximately 20–25 data values. Students should observe that the mean changes rapidly at the beginning of the process, when the number of observations is low. As the number of observations increases, the mean stabilizes towards the mean value for the entire class.

- Ask students to come up with populations for which various numbers of observations would be appropriate for a survey question. For example, if the entire population of interest is the math teachers at the students' school, 5 observations might be an appropriate sample size. However, if the population of interest is all the teachers at the students' school, 5 observations might not be appropriate; depending on the school size, a larger sample size, such as 15 or 20, might be more appropriate. Likewise, if the population of interest is the school's entire student population, the sample size might need to be increased to 100.

Key Academic Terms:

observations, data set, dot plots, frequency tables, histograms

Additional Resources:

- Lesson: [Grade 6 mathematics module 6, topic D, overview](#)
- Lesson: [Introducing the concept](#)

Statistics and Probability

Summarize and describe distributions.

29 Summarize numerical data sets in relation to their context, such as by:**29b** Describing the nature of the attribute under investigation, including how it was measured and its units of measurement.**Guiding Question with Connections to Mathematical Practices:****How do the context and units of measurement of collected data affect the summary and display of numerical data?**

M.P.6. Attend to precision. Recognize that an accurate summary of data requires consistency and precision when collecting the data. For example, if a researcher wants to display the water depths of lakes in a county, then he or she must measure the depths with a consistent unit and under similar conditions (e.g., the same time of year) every time. Additionally, understand that a data display must include the units of measure in order to be meaningful.

- Ask students to describe things they would measure or observe for which the measurement could change based on the time of day or time of year. Examples include:
 - the number of cricket chirps per hour,
 - the number of children at a playground, and
 - the weight of apples on an apple tree.

Ask students to explain how the measurements might change based on the time of day or time of year, and discuss how those changes might affect which conclusions would or would not be valid conclusions to draw from the data. For example, measuring the number of children at a playground at different times of day or different times of the year would be useful for estimating the number of visitors all the playgrounds in a town have on a yearly basis. However, those same measurements would not be helpful for predicting which individual playgrounds get the most visitors. Comparing the number of children at a playground in the summer with the number of children at another playground in the winter would not be a meaningful comparison. When measurements are not consistently taken, the results may lack meaning in some contexts.

- Ask students to draw conclusions and calculate measures of center and spread based on a data display in which the units are not included, such as the example dot plot shown.

Weight of Watermelons on August 31

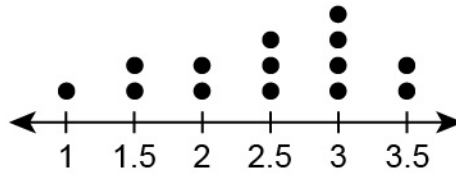

Even though the data for the example dot plot was collected under similar conditions (i.e., on August 31), the lack of inclusion of a consistent unit makes statistical measures less useful. For example, while the mean can be determined to be approximately 2.46, this value has little meaning without a unit of measure. In this case, both pounds and kilograms are likely possibilities.

Key Academic Terms:

data, attribute, unit of measurement

Additional Resources:

- Activity: [Dunk tank!: mean, median, mode & range](#)
- Lesson: [Grade 6 mathematics module 6, topic D, overview](#)

Statistics and Probability

Summarize and describe distributions.

29 Summarize numerical data sets in relation to their context, such as by:

29c Giving quantitative measures of center (median and/or mean) and variability (interquartile range and/or mean absolute deviation) as well as describing any overall pattern and any striking deviations from the overall pattern with reference to the context in which the data were gathered.

Guiding Questions with Connections to Mathematical Practices:

What does an outlier represent and how can it affect measures of center or variability?

M.P.4. Model with mathematics. Recognize that an outlier refers to a value that is inconsistent with the data set because it is either much greater or much less than the other values in the data set and that such values can cause some measures of center or variability to be unrepresentative. Use context to determine the importance of the outlier. For example, if the prices of 6 bikes on a rack are {\$85, \$90, \$105, \$110, \$120, \$360}, then the value \$360 is an outlier because it is a much higher price than all other values and skews the mean so much that it no longer represents the other values. Additionally, recognize that outliers typically have less of an effect on the median than on the mean.

- Ask students to identify outliers in listed data sets such as the set described previously as well as in data displays. For example, the dot plot shows the number of hours each of 10 employees at a store worked last week.

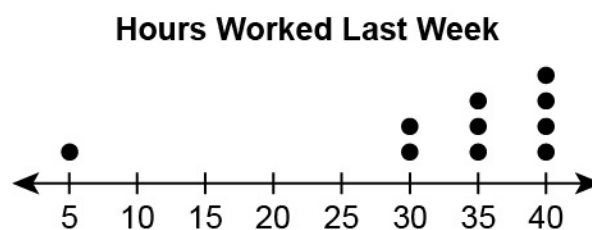

The value 5 is an outlier because it is much lower than all the other values.

- Ask students to calculate measures of center and measures of variability given a data set with an outlier, and then compare those values to the respective values of the data set when the outlier is removed. In the data set represented by the dot plot shown, the mean is 33, the median is 35, and the range is 35. After removing the outlier of 5, the mean is approximately 36.1, the median remains at 35, and the range is 10. If the outlier were even more extreme (for example, if the employee represented that worked only 5 hours last week instead worked 0 hours last week), the mean would be affected even more, while the median would remain unchanged. The farther the outlier is from the rest of the data set, the greater the effect it has on the mean and range.

What are quartiles and how do they divide data?

M.P.4. Model with mathematics. Understand that quartiles represent three values, including the median, that are used to divide a set of data into fourths. For example, if seven people are asked how long they have had their current car, the data set may consist of the values {2, 4, 6, 8, 10, 10, 14}. The three quartiles are 4 years (first quartile), 8 years (median), and 10 years (third quartile). Additionally, understand that quartiles, like the median, may or may not be actual values in the data set, depending on the number of values in the data set.

- Ask students to find the quartiles of a data set given the data set. The following data set shows the number of books each of thirteen people currently have checked out from a public library.

$$\{1, 1, 2, 3, 4, 4, 5, 6, 6, 8, 10, 11, 13\}$$

To find the quartiles, students start by counting the number of values and arranging the values in increasing order. Students then find the middle value. For the data set shown, because there are thirteen values, the seventh value, 5, is the median. Students find the first quartile by finding the median of the lower half of the data set, {1, 1, 2, 3, 4, 4}. Since there is an even number of values in this part of the data set, the first quartile is the mean of the two middle values, 2 and 3, which is 2.5. Likewise, students find the third quartile by finding the median of the upper half of the data set, {6, 6, 8, 10, 11, 13}. The third quartile is the mean of the two middle values of the upper half, 8 and 10. Therefore, the third quartile is 9. Ask students to look at how the quartiles and the median divide the data set.

$$\{1, 1, 2\}, \{3, 4, 4\}, \{6, 6, 8\}, \{10, 11, 13\}$$

Observe that the quartiles and the median section the data approximately into fourths. Each section of the data has approximately 25% of the data points.

- Ask students to find the quartiles of a data set given a dot plot. The following dot plot shows the number of flights with late arrivals at a small airport on each of 25 days.

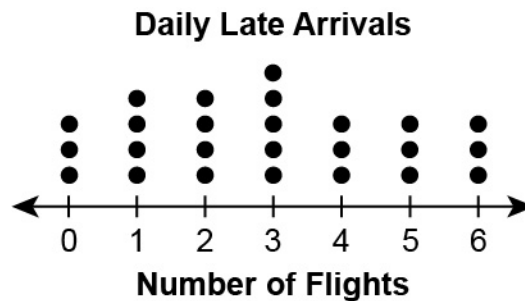

Because there are 25 values in the data set, the median will be the thirteenth data point, which can be found by counting from either end of the dot plot. The median number of flights with late arrivals per day is 3. Each half of the data set contains 12 values. For each of these halves, the median will be the mean of the sixth and seventh values in the data set. For the lower half, students should find the median by counting from the left end of the dot plot to find the sixth and seventh values, which are 1 and 1, so the first quartile is 1. For the upper half, students should find the median by counting from the right end of the dot plot to find the sixth and seventh values, which are 5 and 4, respectively, so the third quartile is 4.5.

What is the interquartile range and how does it differ from the range?

M.P.2. Reason abstractly and quantitatively. Recognize that while the range indicates variability within a data set by accounting for the difference between the greatest value and the smallest value, the interquartile range indicates variability within a data set by accounting for the difference between the third (upper) quartile and the first (lower) quartile. Often, the interquartile range helps to summarize the measure of spread better than the range because it is less affected by outliers than the range. For example, if seven people are asked how many years they have had their current car, the data set may consist of the values {2, 4, 6, 8, 10, 10, 14}; the range equals 12, while the interquartile range equals 6. Additionally, understand how changes in values in a data set do or do not affect the interquartile range.

- Ask students to calculate the interquartile range of a given data set. The following data set shows the number of questions each of 12 teams answered correctly in a trivia contest.

$$\{5, 7, 8, 11, 13, 14, 16, 16, 17, 19, 20, 22\}$$

To find the interquartile range, students should start by finding the first and third quartiles. For this data set, the first quartile is the mean of 8 and 11, which is 9.5, and the third quartile is the mean of 17 and 19, which is 18. Then, to find the interquartile range, subtract the first quartile from the third quartile. The interquartile range in this case is $18 - 9.5 = 8.5$.

- Ask students to change values in a data set and determine the effect, if any, the changes have on the range and the interquartile range. Guide the students' investigations by challenging them to make changes to their data and create new data sets that have:
 - the same interquartile range as the original data set, but a different range,
 - a larger interquartile range than the original data set, but a smaller range,
 - both the same interquartile range and the same range as the original data set, but is a different set of data, and
 - a range that is the same as its interquartile range.
- Ask students to compare the range and interquartile range of a data set with outliers. The following data set shows the total number of raffle tickets sold by each of 10 students.

$$\{1, 10, 12, 12, 14, 15, 17, 20, 22, 78\}$$

Have students determine the range by subtracting the least value in the data set from the greatest. For the example data set, the range is $78 - 1 = 77$. Then, have students determine the interquartile range by first determining the upper and lower quartiles and then finding the difference. For the example data set, the interquartile range is $20 - 12 = 8$. Have students discuss which measure (range or interquartile range) is more representative of the data in the set. For the example data set, the interquartile range is more representative of the data in the set because of the outlier of 78.

What is the mean absolute deviation of a data set and how does it differ from the mean?

M.P.4. Model with mathematics. Recognize that while the mean is a measure of center, the mean absolute deviation is a measure of variation that indicates the mean amount that the data differ from the mean of the data. For example, the data set $\{4, 4, 6, 8, 8, 12, 14\}$ represents the ages in years of children at a restaurant on one occasion. The mean age of the children is 8 years, while the mean absolute deviation of the ages is approximately 2.86, which indicates that, on average, each child's age is within 2.86 years of 8. Additionally, recognize that the mean absolute deviation depends solely on the distance each value is from the mean and remains the same for data sets with the same distributions. For example, the mean absolute deviations of $\{1, 3, 4, 8\}$ and $\{11, 13, 14, 18\}$ are equal to one another.

- Ask students to calculate the mean absolute deviation of a given data set. The following data set shows the number of sandwiches sold by a sandwich shop from noon to 1:00 p.m. for 10 consecutive days.

$$\{6, 7, 7, 8, 9, 9, 10, 11, 12, 14\}$$

Have students first calculate the mean. For the data set shown, the mean is 9.3. Then, have students calculate the distance from each value in the set to the mean. For example, the first value in the data set, 6, is 3.3 units from the mean. Have students find the mean of the 10 distances, which is the mean absolute deviation. In this case, the mean absolute deviation is 1.96.

- Ask students to calculate the mean absolute deviation of two given data sets presented as dot plots. For example, the first dot plot shown represents the data set about sandwiches given previously. The second dot plot represents the same information but for a different sandwich shop.

Sandwiches Sold by First Sandwich Shop

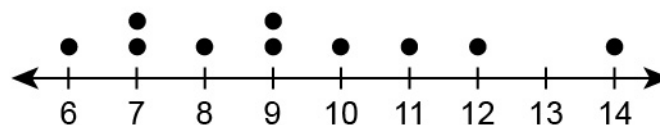

Sandwiches Sold by Second Sandwich Shop

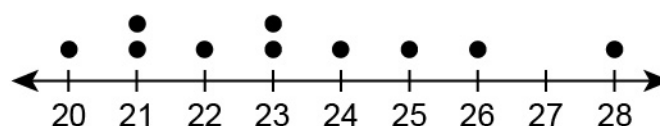

While the mean is different for each data set (the mean for the second data set is 23.3), the mean absolute deviation is the same for each data set because they have the same distribution. Students should recognize that it is the distance from the mean, not the actual values in the set nor the actual value of the mean, that is relevant for determining the mean absolute deviation.

- Create a number line on the floor using masking tape and ask students to model data sets by standing at the points in the data set. For example, illustrate the data set $\{1, 2, 5, 9, 13\}$ by asking a student to stand at each of those points on the number line. Ask each student to count how many steps away they are from the mean value of 6. Record each student's response, then calculate the mean of the responses. This calculates the mean absolute deviation to be 4. Then, ask students to model another data set that has the same mean, but a different mean absolute deviation. For example, illustrate the data set $\{4, 5, 6, 7, 8\}$. Ask each student to count how many steps away they are from the mean value of 6, record each response, and then calculate the mean of the responses to get a mean absolute deviation of 1.2. Ask students to describe how crowded they were when modeling each data set and how that relates to the mean absolute deviation.
- Ask students to examine the term “mean absolute deviation” word by word.
 - The word “deviation” means “to differ from.”
 - The word “absolute” refers to absolute value, which is a reminder that mean absolute deviation depends on the distance between two values and that distance is always positive.
 - The word “mean” refers to the value from which the distance is calculated.

Students should recognize that the term “mean absolute deviation” functions almost as a set of instructions for how to find it.

Key Academic Terms:

measure of center, measure of variability, mean, median, interquartile range (IQR), outlier, mean absolute deviation

Additional Resources:

- Lesson: [Centers, spreads, and outliers](#)
- Activity: [Line plot representation of deviation from the mean](#)
- Activity: [Dunk tank!: mean, median, mode & range](#)
- Video: [Mean absolute deviation](#)

Statistics and Probability

Summarize and describe distributions.

29 Summarize numerical data sets in relation to their context, such as by:**29d** Relating the choice of measures of center and variability to the shape of the data distribution and the context in which the data were gathered.**Guiding Questions with Connections to Mathematical Practices:****When does the mean provide the best summary of data?**

M.P.3. Construct viable arguments and critique the reasoning of others. Recognize that the mean is appropriate for data that are roughly symmetric. For example, the mean is an appropriate measure of center for the data set representing the number of hits a baseball player had over an eight-game stretch, {2, 3, 1, 4, 3, 1, 3, 2}, because there are no outliers or clear skew. Additionally, recognize that outliers can have an extreme effect on the mean of a data set.

- Ask students to calculate the mean for a data set with and without an outlier. The example data set shows the number of visitors to a museum on each of the first 6 days of the week.

$$\{94, 101, 78, 80, 95, 92\}$$

Calculate the mean for the data set, which is 90. Students should then include an additional value in the data set that is an outlier. For the given example, suppose that admission to the museum on the seventh day is free and, as a result, the museum has 601 visitors on the seventh day. Students should calculate the mean of the new data set, including the outlier. In this case, the mean of the new data set is 163. This mean is much larger than the majority of values in the data set and it would be misleading to use this number to describe the average daily museum attendance.

- Ask students to examine a data set and indicate whether or not the mean is an appropriate measure of center. The example dot plot shows the length of time, rounded to the nearest minute, that it took each of 15 students to bicycle from their homes to a local park.

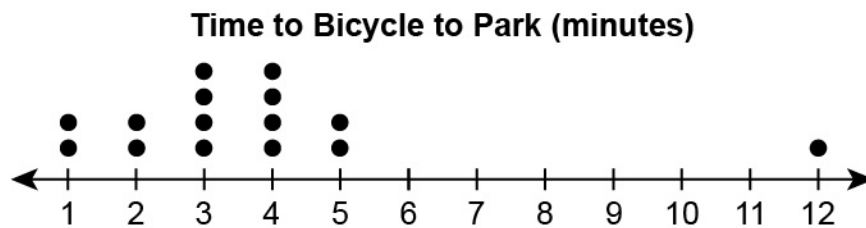

In this data set, the mean is not an appropriate measure of center because the data set contains an outlier. This can be determined without actually calculating the mean.

When does the median provide the best summary of data?

M.P.3. Construct viable arguments and critique the reasoning of others. Recognize that the median is appropriate for data that are very asymmetric. For example, the median is an appropriate measure of center for the data set representing the number of letters or characters found in 7 different languages, {26, 28, 24, 33, 29, 21, 3000}, because the mean is significantly affected by the outlier of 3000. Additionally, recognize that changing the extreme data values in the set has no effect on the median.

- Ask students to calculate the median of a data set and then change the value of the outlier. Observe that the median does not change. The example data set shows the number of pages in each of 10 best-selling books.

{185, 199, 220, 235, 240, 255, 290, 301, 302, 988}

Calculate the median; for the example data set, the median is the mean of 240 and 255, which is 247.5. When the outlier of 988 is changed, as long as it remains greater than 255, the value of the median does not change; it will still be the mean of the two middle values, which remain 240 and 255.

- Ask students to calculate the mean and median of a data set with clustering and then decide which is more representative of the data set. The example data set shows the ages of 18 people at a movie theater that is showing a children’s movie.

$$\{4, 4, 5, 5, 5, 5, 6, 6, 7, 7, 7, 10, 10, 24, 30, 33, 34, 44\}$$

The mean of the example data set is $13\frac{2}{3}$. The median of the example data set is the average of the middle values, which is 7. For this data set, the median is more representative due to the strong asymmetric skew. The mean would give the misleading impression that the movie being shown is more of a teen movie than a children’s movie.

- Given a variety of data sets, ask students to calculate both the mean and median and determine whether one measure provides the best summary of the data or whether the two measures are equally representative. The example data set shows the number of employees that each of 9 companies located in a particular city has.

$$\{99, 125, 140, 155, 210, 240, 310, 345, 392\}$$

The mean of the data set is 224. The median of the data set is the middle value, 210. The data set does not contain any clustering nor any outliers, so the mean and the median are equally representative.

How do context and the shape of a data distribution help determine the measure of variability to use to describe a data set?

M.P.3. Construct viable arguments and critique the reasoning of others. Use context and the shape of a data distribution to determine the measure of variability to describe a data set. For example, if the data set has extreme outliers, it makes sense to use the median for the measure of center because it is less sensitive to extreme values, and therefore it also makes sense to use the interquartile range for the measure of variability. Additionally, understand that for some data sets, multiple measures of variability and measures of center might all be equally representative of the data.

- Ask students to determine the most appropriate measure of variability and measure of center for a given data set. Whether the range or the interquartile range is a more appropriate measure of variability depends, in part, on the purpose of the data. When taking into account the extreme values is important, then the range may be a more appropriate measure. When it is important to consider a larger portion of the data set, then the interquartile range may be a more appropriate measure. The example dot plot shows the number of cars waiting at an intersection at a specific time each hour for 12 hours.

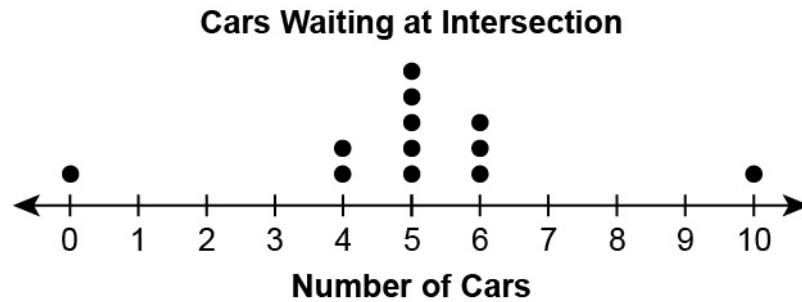

If the data is being used to program a map application about typical traffic flow, the interquartile range is more appropriate. The purpose of the data is to get a general estimate of the travel time that will be correct most of the time. On the other hand, if the data is being used to estimate the maximum travel time between destinations, then the range may be a more appropriate measure of variability in this case because the extreme values, however rare they may be, are still important to take into account.

- Considering the conditions under which data in a data set were collected, ask students to discuss which measure of variability and which measure of center is likely to be the most representative of the data set. For example, given a data set of wind speeds all taken from the same place each minute for 15 minutes, students could expect there to be few outliers and expect that the data will be generally clustered. Therefore, the range and the interquartile range are likely to be equally representative of the data set's variability. Likewise, the mean and the median are likely to be equally representative of the data set's center. Discuss what changes might affect the answers. In the example given, if there were infrequent wind gusts during the data collection period, the resulting data may have an outlier, which would generally mean that the range would become less representative of the data set's variability and the mean would become less representative of the data set's center.

Key Academic Terms:

measure of center, measure of variability, mean, median, mode, outlier

Additional Resources:

- Lesson: [Grade 6 mathematics module 6, topic C, overview](#)
- Lesson: [Shape, center, and spread](#)
- Activity: [Dunk tank!: mean, median, mode & range](#)

*This page is
intentionally left
blank.*

Copyright © 2020 by the Alabama State Department of Education. The materials contained in this publication may be duplicated by Alabama educators for local classroom use. This permission does not extend to the duplication of materials for commercial use.

Alabama Educator Instructional Supports: ACAP Summative Survey

Please take a few minutes to answer 10 survey questions by April 30, 2021. You may complete the survey electronically here: <https://www.surveymonkey.com/r/WXZWXCT>. If you prefer to mail in your survey, you may print this page and mail it in an envelope using the address on the next page. You may also print this double-sided with the following page, fold it into thirds, seal it with tape, and mail it. The survey takes approximately five minutes to complete.

1. Which content area(s) did you use? (Check all that apply.)

- English Language Arts Mathematics Science

2. Which grade(s) did you use? (Check all that apply.)

- 2 3 4 5 6 7 8

3. In which state district (such as Leeds City or Winston County) do you work? _____

4. What is your current position/job title?

- Classroom teacher
- Curriculum coach/specialist (school or district)
- Teacher assistant/classroom aide/paraprofessional
- Administrator
- Other (please specify): _____

5. For how many standards did you use the material in the Instructional Supports when planning your instruction?

- All Most Some None

6. How helpful were the Instructional Supports in providing a deeper understanding of the standards?

- Very helpful Helpful Somewhat helpful Not helpful

7. How helpful were these documents to you when planning instruction?

- Very helpful Helpful Somewhat helpful Not helpful

8. How many times did you consult the Instructional Supports documents while planning instruction?

- Daily A few times a week A few times a month A few times during the school year One or two times Zero times

9. How likely are you to recommend the use of the Instructional Supports to other teachers in your district or school?

- Very likely Somewhat likely Somewhat unlikely Very unlikely

10. Is there any additional information about the Instructional Supports that you would like to share or any additional resources that you would like to see included?

Thank you for taking the time to fill out the survey.

(fold here)

Place stamp
here. Postal
service will not
accept without
a stamp.

Data Recognition Corporation
Attn: Alabama Instructional Supports Feedback
2800 Northwest Boulevard
Plymouth, MN 55441

(fold here)