

MARINE CORPS DRILL AND CEREMONIES MANUAL

PART I: DRILL

CHAPTER 7

NATIONAL AND ORGANIZATIONAL FLAGS

	<u>PARAGRAPH</u>	<u>PAGE</u>
GENERAL	7000	7-5
COLOR SALUTES	7001	7-7
HOISTING, LOWERING, AND FOLDING THE NATIONAL ENSIGN	7002	7-7
SALUTES AND HONORS TO THE NATIONAL FLAG	7003	7-12
COMPOSITION OF THE COLOR GUARD	7004	7-13
SYNCHRONIZING THE MANUAL OF ARMS FOR THE COLOR GUARDS ARMED WITH RIFLES	7005	7-18

SECTION 1: MANUAL OF THE COLORS

ORDER COLORS	7100	7-25
CARRY COLORS FROM ORDER COLORS	7101	7-26
ORDER COLORS FROM CARRY COLORS	7102	7-28
PRESENT COLORS FROM ORDER COLORS	7103	7-31
SALUTES BY THE ORGANIZATIONAL COLORS	7104	7-32
ORDER COLORS FROM PRESENT COLORS	7105	7-33
PRESENT COLORS FROM CARRY COLORS	7106	7-33
CARRY COLORS FROM PRESENT COLORS	7107	7-33
RESTS WITH THE COLORS	7108	7-33
EYES RIGHT (LEFT) FROM CARRY OR ORDER COLORS	7109	7-35
CARRY OR ORDER COLORS FROM EYES RIGHT (LEFT)	7110	7-36
TRAIL ARMS WITH THE COLORS	7111	7-37

SECTION 2: MOVEMENTS OF THE COLOR GUARD

FACE THE COLOR GUARD TO THE RIGHT (LEFT).	7200	7-39
FACE THE COLOR GUARD TO THE REAR	7201	7-40

MARINE CORPS DRILL AND CEREMONIES MANUAL

	<u>PARAGRAPH</u>	<u>PAGE</u>
MOVEMENTS UTILIZED BY JOINT COLOR GUARDS (JCG)	7202	7-41
RIGHT (LEFT) WHEEL	7203	7-41
LEFT ABOUT	7204	7-42

SECTION 3: COLOR GUARD PROTOCOL

GENERAL	7300	7-43
RECEIVING THE COLORS BY THE COLOR GUARD	7301	7-43
RECEIVING THE COLORS BY THE COLOR COMPANY (BATTALION)	7302	7-44
DISMISSING THE COLOR GUARD	7303	7-45
RETURNING THE COLORS BY THE COLOR GUARD	7304	7-45
CASING AND UNCASING THE COLORS	7305	7-45
TROOPING THE COLORS	7306	7-47
INDOOR CEREMONIES INVOLVING COLOR GUARDS	7307	7-48
ORDERING COLORS, STAFFS AND OTHER CEREMONIAL GARRISON PROPERTY	7308	7-52

FIGURE

7-1	DIFFERENT TYPES AND NOMENCLATURE OF ENSIGNS	7-8
7-2	POSITION OF NATIONAL ENSIGN AT HALF-MAST	7-9
7-3	FOLDING THE ENSIGN	7-11
7-4	COLOR GUARD COMPOSITION	7-14
7-5	THE COLOR STAFF	7-17
7-6	CARRY COLORS TO ORDER COLORS	7-18
7-7	CARRY COLORS TO PRESENT COLOR	7-20
7-8	PRESENT COLORS TO CARRY COLORS	7-22
7-9	ORDER COLORS	7-25
7-10	CARRY COLORS FROM ORDER COLORS	7-26
7-11	ORDER COLORS FROM CARRY COLORS	7-28

MARINE CORPS DRILL AND CEREMONIES MANUAL

	<u>PAGE</u>
7-12	PRESENT COLORS FROM ORDER COLORS 7-31
7-13	SALUTES BY THE ORGANIZATIONAL COLORS 7-32
7-14	COLOR GUARD AT PARADE REST 7-34
7-15a	EYES RIGHT, HALTED 7-35
7-15b	EYES RIGHT, MARCHING 7-36
7-16	MARCHING AT TRAIL COLORS 7-37
7-17	RIGHT (LEFT) TURN 7-39
7-18	COUNTERMARCH 7-40
7-19	RIGHT (LEFT) WHEEL ABOUT 7-41
7-20	LEFT ABOUT 7-42
7-21	RECEIVING/RETURNING THE COLORS BY THE COLOR GUARD . . . 7-43
7-22	RECEIVING/RETURNING THE COLORS BY THE COLOR COMPANY . . 7-44
7-23	UNCASING AND CASING COLORS 7-46
7-24	TROOPING THE COLORS 7-48
7-25	POSTING AND RETRIEVING THE COLORS INDOORS 7-49
7-26	MARCH IN COLUMN OF TWOS AND REFORM 7-50
7-27	MARCH IN COLUMN OF ONES AND REFORM 7-50
7-28	POSTING AND RETRIEVING THE COLORS INDOORS (FLAG STANDS SEPARATED) 7-51

MARINE CORPS DRILL AND CEREMONIES MANUAL

SECTION I: DRILL

CHAPTER 7

NATIONAL AND ORGANIZATIONAL FLAGS

7000. GENERAL

1. When flown from ships or crafts of the Navy or from a flagstaff at commands ashore, the national flag will be displayed per the provisions of *U.S. Navy Regulations*. The national flag is also called the "national ensign" or "ensign."

2. Marine organizations are equipped with a national flag and an organizational flag. The organizational flag is an official flag that is authorized to be displayed by an organization of the U.S. Marine Corps.

3. When mounted on a staff (pike) and carried by an individual on foot, or displayed or cased in a fixed location, the national flag is called the "national colors" and the organizational flag is called the "organizational colors." The term "colors" means either or both the national colors and the organizational colors.

→ a. The use of the plural form of the word color (colors) to designate a single flag, ensign, standard, or pennant comes from the ancient tradition of referring to the multiple colors found on these types of standards. This tradition is carried on today when we refer to the national colors; red, white, and blue and the Marine Corps colors; scarlet and gold. The plural form is also used when referring to the types of movements, ceremonies or musical accompaniment involving the colors, i.e., carry colors, morning colors, "To the Color" etc.

b. When designating personnel or units as part of color details then the appropriate singular or plural form of the word will be used, i.e., color guard, color company, etc.

4. When mounted on a vehicle, the national flag is called the "national standard" and the organizational flag is called the "organizational standard." The term "standard" means the national standard only. The term "standards" means both the national standard and the organizational standard.

5. In garrison or on board ship, the colors of an organization, when not in use, are kept by the commanding officer. Whenever practicable, colors should be kept uncased and displayed in the office of the commanding officer, or other appropriate place. They may be cased, however, by placing them within a protective covering. Colors that are kept cased and not used often should be unfurled and aired frequently.

6. The colors (standards) may be carried in any formation in which two or more companies participate, and in escorts and honor guards when ordered. Separate companies and detachments, who are authorized organizational colors, may carry colors when two or more platoons participate. Unless otherwise directed for special ceremonies, the national colors will always be carried when the organizational colors are carried, but the national colors may be carried alone.

7. In battalion formations, the colors (standards) will be posted with a designated color company and in regimental formations with a designated color battalion. The color company (battalion) is posted in the formation so that the color guard is in the approximate center of the formation (right or forward of center if this is impossible).
8. In most regimental formations, only the colors (standards) of the regiment will be carried. When two or more separate battalions are formed as a regiment, only the colors (standards) of one battalion will be carried for the regiment. When authorized by the commander, however, the organizational colors of subordinate organizations may be carried in ranks (massed color guard) arranged behind the parent organization's color guard.
9. When the organizational colors are draped in mourning, the mourning streamer shall consist of a black crepe streamer 7 feet long and about 12 inches wide. A bowknot, the loops of which are 6 inches long, is tied in the center. This knot attaches the streamer to the upper ferrule, just below the spearhead. If a streamer attachment set is used, the bowknot will be tied on the upper ferrule below the streamer attachment set in a manner so as not to disturb the natural hang of the unit's battle streamers.
10. Uncased colors will be treated with dignity and formality. When moved while outdoors, they will be marched by a color guard. Whenever possible, they will be escorted by a color company (battalion) from the organizational headquarters to the place of the ceremony. If it becomes necessary to case or uncase the colors outdoors, it will be accomplished with proper ceremony as described in paragraph 7305.
- 11. Whenever the colors are brought forward of the line of troops (e.g., trooping the colors, for retirements, awards, etc.) the command must present arms. If a band or bugler is present and the colors are uncased, the appropriate music, e.g., "*National Anthem*," "*To the Color*," or "*Retreat*" will also be played
12. During training and rehearsals (except full dress rehearsals), colors will be cased.
13. Colors (standards) are never allowed to touch the deck.
14. Color guards do not fix bayonets.
15. The standard weapon used for the color guard is the M16A2 service rifle.
16. Those units, whose T/O ceremonial weapons are the M1 or M14 rifle, should refer to appendixes A and B for the manual of arms.
17. The use of gold fringe on the U.S. Flag is expressly forbidden for Marine Corps organizations.
18. The U.S. Flag, when displayed or carried on a staff (pike) is adorned with a red, white, and blue rope and tassel. The organizational color is adorned with a scarlet and gold rope and tassel. However, once a unit has been awarded a streamer the rope and tassel is removed from the organizational color and a streamer attachment set added between the upper ferrule and the spearhead. Ropes and tassels are affixed to the top of the staff between the two ribs of the upper ferrule using a girth hitch knot. (See figure 7-5.)

Enclosure (1)

19. The national and organizational colors are only destroyed when; they have become soiled beyond cleaning, torn beyond repair and to keep them from falling into enemy hands.
20. Flags that may have a historical significance are disposed of per the instructions contained in MCO P10520.3.
21. National and organizational colors will only be carried on wooden 9 1/2-foot flagstuffs. The use of metal flagstuffs is only authorized for Marine Barracks Washington, DC.
22. For further information concerning flags, streamers and guidons refer to MCO P10520.3.

7001. COLOR SALUTES

1. **By the National Colors (Standard).** The national colors (standard) renders no salute, except as specified in *U.S. Navy Regulations*, paragraph 1263.1.
- 2. **By the Organizational Colors.** In military ceremonies, the organizational colors salutes while the "*National Anthem*," "*To the Color*," "*Retreat*," or "*Hail to the Chief*" is being played, and when rendering honors to the organizational commander, individual of higher rank, or the dead, but in no other case. (See par. 7104.)
3. **By the Organizational Standard.** The organizational standard renders no salutes as it is mounted on a vehicle.

7002. HOISTING, LOWERING, AND FOLDING THE NATIONAL ENSIGN

1. General

- a. The ceremonial hoisting and lowering of the national ensign at 0800 and sunset, respectively, shall be accomplished ashore per the provisions of *U.S. Navy Regulations* and this paragraph.
- b. A detail consisting of a noncommissioned officer and two enlisted members of the guard will hoist and lower the ensign. This detail will be armed with sidearms, if the special equipment of the guard includes sidearms; otherwise, the pistol belt only will be worn.
- c. The commander of the guard ashore will see that the proper ensign is flown at the appropriate time and under all weather conditions. For different types of ensigns. (See figure 7-1.) Any member of the guard who observes any hazard to the ensign, such as loosened halyards, fouling, etc., will immediately report them to the commander of the guard.

2. **Positions of the Ensign.** The ensign is flown from the peak or truck of the mast, except when directed to be flown at half-mast. The ensign at half-mast is flown, when possible, with the middle point of its hoist opposite the middle point of the mast. The middle point of a guyed mast is midway between the peak of the mast and the point of attachment of the guys. The middle point of a mast with a yardarm is midway between the peak of the mast and the yardarm. Technically, an ensign at any position other than at the peak of the mast is half-mast. Local conditions may require other positions. To half-mast the ensign, it is first hoisted to the peak and then lowered to the half-mast position.

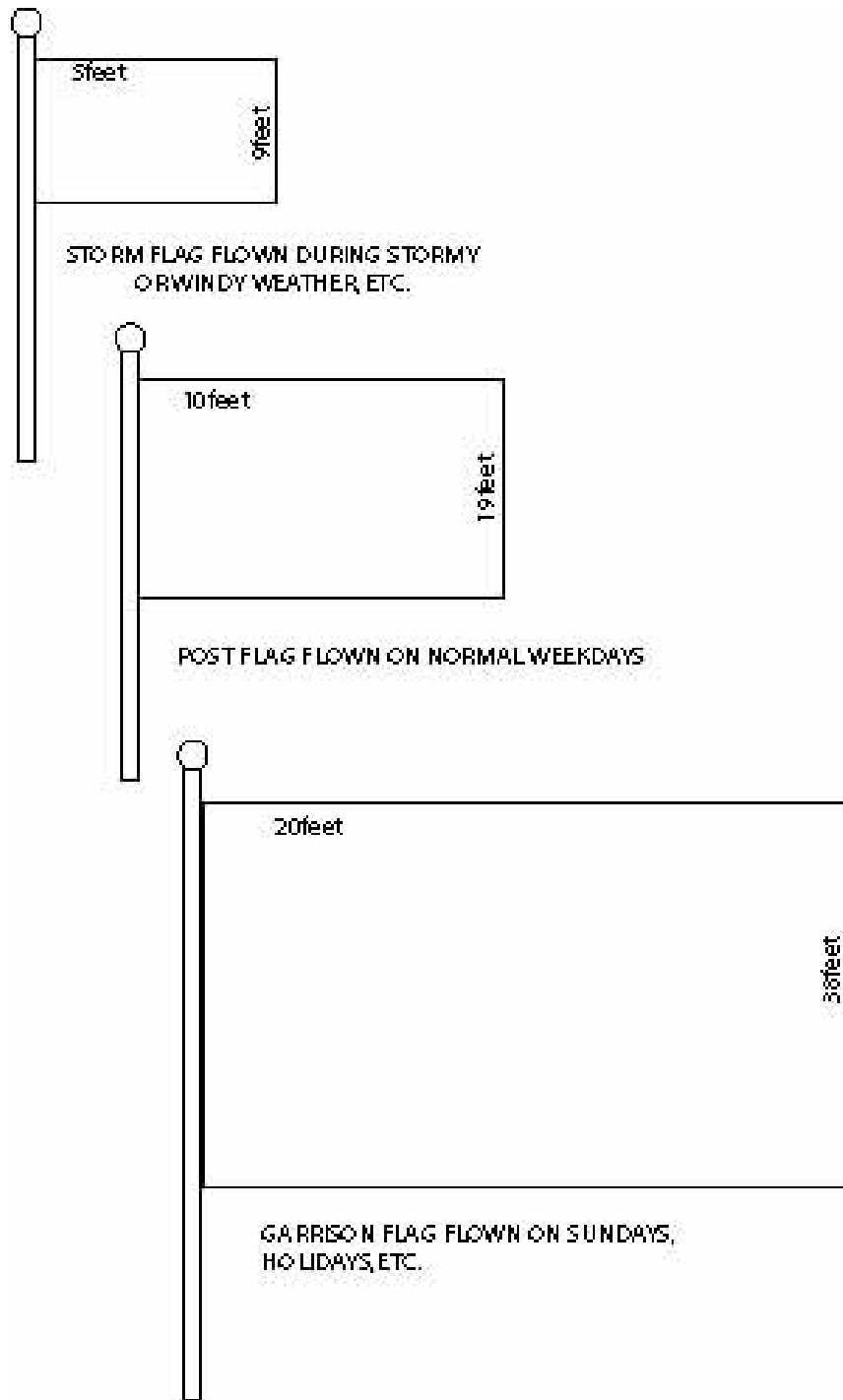

Figure 7-1.--Different Types and Nomenclature of Ensigns.

- 3. Hoisting the Ensign. The detail assigned to hoist the ensign is formed in line at the guardhouse with the noncommissioned officer carrying the folded ensign in the center. The detail is then marched to the flagstaff, halted, and the ensign attached to the halyards. The halyards are manned by the two enlisted members, who take positions on opposite sides of the staff, facing it, so they will be able to hoist the ensign without fouling it. The flag should be clearly marked so that the blue field is raised first. Additionally, the ensign should be pulled sufficiently, prior to the beginning of colors, to insure the blue field is hoisted first. This action precludes the embarrassment of hoisting the ensign upside down. The noncommissioned officer continues to hold the ensign until it is hoisted clear of his grasp to prevent it from touching the deck. When the ensign is clear, the noncommissioned officer executes a hand salute. After the ensign is hoisted, the other members of the detail grasp the halyard in their left hand and execute a hand salute. On the last note of the "*National Anthem*" or "*To the Color*," all members of the detail terminate their hand salutes. If the ensign is to be flown at half-mast, it is then lowered slowly to that position. (See figure 7-2.) The halyards are then secured to the cleat of the mast. The detail is again formed, marched to the guardhouse, and dismissed.

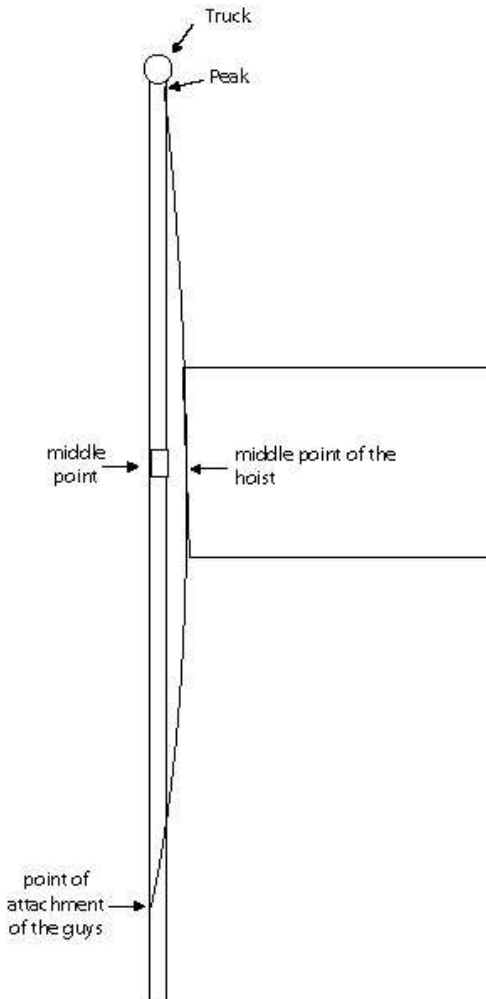

Figure 7-2.--Position of Mast.

National Ensign at Half-

4. Lowering the Ensign. The detail is formed at the guardhouse, marched to the flagstaff, and the halyards manned in the same manner as for hoisting the ensign. On the first note of the "*National Anthem*" or "*Retreat*," the ensign is slowly lowered. If at half-mast, it is first hoisted smartly to the peak on the first note of the music, and then slowly lowered. The noncommissioned officer catches it at the last note of the music. The ensign is detached from the halyards and folded as prescribed below. The halyards are secured to the mast; the detail is formed and marched to the guardhouse, where the ensign is turned over to the commander of the guard.

5. Replacing an Ensign Already Hoisted. There may be times when it is necessary to replace the ensign after morning colors but prior to evening colors. Some examples are, changing to a storm flag due to inclement weather; the ensign becomes fouled in the halyards; the ensign is raised upside down; etc.

a. If the flagstaff is double rigged, i.e., has two sets of halyards, the new ensign is hoisted to the peak or truck and then the ensign being replaced is slowly lowered, folded and returned to the guardhouse.

b. If the flagstaff has only one halyard, two color details are used to replace the ensign. The first color detail slowly lowers the ensign, and then quickly moves from the flagstaff to fold the old ensign. The second color detail, with the replacement ensign, then moves to the flagstaff and hoists the new ensign to the peak or truck. Both details salute as the replacement ensign is hoisted. Both color details then return to the guardhouse.

6. Folding the Ensign. The ensign is folded in half the long way so the crease parallels the red and white stripes. It is folded in half again so the new crease also parallels the red and white stripes with the blue field on the outside of the fold. The lower corner of the fly end (away from the blue field) is folded up to the top so the single (folded) edge lays perpendicular across the stripes. By repeatedly folding along the inboard edge of the triangle, the ensign is folded into the shape of a cocked hat. (See figure 7-3.)

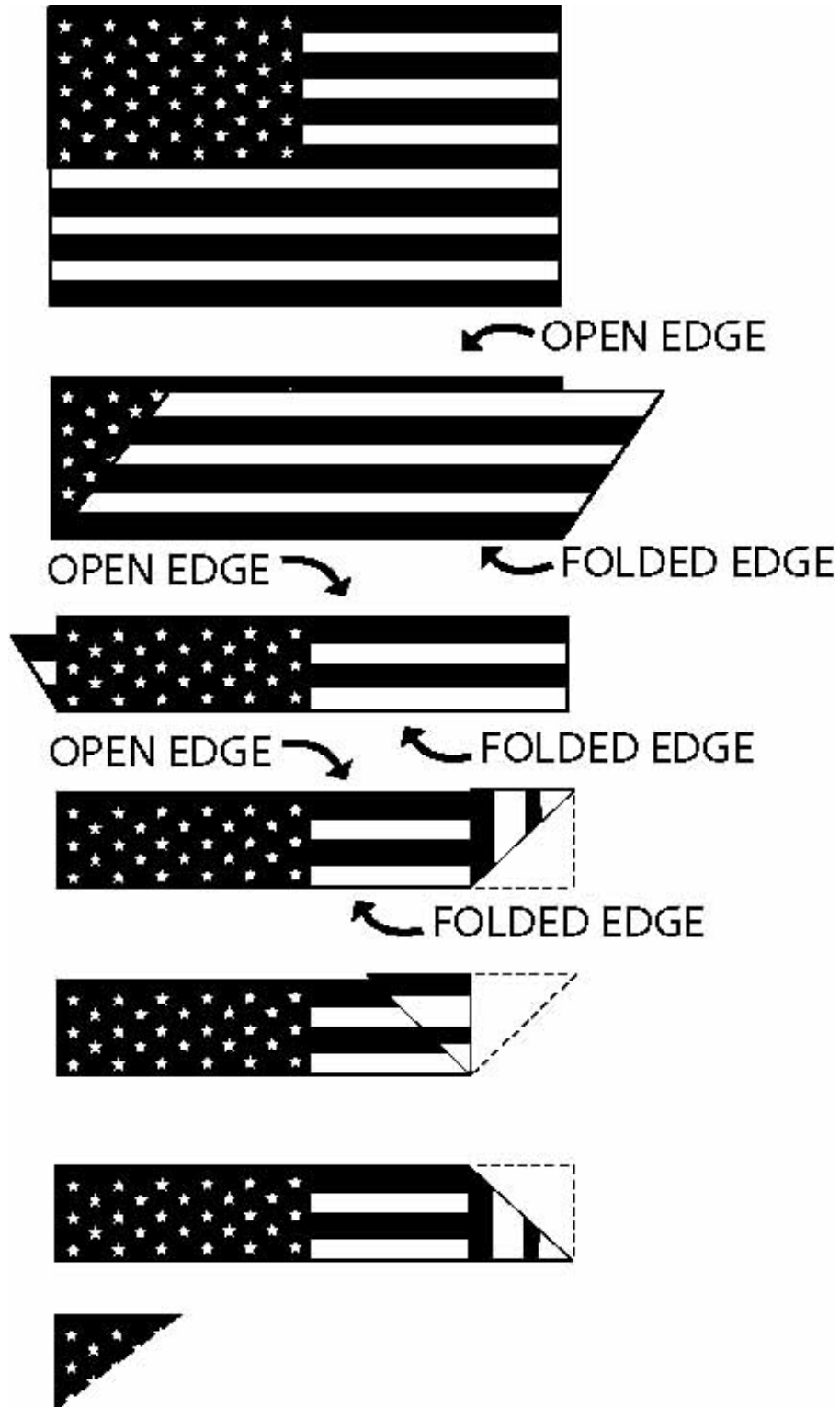

Figure 7-3.--Folding the Ensign.

7003. SALUTES AND HONORS TO THE NATIONAL FLAG

1. General. Salutes to the national flag are rendered per *U.S. Navy Regulations*. (See chapter 12, section 2.)

- 2. By Individuals. Individuals in the Navy, when in uniform and covered will render the appropriate salute (hand, rifle, etc.) as indicated below. Persons not in uniform will stand at attention, face the flag and place the right hand over the heart. Gentlemen, if covered, remove their headdress with the right hand and hold it at the left shoulder, so that the right hand is over the heart. When in full uniform indoors and uncovered, individuals will stand at attention.
- a. During morning colors and evening colors individuals stop and face the flagstaff, or in the direction of the music, when "Attention" is sounded. Salutes are rendered by individuals on the first note of the "National Anthem," "To The Color," or "Retreat," and terminated on the last note. Individuals would remain at attention facing the flagstaff/music until "Carry On" is sounded, and then continue about their duties.
- b. When being passed by or passing the national colors (standard) uncased.
- c. Small flags carried by individuals and flags flying from flagstaffs, either stands alone or affixed to a building, (except during morning and evening colors) are not saluted.
- d. A folded flag being carried to morning colors, or from evening colors, by a color detail is considered cased and not saluted.

3. By Persons in Formation

- a. During morning colors and evening colors the formation commander stops the formation and causes it to face the flagstaff, or in the direction of the music, when "Attention" is sounded. The formation commander salutes for the formation on the first note of the "National Anthem," "To The Color," or "Retreat," and terminate the salute on the last note. The formation is kept at attention facing the flagstaff/music until "Carry On" is sounded at which time the formation commander would move the formation to its destination or dismiss the formation.
- b. When being passed by or passing the national colors (standard) uncased, persons in formation are brought to attention and order arms if halted, or attention if marching. The formation commander shall render the salute for his unit, facing the colors if the formation is halted. Persons in formation participating in a ceremony shall, on command, follow the procedure prescribed for the ceremony.
- c. Small flags carried by individuals and flags flying from flagstaffs, either stands alone or affixed to a building, (except during morning and evening colors) are not saluted.
- d. A folded flag being carried to morning colors, or from evening colors, by a color detail is considered cased and not saluted.

Enclosure (1)

4. By Occupants of Vehicles. During morning colors or evening colors or when being passed by or passing an uncased national colors, all vehicles in motion will be brought to a halt. Persons riding in such vehicles shall remain seated at attention until colors are over or the color has passed.

7004. COMPOSITION OF THE COLOR GUARD

- 1. The standard Marine Corps color guard consists of four individuals of approximately equal height. Two noncommissioned officers are the color bearers and two other members, junior to the color bearers, are the color guards. The senior color bearer carries the national colors and commands the color guard. The junior color bearer carries the organizational colors, which is always on the left of the national colors. (See figure 7-4a.) If a female is part of the color guard she wears trousers, and not a skirt, for uniformity. When designating the uniform for the color guard, consideration should be given to the effect that the color bearers' slings may have on ribbons and badges. Slings are adjusted so that the colors are the same height when at the carry or, if this isn't possible, the national colors are slightly higher than the organizational colors. If necessary, have the senior color bearer slightly taller than the organizational color bearer. All members of the color guard wear the pistol belt (white belt if in blues); the color bearers wear the pistol belt over the sling to keep the sling firmly in place. If the color guard is wearing the service cover, then they use two chin-straps. One is worn normally and the second one is worn under the chin. When only the national colors is carried, the color guard will include only one color bearer.
2. Color guards carrying the Navy and Marine Corps service colors will consist of five members, three Marines and two Navy members. The national color bearer and commander of the color guard will be a Marine. (See figure 7-4b.)
3. A Joint Armed Forces Color Guard will consist of eight members; three Army, two Marine, one Navy, one Air Force, and one Coast Guard. The national color bearer and commander of a joint color guard will be a soldier. The respective service colors are aligned to the left of the national colors per DoD directives. (See figure 7-4c.) For color guards involving service academies, reserve or National Guard colors, refer to chapter 14, for the proper precedence.
4. Massed colors is when a regimental or larger unit commander desires to have all of that command's subordinate colors in the color guard. The first rank of massed colors consists of the two riflemen, the national colors and the colors of the senior unit present. This is the senior color guard. The remainder of the organizational colors form ranks of four behind the first rank, by seniority, from the color guards right to left. (See figure 7-4e.) Odd numbered colors are placed by seniority, and are filled in from right to left. (See figure 7-4d.) During parades and ceremonies when the colors are brought forward, only the first rank, senior color guard, marches forward. If colors are to be trooped, the senior color guard only is trooped. The remainder of the massed colors marches on with the unit to their position in the line of troops, leaving space for the senior color guard.
5. The national colors of foreign countries will not be carried by the same color guard carrying the United States colors. When necessary, a separate color guard, consisting of one noncommissioned officer and two enlisted, will be formed to carry foreign colors.
6. The flags or banners of non-U.S. military organizations (e.g., Boy Scouts, Kawanas Club, etc.) are not carried in the color guard.

Enclosure (1)

7. Color guards armed with rifles will be trained to execute a modified rifle manual. This involves pauses on the part of one or the other riflemen so that the rifles move to and from the right and left shoulders at the same time, as described in paragraph 7005.

8. The color guard is formed and marches in one rank at close interval with the color bearers in the center. While marching, members of the color guard do not swing their free arms. The color guard does not execute to the rear march, about face, flanking movements or fix bayonets. When the unit to which the color guard is attached executes any such commands, the senior color bearer orders a movement appropriate for the color guard.

9. The color bearers are unarmed, but the color guards carry either pistols or rifles (except when inside a chapel). Only color guards mounted on horseback carry the noncommissioned officer's sword vice a rifle or pistol. When participating in a ceremony inside a chapel, the color guard will be unarmed and uncovered.

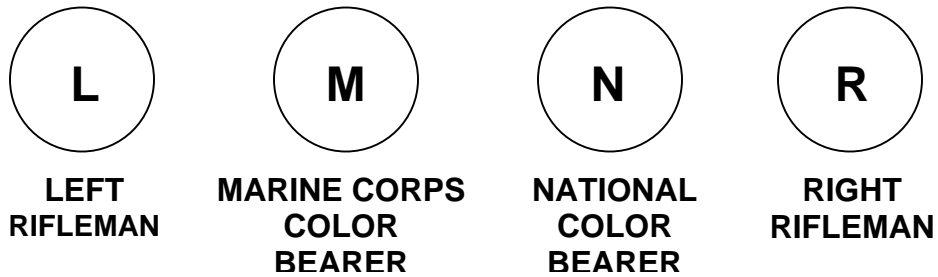

a. Marine Corps Color Guard.

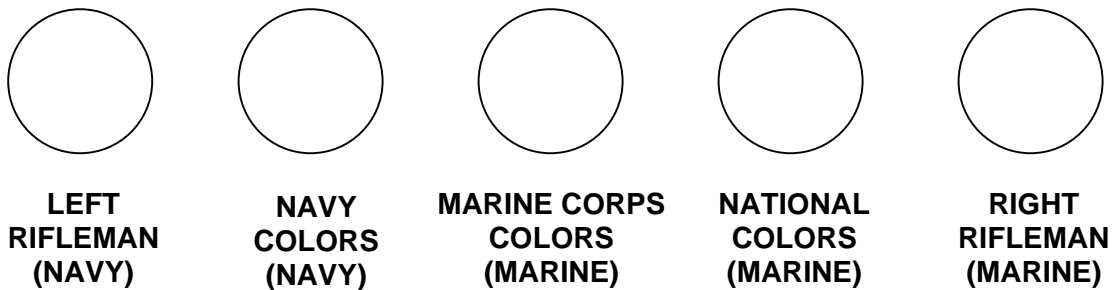

b. Navy and Marine Corps Color Guard.

Figure 7-4.--Color Guard Composition.

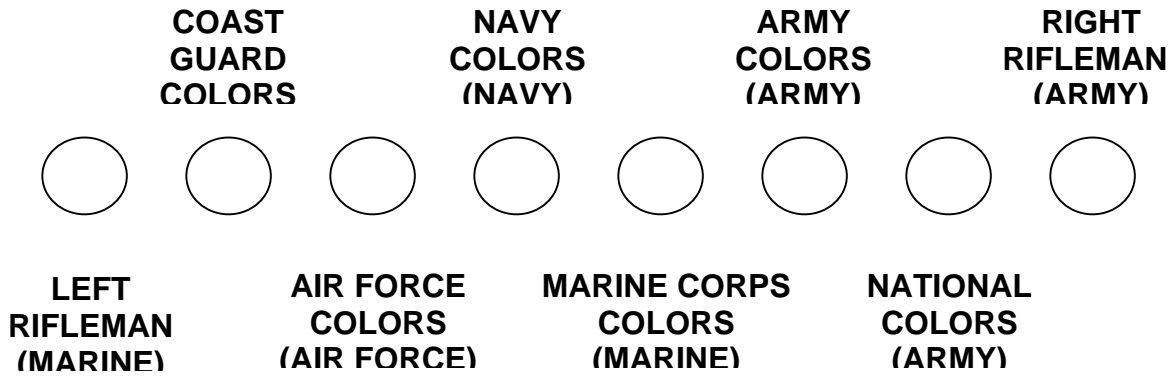

c. Joint Armed Services Color Guard.

INF REGT

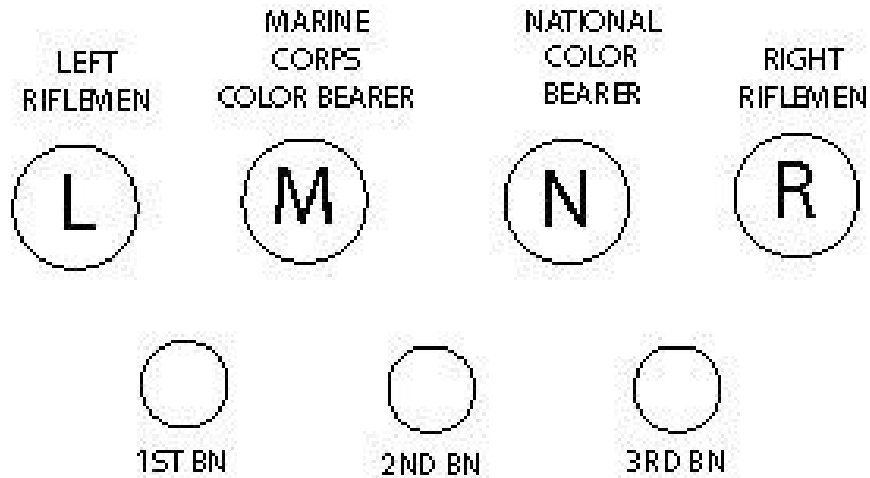

d. Placement of Odd Numbered Colors in a Massed Color Guard.
(Using a Marine Regiment as an example)

Figure 7-4.--Color Guard Composition--Continued.

Division Color Guard

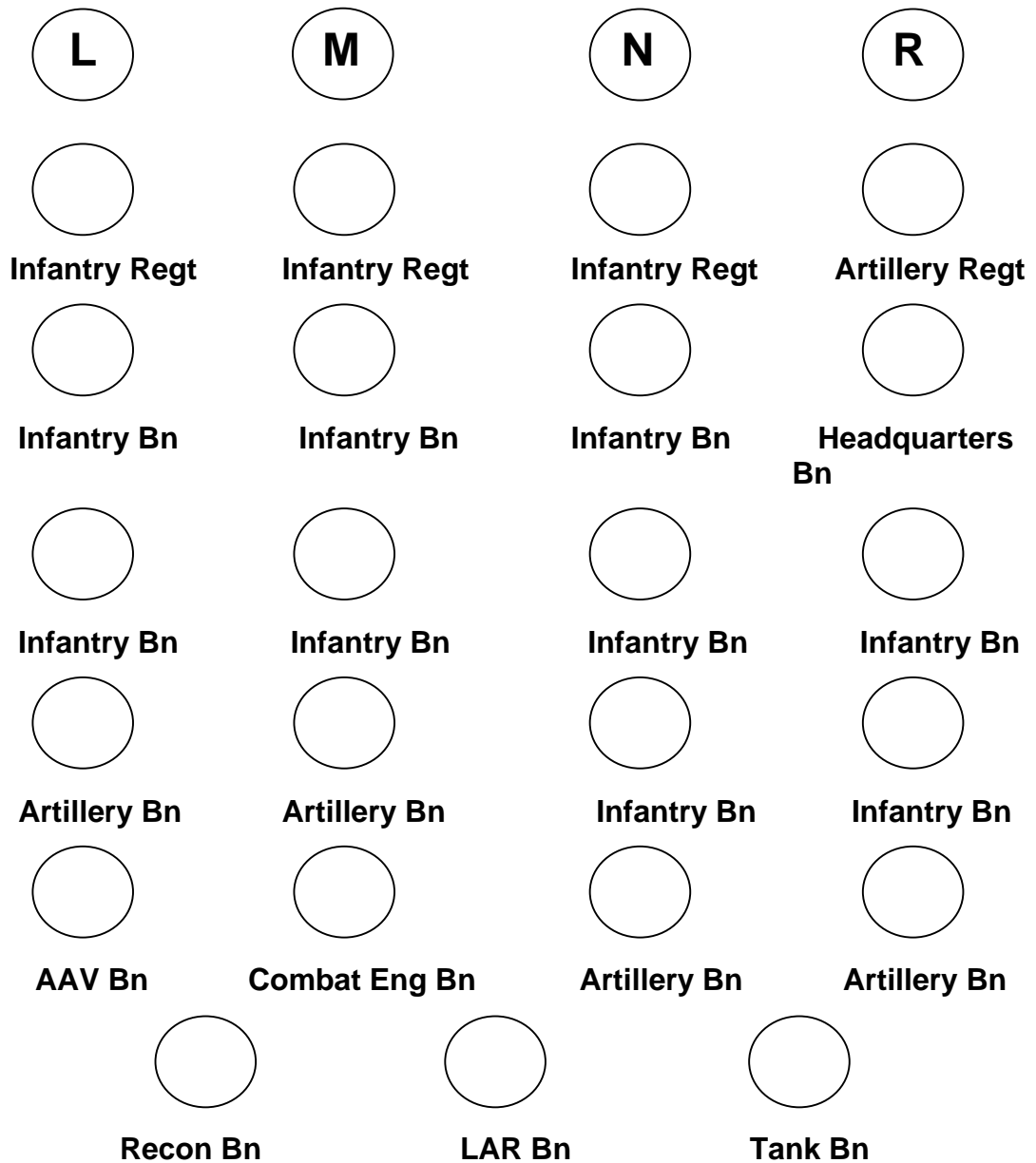

e. Massed Colors.

(Using a Marine Division as an example)

Figure 7-4.--Color Guard Composition--Continued.

10. All colors carried by the color guard are attached to staffs of equal height. The standard color staff consists of a 9 1/2-foot, hardwood pole capped at each end by metal ferrules. The use of the all-metal staff is only authorized for Marine Barracks, Washington, DC. A metal spearhead screws into the top of the staff and a streamer attachment device may also be affixed to display an organization's award streamers. (See figure 7-5.) Streamers are placed with the senior streamer at the front of the staff. Subsequent streamers are then placed clockwise, around the staff, as symmetrically as possible.

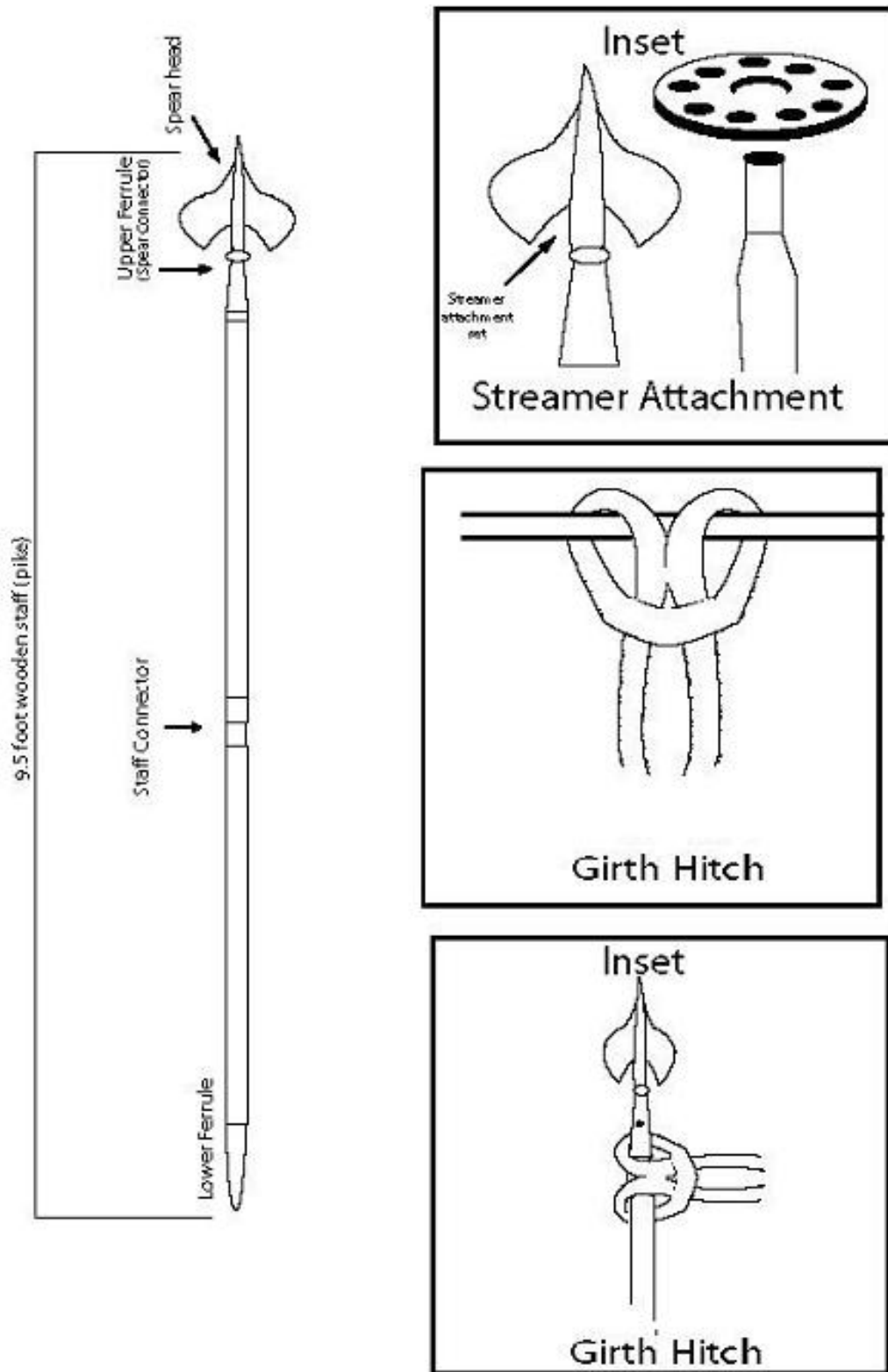

Figure 7-5.--The Color Staff.

7005. SYNCHRONIZING THE MANUAL OF ARMS FOR THE COLOR GUARDS ARMED WITH RIFLES

1. The manual of arms for color guards armed with rifles must be synchronized so that the rifles move (e.g., off of or to the shoulder) at the same time. Since the left rifleman is at left shoulder arms and the right rifleman is at right shoulder arms, moving to and from the right/left shoulder to the order, present or back the shoulder often involves different "counts" in the movement for each rifleman. To get the rifles moving together one or the other of the riflemen will have to do an occasional pause in the manual of arms so the other rifleman may catch up. When executing the rifle manual, both riflemen will wait for the senior color bearer's command of **"Ready, CUT"** before executing the final count of the movement.

a. Order Colors to Carry Colors. The command is **"Carry, COLORS."** This is a four-count movement for both riflemen. The right rifleman goes to right shoulder arms and the left rifleman goes to the left shoulder arms.

b. Carry Colors to Order Colors. The command is **"Order, COLORS."** This is a four-count movement for the right rifleman and a five-count movement for the left rifleman. In order to have the rifles move to the order together, the "counts" are modified as follows: (See figure 7-6.)



a. Start.



b. Count One.
 Right Rifle Stands Fast. Left Rifle, Re-grasps the Small of the Stock.

Figure 7-6.--Carry Colors to Order Colors.



c. Count Two.
Both Rifles Moved from the Shoulder.



d. Count Three.
Both Riflemen Re-grasp the Barrel.



e. Count Four.
Both Rifles Moved to the Right Side.



f. Count Five.
Ready Cut.

Figure 7-6.--Carry Colors to Order Colors--Continued.

c. Order Colors to Present Colors. The command is **"Present, COLORS."** This is a two-count movement for both riflemen, with both executing present arms with the rifle.

d. Present Colors to Order Colors. The command is **"Order, COLORS."** This is a three-count movement for both riflemen, with both executing order arms with the rifle.

e. Carry Colors to Present Colors. The command is **"Present, COLORS."** This is a three-count movement for both riflemen; however, it becomes a four-count movement to synchronize the rifles being brought from the left and right shoulder to present arms. (See figure 7-7.)



a. Start.



b. Count One.

Right Rifle	Left Rifle, Re-grasps
Stands Fast.	the Small of the Stock.

Figure 7-7.--Carry Colors to Present Color.



c. Count Two.
Both Rifles Moved from the Shoulder.



d. Count Three.
Right Rifle Re-grasps the Small of the Stock. Left Rifle, Stands Fast.



e. Count Four.
Both Rifles Rotated to Present Arms.

Figure 7-7.--Carry Colors to Present Color--Continued.

f. Present Colors to Carry Colors. The command may be **"Carry, COLORS"** or **"Shoulder, ARMS."** This is a three-count movement for the left rifleman and a four-count movement for the right rifleman to return the weapons to the left and right shoulder from present arms. (See figure 7-8.)



a. Start.



b. Count One
Both Rifles Rotated to Port Arms.



c. Count Two.
Right Rifle, Grasps Left Rifle,
the Butt of the Rifle. Stands Fast.



d. Count Three.
Both Rifles Moved to the Shoulder.

Figure 7-8.--Present Colors to Carry Colors.



e. Count Four.
Ready Cut.

Figure 7-8.--Present Colors to Carry Colors--Continued.

CHAPTER 7

NATIONAL AND ORGANIZATIONAL FLAGS

SECTION 1: MANUAL OF THE COLORS

7100. ORDER COLORS

1. At order colors, the lower ferrule rests on the deck touching the outside edge of the right shoe. The staff is gripped in a strong grip with the thumb wrapped around the front of the staff with the fingers wrapped to the rear. The right elbow is held close to the side so the forearm will help support the staff. The upper staff rests in the hollow of the right shoulder. The staff is vertical with the flat side of the spearhead facing front. The color bearer is at attention. (See figure 7-9.)

2. Color guards armed with rifles are at order arms when the colors are at the order.



Figure 7-9.--Order Colors.

7101. CARRY COLORS FROM ORDER COLORS

1. When changing from order colors to carry colors, the command is **"Carry, COLORS."**
 2. At the Command **"Carry,"** change the grip on the staff to the "V" grip so as to grip it from the rear between the thumb and fingers of the right hand with the fingers around the staff.
 3. At the command **"COLORS,"** raise the staff smartly with the right hand to a point where the lower ferrule is just above the sling socket. While raising it, keep the staff vertical. Grasp the staff at the lower ferrule with the left hand to steady it and align it with the sling socket. Do not look down.
- NOTE: All organizational colors will be raised to the carry with the national colors.
4. Seat the lower ferrule in the sling socket. As the ferrule is seated, permit the right hand to slide down the staff to a position directly in front of the color bearer's chin. (See figure 7-10a.)
 5. Color guards armed with rifles execute right and left shoulder arms at the command **"COLORS"** so that the rifles are on the outboard shoulders as described in paragraph 7005.
 6. All members of the color guard will halt their movements before executing the last count. (See figure 7-10b.) On the senior color bearer's command **"Ready, CUT,"** all members will move their free hands smartly to their sides. (See figure 7-10c.) If the color staffs need additional support due to high winds, the color bearers will grip the staff with their left hands just below their right.



a. Raising Staff Seating the Ferrule.

Figure 7-10.--Carry Colors from Order Colors.



b. Last Count.



c. Carry Colors.

Figure 7-10.--Carry Colors from Order Colors--Continued.

7102. ORDER COLORS FROM CARRY COLORS

1. When changing from carry colors to order colors, the command is **"Order, COLORS (ARMS)."** Execution is begun on the preparatory command.
- 2. At the command **"Order,"** grip the staff with the left hand above the ferrule and remove the staff from the sling socket. The staff remains centered on the body with the ferrule just forward of the sling socket. (See figure 7-11a.)
- 3. At the command **"COLORS,"** lower the staff to a point approximately 2 inches above the deck along the outside edge of the right shoe; release the staff with the left hand and re-grip it above the right hand. (See figures 7-11a and 7-11b.)
4. Relax both hands so the staff will slide down until the ferrule rests on the deck. Then trim or strip the colors by maintaining a grip on the staff with the left hand and raising the right hand to lightly grasp the fabric of the colors. Pull it down along the staff (do not attempt to throw or tuck it) and re-grip the staff with the right hand, with the fabric under the right arm. (See figures 7-11c and d.) Then change the position of the right hand to that described for order colors.
5. Color guards armed with rifles will execute order arms from right and left shoulder as described in paragraph 7005.1a. All members of the color guard will halt their movements before executing the last count. The senior color bearer will then command **"Ready, CUT,"** at which time all members of the color guard will return their left hands smartly to their sides and color guards will assume order arms. (See figure 7-11e.)



a. Removing the Ferrule.

Figure 7-11.--Order Colors from Carry Colors.

Enclosure (1)

7-28

Ch 1



b. Lowering the Staff.



c. Trimming the Colors.

Figure 7-11.--Order Colors from Carry Colors--Continued.



d. All Movement Halted.



e. Movement Complete.

Figure 7-11.--Order Colors from Carry Colors--Continued.

7103. PRESENT COLORS FROM ORDER COLORS

1. To change from order colors to present colors the command is **"Present, COLORS (ARMS)."** Execution is begun on the preparatory command.
2. At the command **"Present,"** change the grip on the staff in the same manner as for carry colors. **The national color bearer executes the movement to carry colors.**
3. At the command **"COLORS,"** organizational color bearer executes the movement to carry colors. The color guards execute present arms. (See figure 7-12.)
4. On the senior color bearer's command **"Ready, CUT,"** only the color bearers will move their left hands smartly to their sides.



Figure 7-12.--Present Colors from Order Colors.

7104. SALUTES BY THE ORGANIZATIONAL COLORS

1. Once the color guard is at present colors, and when appropriate, the organizational color bearer will render a salute with the organizational colors by straightening the right arm and lowering the staff naturally to the front. The staff will rotate naturally as it goes forward causing the sharp edge of the spearhead to face down. (See figure 7-13.)
2. Salutes by the organizational colors are not automatic when presenting colors. They will be rendered only during honors to national colors, to the commander of the organization represented by the colors or to an individual senior in rank to the organizational commander. (e.g., during a parade or review when the adjutant presents the command to the commander of troops, the organizational colors does not salute, unless the commander of troops is the organizational commander or of higher rank.)
3. When musical honors are played, the organizational colors will salute on the first note of music. The colors will be returned to the vertical position following the last note of music or the last volley of a gun salute. If no music is to be played and a color salute is appropriate, the organizational colors will salute immediately after the color guard has gone to present colors.
4. When marching, the salute is rendered when 6 paces from the reviewing stand or person to be saluted. Carry colors is resumed when 6 paces beyond the reviewing stand or person to be saluted.



Figure 7-13.--Salutes by the Organizational Colors.

7105. ORDER COLORS FROM PRESENT COLORS

1. When changing from present colors to order colors, the command is **"Order, COLORS (ARMS)."**
- 2. At the command **"Order,"** if the organizational colors are still saluting, it will be brought back to the vertical position with the flat side of the spearhead facing the front. The color bearers then grip the staff with the left hand above the ferrule and remove the staff from the sling socket. The staff remains centered on the body with the ferrule just forward of the sling socket.
3. At the command **"COLORS,"** all colors are brought to the position of order colors. Color guards execute order arms from the shoulder as described in paragraph 7005.1a. Colors are trimmed, if necessary, and the command **"Ready, CUT"** is given in the same manner as for order colors from carry colors.

7106. PRESENT COLORS FROM CARRY COLORS

1. To change from carry colors to present colors, the command is **"Present, COLORS (ARMS)."**
2. At the command of execution **"COLORS,"** the color guards execute present from the shoulder as described in paragraph 7005.1d.
3. The national color bearer remains at carry colors.
4. The organizational color will salute if appropriate.

7107. CARRY COLORS FROM PRESENT COLORS

1. To change from present colors to carry colors, the command is **"Carry, COLORS."**
2. At the command **"Carry,"** if the organizational colors are saluting, it will be brought back to the vertical position with the flat side of the spearhead facing the front.
3. At the command **"COLORS,"** color guards return to the shoulder as described in paragraph 7005.1f. Before executing the last count, the color guards will await the senior color bearers command **"Ready, CUT."**

7108. RESTS WITH THE COLORS

1. The color guard assumes the parade rest position in lieu of at ease or rest. At ease or rest are not used by the color guard when carrying uncased colors. Only the senior color bearer or person in charge of a formation with which colors are posted gives the command from the position of order color. It is executed in one count.
2. At the command **"Parade, REST;"** **"AT EASE;"** or **"REST,"** all members of the color guard execute parade rest. The color staff will remain along the color bearer's side and will not be thrust forward as with a guidon staff. (See figure 7-14.) The national and organizational colors bearers will grasp the sling socket with their left hand.

Enclosure (1)



a. Front View.



b. Rear View.

Figure 7-14.--Color Guard at Parade Rest.

7109. EYES RIGHT (LEFT) FROM CARRY OR ORDER COLORS

1. The command is **"Eyes, RIGHT (LEFT)."** It will be given only when marching at carry colors or while halted at order colors.
2. When marching at carry color, at the command **"RIGHT,"** all members of the color guard except the national color bearer and the individual on the right turn their head and look 45 degrees to the right. When the reviewing officer of a parade is entitled to a salute by the organizational colors, the salute is executed at the command **"RIGHT."** (See figure 7-15b.)
3. When marching at carry color, at the command **"LEFT,"** all members of the color guard except the national color bearer and the individual on the extreme left turn their head and look 45 degrees to the left. When the reviewing officer of a parade is entitled to a salute by the organizational colors, the salute is executed at the command **"LEFT."**
4. When halted at order color, at the command **"RIGHT,"** all members of the color guard except the national color bearer turn their head and look 45 degrees to the right. (See figure 7-15a.) The organizational color cannot salute from order color.
5. When halted at order color, at the command **"LEFT,"** all members of the color guard except the national color bearer turn their head and look 45 degrees to the left. The organizational color cannot salute from order color.



Figure 7-15a.--Eyes Right, Halted.



Figure 7-15b.--Eyes Right, Marching.

7110. CARRY OR ORDER COLORS FROM EYES RIGHT (LEFT)

1. The command is **"Ready, FRONT."**
2. When marching at carry colors, at the senior color bearer's command **"Ready,"** if the organizational colors saluted, it resumes to the carry. At the command **"FRONT,"** all members of the color guard who executed eyes right (left) will return their head and eyes smartly to the front.
3. When at order colors during a review when the reviewing officer troops the line, ready front will not be given after eyes right. During such a ceremony, members of the color guard who executed eyes right, will follow the reviewing officer with their eyes, turning their heads back toward the front as he passes by. Once the reviewing officer is directly in front of them, all movement of the head and eyes is halted.

7111. TRAIL ARMS WITH THE COLORS

1. When performing indoor ceremonies in a location that the doors, ceilings, etc. are not high enough to carry colors in the normal manner, the colors would be carried at the trail.
 2. Trail arms is assumed without command on any command that will cause the color guard to move. (e.g., **"Forward, MARCH;"** **"Right Turn, MARCH;"** etc.)
 3. Color bearers, on the preparatory command, raise the staff 6 inches off the deck. Color guards assume trail arms. (See figure 7-16.)
 4. On the command of execution, step off and move a short distance until given the command to halt.
- NOTE: If necessary to lower the colors to clear a doorway reach across the body with the left hand and grasp the colors. Left forearm is straight and parallel to the deck, with the palm to the rear. All colors are tilted forward sufficiently to clear the door or ceiling spearhead flat to the front.
5. When the command to halt is given the color bearers return the colors to the order and move the left arm back to the left side. Color guards armed with rifles return to the order.



Figure 7-16.--Marching at Trail Colors.

CHAPTER 7

NATIONAL AND ORGANIZATIONAL FLAGS

SECTION 2: MOVEMENTS OF THE COLOR GUARD.

7200. FACE THE COLOR GUARD TO THE RIGHT (LEFT)

1. The command is "**Right (Left) Turn, MARCH.**" It may be executed while halted, marking time, or marching.

2. On the command "**MARCH,**" with the right (left) flank color guard acting as a stationary pivot, the color guard turns to the right (left) while half stepping until they face the new direction. When making the turn, all members of the color guard face the same direction maintaining their alignment. (See figure 7-17.) Upon completion of the turn, the color guard will be marking time. The senior color bearer must immediately give the next appropriate command, such as "**Forward, MARCH**" or "**Colors, HALT.**"

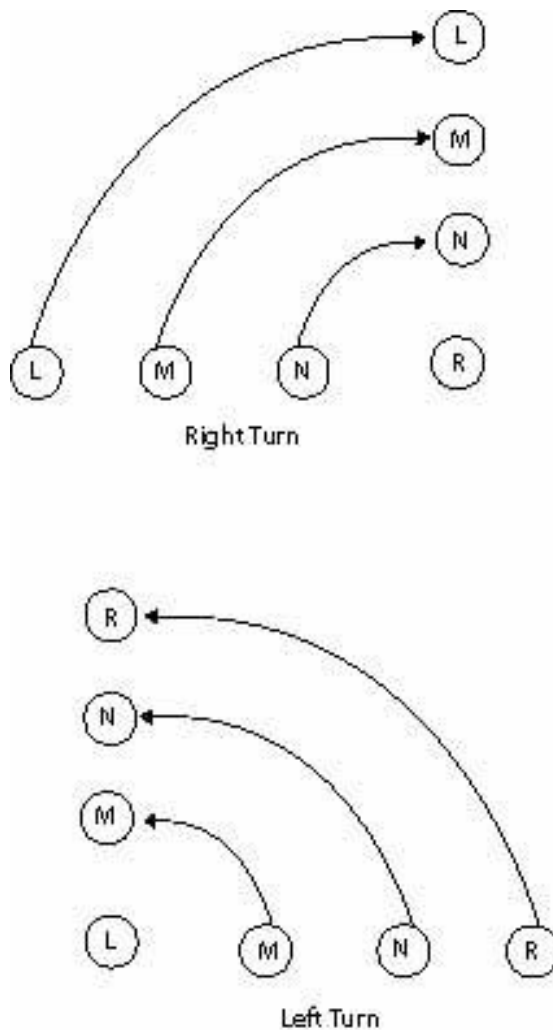

Figure 7-17.--Right (Left) Turn.

7201. FACE THE COLOR GUARD TO THE REAR

- 1. The command is **"Countermarch, MARCH."** It may be executed while halted, marking time, or marching. When marking time or marching, the command of execution **"MARCH"** is given as the left foot strikes the deck. When this command is given while marking time or marching, the color guard will take one more 2-inch vertical step in place or one more 30-inch step forward with the right foot before starting the half steps for this movement. If executed from the halt, the color guard will immediately begin the designated steps starting with the left foot. (See figure 7-18.)
2. The national color bearer pivots to the left, moving into the position formerly occupied by the organizational color bearer, facing the new direction of march and begins marking time.
3. The organizational color bearer takes one half step forward, pivots to the right outside the national color bearer, moving into the position formerly occupied by the national color bearer, facing the new direction of march and begins marking time.
4. The right color guard takes two half-steps forward, pivots to the left, outside the organizational color bearer, moving into the position formerly occupied by the left color guard, facing the new direction of march and begins marking time.
5. The left color guard takes three half-steps forward, pivots to the right outside the right color guard, moving into the position formerly occupied by the right color guard, facing the new direction of march and begins marking time.
6. Upon completion of this movement, the entire color guard marks time until it is halted or until it receives the command **"Forward, MARCH"** or **"Colors, HALT."**

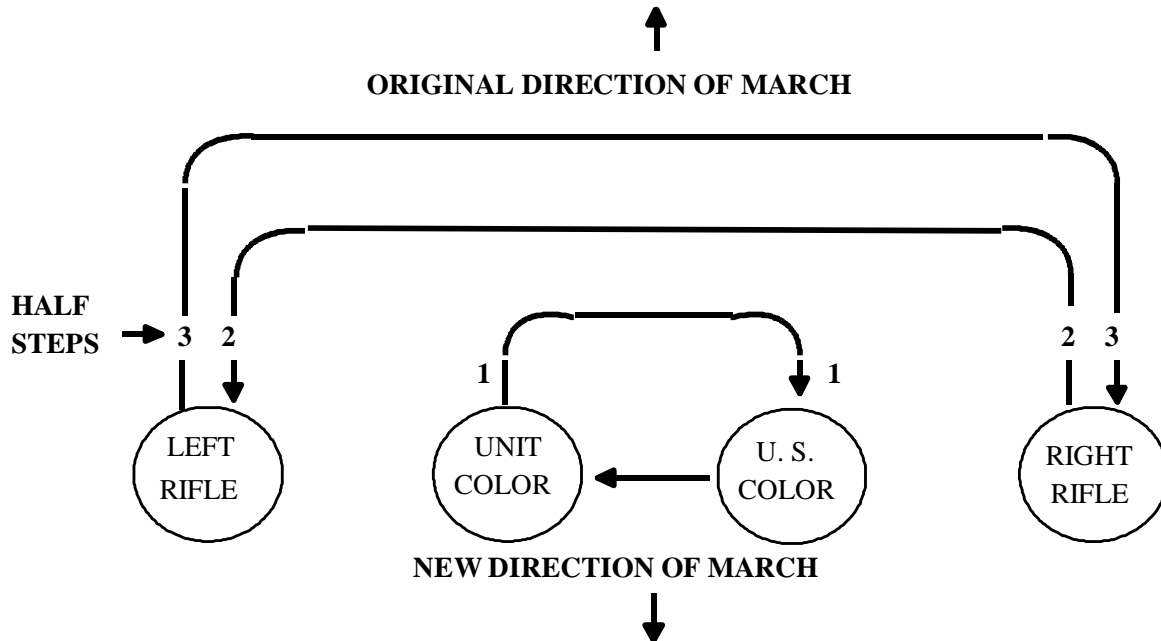

Figure 7-18.--Countermarch.

Enclosure (1)

7-40

Ch 1

7202. MOVEMENTS UTILIZED BY JOINT COLOR GUARDS (JCG). JCGs use two basic movements to turn the color guard 90 or 180 degrees. These are the **"Right (Left) Wheel, MARCH"** and the **"Left About, MARCH."**

7203. RIGHT (LEFT) WHEEL. This movement is used to turn the JCG 90 degrees right or left and may be executed either from the halt, mark time, or quick time. In JCGs with an even number of members, the pivot point will be between the two, center color bearers. In JCGs with an odd number of members, the pivot point will be the spot occupied by the center color bearer.

1. On the command of execution **"MARCH,"** the JCG will start marking time. At the same time, they will begin to turn slowly to the right/left while maintaining their alignment. For **"Right Wheel,"** those to right of the pivot back step and those to the left half step until facing the new direction. This procedure is reversed for **"Left Wheel."**

2. Once facing the new direction of march (90 degrees), the JCG will either halt or step off in the new direction, depending on commands by the senior color bearer.

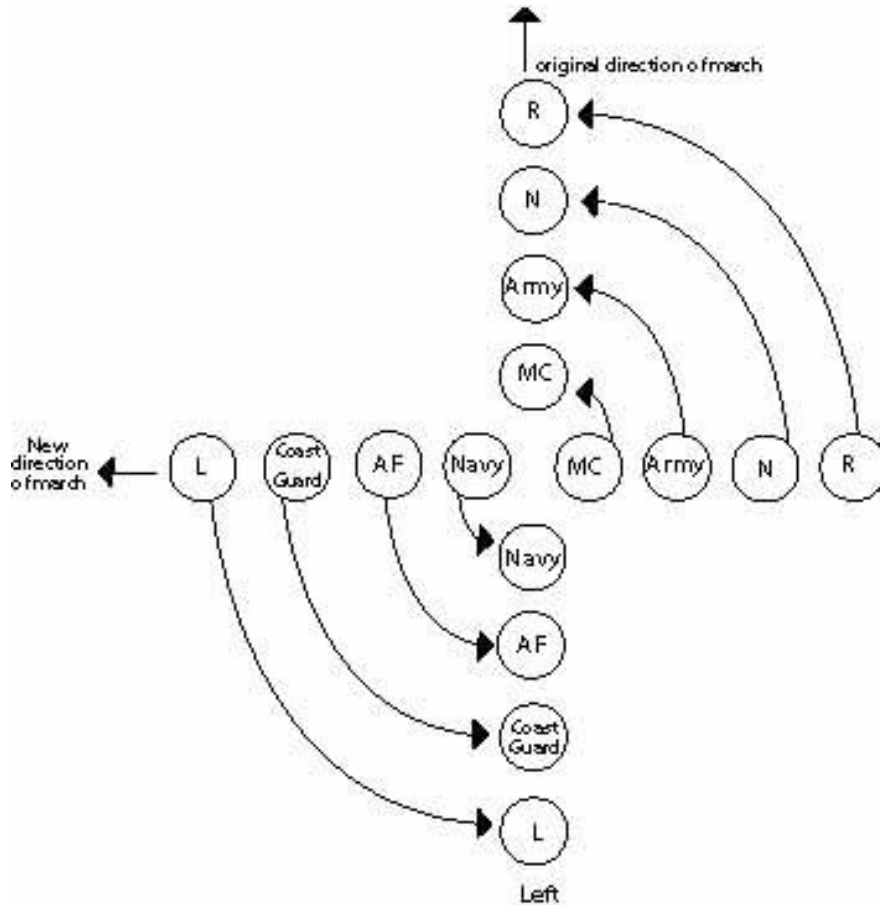

a. Pivot with Even Number.

Figure 7-19.--Right (Left) Wheel About.

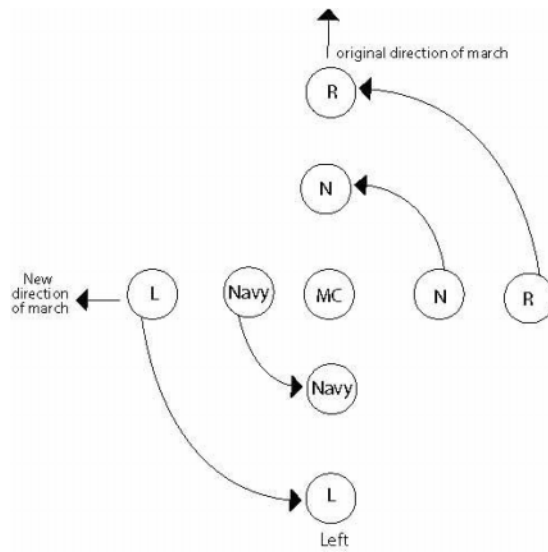

b. Pivot with Odd Number.

Figure 7-19.--Right (Left) Wheel About--Continued.

7204. LEFT ABOUT. This movement is used to turn the JCG 180 degrees, and it may also be executed while halted, marking time, or quick time. On the command of execution "**MARCH**" it is executed in the same manner as above. The only exceptions are the pivot point; the degree of turn and it is only executed to the left.

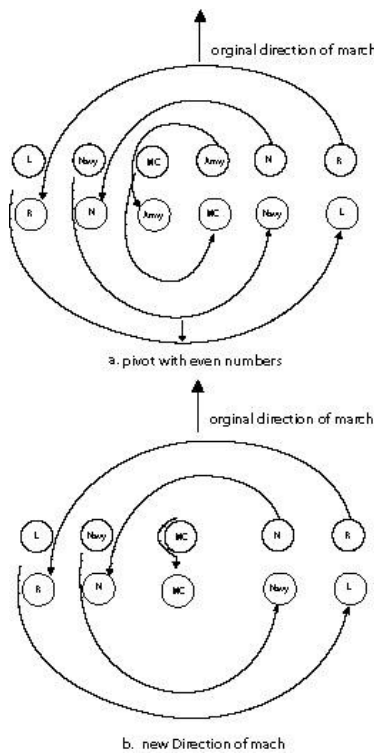

Figure 7-20.--Left About.

CHAPTER 7

NATIONAL AND ORGANIZATIONAL FLAGS

SECTION 3: COLOR GUARD PROTOCOL

7300. GENERAL. The primary mission of the color guard is to ensure that the national colors is handled and displayed with the utmost care and respect. Upon receiving or uncasing the national colors, the color guard assumes a ceremonial posture; meaning that all movement will be by marching at attention and the most relaxed halted position will be parade rest.

7301. RECEIVING THE COLORS BY THE COLOR GUARD. The color guard will use the following procedure in receiving the colors: (See figure 7-21.)

1. The color guard forms and marches to the place designated for receiving the colors.
2. The color guard is halted 3 paces from the adjutant and sergeant major that have taken appropriate positions for the delivery of the colors to the guard.
3. The senior color bearer commands the color guard to **"Order, ARMS."**
4. When the adjutant is ready to deliver the colors, the senior color bearer orders **"Present, ARMS."** At this command, the color bearers execute a hand salute, the color guards present arms.
5. The adjutant steps to the left oblique and transfers the national colors to the senior color bearer, who terminates salute in time to receive it at the position of carry colors. The adjutant then steps back and salutes.
6. Upon the adjutant's salute, the sergeant major, steps to the right oblique and transfers the organizational colors to the junior color bearer, who terminates salute in time to receive it at the position of carry colors. The senior enlisted then steps back and salutes.
7. When the senior enlisted salutes, the senior color bearer commands **"Order, ARMS."** The adjutant and senior enlisted terminate their salutes and the command of **"ARMS"** and march off.
8. The senior color bearer then marches the color guard to the color company (battalion).

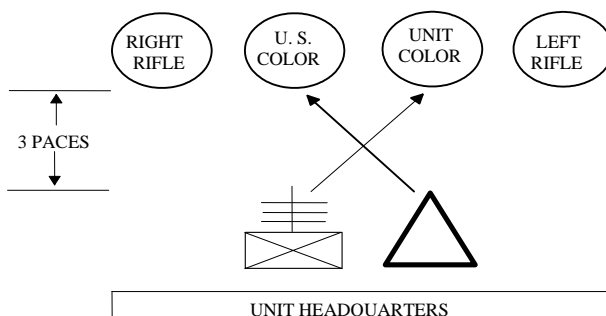

Figure 7-21.--Receiving/Returning the Colors by the Color Guard.

7302. RECEIVING THE COLORS BY THE COLOR COMPANY (BATTALION). Prior to forming for a ceremony in which the colors are to participate, the colors are to participate, the colors are received by the color company (battalion) by means of the following ceremony: (See figure 7-22.)

1. The company (battalion) is formed with its commander facing front.
2. The color guard approaches and halts 10 paces in front of and facing the company (battalion) commander remaining at the carry.
3. The company (battalion) commander faces about, towards the unit, and orders **"Present, ARMS."** The color guard executes present arms on the company (battalion) commander's command. The organizational colors salutes, if appropriate. The company (battalion) commander faces about again and salutes the colors.
4. The company (battalion) commander terminates salute, faces about, and commands **"Order, ARMS."** The color guard returns to the carry.
5. The company (battalion) commander faces about and orders the color guard to **"POST THE COLORS."** When the color company (battalion) is in line or mass, the post of the guard is 6 paces to the left of the company (battalion). When the company (battalion) is in column, the post of the guard is 6 paces behind.
6. When the color company (battalion) joins the formation, the color guard takes its appropriate post centered in the formation.
7. When in formation, the color guard executes parade rest when the color company (battalion) executes at ease or rest. The color guard will respond to all commands from the commander of troops or the commander of the color company (battalion) except when required by its unique movements to act independently.

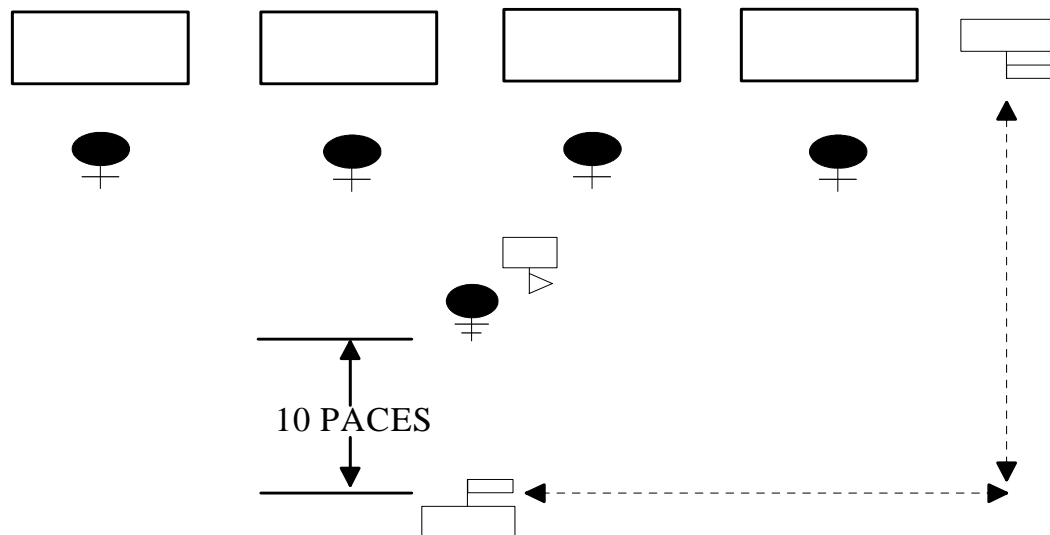

Figure 7-22.--Receiving/Returning the Colors by the Color Company.

7303. DISMISSING THE COLOR GUARD. In dismissing the color guard at the conclusion of a drill or ceremony, the procedure is as follows: (See figure 7-22.)

1. The guard marches from its post and halts 10 paces in front of and facing the company (battalion) commander, halts and remains at the carry.
2. The company (battalion) then executes present arms in the same manner described for receiving the colors, after which the color guard marches the colors to the quarters or office of the organizational commander.
3. The color guard is received by and dismissed from organizations smaller than a company (e.g., funeral escort) in a similar manner.

7304. RETURNING THE COLORS BY THE COLOR GUARD. The color guard will use the following procedure when parting with the colors: (See figure 7-21.)

1. The senior color bearer halts the guard 3 paces in front of the adjutant and senior enlisted who have taken positions near the office or quarters of the organization in time to receive the colors. The guard remains at carry colors.
2. When the color guard halts, the adjutant and senior enlisted salute. The Senior Enlisted, then terminates the salute and steps to the right oblique, receives the organizational colors from the junior color bearer, and then steps back.
3. The adjutant then terminates the salute and steps to the left oblique, receives the national colors from the senior color bearer, and then steps back.
4. The senior color bearer then commands "**Present, ARMS.**" The color guards execute present arms, the color bearers hand salute. The adjutant faces about and the senior enlisted passes behind him to a position on the left. They then march into the office or quarters of the commanding officer where the colors are placed without further ceremony.
5. When the colors are out of sight or 6 paces away, the senior color bearer commands "**Order, ARMS,**" and dismisses the guard or marches them back to their unit.

7305. CASING AND UNCASING THE COLORS

1. While it is not a precision movement, casing and uncasing the colors should be accomplished with appropriate dignity and ceremony.
2. To uncase the colors, the color guard will be formed at carry colors. The supernumerary or other designated individual(s) will center on the color guard. First the national color bearer and then the organizational color bearer will lower their staffs so that the cases may be removed. The individual(s) removing the cases will then step back and salute the national colors before retiring. (See figure 7-23a.)
3. To case the colors, the color guard will be formed at carry colors. The individual(s) with the cases will center on the color guard and salute the national colors. The organizational color bearer followed by the national color bearer will lower their staffs so that their colors may be furled and cased. Rather than

wrapping the colors around the staff, the colors should be folded on top of the staffs and held until the cases are slipped on. The rope and tassel and streamers, if any, are kept clear until the colors are folded onto the staff, and then are placed as flat as possible, on the colors. This may require two persons to accomplish. (See figure 7-23b.) Care should be taken to ensure that color cases fit easily over the colors. Cases constructed with too narrow of a diameter cause undue wrinkling and may even damage the colors.



a. Uncasing Colors.



b. Casing Colors.

Figure 7-23.--Uncasing and Casing Colors.

7306. TROOPING THE COLORS

1. When it is desired to highlight the unit colors and have them formally received by the entire battalion (or regiment) while forming for a review, parade, or any other ceremony, the ceremony for trooping the colors may be conducted. It is particularly appropriate to include trooping the colors as a part of ceremonies conducted to coincide with an important event in the unit's history. However, if the colors are to be brought forward for a retirement, promotion, awards or other similar type ceremony the colors should not, but may, be trooped since this would cause the command to present arms to the colors twice. (Once when the colors are trooped and once when they are brought forward for the awards or other ceremony)

2. Procedures for Trooping the Colors

a. After forming at "Assembly," the color guard receives the battalion (regimental) colors as prescribed in paragraph 7301. The color company may also receive the color guard per paragraph 7302, or the color guard may take its position on the battalion (regimental) parade deck independently. In the former case, coincidental with "Adjutant's Call," the color guard initially marches on with the color company then breaks out of formation so as to take post on the left flank of the line of troops. In the latter case, the color guard marches independently on the parade ground and takes post on the left flank of the line of troops at "Adjutant's Call," or prior to "Adjutant's Call," as appropriate. (See figure 7-24.) Regardless, after taking post on the left flank, the color guard goes to order colors.

→ b. The troops form at "Adjutant's Call" according to the commands and procedures prescribed for forming a battalion (regiment) for ceremonies, up to the point where the units complete dressing to the right, the guides are posted (if units marched on), and bayonets are fixed (if so prescribed). Then, the adjutant facing the command and posted midway between the line of company (battalion) commanders and the battalion (regimental) commander, commands "**MARCH ON THE COLORS.**" The band plays appropriate music while the color guard, coming to the carry, marches from its position on the left flank, across the front of the battalion (regiment) along a line parallel to the line of troops and midway between the adjutant and line of company (battalion) commanders. Company (battalion) commanders and the company guide (battalion staff) salute the colors as they pass their front. Those company (battalion) commanders who are not passed by the colors will not salute. On reaching a point in front of the adjutant, the color guard executes a left turn to face the adjutant and halts, remaining at the carry. The adjutant then commands "**Present, ARMS**" and salutes the colors. The unit presents arms. The color guard executes present arms from the carry. The band plays either "To the Color" or the "National Anthem." The battalion (regimental) commander and staff to salute on the first note of the music and terminate the salute on the last note. After completion of the music, the adjutant commands "**Order, ARMS.**" The color guard returns to carry color on the command "**Order, ARMS.**" The adjutant then commands "**POST THE COLORS.**" The color guard countermarches, moves to the line of troops on the left of the color company (battalion), countermarches to face the front, halts, and goes to order colors.

c. After the color guard is in position on the left of the color company (battalion), the parade or ceremony would proceed as prescribed in the appropriate chapter of this Manual.

Enclosure (1)

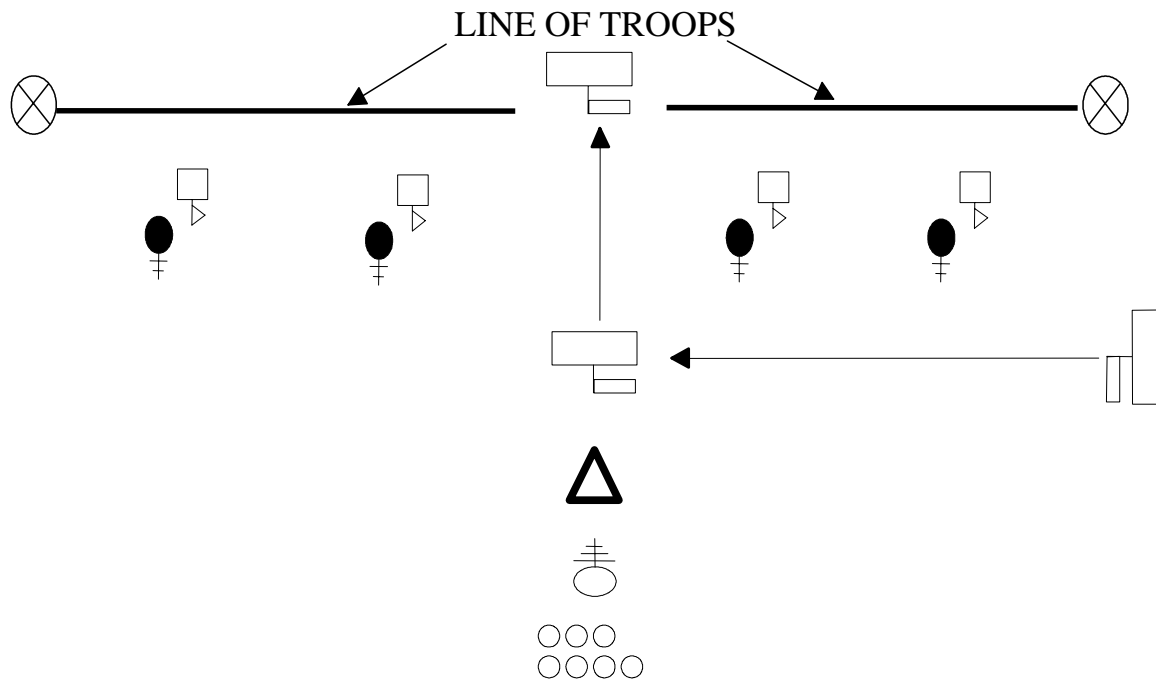

Figure 7-24.--Trooping the Colors.

7307. INDOOR CEREMONIES INVOLVING COLOR GUARDS

1. On occasion color guards will be required for indoor ceremonies, military or civilian. Normally an indoor ceremony consists of marching on the colors, the "National Anthem," (or pledge of allegiance), posting the colors and retiring the colors. Close coordination with the master of ceremonies, and an on-site rehearsal (if possible) are needed to preclude confusion and misunderstandings during the ceremony.

2. The Normal Sequence of Events Should be as Follow

a. The master of ceremonies asks the guests to please rise for the march on the colors and to remain standing for the "National Anthem" and the posting of the colors.

b. The color guard marches in from the designated entry and moves to its position, and does a right (left) turn or countermarch to face the audience and remains at the carry. The senior color bearer then gives the command "**Present, COLORS.**" The color guard executes. After the "National Anthem" is played the senior color bearer gives the command "**Carry, COLORS.**" The senior color bearer would then give the commands necessary to move the color guard to 3 paces in front of where the colors are to be posted, halts and gives the command to "**Order, COLORS.**" Once the color guard is at the order, the organizational color bearer then steps to the right oblique and places the organizational colors in the stand. Once the organizational color bearer is back in position the national color bearer steps to the left oblique and places the national colors into the stand. (See figure 7-25.) When the national color bearer is back in position the senior color

bearer commands "**Present, ARMS.**" The riflemen execute present arms and the color bearers execute a hand salute. The senior color bearer then commands "**Order, ARMS;**" "**Shoulder, ARMS;**" and then using whatever commands necessary, marches the color guard from the auditorium.

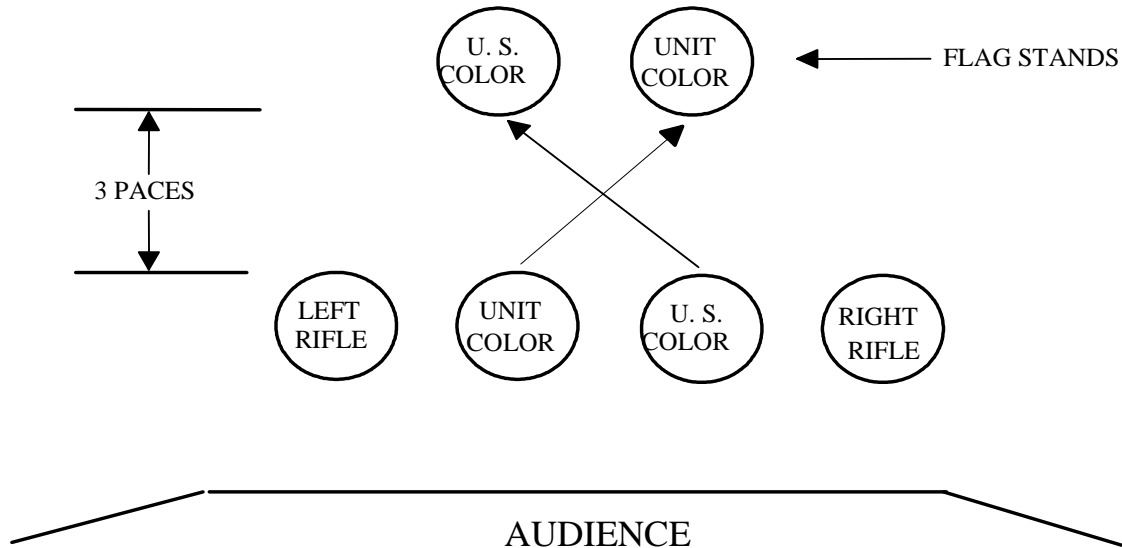

Figure 7-25.--Posting and Retrieving the Colors Indoors.

3. When it is time to retire the colors, the color guard assumes its position to re-enter the auditorium for that part of the ceremony.

a. The master of ceremonies would then ask for the guests to rise for the entering of the colors.

b. The color guard marches to a position 3 paces in front of where the colors are posted, halts and goes to the order. (See figure 7-25.) The senior color bearer then commands "**Present, ARMS,**" the riflemen execute present arms and the color bearers execute a hand salute. The senior color bearer then commands "**Order, ARMS.**" The color guard goes to the order. The national color bearer then steps to the left oblique and retrieves the national colors. When the national color bearer is back in position the organizational color bearer steps to the right oblique and retrieves the organizational colors. When the organizational color bearer is back in position the senior color bearer commands, "**Carry, COLORS**" and then, using whatever commands necessary, marches the color guard from the auditorium.

4. When performing an indoor ceremony, oddities will be encountered that will necessitate some adjustments by the color guard. Some examples are:

a. If performing in a house of worship, covers are not worn and weapons are not carried. Those portions of the ceremony requiring present arms are deleted and the riflemen may be omitted.

b. The ceiling may be too low to carry colors; march in at the trail.

c. The aisles may be too narrow for a color guard to march in normal formation. The color guard would then march in by two's (See figure 7-26) or in column of ones. (See figure 7-27.) If marching in by twos then the color bearers lead and the riflemen follow. Upon reaching the spot for presenting the colors, the riflemen would step into their normal position. If marching in a column of ones the order of march is **ALWAYS**, right color guard, national color bearer, organizational color bearer, left color guard. When reaching their spot the color guard would reform. Make sure the colors don't reform inverted.

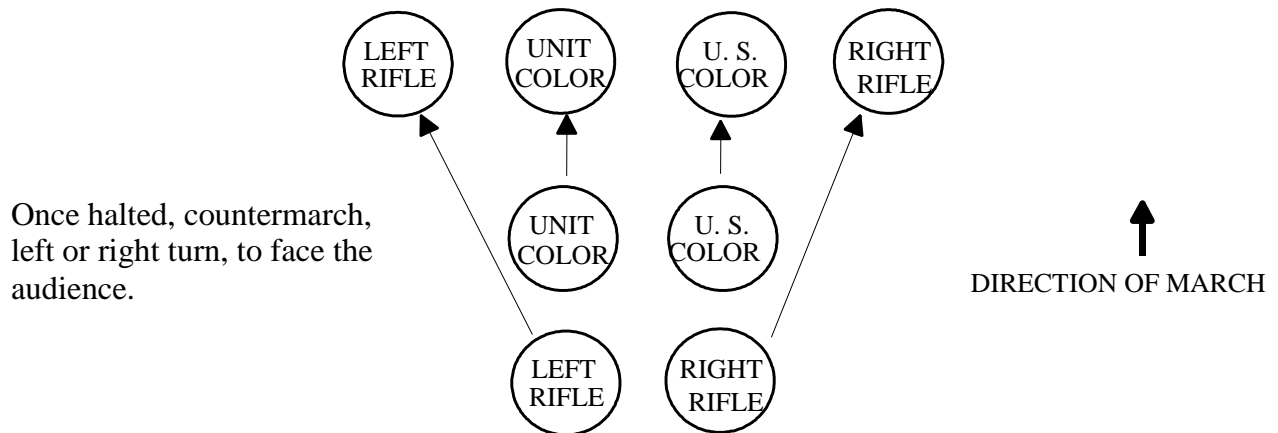

Figure 7-26.--Marching in Column of Twos and Reform.

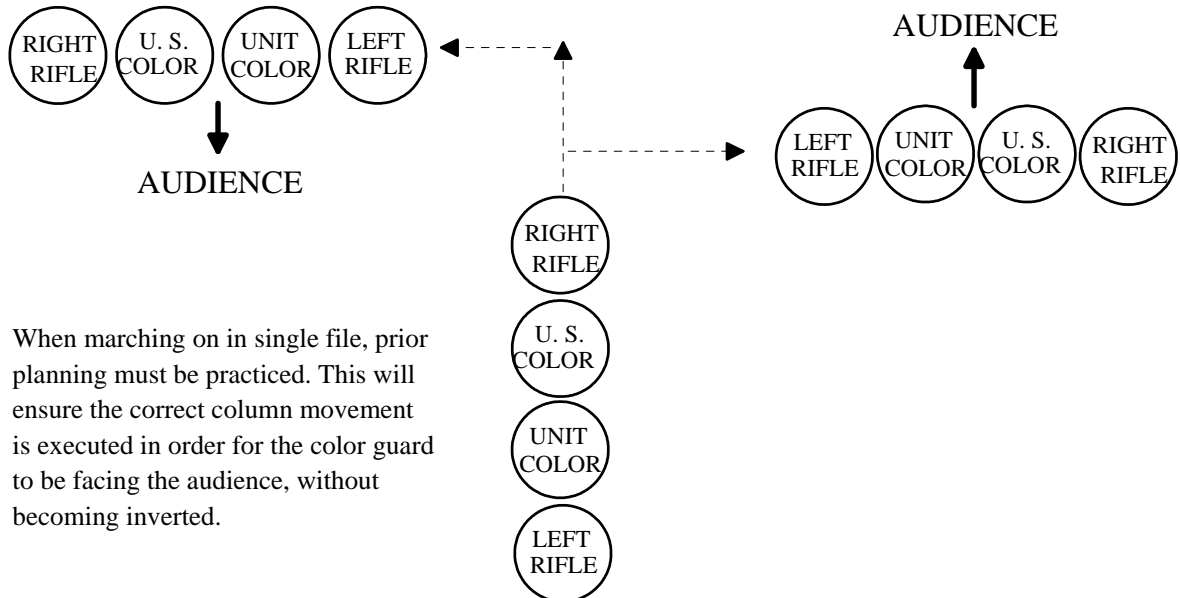

Figure 7-27.--March in Column of Ones and Reform.

d. The flag stands you will be posting the colors into may be on different sides of the stage. If this occurs, the recommended sequence is:

(1) Execute the ceremony as discussed earlier.

(2) After the "National Anthem" the colors countermarch and halt facing the new direction. The senior color bearer would command post the colors. The national color bearer and right rifleman step off to the left oblique and move to the flag stand and mark time. The right rifleman positions himself so as to be outboard of the national colors. After the national color bearer and right rifleman have cleared, the organizational color bearer and left rifleman step off in the right oblique and move to the flag stand and mark time. The left rifleman positions himself so as to be outboard of the organizational colors. (See figure 7-28.) Once both colors are in position the senior color bearer commands "**Colors, HALT,**" and "**Order, COLORS.**" The organizational colors is placed in the flag stand, then the national colors is placed in the flag stand. The senior color bearer then commands "**Present, ARMS.**" The riflemen execute present arms and the color bearers execute a hand salute. The senior color bearer then commands "**Order, ARMS;**" "**Center, FACE;**" and "**Forward, MARCH.**" The riflemen march at trail arms. The color guard moves to the center of the stage and marks time, slowly turning left or right towards the audience. The senior color bearer then commands, "**Colors, Halt;**" "**Shoulder, ARMS;**" and then marches the color guard from the auditorium.

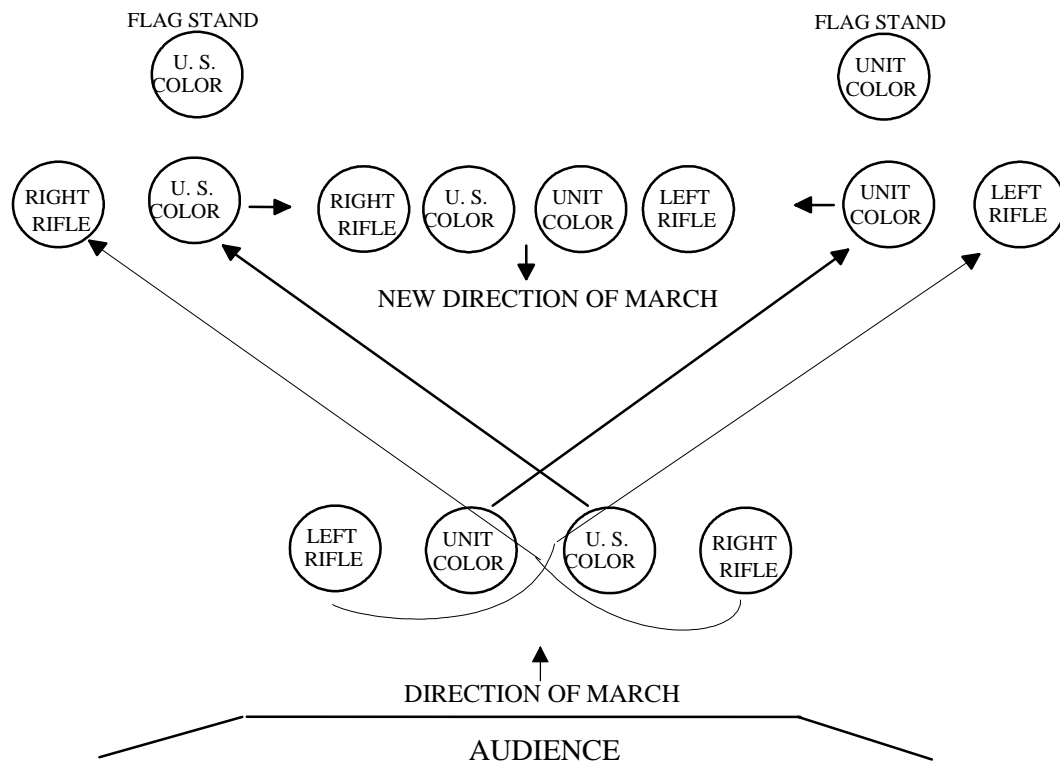

Figure 7-28.--Posting and Retrieving the Colors Indoors (Flag Stands Separated).

(3) To retire the colors from separated flagpoles, the detail is marched into position facing the colors and halts. The senior color bearer then commands **"Present, ARMS."** The color guard riflemen execute present arms and the color bearers execute a hand salute. The senior color bearer then commands **"Shoulder, ARMS."** The riflemen return to the shoulder. The national color bearer and right rifleman then step off to the left oblique and move to the flag stand and mark time. The right rifleman positions himself so as to be outboard of the national colors. After the national color bearer and right rifleman have cleared, the organizational color bearer and left rifleman step off in the right oblique and move to the flag stand and mark time. The left rifleman positions himself so as to be outboard of the organizational colors. (See figure 7-25.) Once all are in position the senior color bearer commands **"Colors, HALT,"** and **"Order, ARMS."** The senior color bearer then retrieves the national colors. The organizational color bearer then retrieves the organizational colors. The senior color bearer then commands **"Center, FACE,"** and **"Forward, MARCH."** The color guard, at trail arms, moves to the center of the stage and marks time, slowly turning left or right towards the audience. The senior color bearer then commands **"Colors, HALT;"** **"Carry, COLORS;"** and then marches the color guard from the auditorium.

e. The rule of thumb for all unusual situations not covered by this Manual is to perform in a military manner. However, never do something that would embarrass the Corps.

7308. ORDERING COLORS, STAFFS AND OTHER CEREMONIAL GARRISON PROPERTY

1. Instructions for ordering flags, streamers, guidons and other heraldic items is found in MCO P10520.3B, section G. The list in appendix C contains the description, and National Stock Numbers of flags, staffs and other color guard equipment. The unit supply officer should be able to assist in finding the current prices and ordering the equipment.

2. Table 1, section E of MCO P10520.3B is used to determine which type of organizational color a unit rates.

MARINE CORPS DRILL AND CEREMONIES MANUAL

PART I: DRILL

CHAPTER 8

SQUAD DRILL

	<u>PARAGRAPH</u>	<u>PAGE</u>
GENERAL	8000	8-3
TO FORM THE SQUAD	8001	8-4
TO DISMISS THE SQUAD	8002	8-6
TO COUNT OFF	8003	8-6
TO ALIGN THE SQUAD	8004	8-6
TO OBTAIN CLOSE INTERVAL FROM NORMAL INTERVAL IN LINE	8005	8-9
TO OBTAIN NORMAL INTERVAL FROM CLOSE INTERVAL IN LINE	8006	8-9
TO OBTAIN DOUBLE ARM INTERVAL IN LINE	8007	8-9
TO OBTAIN NORMAL INTERVAL FROM DOUBLE ARM INTERVAL IN LINE .	8008	8-10
TO FORM A COLUMN FROM IN LINE AND REFORM TO A LINE	8009	8-10
TO MARCH IN THE OBLIQUE	8010	8-11
TO MARCH TO THE REAR	8011	8-12
TO MARCH TO THE FLANK	8012	8-13
TO CHANGE DIRECTION OF A COLUMN	8013	8-13
TO FORM A COLUMN OF TWOS FROM A SINGLE FILE	8014	8-14
TO FORM A SINGLE FILE FROM A COLUMN OF TWOS	8015	8-15
TO STACK ARMS	8016	8-16
TO TAKE ARMS	8017	8-18

FIGURE

8-1	SQUAD FORMATIONS	8-3
8-2	SIZING SQUADS	8-4
8-3	DRESS RIGHT DRESS	8-7
8-4	AT CLOSE INTERVAL DRESS RIGHT DRESS	8-8

	<u>PAGE</u>
8-5	DRESS LEFT 8-8
8-6	MARCHING TO RIGHT OBLIQUE 8-11
8-7	FORMING COLUMN OF TWOS FROM SINGLE FILE 8-14
8-8	FORMING SINGLE FILE FROM COLUMN OF TWOS 8-15
8-9	POSITIONS OF STACKMEN AND INDIVIDUALS TO THE RIGHT AND LEFT AT THE END OF THE FIRST STEP IN STACK ARMS 8-17
8-10	INSERTING RIFLES INTO THE STACKMEN'S FLING LOOP 8-17
8-11	FINAL POSITION OF STACK ARMS 8-18

PART I: DRILL

CHAPTER 8

SQUAD DRILL

8000. GENERAL

1. A squad is a group of individuals formed for the purpose of instruction, discipline, control, and order.

2. Members of the squad take positions, move, and execute the manual of arms as stated in this Manual. All individuals execute the movements at the same time. Squads may drill as squads or as part of a platoon or larger formation.

3. Squads are kept intact when practicable. The normal formation for a squad is a single rank (squad in line) or single file (squad in column). (See figure 8-1.) This permits variation in the number of individuals composing the squad. The first formation is always in line. Column formation may be taken from line formation. A squad, not at drill, may be marched in column of twos by forming in two ranks.

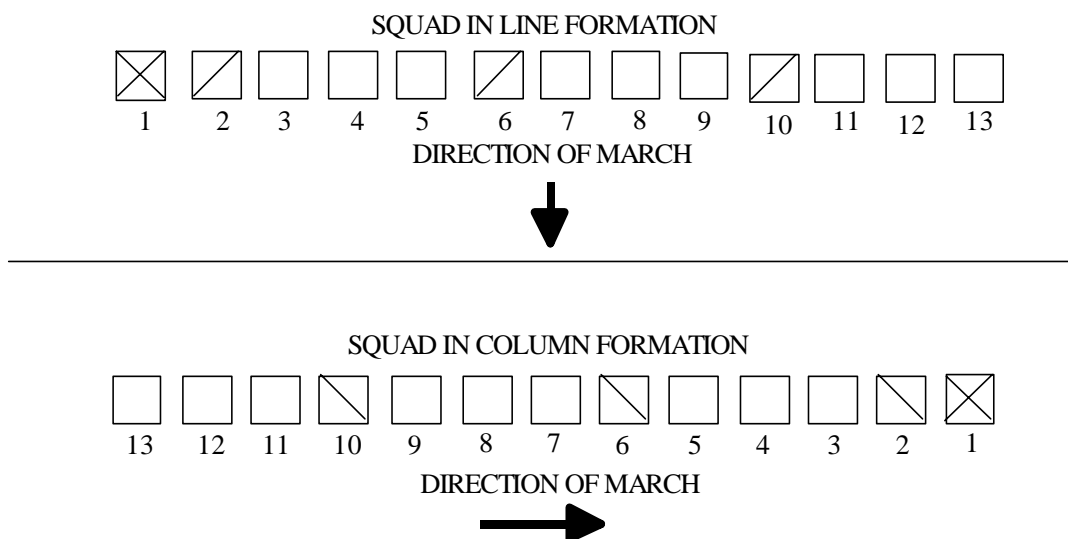

Figure 8-1.--Squad Formations.

4. The squad marches in line for minor changes of position only.

5. When the Squad is Armed with Rifles

a. The command **"Right (Left) Shoulder, ARMS;" "Port, ARMS;"** or **"Sling, ARMS"** is given before commanding the squad to move, except for short distances. When moving short distances the command **"Trail, ARMS"** may be given or it may be executed automatically.

b. At the command **"Squad, HALT"** remain at the position of right shoulder (left shoulder, port or sling) arms until **"Order, ARMS"** or some other manual command is given.

6. In this Chapter the term "unit leader," (e.g., "The unit leader then checks the alignment) means the individual drilling the squad. He/she may be the squad leader, other noncommissioned officer, or squad member drilling the squad for an inspection or evaluation. If the unit leader is the squad leader, then the number two Marine (see figure 8-1) executes the movements of the squad leader. The unit leader must maintain proper distance (3 paces) from the squad and remain centered on the squad during all drill movements.

a. If the squad executes a right step, the unit leader, who is facing the squad, would execute a left step in cadence with the squad to maintain proper position. For a right step the unit leader would execute a left step.

b. If the squad executes a back step, the unit leader would execute a half step, in cadence with the squad to maintain proper position.

c. Movements of the unit leader during other squad movements are explained in the paragraph describing the movement.

8001. TO FORM THE SQUAD

1. Members of the squad normally form as indicated in figure 8-1. (e.g., maintain fire team/section integrity). However, for parades and ceremonies where appearance is more important, the squads should be sized. To size the squad the tallest member takes position 2 in figure 8-1 with the shortest squad member in position 13. The squad leader, regardless of height, always forms as the squad leader, in position one of figure 8-2.



a. Squad Formed with Unit Integrity.

Figure 8-2.—Squads Sizing



b. Squad Sized.

Figure 8-2.--Sizing Squads--Continued.

2. To form at normal interval, the command is "**FALL IN.**"
3. The squad forms in line on the left of the squad leader. Each member of the squad, except the individual on the left flank, raises their left arm shoulder high in line with their body. Fingers are extended and joined, palm down thumb extended along the forefinger. Each individual except the squad leader turns their head and looks to the right. To obtain a normal interval, everyone places himself in line so their right shoulder touches the fingertips of the person on their right. As soon as each individual is in line with the person on their right, and the person on their left has obtained normal interval, they assume the position of attention smartly but quietly.
4. To form at close interval, the command is "**At Close Interval, FALL IN.**"
5. The squad forms in line on the left of the squad leader. Each member of the squad, except the individual on the left flank, places their left hand on their hip, elbow in line with the body. They rest the heel of the palm on the hip with fingers extended and joined and pointing down. Everyone except the squad leader turns their head and looks to the right. To obtain close interval, they place themselves in line so their right arm touches the elbow of the person on their right. As soon as each individual is in line with the person on their right, and the person on their left has obtained close interval, they assume the position of attention smartly but quietly.
6. If the squad is armed, members fall in with weapons at the position of order arms. Weapons are inspected at once unless a report is to be taken. If so they will be inspected immediately following the report with the following commands: "**Inspection, ARMS;**" "**Port, ARMS;**" and "**Order, ARMS.**"

8002. TO DISMISS THE SQUAD

1. The squad is dismissed only from a line with individuals at attention.
2. Armed troops are dismissed with the commands "**Inspection, ARMS;**" "**Port, ARMS;**" and "**DISMISSED.**"
3. Unarmed troops are dismissed with the command "**DISMISSED.**"

8003. TO COUNT OFF

1. In line, the command is "**Count, OFF.**" At the command "**OFF,**" everyone except the squad leader, turn their heads 90 degrees over the shoulder and look to the right. The squad leaders shout ONE. The person in the file to the left of the squad leaders turns his/her head smartly back to the front and at the same time shouts TWO. After the person to their right has shouted their number, each subsequent person to the left turns his/her head back to the front and at the same time shouts the next higher number. Numbers are counted off in quick time cadence.
2. In column, on the command "**From Front to Rear, Count, OFF,**" the squad leader smartly turns his/her head to the right 90 degrees over the shoulder and shouts ONE as the head is turned back to the front. Each subsequent rank, having seen the person's head in front of them return to the front, turns his/her head to the right and shouts the next higher number as the head is turned smartly back to the front. This is carried on in sequence at quick time cadence.

8004. TO ALIGN THE SQUAD

1. The purpose of these movements is to dress the alignment of the squad. They may be executed when the squad is halted at attention in line. The commands are "**Dress Right (Left), DRESS**" or "**At Close Interval, Dress Right (Left), DRESS.**" These commands are given only when the squad is at approximately the same interval as the interval at which the dress is commanded.

2. Dress Right Dress

a. On the command "**Dress Right, DRESS,**" everyone except the squad leader, smartly turn their heads to the right, 90 degrees over the shoulder look, and align themselves. At the same time, everyone except the individual on the left flank, provide interval by smartly raising their left arm to shoulder height and in line with their body. Fingers are extended and joined, thumb along the forefinger, palm down. (See figure 8-3.)

b. As the base of the movement, the squad leader keeps his/her head and eyes to the front. All other members of the squad position themselves by short steps until their right shoulders lightly touch the fingertips of the person on their right.

c. The unit leader, on his/her own command of execution "**DRESS,**" faces half left, as in marching, and proceeds by the most direct route to a position on line with and one pace to the right of the individual on the right flank. At this position, the unit leader executes a halt in the oblique facing the rear of the formation, and then executes a right face, facing down the line of the squad. The unit leader aligns the squad by commanding those individuals in advance or rear of

the line to move forward or backward until in line. These individuals are designated by name or number. For example: **"Jones, FORWARD;"** or **"Number Three, BACKWARD."** Those individuals will move until receiving the command **"STEADY."** The unit leader may execute a series of short side steps to the right or left in order to identify an individual. However, prior to commanding the identified individual to move, the unit leader will be on line with the rank. After verifying the alignment of the squad, the unit leader faces to the right in marching, marches straight to a point 3 paces beyond the squad, halts, faces to the left, and commands **"Ready, FRONT."** Immediately after commanding **"FRONT,"** the unit leader marches by the most direct route back to a post 3 paces front and centered on the squad.

d. On the command **"Ready, FRONT,"** all members of the squad who raised their left arm and turned their head to the right, will smartly but quietly lower their arm to their side and at the same time turn their head back to the front, assuming the position of attention.

e. When aligning a squad of well-drilled troops or when there is insufficient time to verify alignment, the unit leader may command **"Ready, FRONT"** from his/her normal position (3 paces front and centered), without having verified alignment.



Figure 8-3.--Dress Right Dress.

3. At Close Interval Dress Right Dress. This movement is executed in the same manner as dress right dress except for the following:

a. On the command **"At Close Interval, Dress Right, DRESS,"** those individuals providing interval will do so by placing the heel of their left hand on their hip with the elbow in line with their body. Fingers are extended and joined and pointing down. Members gaining interval will move by short steps until their right arm is touching the left elbow of the individual to their left. (See figure 8-4.)



Figure 8-4.--At Close Interval Dress Right Dress.

4. Dress Left Dress and at Close Interval Dress Left Dress. These movements are similar to dress right dress and at close interval dress right dress except that alignment is made toward the left. The individual on the left flank of the rank is the base of the movement and stands fast. On the command **"Dress Left, DRESS"** or **"At Close Interval, Dress Left, DRESS,"** everyone except the individual on the left flank smartly turn their heads to the left, look, and align themselves. At the same time they will smartly raise their left arm or elbow to provide interval (the left arm is used for both dress right and dress left). The unit leader will verify alignment of the squad from its left flank. (See figure 8-5.)



Figure 8-5.--Dress Left.

5. To align in column, the command is "**COVER.**" At this command, members move as necessary to place themselves directly behind the person in front of them, still maintaining a 40-inch distance.

8005. TO OBTAIN CLOSE INTERVAL FROM NORMAL INTERVAL IN LINE

1. The purpose of this movement is to close the interval between individuals of a squad in line to 4 inches. It may be executed when the squad is halted at attention and in line at normal interval. The command is "**Close, MARCH.**"

2. The squad leader is the base of this movement. On the command of execution "**MARCH,**" the squad leader stands fast and places his/her left hand on his/her hip, as if dressing at close interval, to provide interval for the individuals to the left. At the same time, all other members of the squad face to the right as in marching, march toward the right flank until approximately 4 inches from the person in front of them, halt, and face to the left. They then execute at close interval dress right dress. After aligning and without command, they will smartly lower their left hands and turn their heads to the front as soon as the individual to their left has touched their elbow with his/her right arm and stopped moving.

3. On his/her command of execution, the unit leader steps to the left in marching. He/she marches parallel to the squad maintaining a distance of 3 paces from the squad. When approximately on the center of the squad at close interval the unit leader halts and faces the squad. He/she then adjusts to the center of the squad by taking small steps left, right, forward or back.

8006. TO OBTAIN NORMAL INTERVAL FROM CLOSE INTERVAL IN LINE

1. The purpose of this movement is to extend the interval between individuals of a squad in line to one arm length. It may be executed when the squad is halted at attention and in line at close interval. The command is "**Extend, MARCH.**"

2. The squad leader is the base of this movement. On the command of execution "**MARCH,**" the squad leader stands fast and raises his/her left arm to shoulder height to provide interval for the person on the left. At the same time, all other members of the squad face to the left as in marching, march toward the left flank until they have opened approximately a 30-inch distance from the person behind them, halt, and face to the right. They then execute dress right dress. After aligning and without command, they will smartly, and quietly, lower their left arms and turn their heads to the front as soon as the individual to their left has touched their finger tips with his/her right shoulder and has stopped moving.

3. On his/her command of execution, the unit leader steps to the right in marching. He/she marches parallel to the squad maintaining a distance of 3 paces from the squad. When approximately on the center of the squad at normal interval the unit leader halts and faces the squad. He/she then adjusts to the center of the squad by taking small steps left, right, forward or back.

8007. TO OBTAIN DOUBLE ARM INTERVAL IN LINE

1. The purpose of this movement is to extend the interval between the individuals of a squad to a double arm distance. It may be executed when the squad is halted

at attention and in line at normal or close interval. If armed, rifles must be at sling arms. The command is **"Take Interval to the Left, MARCH."**

2. The squad leader is the base of this movement. On the command of execution **"MARCH,"** the squad leader stands fast and raises his/her left arm to shoulder height, to provide interval for the persons on the left. At the same time, all other members of the squad face to the left as in marching, march toward the left flank until they have opened approximately a 70-inch distance from the person behind them, halt, and face to the right. They then smartly turn their heads to the right and raise both arms to shoulder height. Individuals on the left flank will only raise their right arm. After aligning and without command, they will smartly, and quietly, lower their right arms and turn their heads to the front as soon as they have proper interval. They will lower their left arms when they feel the individual to their left lower his/her right arm.

3. On his/her command of execution, the unit leader steps to the right in marching. He/she marches parallel to the squad maintaining a distance of 3 paces from the squad. When approximately on the center of the squad at double arms interval the unit leader halts and faces the squad. He/she then adjusts to the center of the squad by taking small steps left, right, forward or back.

8008. TO OBTAIN NORMAL INTERVAL FROM DOUBLE ARM INTERVAL IN LINE

1. The purpose of this movement is to decrease the interval between individuals of a squad in line from double arm to normal interval. It can only be executed when the squad is halted at attention and in line at a double-arm interval. The command is **"Assemble to the Right, MARCH."** On the command of execution, the interval is reduced in a manner similar to close march; except that individuals halt approximately 30 inches from each other, face and execute the appropriate dress movement to obtain normal interval.

2. On his/her command of execution, the unit leader steps to the left in marching. He/she marches parallel to the squad maintaining a distance of 3 paces from the squad. When approximately on the center of the squad at normal interval the unit leader halts and faces the squad. He/she then adjusts to the center of the squad by taking small steps left, right, forward or back.

8009. TO FORM A COLUMN FROM IN LINE AND REFORM TO A LINE

1. When halted in line at normal interval and at the order if armed with rifles, the command to form a column is **"Right, FACE."** All members of the squad simultaneously face to the right, thereby forming column. The squad leader may then command **"Right (Left) Shoulder, ARMS;" "Port, ARMS;" "Sling, ARMS;"** or **"Forward (Column {Half} Right/Left), MARCH"** to cause the squad to march in column.

NOTE: The squad becomes inverted if faced to the left, this should be done only for short movements. When it is desired to form a column facing to the left, the squad should first form column by facing to the right, then execute necessary successive column movements until the column is faced in the desired direction.

2. When in line at close interval, the squad is first extended to normal interval (see paragraph 8006), then forms column by facing to the right as described above.

3. When in column at a halt and at the order, to form a line, the command is **"Left, FACE."**

8010. TO MARCH IN THE OBLIQUE

1. The purpose of this movement is to shift the line of march to the right or left and then resume marching in the original direction. It may be executed from any formation that is marching at quick time cadence. The command is **"Right (Left) Oblique, MARCH."** The word oblique is pronounced to rhyme with strike. The command of execution is given as the foot in the direction of the turn strikes the deck. The command to resume the original direction of march is **"Forward, MARCH."** The command of execution is given as the foot toward the original front strikes the deck.

2. To teach the squad to march to the oblique, the unit leader aligns the unit and has members face half right (left). The unit leader then explains that these positions are maintained when marching to the oblique. This is achieved by individuals keeping their shoulders parallel to the persons in front and/or adjacent to them. The squad leader is the base of the movement, and must maintain a steady line of march keeping his/her shoulders blocked perpendicular to the direction of march.

3. At the command **"Right Oblique, MARCH"** the command of execution is given as the right foot strikes the deck. Everyone then takes one more 30-inch step to the front with the left foot and pivots 45 degrees to the right on the ball of the left foot. Stepping out of the pivot with a 30-inch step, the entire squad marches to the right oblique until given another command. (See figure 8-6.) For the squad to resume marching in the original direction, the command is **"Forward, MARCH"** in this case the command of execution will be given as the left foot strikes the deck. Everyone then takes one more step in the oblique direction; pivots back to the original front and continue to march. To march to the left oblique, substitute left for right and right for left in the above sequence.

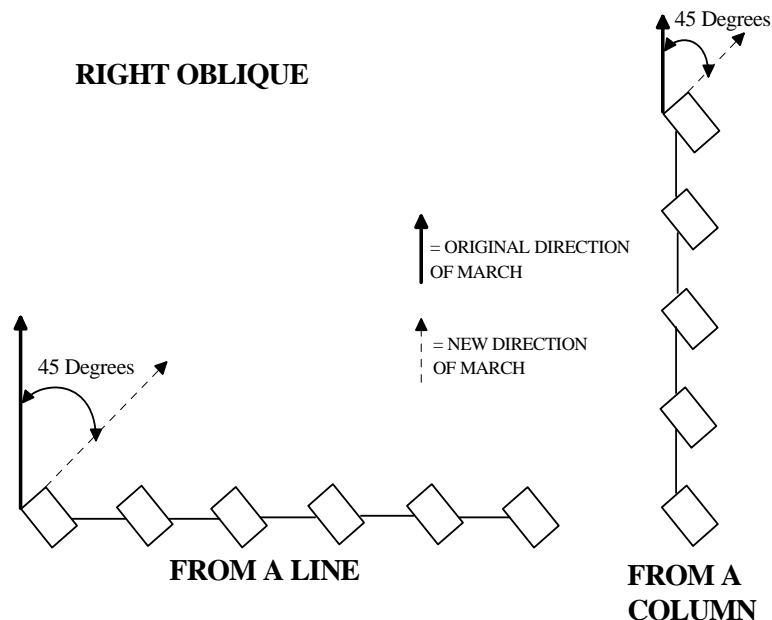

Figure 8-6.--Marching to Right Oblique.

4. To halt the squad facing in the original direction of march the command is **"Squad, HALT."** The command of execution **"HALT"** is given on the left foot when marching to the right oblique and on the right foot when marching to the left oblique. At the command **"HALT,"** everyone takes one more step in the oblique direction, pivots to the original front on the toe of the right (left) foot, and places the left (right) foot beside the other at the position of attention.
5. To temporarily halt the squad in the oblique direction, in order to correct errors, the command is **"In Place, HALT."** The command of execution **"HALT"** may be given as either foot strikes the deck. At the command of execution **"HALT,"** the squad halts in two counts as in quick time and remains facing in the oblique direction. The only command that can be given after halting in place is **"Resume, MARCH."** At that command, the movement continues marching in the oblique direction.
6. When given half step or mark time while marching in the oblique, the only commands that may be given are **"Resume, MARCH"** to continue marching with a 30-inch step in the oblique; or **"In Place, HALT"** to halt in the oblique in order to correct errors.

8011. TO MARCH TO THE REAR

1. The purpose of this movement is to march the squad to the rear for a short distance. It may be executed when halted or marching forward at quick time or double time. The command is **"To the Rear, MARCH."** The command of execution will be given as the right foot strikes the deck.
2. When halted, on the command of execution **"MARCH,"** everyone takes one 15-inch step to the front with the left foot and then pivots 180 degrees toward the right on the balls of both feet. Stepping out of the pivot with a 30-inch step, the entire squad marches to the rear. For the squad to resume marching in the original direction the command **"To the Rear, MARCH"** is given again. No other command may be given when marching to the rear until the unit has resumed marching to the original front.
3. When marching at quick time, on the command of execution **"MARCH,"** everyone takes one more 15 inch step to the front with the left foot and then pivots 180 degrees toward the right on the balls of both feet. Stepping out of the pivot with a 30-inch step, the entire squad marches to the rear. For the squad to resume marching in the original direction, the command **"To the Rear, MARCH"** is given again. No other command may be given when marching to the rear until the unit has resumed marching to the original front.
4. When marching at double time, on the command of execution **"MARCH,"** everyone takes two more 36-inch steps to the front and then four, 6-inch vertical steps in place at double time cadence. On the first and third steps in place, everyone pivots 180 degrees to the right. After the fourth step in place, and for the fifth step, they step off with a 36-inch step in the new direction. For the squad to resume marching in the original direction, the command **"To the Rear, MARCH"** is given again. No other command may be given when marching to the rear until the unit has resumed marching to the original front.

8012. TO MARCH TO THE FLANK

1. The purpose of this movement is to march the squad to the right or left flank for a short distance. It may be executed from any formation that is marching at quick time or double time cadence. The command is **"By the Right (Left) Flank, MARCH."** The command of execution is given as the foot in the direction of the turn strikes the deck.
2. To march to the right flank, when marching at quick time, the command is **"By the Right Flank, MARCH."** On the command of execution **"MARCH,"** everyone takes one more 30-inch step to the front with the left foot and then pivots 90 degrees to the right on the ball of the left foot. Stepping out of the pivot with a 30-inch step, the entire squad marches in line to the right flank. The unit leader executes the flanking movement with the squad maintaining his/her distance from the squad. For the squad to resume marching in the original direction, the command is **"By the Left Flank, MARCH."** To march to the left flank, substitute left for right and right for left in the above sequence. No other command may be given when marching to the flank until the unit has resumed marching to the original front.
3. When marching at double time, on the command of execution **"MARCH,"** everyone takes two more 36-inch steps to the front and then two, 6-inch vertical steps in place at double time cadence. While stepping in place, everyone turns 90 degrees toward the direction commanded and then steps off with a 36-inch step in the new direction. No other command may be given when marching to the flank until the unit has resumed marching to the original front.

8013. TO CHANGE DIRECTION OF A COLUMN

1. The purpose of this movement is to change the direction of march of a column. It may be executed when the squad is halted or marching in column. The command is **"Column Right (Column Left, Column Half Right, or Column Half Left), MARCH."** The squad leader establishes the pivot for the movement.
2. When marching, the commands of execution are given on the foot in the direction of the turn. On the command of execution **"MARCH,"** the squad leader takes one more 30-inch step to the front and then pivots 90 degrees to the right (left) on the ball of the left (right) foot. He/she then takes a 30-inch step in the new direction. The remaining members of the squad continue to march to the point where the squad leader pivoted. They would then pivot 90 degrees in the new direction of march.
3. When halted, at the command of execution **"MARCH,"** the squad leader faces to the right (left) as in marching and takes one 30-inch step in the new direction with the right (left) foot. The remaining members of the squad step off to the front as in forward march. The remainder of the movement is executed the same as in marching.
4. Column half right (left) is executed as described above except that the pivot is 45 degrees to the right (left).
5. During column movements, the unit leader executes the movement with the squad, maintaining proper distance from the squad.
6. For slight changes of direction, the command is **"INCLINE TO THE RIGHT (LEFT)."** At that command, the squad leader changes direction slightly as commanded. This is not a precision movement and is executed only while marching.

8014. TO A FORM COLUMN OF TWOS FROM SINGLE FILE

1. When the squad is halted in column, the command is **"Column of Twos to the Left (Right), MARCH."**
2. If squad members do not already know whether they are an odd or even number, the squad must be given count off before the above command is given.
3. On **"MARCH,"** the squad leader stands fast. Even-numbered squad members face half left (right) in marching, take two steps, face half right (left) in marching, and march forward to halt beside and at normal interval from the odd-numbered squad member who was originally in front of them. Odd numbered members, except the squad leader, march forward and halt as they attain a 40-inch distance from the odd-numbered member in front of them. All members required to move do so at the same time. (See figure 8-7.)

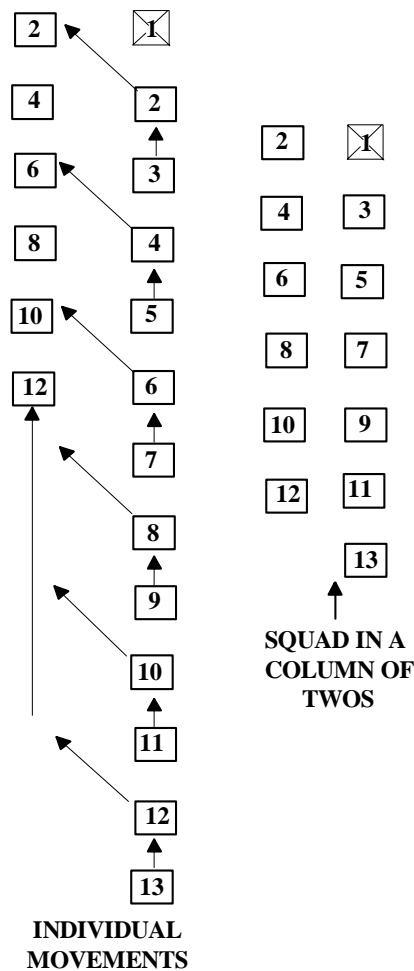

Figure 8-7.--Forming Column of Twos from Single File.

8015. TO FORM A SINGLE FILE FROM A COLUMN OF TWOS

1. When the squad is halted in column of twos, the command is **"Column of Files from the Right (Left), MARCH."** It is important to note, in order to keep from inverting the squad, that:

a. If a column of twos was built TO the LEFT, then a column of files must be formed FROM the RIGHT.

b. If a column of twos was built TO the RIGHT, then a column of files must be formed FROM the LEFT.

2. At the command **"MARCH,"** number one and two members step off at the same time. Number 1 moves forward as number 2 steps half right in marching, moves 2 steps, faces half left in marching, and follows number 1 at a 40-inch distance. Remaining odd and even numbered members step off in pairs, execute the same movements as numbers one and two, and follow in file. (See figure 8-8.)

a. When teaching this movement the unit leader should, after the command of execution **"MARCH,"** begin calling a cadence of "and, STEP, and, STEP." For example, on the command of execution **"MARCH,"** the number one and two squad members step off. On the first "and, STEP" the number three and four squad members step off. On the second "and, STEP" the number five and six squad members step off, etc. This cadence helps the squad member's step off at the correct time and keeps the squad in step.

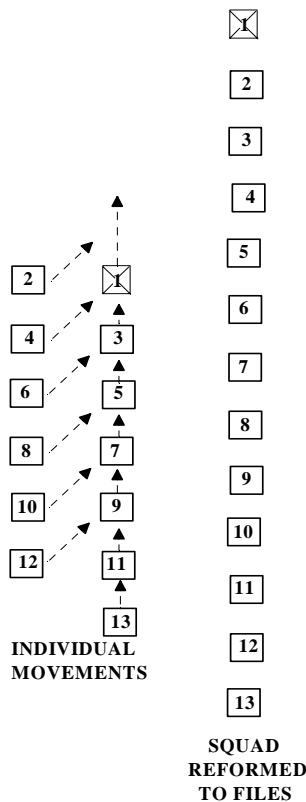

Figure 8-8.--Forming Single File from Column of Twos.

8016. TO STACK ARMS

1. The purpose of this movement is to temporarily relieve the squad of its weapons. It may be executed when the squad is halted in line. The command is **"Stack, ARMS;"** however, this command must be preceded by preliminary commands in order to prepare the squad to stack arms. Assuming the squad is halted in line at normal interval, the sequence of commands will be: **"Count, OFF,"** **"NUMBERS 3, 7 AND 11 ARE STACKMEN;"** **"Prepare, SLINGS;"** and **"Stack, ARMS."**

2. On the command **"Count, OFF,"** the squad counts off as prescribed in paragraph 8003.

3. Stackmen are designated by file number. The unit leader commands **"NUMBERS 3, 7 AND 11 ARE STACKMEN."** In other words the number 3, 7, and 11 persons in each squad are designated as stackmen. Additional stackmen may be designated if the squad has enough additional rifles to warrant it. The numbers 3, 7, and 11 are used to preserve fire team integrity for each weapons stack. If the squad is not divided into fire teams, numbers 2, 5, 8, and 11 may be designated stackmen. This reduces the number of extra weapons that must be added to the stacks.

4. On the command **"Prepare, SLINGS,"** the designated stackmen place the butt of their rifles on their right hip and cradle them in the crook of their right arm. They then adjust their slings to form a 4-inch loop next to upper sling swivel. As soon as they have prepared the loop, they return to order arms.

5. On the command **"Stack, ARMS,"** the designated stackmen place their weapons directly in front of and centered on their bodies with the sights to the rear. The heel of the rifle butt is placed on the ground on line with the toes of their shoes. Each stackman grasps the rifle at the upper portion of the handguard with the left hand, keeping the rifle vertical. The first two fingers of the left hand hold the inner part of the loop against the rifle. The stackman reaches across the front of the rifle with the right hand, grasps the outer part of the loop and holds it open for insertion of the rifles. (See figure 8-9.) At the same time, the individuals to the left and right of the stackmen perform the following movements simultaneously:

a. The individuals on the stackmen's right raise and center their weapons by bringing their right wrist to shoulder height and centered on their bodies, magazine well facing the front. They then grasp the handguards (midway) with the left hand, sling included in the grasp, release the right hand, and re-grasp the weapon at the small of the stock. Arms are then lowered to a dead hang, so that the weapons are held in a horizontal position with the muzzles to the left and magazine wells still to the front. (See figure 8-9.)

b. The individuals on the stackmen's left raise and center their weapons by bringing their right wrists to shoulder height and centered on their bodies, magazine wells face the front. They then grasp their weapons at the small of the stock with their left hands, sling included in the grasp, release their right hands and re-grasp the handguards (midway). Arms are lowered to a dead hang, so that the weapons are held in a horizontal position with the muzzles to the right and the magazine wells still to the front. (See figure 8-9.)



Figure 8-9.--Positions of Stackmen and Individuals to the Right and Left at the End of the First Step in Stack Arms.

c. As soon as the stackmen have placed their rifles in position, both the individuals to the right and left move their feet nearest the stackmen, 18 inches in the oblique toward the stackmen. The individuals on the stackmen's left insert the muzzles of their rifles into the loops to a point approximately halfway between the compensator and the front sight. They hold their weapons in this position until the individuals on the stackmen's right insert the muzzles of their rifles in a similar manner, but above the other rifle in each loop. (See figure 8-10.)



Figure 8-10.--Inserting Rifles Into the Stackmen's Sling Loop.

d. The butts of the rifles inserted into the loops are swung outward and down to the ground until the stacks are tight with the rifle butts on line and approximately 2 feet forward of the stackmen's rifle. The rifles rest on the side of the butts with the pistol grips pointing inboard toward each other. As each stack is completed, all three individuals stand up at the same time and resume the position of attention. (See figure 8-11.)



Figure 8-11.--Final Position of Stack Arms.

e. Extra rifles are passed to the nearest stacks on the right. Individuals holding extra rifles grasp the barrels of their rifle raise them vertically and then extend their right arms horizontally to the right front. The persons to the right grasp the weapons at the handguard, center them on their bodies grasp the barrels with their right hands and extend their right arms horizontally to the right front. This action is repeated until the rifles reach the stackmen. The stackmen lean the rifles against the center of the stacks in such a manner as to prevent them from falling or knocking the stacks over. The squad leader passes his/her rifle to the first stack on his/her left by raising the weapon with the right hand to a position centered on the body as in the first count of present arms from order arms figure 3-15b. He/she then grasps the weapon with the left hand at the handguards; sling included in the grasp, and passes the weapon to the left by extending the left arm horizontally to the left front. The individual to the squad leader's left then grasps the rifle at the barrel with the right hand, centers it on the body grasps the handguards with the left hand and passes it to the stackman.

8017. TO TAKE ARMS

1. The purpose of this movement is to recover arms that have been stacked. It may be executed only when the squad has fallen back in on the weapons stacks. The command is **"Take, ARMS."**

2. On the command of execution **"ARMS,"** if there are extra arms they are passed back in a reverse manner of the way they were passed to the stacks. When extra arms have been passed back, or if there were no extra arms, the stackmen grasp their rifles and hold the loops in the same manner as was done for stacking arms. The individuals to the left and right step in the oblique reach down and re-grasp their weapons and bring them to a horizontal position. The individual on the right removes his/her rifle first and resumes order arms or unsling arms. The individual on the left removes his/her weapon and resumes order arms or unsling arms. The stackman cradles his/her weapon and adjusts the sling and sling keeper to its original position and then resumes the order or unsling arms position.

MARINE CORPS DRILL AND CEREMONIES MANUAL

PART I: DRILL

CHAPTER 9

PLATOON DRILL

	<u>PARAGRAPH</u>	<u>PAGE</u>
GENERAL	9000	9-3
FORMATIONS	9001	9-3
POSTS OF INDIVIDUALS	9002	9-5
RULES FOR THE GUIDE	9003	9-5
TO FORM THE PLATOON	9004	9-6
TO DISMISS THE PLATOON	9005	9-7
TO COUNT OFF	9006	9-8
TO FORM COLUMN FROM LINE	9007	9-8
TO FORM LINE FROM COLUMN	9008	9-8
TO ALIGN THE PLATOON	9009	9-9
TO OBTAIN CLOSE INTERVAL FROM NORMAL INTERVAL IN LINE	9010	9-11
TO OBTAIN NORMAL INTERVAL FROM CLOSE INTERVAL IN LINE	9011	9-12
TO OBTAIN DOUBLE ARM INTERVAL IN LINE	9012	9-12
TO OBTAIN NORMAL INTERVAL FROM DOUBLE ARM INTERVAL	9013	9-13
TO OBTAIN CLOSE INTERVAL IN COLUMN	9014	9-13
TO EXTEND TO NORMAL INTERVAL IN COLUMN	9015	9-15
TO OPEN RANKS	9016	9-15
TO CLOSE RANKS	9017	9-16
TO STACK ARMS	9018	9-17
TO TAKE ARMS	9019	9-18
TO FORM FOR PHYSICAL DRILL	9020	9-19
TO CHANGE THE DIRECTION OF A COLUMN	9021	9-20
TO MARCH TO THE FLANK	9022	9-21

MARINE CORPS DRILL AND CEREMONIES MANUAL

	<u>PARAGRAPH</u>	<u>PAGE</u>
TO MARCH IN THE OBLIQUE	9023	9-23
TO MARCH TO THE REAR	9024	9-24
TO FORM A COLUMN OF TWOS OR FILES AND REFORM	9025	9-25

FIGURE

9-1	PLATOON IN LINE AT NORMAL INTERVAL	9-4
9-2	PLATOON IN COLUMN AT NORMAL INTERVAL	9-4
9-3	MOVEMENTS OF THE PLATOON COMMANDER WHEN ALIGNING THE PLATOON	9-10
9-4	CLOSE MARCH (WHILE MARCHING), RIGHT SQUAD BASE	9-14
9-5	EXECUTING COLUMN RIGHT (LEFT)	9-21
9-6	RIGHT (LEFT) FLANK	9-22
9-7	MARCHING TO RIGHT OBLIQUE	9-23
9-8	COLUMN OF TWOS FROM COLUMN OF THREES AND REFORM	9-26
9-9	COLUMN OF TWOS FROM COLUMN OF FOURS AND REFORM	9-28
9-10	COLUMN OF FILES FROM COLUMN OF THREES AND REFORM	9-30

MARINE CORPS DRILL AND CEREMONIES MANUAL

PART I: DRILL

CHAPTER 9

PLATOON DRILL

9000. GENERAL

1. The first phase of drill has been explained in earlier chapters of this Manual. This Chapter discusses the next phase, platoon drill. In platoon drill, the squad is merged with other squads into a platoon.
2. A platoon consists of a platoon headquarters and two or more squads or sections. Platoon headquarters consists at a minimum of a platoon commander, a platoon sergeant and a platoon guide. One or more assistants may be designated.
3. A section normally forms and drills as part of a platoon. In this Manual, the instructions given for the squad or platoon also apply to a section. A section, not subdivided into squads, forms and drills as a squad. A section that is divided into two or more squads forms and drills as a platoon.
4. Squads in a platoon are numbered from front to rear in column (when facing the front of the column) and from right to left in line.
5. The platoon forms in two or more ranks with a 40-inch distance between ranks. Movements in this Section are described for columns of threes or fours and may be executed by either formation.
6. The platoon changes interval while in line and counts off in the same manner as the squad. Squad leaders are the base for these movements. The guide moves to the right when interval is taken to the left, and does not count off.
7. In platoon drill, if all members of the platoon are to execute a movement simultaneously, the movement is executed on the command of the platoon commander. In this case, squad leaders do not repeat or give any commands. When squads of the platoon are to execute a movement in successive order, such as forming column of twos (files) and reforming into column (of threes, etc.), squad leaders give appropriate supplemental commands for the movement of their squads.
8. Unless specified for the platoon to be at close interval, all changes in formation should be executed with normal interval and distance between files and ranks.
9. The unit leader will march to the left and parallel to the platoon, from a position where he/she can best control the unit.
10. All commands given by the unit leader while the platoon is halted will be 6 paces in front of the unit and centered on the element.

9001. FORMATIONS

1. Column and line are the two formations for a platoon. (See figures 9-1 and 9-2.)

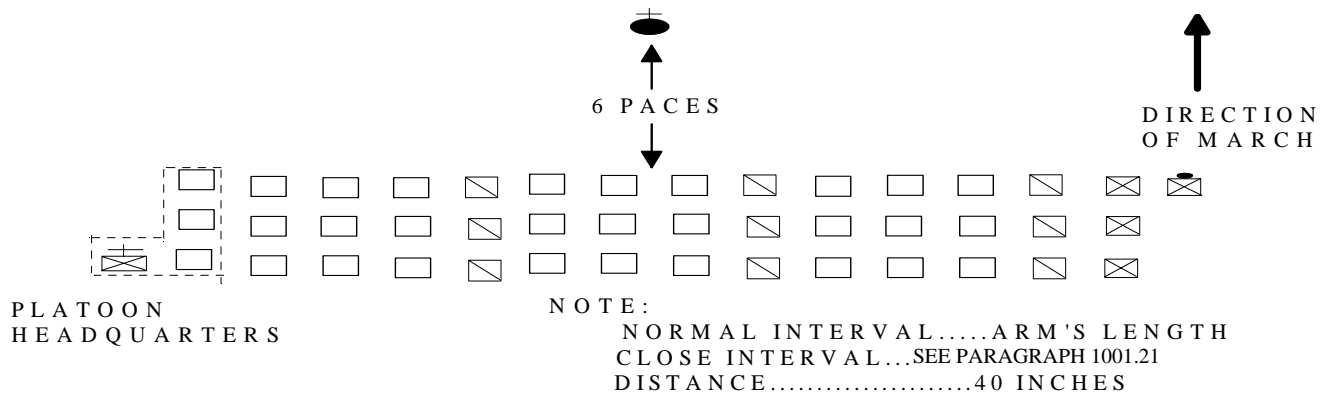

Figure 9-1.--Platoon in Line at Normal Interval.

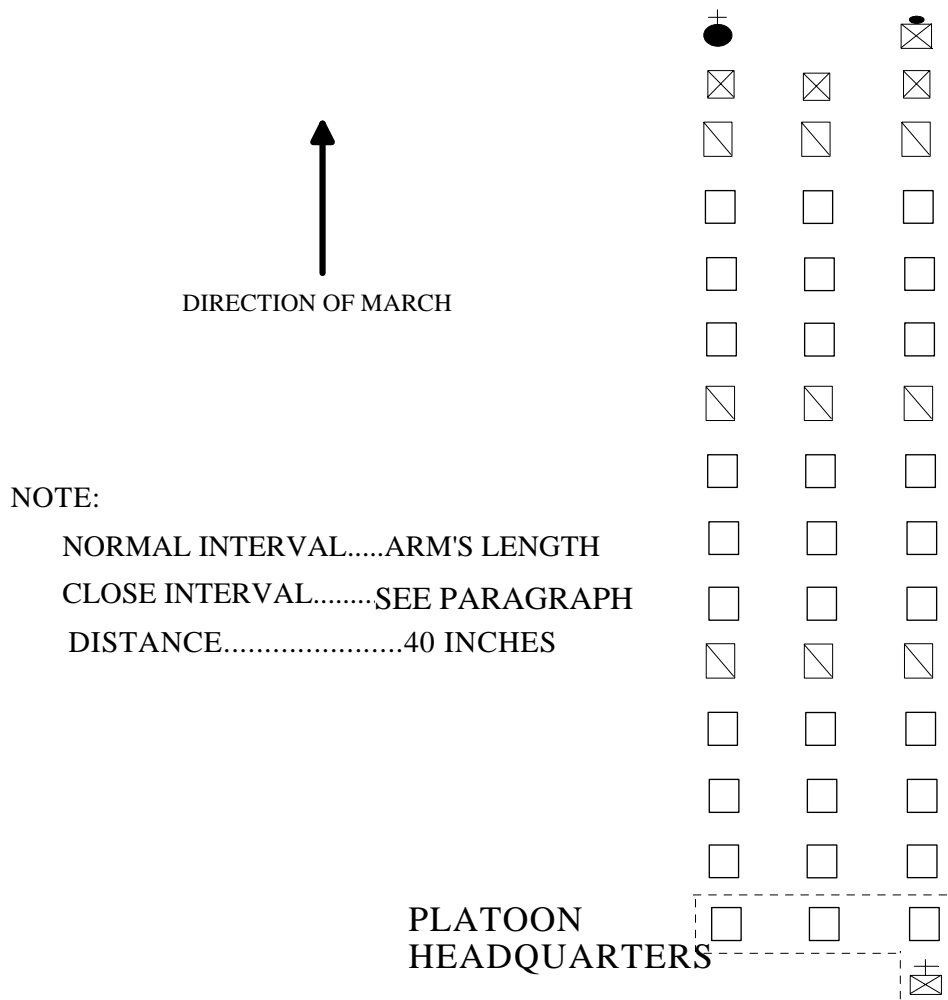

Figure 9-2.--Platoon in Column at Normal Interval.

2. The platoon normally forms in line with the squad leaders on the right of their squads and the guide on the right of the first squad leader. (See figure 9-1.) The platoon marches in line for short distances only. The platoon is normally marched in column with the squad leaders in front of their squads and the guide in front of the third (right) squad leader. (See figure 9-2.)

9002. POSTS OF INDIVIDUALS

1. In line, the platoon commander's post is 6 paces in front of the center of the front rank of the platoon. (See figure 9-1.) In column, the platoon commander marches at the head of the left file of the platoon (see figure 9-2), unless drilling the platoon, in which case he/she would maintain a position 6 paces from the platoon.

2. When the platoon commander is present, the platoon sergeant takes post to the left of the left member of the rear rank when the platoon is in line. When in column, the platoon sergeant follows the last member of the right file (squad). When the platoon commander is not present, the platoon sergeant takes the platoon commander's post and drills the platoon in the manner prescribed for the platoon commander.

3. The platoon guide takes post as stated in paragraph 9003.

4. Extra members may fall in on the left when the platoon is in line and in the rear when in column. If the squads are evenly filled, the first extra member falls in with the first squad, the second with the third (fourth) squad and then remaining squads. The platoon sergeant will reposition when necessary so as to remain the last person in the last rank.

5. In this Chapter the term "platoon commander," e.g., the platoon commander then checks the alignment, means the individual drilling the platoon. He/she may be the platoon leader, platoon sergeant, or platoon member drilling the platoon for an inspection or evaluation. Except when marching at the head of a platoon column, the platoon commander must maintain proper distance (6 paces) from the platoon and remain centered on the platoon during all drill movements.

a. If the platoon were executing a right step, the platoon commander, who is facing the platoon, would execute a left step in cadence with the platoon in order to maintain proper position. For a left step the platoon commander would execute a right step.

b. If the platoon were executing a back step, the platoon commander would execute a half step, in cadence with the platoon in order to maintain proper position.

c. Movements of the platoon commander during other platoon movements are explained in the paragraph describing the movement.

9003. RULES FOR THE GUIDE

1. Unless otherwise directed, guide is right and the platoon guide takes post on the right. In line, the guide is posted to the right of the squad leader of the first squad. In column, the guide is posted in front of the squad leader of the third or right squad.

2. In column, when it is desired to guide left or center, the command "**GUIDE LEFT**" is given. At this command, the guide and the platoon commander exchange positions. The guide crosses between the platoon commander and the platoon. To return the guide to normal position, "**GUIDE RIGHT**" is commanded. The guide and platoon commander return to their normal positions with the guide again passing between the platoon commander and the platoon. This movement may be made at a halt or while marching. The base squad or file is the one behind the guide.
3. The guide does not change position at the command "**Dress Left, DRESS.**"
4. When a platoon in line is given the command "**Right, FACE,**" the platoon guide executes right face with the platoon. The guide then faces to the right in marching, moves to a position in front of the right squad leader, halts, and executes left face. If a platoon in line is given "**Left, FACE,**" the guide executes left face with the platoon but does not change position within the platoon.
5. When a platoon in column is given the command "**Column of Files from the Left,**" the guide takes position in front of the left squad leader so as to remain at the head of the column.
6. When a platoon in column is given the command "**Column of Twos from the Left,**" the guide takes position in front of the second squad so as to remain at the head of the right file of the column. These movements are executed by facing left as in marching, moving to the appropriate position, halting, and facing right.
7. When reforming in a column of threes or fours from a column of files or twos, the guide takes post at his normal position when the movement is completed.
8. The guide sets the direction and cadence of the march. The leading member of each file is responsible for interval.
9. When a platoon is marching in column and the command "**By the Right (Left) Flank, MARCH**" or "**To the Rear, MARCH**" is given, the guide executes the movement with the platoon but does not change relative position except during specific movements of company drill. (See paragraph 10011 for an exception.)
10. The guide does not count off.

9004. TO FORM THE PLATOON

1. The platoon forms in line at normal interval and distance between files and ranks (see figure 9-1) on the command "**FALL IN.**" To form at close interval, the command is "**At Close Interval, FALL IN,**" in which case the platoon forms in line with normal distance between ranks, but with close interval between files. The platoon sergeant or platoon commander forms the platoon as described below.
2. Forming the Platoon by the Platoon Sergeant
 - a. The platoon sergeant takes post 3 paces in front of the point where the center of the platoon will be, faces that point, draws sword if so armed, and commands either "**FALL IN**" or "**At Close Interval, FALL IN.**" At this command, the guide takes post so that the first rank, when aligned on the guide will be centered on and 3 paces from the platoon sergeant. The squad leader of the first squad

falls in to the left of the guide and aligns at normal or close interval. Other squad leaders fall in directly behind the squad leader of the first squad with 40 inches distance between them. The members of the squads fall in and align on their squad leaders at normal or close interval as prescribed in squad drill, except that exact interval is measured only by the front rank. Individuals in the rear ranks gain their interval by covering the corresponding member of the rank in front of them. All personnel fall in at attention and, if armed with the rifle, at the position of order arms.

b. When a report is appropriate, after all personnel are formed, the platoon sergeant commands, "**REPORT.**" Remaining in position (at order arms if armed with the rifle), the squad leaders, in sequence from front to rear, salute and report, "All present" or "(Rank and Name) absent." If the troops are armed, the platoon sergeant commands, "**Inspection, ARMS;**" "**Port, ARMS;**" and "**Order, ARMS.**" The platoon sergeant then executes about face. (NOTE: If the platoon cannot be formed in regularly organized squads prior to forming the platoon, the platoon sergeant commands "**Inspection, ARMS;**" "**Port, ARMS;**" "**Right Shoulder, ARMS;**" and calls the roll. Each Marine answers "here," and goes to order arms as their name is called. The platoon sergeant then organizes the platoon into squads and faces the front. The manual of arms is omitted for personnel not armed with rifles.)

c. To receive the platoon, the platoon commander takes post 3 paces in front of the platoon sergeant (sword in scabbard if so armed), the platoon sergeant salutes and reports, "Sir (Ma'am), all present or accounted for" or "Sir (Ma'am), (number) absent." The platoon commander returns the salute and may discuss absentees and issue necessary instructions to the platoon sergeant. The platoon commander then commands the platoon sergeant, "**TAKE YOUR POST.**" The platoon sergeant marches by the most direct route to a post on the left of the rear rank. The platoon commander then draws sword, if so armed.

d. If the platoon commander does not receive the platoon, the platoon sergeant takes 3 paces forward, faces about and assumes the post and duties of the platoon commander.

3. Forming the Platoon by the Platoon Commander

a. When appropriate, the platoon may be formed by the platoon commander rather than the platoon sergeant. The procedures are the same except that the platoon commander takes post 6 paces in front of the point where the center of the platoon will be, faces that point, draws sword and commands "**FALL IN**" or "**At Close Interval, FALL IN.**"

b. The platoon forms on the platoon commander, the platoon sergeant falling in on the left of the rear rank with sword drawn, if so armed. The platoon commander then receives the report from the squad leaders and causes the platoon to execute inspection arms if the troops are armed.

9005. TO DISMISS THE PLATOON

1. The platoon is dismissed only from in line while at attention.
2. Armed troops are dismissed with the commands "**Inspection, ARMS;**" "**Port, ARMS;**" and "**DISMISSED.**"
3. Unarmed troops are dismissed with the command "**DISMISSED.**"

4. The platoon sergeant usually dismisses the platoon.

9006. COUNT OFF

1. The purpose of this movement is to designate the relative position in ranks of each member of the platoon. It may be executed when the platoon is halted at attention in line or column. When in line the command is **"Count, OFF;"** when in column the command is **"From Front to Rear, Count, OFF."**

2. In line, on the command **"Count, OFF,"** everyone except the guide and squad leaders turn their heads 90 degrees to the right and look to the right. The squad leaders shout ONE. The persons in the file to the left of the squad leaders turn their heads smartly back to the front and at the same time shout TWO. After the file to their right has shouted its number, each subsequent file to the left turn their heads back to the front and shouts the next higher number. Numbers are counted off in quick time cadence.

3. In column, on the command **"From Front to Rear, Count, OFF,"** the squad leaders smartly turn their heads to the right and shout ONE as they return their heads back to the front. Each subsequent rank, having seen the heads in front of them return to the front, turn their heads to the right and shout the next higher number as they bring their heads smartly back to the front. This is carried on in sequence at quick time cadence. The guide does not turn his/her head nor count off. The platoon commander gives the command from a position 6 paces in front and centered on the squad leaders.

9007. TO FORM COLUMN FROM LINE. The purpose of this movement is to change the formation from line to column. It may be executed only when halted at normal interval, at attention, and at order arms if armed with rifles. The command is **"Right, FACE."** On the command of execution **"FACE,"** all members of the platoon face to the right, thereby forming column. The guide moves to his/her position in front of the right squad leader. The platoon commander may then command any halted movement from his/her current position, (e.g., right/left shoulder, port, sling, arms; facing movements, right/left step; etc.) unless otherwise indicated in this Chapter. If the platoon is to march as part of a larger formation the platoon commander takes post in front of the left file and the guide in front of the right file. (See figure 9-2.) From this position the platoon commander would command **"Forward (Column Right {Left}), MARCH"** to cause the platoon to march in column. (NOTE: Since the platoon becomes inverted if faced to the left, this should only be done for short adjusting movements. To properly form column facing to the left, the platoon should first form column by facing to the right, then execute successive column movements until the column is faced in the desired direction.)

9008. TO FORM LINE FROM COLUMN. The purpose of this movement is to change the formation from a column back to a line. It may be executed when halted at attention and at order arms if armed with rifles. The command is **"Left, FACE."** (NOTE: If the platoon is in column at close interval they must be extended to normal interval, paragraph 9015, prior to executing left face. Otherwise there will not be 40 inches distance between ranks.) At the command of execution **"FACE,"** all members of the platoon face to the left, the platoon commander, if necessary, moves by the most direct route to a post 6 paces front and center of the platoon, and the platoon guide takes post on the right of the front rank. (NOTE: When in column, if the platoon is faced to the right it becomes inverted. This should only be done for short adjusting movements.)

9009. TO ALIGN THE PLATOON

1. The purpose of these movements is to dress the alignment of the platoon. They may be executed when the platoon is halted at attention in line or column. When in line, the commands are **"Dress Right (Left), DRESS"** or **"At Close Interval, Dress Right (Left), DRESS."** These commands are given only when the platoon is at approximately the same interval as the interval at which the dress is commanded. When in column, halted or marching, the command to dress alignment is **"COVER."**

2. Dress Right Dress

a. On the command **"Dress Right, DRESS,"** everyone except those individuals on the right flank, smartly turn their heads to the right, look, and align themselves. At the same time, everyone except those individuals on the left flank, provide interval by smartly raising their extended left arm to shoulder height and in line with their body. Fingers are extended and joined, thumb along the forefinger, palm down.

b. As the base of the movement, the guide stands fast and remains looking to the front. The first squad leader looks to the right and aligns on the guide. The other squad leaders cover the first squad leader and look to the front, ensuring they have a 40-inch distance. All other members position themselves by short steps until their right shoulders touch the fingertips of the person on their right.

c. The platoon commander, on his/her own command of execution **"DRESS,"** faces half left, as in marching, and proceeds by the most direct route to a position on line with the front rank and 1 pace to the guide's right (or first squad leader if there is no guide). (See figure 9-3a.) At this position, the platoon commander executes a halt while facing rear, and then executes a right face, facing down the line of the first rank. (See figure 9-3b.) The platoon commander aligns the front rank by commanding those individuals in advance or rear of the line to move forward or backward until in line. These individuals are designated by name or number. For example: **"Jones, FORWARD;"** or **"Number Three, BACKWARDS."** Those commanded to move will move the designated number of steps or will continue to move (taking small steps) until receiving the command **"STEADY."** The commander may execute a series of short side steps to the right or left in order to identify an individual. However, prior to commanding the identified individual to move, the commander will be on line with the rank. After verifying the alignment of the first rank, the platoon commander faces to the left as in marching, and moves to a position on line with the next rank. The 1 pace interval from the guide is maintained (this results in a 2 pace interval from the second and subsequent squad leaders). The commander halts on line with each succeeding rank, executes right face, and aligns the rank. (See figures 9-3c and d.) After verifying the alignment of the last rank, the platoon commander faces to the right in marching, marches straight to a point 3 paces beyond the front rank, maintaining the 1 pace interval to the guide's right, halts, (see figure 9-3e) faces to the left, (see figure 9-3f) and commands **"Ready, FRONT"** and **"COVER."** Immediately after commanding, **"COVER,"** the platoon commander marches by the most direct route back to a post 6 paces front and centered on the platoon, halts facing down line or to the front.

d. On the command **"Ready, FRONT,"** all members of the platoon who raised their left arm and turned their head to the right, will smartly but quietly lower their arm to their side and at the same time turn their head back to the front, assuming the position of attention. On the command **"COVER,"** all members of the second and subsequent ranks will cover on the individual in front of them.

e. When aligning a platoon of well-drilled troops or when there is insufficient time to verify alignment, the platoon commander may command **"Ready, FRONT"** and **"COVER"** from his/her normal position (6 paces front and centered), without having verified alignment.

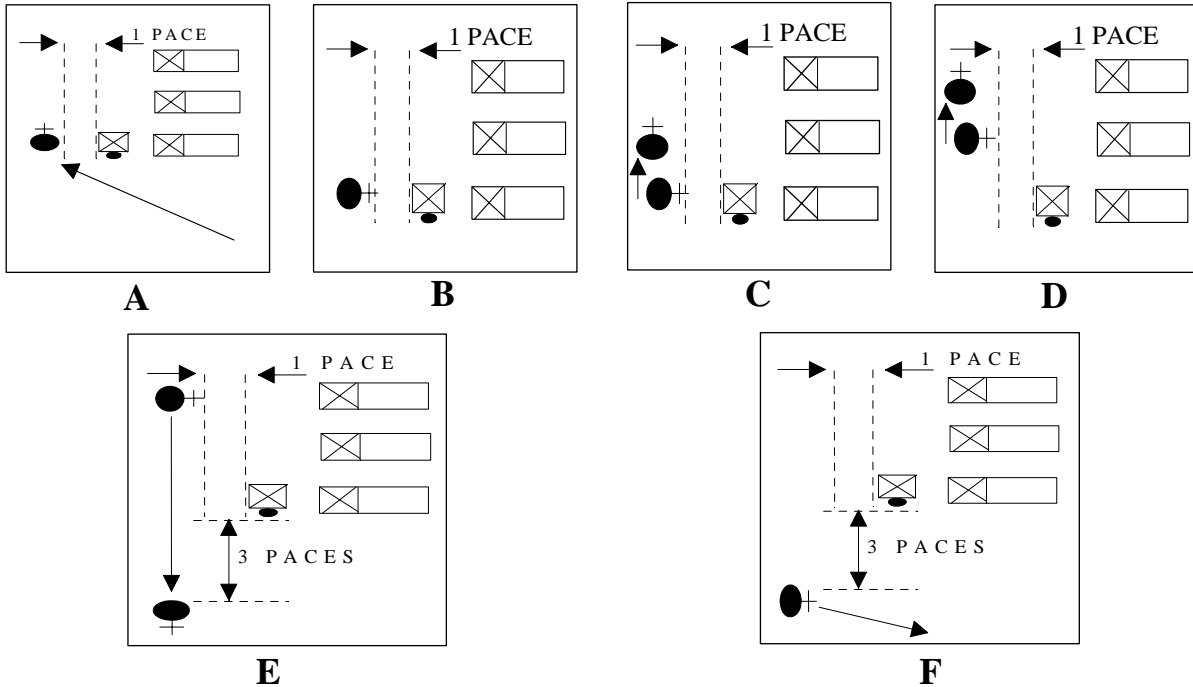

Figure 9-3.--Movements of the Platoon Commander when Aligning the Platoon.

3. At Close Interval Dress Right Dress. This movement is executed in the same manner as dress right dress except for the following: On the command **"At Close Interval, Dress Right, DRESS,"** those individuals providing interval will do so by placing the heel of their left hand on their hip with the elbow in line with their body. Fingers are extended and joined and pointing down. Members gaining interval will move by short steps until their right arm is touching the left elbow of the individual to their right.

4. Dress Left Dress and at Close Interval Dress Left Dress. These movements are similar to dress right dress and at close interval dress right dress except that alignment is made toward the left. The last individual in the first rank is the base of the movement and stands fast. On the command **"Dress Left, DRESS"** or **"At Close Interval, Dress Left, DRESS,"** everyone except those on the left flank smartly turn their heads to the left, look, and align themselves. At the same time they will smartly raise their left arm or elbow to provide interval (the left arm is used for both dress right and dress left). The last individuals in the second and subsequent ranks will cover the person in front of them and ensure that they have a 40-inch distance. The platoon commander will verify alignment of the platoon from its left flank.

5. Aligning in Column

a. The base squad for maintaining alignment while halted or marching in column is normally the third (right) squad. However, when executing a column left, column half left or eyes left alignment is to the first (left) squad. While marching, alignment is maintained by constantly glancing out of the corner of the right (left) eye, without turning the head.

b. Halted. When halted in column, (except for parades and ceremonies) the platoon is aligned by the command "COVER." At the command, the base squad leader obtains a 40-inch distance from the guide and covers on him/her. Other squad leaders obtain proper interval from the base squad leader and align toward the base by glancing out of the corner of their right (left) eye without turning their heads. Other members of the base squad obtain a 40-inch distance and covers on the person in front of them. At the same time, the remaining members of the platoon align on the base squad, by glancing out of the corner of their right (left) eye without turning the head and covers on the person in front of them. Only small adjusting steps are taken by platoon members to gain cover and alignment.

c. Marching. While marching, cover and alignment are constantly maintained by glancing out of the corner of the right (left) eye, without turning the head, to align on the base squad. The command of "COVER" is only given if required.

9010. TO OBTAIN CLOSE INTERVAL FROM NORMAL INTERVAL IN LINE

1. The purpose of this movement is to close the interval between files of a platoon in line to 4 inches. It may be executed when the platoon is halted at attention and in line at normal interval. The command is "**Close, MARCH.**"

2. The squad leaders are the base of this movement. On the command of execution "**MARCH,**" the squad leaders stand fast and place their left hand on their hip to provide interval for the individuals to their left. At the same time, all other members of the platoon, except for the guide, face to the right as in marching, march toward the right flank until approximately 4 inches from the person in front of them, halt, and face to the left. They then execute at close interval dress right dress. After aligning and without command, they will smartly lower their left hands and turn their heads to the front as soon as the individual to their left has touched their elbow with his/her right arm and stopped moving. Cover is then obtained without command.

3. On the command of execution, the guide will step to the left as in marching and close to 4 inches on the first squad leader. After halting and facing to the right, the guide will execute at close interval dress left dress. When aligned and at the proper interval the guide will return to the position of attention.

4. The platoon commander on his/her own command of execution "**MARCH**" will step to the left in marching. He/she marches parallel to the platoon maintaining a distance of 6 paces from the platoon. When approximately on the center of the platoon at close interval the platoon commander halts and faces the platoon. The platoon commander then adjusts to the center of the platoon by taking small steps left, right, forward or back.

9011. TO OBTAIN NORMAL INTERVAL FROM CLOSE INTERVAL IN LINE

1. The purpose of this movement is to extend the interval between files of a platoon in line to one arm length. It may be executed when the platoon is halted at attention and in line at close interval. The command is **"Extend, MARCH."**
2. The squad leaders are the base of this movement. On the command of execution **"MARCH,"** the squad leaders stand fast and raise their left arms to shoulder height to provide interval for the persons on their left. At the same time, all other members of the platoon, except for the guide, face to the left as in marching, march toward the left flank until they have opened approximately a 30-inch distance from the person behind them, halt, and face to the right. They then execute dress right dress. After aligning and without command, they will smartly lower their left arms and turn their heads to the front as soon as the individual to their left has touched their finger tips with his/her right shoulder and stopped moving. Cover is then obtained without command.
3. On the command of execution, the guide will take one step to the right as in marching, halt and face to the left. The guide will then execute dress left dress. When aligned on the first squad leader and at the proper interval the guide will return to the position of attention.
4. The platoon commander on his/her own command of execution **"MARCH"** will step to the right in marching. He/she marches parallel to the platoon maintaining a distance of 6 paces from the platoon. When approximately on the center of the platoon at normal interval the platoon commander halts and faces the platoon. The platoon commander then adjusts to the center of the platoon by taking small steps left, right, forward or back.

9012. TO OBTAIN DOUBLE ARM INTERVAL IN LINE

1. The purpose of this movement is to extend the interval between the files of a platoon to a double arm distance. It may be executed when the platoon is halted at attention and in line at normal or close interval. If armed, rifles must be at sling arms. The command is **"Take Interval to the Left, MARCH."**
2. The squad leaders are the base of this movement. On the command of execution **"MARCH,"** the squad leaders stand fast and raise their left arms to shoulder height, to provide interval for the persons on their left. The first squad leader will also raise his/her right arm to provide interval for the guide. At the same time, all other members of the platoon, except for the guide, face to the left as in marching, march toward the left flank until they have opened approximately a 70-inch distance from the person behind them, halt, and face to the right. They then smartly turn their heads to the right and raise both arms to shoulder height. Individuals on the left flank will only raise their right arm. After aligning and without command, they will smartly lower their right arms and turn their heads to the front as soon as they have proper interval. They will lower their left arms when they feel the individual to their left lower his/her right arm. Cover is then obtained without command.
3. On the command of execution, the guide will take two steps to the right as in marching, halt and face to the left. The guide will then execute dress left dress. When aligned on the first squad leader and at the proper interval, the guide will return to the position of attention. When the first squad leader feels the guide lower his/her left arm, the squad leader will lower his/her right arm.

4. The platoon commander on his/her own command of execution **"MARCH"** will step to the right in marching. He/she marches parallel to the platoon maintaining a distance of 6 paces from the platoon. When approximately on the center of the platoon at double arm interval the platoon commander halts and faces the platoon. The platoon commander then adjusts to the center of the platoon by taking small steps left, right, forward or back.

9013. TO OBTAIN NORMAL INTERVAL FROM DOUBLE ARM INTERVAL

1. The purpose of this movement is to decrease the interval between files of a platoon in line from double arm to normal interval. It can only be executed when the platoon is halted at attention and in line at a double arm interval. The command is **"Assemble to the Right, MARCH."** On the command of execution, the interval is reduced in a manner similar to close march; except that individuals halt approximately 30 inches from each other, face and execute the appropriate dress movement to obtain normal interval.

2. The platoon commander on his/her own command of execution **"MARCH"** will step to the left in marching. He/she marches parallel to the platoon maintaining a distance of 6 paces from the platoon. When approximately on the center of the platoon at normal interval the platoon commander halts and faces the platoon. The platoon commander then adjusts to the center of the platoon by taking small steps left, right, forward or back.

9014. TO OBTAIN CLOSE INTERVAL IN COLUMN

1. The purpose of this movement is to close the interval between files in a column to 4 inches. It may be executed when halted or marching at normal interval in column. The command is **"Close, MARCH."**

2. When halted and the guide is right, on the command **"MARCH,"** members of the base (right) squad will stand fast. Members of the squad next to the base squad will execute two right steps. The next squad to the left will execute four right steps. If there are four squads in the platoon, the first (left) squad will execute six right steps. While side stepping, cover and alignment will be maintained. Steps may be adjusted slightly so that a 4-inch interval is obtained. Upon completion of the designated number of steps, members of the squad will halt and resume the position of attention.

3. When marching and the guide is right, the command of execution **"MARCH"** is given as the right foot strikes the deck. At this command:

a. The base (right) squad takes one more 30-inch step with the left foot and then begins to half step. (See figure 9-4.)

b. The squad to the left of the base squad takes one more 30-inch step to the front with the left foot; execute right oblique toward the base squad for one step and then steps 30 inches back to the original front. The squad then begins to half step.

c. The next squad to the left takes one more 30-inch step to the front and then executes right oblique toward the base squad for three steps and steps 30 inches back to the original front. The squad then begins to half step.

d. If there are four squads in the platoon, the first (left) squad would execute the same movements as above except the members would take five steps in the oblique.

e. Steps in the oblique may be adjusted slightly so that a 4-inch interval is obtained.

f. At the command "**Forward, MARCH**" all squads resume taking 30-inch steps.

4. If the guide has been shifted to the left or center, the base squad will become the squad behind the guide. The commands of execution will be given as the left foot strikes the deck, if guide is left, or on either foot if guide is center. Side steps or oblique movements will be made toward the base squad as appropriate.

5. The platoon commander, on his/her command "**MARCH,**" oblique the number of steps necessary to remain parallel to the platoon and picks up the half step. The platoon commander picks up a full 30-inch step on his/her command of "**Forward, MARCH.**"

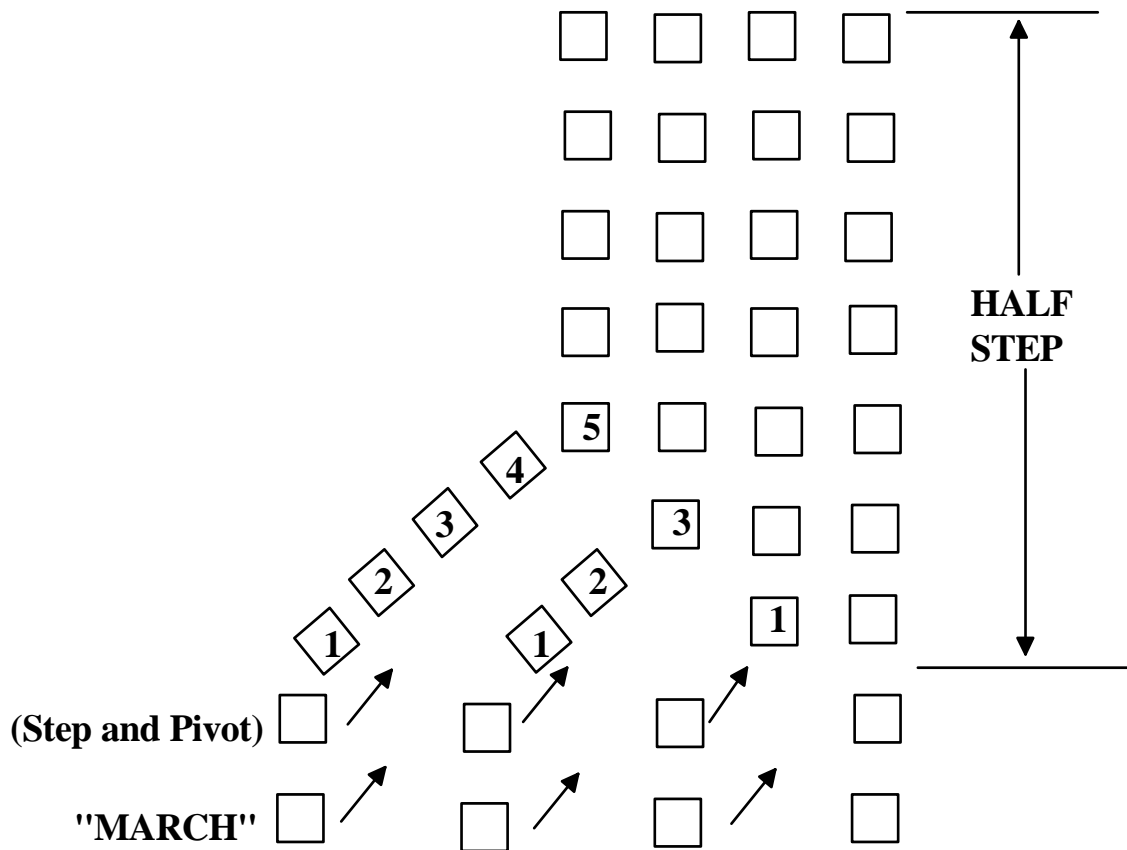

Figure 9-4.--Close March (While Marching), Right Squad Base.

9015. TO EXTEND TO NORMAL INTERVAL IN COLUMN

1. The purpose of this movement is to extend the interval between files in a column from close to normal interval. It may be executed when halted or marching in column at close interval. The command is **"Extend, MARCH."**
2. When halted and the guide is right, on the command of execution **"MARCH,"** members of the base (right) squad stand fast. Members of the squad next to the base squad will execute two left steps. The next squad to the left will execute four left steps. If there are four squads in the platoon, the first (left) squad will execute six left steps. While side stepping, cover and alignment will be maintained. Steps may be adjusted slightly so that one arms interval is obtained between squad leaders. Upon completion of the designated number of steps, members of the squad will halt and resume the position of attention.
3. When marching and the guide is right, the command of execution **"MARCH"** is given as the left foot strikes the deck. At this command:
 - a. The base (right) squad takes one more 30-inch step with the right foot and then begins to half step.
 - b. The squad next to the base squad takes one more 30-inch step to the front with the right foot, executes left oblique away from the base squad for one step and steps 30 inches back to the original front. The squad then begins to half step.
 - c. The next squad to the left takes one more 30-inch step to the front and then executes left oblique away from the base squad for three steps and steps 30 inches back to the original front. The squad then begins to half step.
 - d. If there are four squads in the platoon, the first (left) squad would execute the same movements as above except the members would take five steps in the oblique.
 - e. Steps in the oblique may be adjusted slightly so that a one-arm interval is obtained between squad leaders.
 - f. At the command **"Forward, MARCH,"** all squads resume taking 30-inch steps.
4. If the guide has been shifted to the left or center, the base squad will become the squad behind the guide. Side steps or oblique movements will then be made away from the base squad as appropriate.
5. The platoon commander, on his/her command **"MARCH,"** oblique the number of steps necessary to remain 6 paces from the platoon and picks up the half step. The platoon commander picks up a full 30-inch step on his/her command of **"Forward, MARCH."**

9016. TO OPEN RANKS

1. The purpose of this movement is to increase the distance between ranks to 70 inches in order to accommodate the movements of an inspection party or to stack arms. It may be executed when halted in line at attention, and at normal or close interval. If armed, rifles will be at order arms. The commands are **"At Close Interval, Open Rank," "MARCH;" "Ready, FRONT;"** and **"COVER."**

2. When at normal interval, on the command of execution **"MARCH,"** the front rank takes two 30-inch steps forward, halts, and executes dress right dress. The second rank takes one 30-inch step forward, halts, and executes dress right dress. The third rank stands fast and executes dress right. If there is a fourth rank, it takes two 15-inch back steps, halts, and executes dress right. When at close interval, all ranks will execute at close interval, dress right dress in place of dress right dress.

3. The platoon commander verifies alignment as for dress right dress, except that he/she will verify the 70-inch distance between ranks by taking two 30-inch steps and one 10-inch step when moving from one rank to the next. After verifying the alignment of the rear rank, he/she faces to the right in marching, marches 3 paces beyond the front rank, and 1 pace to the guide's right, halts, faces to the left, and commands **"Ready, FRONT"** and **"COVER."** The platoon responds to these commands in the same manner as when they are given following dress right dress.

a. If the platoon is about to be inspected the platoon commander, after the command **"COVER"** will take one step to the front so that he/she is 3 paces directly in front of the guide, and then execute a right face. From this position the platoon commander reports the platoon to the inspecting officer.

b. If the platoon is to stack arms, the platoon commander, on his/her command **"COVER"** will return by the most direct route to post 6 paces and centered in front of the platoon. The commands for stack arms would then be given, paragraph 9018.

9017. TO CLOSE RANKS

1. The purpose of this movement is to decrease the distance between opened ranks to a normal distance (40 inches). It may only be given when the platoon is at attention at open ranks. The command is **"Close Ranks, MARCH."** It should be given immediately after the reason for opening ranks is accomplished, and before the platoon is given further drill movements or dismissed.

2. On the command of execution **"MARCH,"** the front rank stands fast while the second rank takes one 30-inch step to the front and halts. At the same time, the third rank takes two 30-inch steps to the front and if there is a fourth squad, it takes 3 steps and halts. Each individual maintains cover and alignment while moving. No dressing movements are executed.

3. The platoon commander may give the command to close ranks when:

a. After the platoon is inspected, the platoon commander returns to a position 3 paces in front of the guide and halts facing to the front. It is from this position that the inspecting officer would critique the inspection. The platoon commander would exchange salutes with the inspection officer and after that officer has departed, the platoon commander would face to the left and then command **"Close Ranks, MARCH."** The platoon commander, on the command **"MARCH,"** then moves to his/her position 6 paces and centered on the platoon.

b. After the platoon has taken arms, paragraph 9019, the platoon commander would command, **"Close Ranks, MARCH"** from his/her position 6 paces and centered in front of the platoon.

9018. TO STACK ARMS

1. The purpose of this movement is to temporarily relieve the platoon of its weapons. It may be executed when the platoon is halted in line. The command is **"Stack, ARMS;"** however, this command must be preceded by preliminary commands in order to prepare the platoon to stack arms. Assuming the platoon is halted in line at normal interval, the sequence of commands will be **"Count, OFF," "NUMBERS 3, 7, AND 11 ARE STACKMEN;" "Prepare, SLINGS;" "Open Ranks, MARCH;" "Ready, FRONT;" "COVER;"** and then **"Stack, ARMS."**

2. On the command **"Count, OFF,"** the platoon counts off as prescribed in paragraph 9006.

3. Stackmen are designated by file number with the command, **"NUMBERS 3, 7, AND 11 ARE STACKMEN."** In other words the number 3, 7, and 11 persons in each squad are designated as stackmen. Additional stackmen may be designated if the platoon has enough additional rifles to warrant it. The numbers 3, 7, and 11 are used to preserve fire team integrity for each weapons stack. If the squads are not divided into fire teams, numbers 2, 5, 8, and 11 may be designated stackmen. This reduces the number of extra weapons that must be added to the stacks.

4. On the command **"Prepare, SLINGS,"** the designated stackmen place the butt of their rifles on their right hip and cradle them in the crook of their right arm. They then adjust their slings to form a 4-inch loop next to the upper sling swivel with the sling on the left side. As soon as they have prepared the loop, they return to order arms.

5. When all stackmen have returned to order arms the platoon commander commands **"Open Ranks, MARCH,"** and ranks are opened as prescribed in paragraph 9016. After the platoon is aligned the platoon commander commands, **"Ready, FRONT"** and **"COVER."** He/she then moves to his/her position 6 paces and centered on the platoon prior to giving the next command.

6. On the command **"Stack, ARMS,"** the designated stackmen place their weapons directly in front of and centered on their bodies with the sights to the rear. The heel of the rifle butt is placed on the ground on line with the toes of their shoes. Each stacker grasps the rifle at the upper portion of the handguard with the left hand, keeping the rifle vertical. The first two fingers of the left hand hold the inner part of the loop against the rifle. The stacker reaches across the front of the rifle with the right hand, grasps the outer part of the loop and holds it open for insertion of the rifles. (See figure 8-9.) At the same time, the individuals to the left and right of the stackmen perform the following movements simultaneously:

a. The individuals on the stackmen's right raise and center their weapons by bringing their right wrists to shoulder height and centered on their bodies, magazine wells face the front. They then grasp the handguards (midway) with their left hands, release their right hand and re-grasp the weapon at the small of the stock. Arms are then lowered to a dead hang, so that the weapons are held in a horizontal position with the muzzles to the left and magazine wells still to the front. (See figure 8-9.)

b. The individuals on the stackmen's left raise and center their weapons by bringing their right wrists to shoulder height and centered on their bodies, magazine wells face the front. They then grasp their weapons at the small of the

stock with their left hands, release their right hands and re-grasp the handguards (midway). Arms are lowered to a dead hang so that the weapons are held in a horizontal position with the muzzles to the right and the magazine wells still to the front. (See figure 8-9.)

c. As soon as the stackmen have placed their rifles in position, both the individuals to the right and left move their feet 18 inches in the oblique toward the stackmen. The individuals on the stacker's left insert the muzzles of their rifles into the loops to a point approximately halfway between the compensator and the front sight. They hold their weapons in this position until the individuals on the stacker's right insert the muzzles of their rifles in a similar manner but above the other rifle in each loop. (See figure 8-10.)

d. The butts of the rifles inserted into the loops are swung outward and down to the ground until the stacks are tight with the rifle butts on line and approximately 2 feet forward of the stackmen's rifles. The rifles rest on the side of the butts with the pistol grips pointing inboard toward each other. As each stack is completed, all three individuals stand up at the same time and resume the position of attention. (See figure 8-11.)

e. Extra rifles are passed to the nearest stacks on the right. Individuals holding extra rifles grasp the barrels of their rifles, raise them vertically and then extend their right arms horizontally to the right front. The persons to the right grasp the weapons at the handguard, center them on their bodies, grasp the barrels with their right hands and extend their right arms horizontally to the right front. This action is repeated until the rifles reach the stackmen. The stackmen lean the rifles against the stacks in such a manner as to prevent them from falling or knocking the stacks over.

f. If the numbers 3, 7, and 11 were stackmen, the squad leaders would then pass their rifles to the stacker. The squad leaders pass their rifles to the first stack on the left by raising the weapon with the right hand to a position centered on the body. They then grasp the weapon with the left hand at the handguards and pass the weapon the left by extending the left arm horizontally to the left front. The individual to the squad leader's left then grasps the rifle at the barrel with the right hand, centers it on the body, grasps the handguards with the left hand and passes it to the stacker.

g. After the squad leader of the front rank has passed his/her weapon, the guide would then pass his/her weapon to the stacker in the same manner as the squad leaders.

9019. TO TAKE ARMS

1. The purpose of this movement is to recover arms that have been stacked. It may be executed only when the platoon has fallen back in on the weapons stacks. The command is **"Take, ARMS."**

2. On the command of execution **"ARMS,"** if there are extra arms they are passed back in a reverse order and manner of the way they were passed to the stacks. When extra arms have been passed back, or if there were no extra arms, the stackmen grasp their rifles and hold the loops in the same manner as was done for stacking arms. The individuals to the left and right step in the oblique, reach down and

re-grasp their weapons and bring them to a horizontal position. Weapons are freed from the loops, individuals on the right first, and order or unsling arms is assumed. Stackmen cradle their rifles and adjust slings to their original position and then assume the order or unsling arms position.

3. Once everyone is at the position of order or unsling arms, the command **"Close Ranks, MARCH"** is given.

9020. TO FORM FOR PHYSICAL DRILL

1. The purpose of the movement is to form the platoon for physical exercise. It may be executed when the platoon is halted at attention and in a column of threes or fours at normal interval. If armed with rifles, they will be at order arms. The sequence of commands are: **"From Front to Rear, Count, OFF;" "Take Interval to the Left, MARCH;" "Arms, DOWN;"** and **"Even Numbers, To the Right, MOVE."** To reform to a column the commands are **"Assemble, MARCH"** and **"COVER."**

2. The command **"From Front to Rear, Count, OFF"** is given by the platoon commander in order to designate odd and even ranks. It is executed as prescribed for counting off in column.

3. The next command is **"Take Interval to the Left, MARCH."** This movement is different from the movement described in paragraph 9012, which is executed when the platoon is in line formation. With the platoon in column, the extended interval is set by designating the number of steps the members of each squad take to the left.

a. On the command of execution **"MARCH,"** all members of the squad on the right flank (third squad if it is a three squad platoon, fourth squad if it is a four squad platoon) and the guide, will cover in file, stand fast and each member extends both arms sideways at shoulder height, palms down with fingers extended and joined. If armed with rifles each member will grasp the barrel of the rifle with the right hand and raise it to shoulder height with the pistol grip and magazine well facing the front. This squad forms the base of the movement.

b. At the same time, the members of each squad to the left of the base squad will face to the left as in marching and take two, four, or six (if it is a four squad platoon) 30-inch steps respectively. Upon completing their designated number of steps, they will halt, execute a right face, will cover in file, stand fast, and extend their arms to the side at shoulder height in the same manner as the right file. If armed with rifles the rifles are carried at trail arms during movement and then raised in the same manner as the right file.

c. At the command **"Arms, DOWN,"** the arms are lowered smartly to the side and if armed with rifles the position of order arms is assumed.

4. On the command **"Even Numbers to the Right, MOVE,"** all even numbered individuals and the guide will move to their right to the middle of the interval between files. This will be done by swinging the right leg to the right and springing off the left foot. The movement should be completed in one hop. If armed with rifles the weapon is brought to trail arms and held against the right leg during movement. Once in position, even numbered members cover and assume the position of attention. Odd numbered members do not move. From this position physical drill may be executed without the danger of collisions between individuals.

5. Upon the completion of physical drill, the command **"Assemble, MARCH"** is given. On the command of execution, the odd numbered members of the base squad stand fast. Even numbered members of the base squad step left in marching and double time to their positions covered on the odd numbered members of the base squad and the guide will return to a position in front of the base squad leader. At the same time, all other members will face right as in marching and, at a double time cadence, reassemble in column at normal interval and stand fast. The platoon commander would then give the command of **"COVER"** in order for the platoon to quickly pick up its alignment and cover.

6. The platoon commander, once the platoon is in column, gives all commands from a position 6 paces in front of, centered on and facing the column. He/she makes those movements necessary to maintain this position during the execution of the movement(s).

9021. TO CHANGE THE DIRECTION OF A COLUMN

1. The purpose of this movement is to change the direction of march of a column. It may be executed when the platoon is halted or marching in column at normal or close interval. The command is **"Column Right (Column Left, Column Half Right or Column Half Left), MARCH."** The base element during the turn is the squad on the flank in the direction of the turn. The leading member of the base squad, excluding the platoon commander and guide, establishes the pivot for the movement.

2. When marching, the commands of execution are given on the foot in the direction of the turn. On the command of execution **"MARCH,"** the leading member of the base squad takes one more 30-inch step to the front and then pivots 90 degrees to the right (left) on the ball of the left (right) foot. He/she then takes one 30-inch step in the new direction before beginning to half step. At the same time other members of the leading rank execute a right (left) oblique. They step in this direction until they are on line with the new line of march (normally two, four and six steps respectively) and then execute a second right (left) oblique. The original interval is maintained while in the oblique. Stepping out of the second oblique with a 30-inch step, they begin to half step as soon as they are aligned on the base squad leader. When all members of the same rank have come abreast, everyone in that rank resumes a full step. Ranks in rear of the leading rank execute the pivot movements on the same points and in the same way as the leading rank. (See figure 9-5.)

3. When halted, at the command of execution **"MARCH,"** the leading member of the base squad faces to the right (left) as in marching and takes one 30-inch step in the new direction with the right (left) foot. At the same time other members of the leading rank step off in the right (left) oblique. Members behind the lead rank step off to the front as in forward march. The remainder of the movement is executed the same as in marching.

4. During column movements, the platoon commander and guide execute either an oblique or a 90-degree pivot (depending on the direction of the movement) on the command of execution. After completing their turn, they adjust their line of march so that they are in front of the appropriate squad.

5. For slight changes of direction, the command is **"INCLINE TO THE RIGHT (LEFT)."** At that command, the guide changes direction as commanded. This is not a precision movement and is executed only while marching.

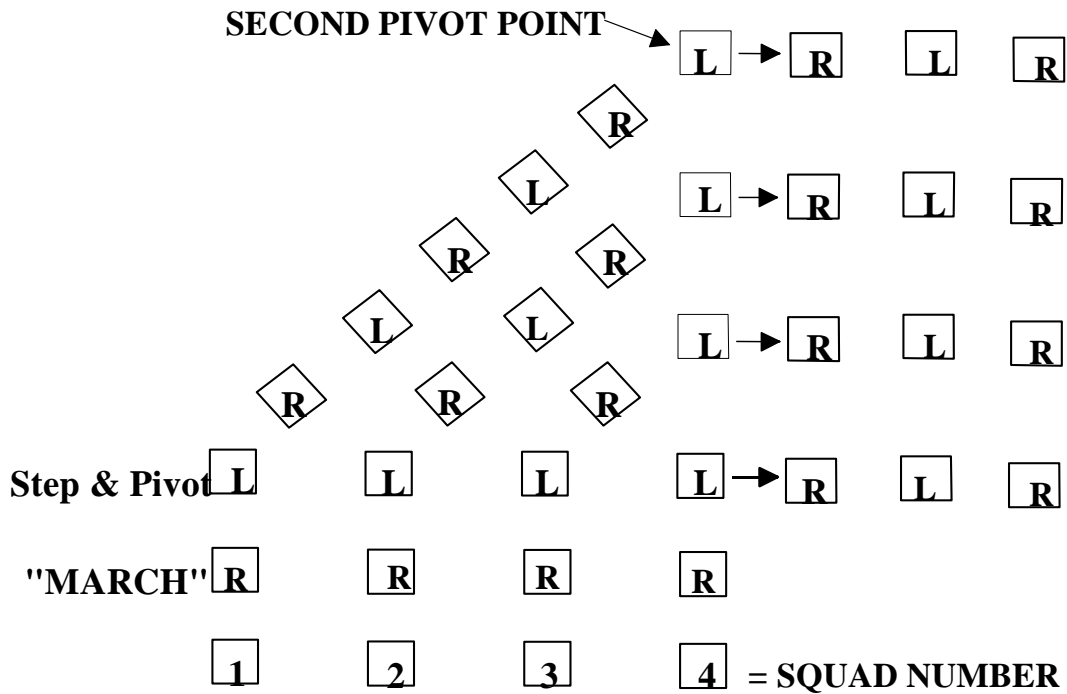

Figure 9-5.--Executing Column Right (Left).

9022. TO MARCH TO THE FLANK

1. The purpose of this movement is to march the platoon to the right or left flank for a short distance. It may be executed from any formation that is marching at quick time or double time cadence. The command is **"By the Right (Left) Flank, MARCH."** The command of execution is given as the foot in the direction of the turn strikes the deck.

2. To execute a right flank when marching at quick time, the command is **"By the Right Flank, MARCH."** On the command of execution **"MARCH,"** everyone takes one more 30-inch step to the front with the left foot and then pivots 90 degrees to the right on the ball of the left foot. Stepping out of the pivot with a 30-inch step, the entire platoon marches in line to the right flank. The platoon commander and guide execute the flanking movement with the platoon, but do not change their position within the platoon. (For the one exception to this, see paragraph 10011.) For the platoon to resume marching in the original direction, the command is **"By the Left Flank, MARCH."** To march to the left flank, substitute left for right and right for left in the above sequence. No other command may be given when marching to the flank until the unit has resumed marching to the original front. (See figure 9-6.)

3. When this movement is executed from a column at close interval, squad(s) to the rear of the squad that becomes the leading squad takes up the half step. They resume a full step as soon as a 40-inch distance has opened between squads. After such a movement, the platoon maintains normal interval until close march is commanded.

4. When marching at double time, on the command of execution **"MARCH,"** everyone takes two more 36-inch steps to the front and then two 6-inch vertical steps in place at double time cadence. While stepping in place, everyone turns 90 degrees toward the direction commanded and then steps off with a 36-inch step in the new direction.

5. When the platoon executes flank movements from a column at close interval, squad(s) to the rear of the squad that becomes the leading squad, will take up a half step. They resume a full step as soon as a 40-inch distance has opened between squads. After such a movement, the platoon maintains normal interval until close march is commanded.

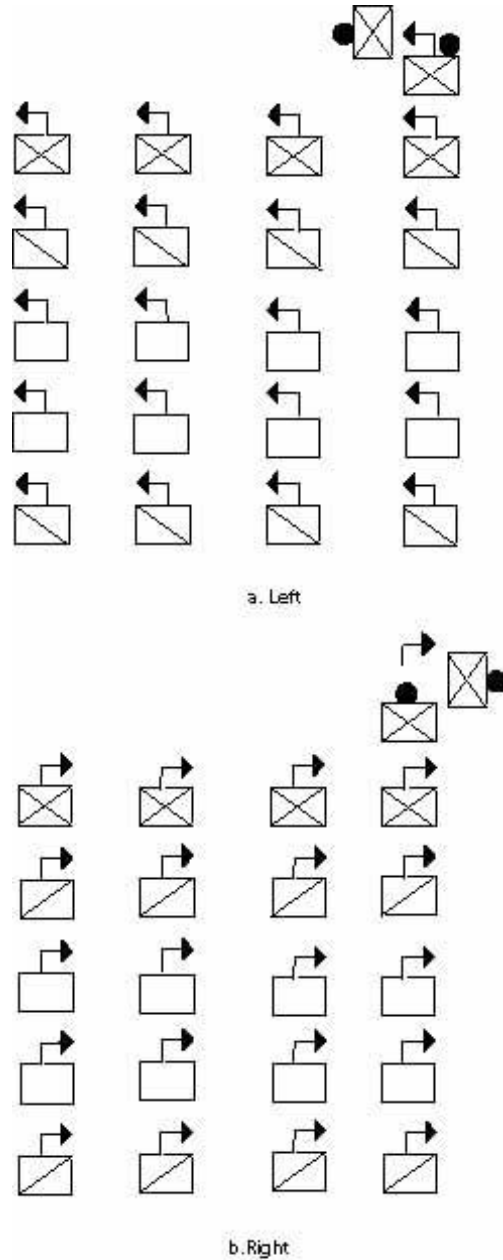

Figure 9-6.--Right (Left) Flank.

9023. TO MARCH IN THE OBLIQUE

1. The purpose of this movement is to shift the line of march to the right or left for a short distance and then resume marching in the original direction. It may be executed from any formation that is marching at quick time cadence. The command is **"Right (Left) Oblique, MARCH."** The word oblique is pronounced to rhyme with strike. The command of execution is given as the foot in the direction of the turn strikes the deck. The command to resume the original direction of march is **"Forward, MARCH."** The command of execution is given as the foot toward the original front strikes the deck.

2. To teach the platoon to march to the oblique, the instructor aligns the unit and has members face half right (left). The instructor then explains that these positions are maintained when marching to the oblique. This is achieved by individuals keeping their shoulders parallel to the persons in front and/or adjacent to them. The individual at the corner of the platoon towards the direction of the oblique is the base of the movement, and must maintain a steady line of march keeping his/her other shoulders blocked perpendicular to the direction of march.

3. To march the platoon in the right oblique, the command is **"Right Oblique, MARCH."** On the command **"MARCH,"** everyone then takes one more 30-inch step to the front with the left foot and pivots 45 degrees to the right on the ball of the left foot. Stepping out of the pivot with a 30-inch step, the entire platoon marches to the right oblique until given another command. (See figure 9-7.) For the platoon to resume marching in the original direction, the command is **"Forward, MARCH,"** in this case the command of execution will be given as the left foot strikes the deck. Everyone then takes one more step in the oblique direction with the right foot; pivots back to the original front and continue to march. To march to the left oblique, substitute left for right and right for left in the above sequence.

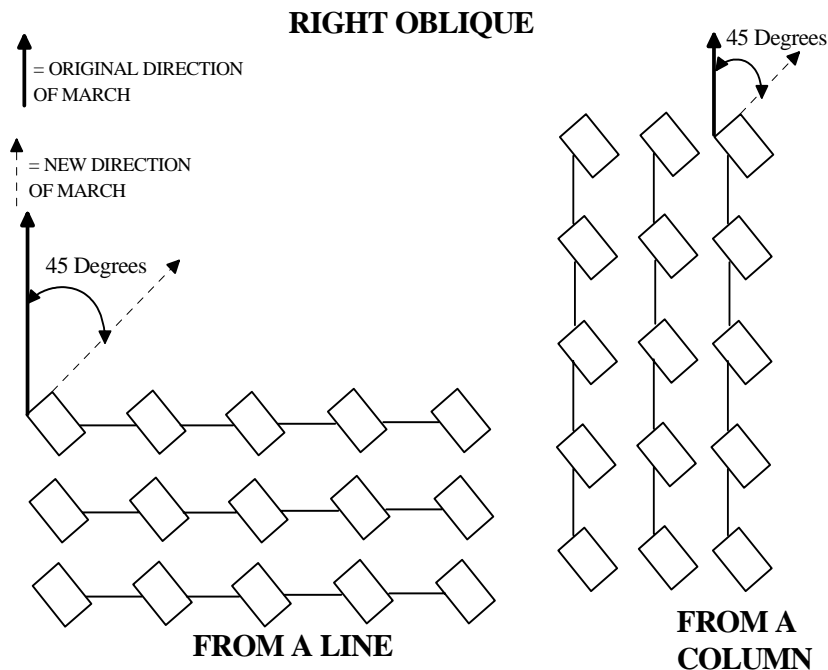

Figure 9-7.--Marching to Right Oblique.

4. To halt the squad facing in the original direction of march the command is **"Platoon, HALT."** The command of execution **"HALT"** is given on the left foot when marching to the right oblique, and on the right foot when marching to the left oblique. At the command **"HALT,"** everyone takes one more step in the oblique direction, pivots to the original front on the toe of the right (left) foot, and places the left (right) foot beside the other at the position of attention.
5. To temporarily halt the squad in the oblique direction, in order to correct errors, the command is **"In Place, HALT."** The command of execution **"HALT"** may be given as either foot strikes the deck. At the command of execution **"HALT,"** the squad halts in two counts as in quick time and remains facing in the oblique direction. The only command that can be given after halting in place is **"Resume, MARCH."** At that command the movement continues marching in the oblique direction.
6. When given half step or mark time while marching in the oblique, the only commands that may be given are, **"Resume, MARCH,"** to continue marching with a 30-inch step in the oblique; or **"In Place, HALT."** to halt in the oblique in order to correct errors.

9024. TO MARCH TO THE REAR

1. The purpose of this movement is to march the platoon to the rear for a short distance. It may be executed when halted or marching forward at quick time or double time. The command is **"To the Rear, MARCH"** it will be given as the right foot strikes the deck.
2. When halted, on the command of execution **"MARCH,"** everyone takes one 15-inch step to the front with the left foot and then pivots 180 degrees toward the right on the balls of both feet. Stepping out of the pivot with a 30-inch step, the entire platoon marches to the rear. For the platoon to resume marching in the original direction, the command **"To the Rear, MARCH"** is given again. No other command may be given when marching to the rear until the unit has resumed marching to the original front.
3. When marching at quick time, on the command of execution **"MARCH,"** everyone takes one more 15-inch step to the front with the left foot and then pivots 180 degrees toward the right on the balls of both feet. Stepping out of the pivot with a 30-inch step, the entire platoon marches to the rear. For the platoon to resume marching in the original direction, the command **"To the Rear, MARCH"** is given again. No other command may be given when marching to the rear until the unit has resumed marching to the original front.
4. When marching at double time, on the command of execution **"MARCH,"** everyone takes two more 36-inch steps to the front and then four 6-inch vertical steps in place at double time cadence. On the first and third steps in place, everyone pivots 180 degrees to the right. After the fourth step in place, and for the fifth step, they step off with a 36-inch step in the new direction. For the platoon to resume marching in the original direction, the command **"To the Rear, MARCH"** is given again. No other command may be given when marching to the rear until the unit has resumed marching to the original front.

9025. TO FORM A COLUMN OF TWOS OR FILES AND REFORM

1. The purpose of these movements is to diminish the front of the platoon in column. They may be executed when the platoon is halted at attention in column of threes or fours, and when at normal or close interval. Squads may be taken from either the right or left side of the platoon. The command to form a column of twos is **"Column of Twos from the Right (Left), MARCH."** The command to form a column of files is **"Column of Files from the Right (Left), MARCH."** When the squad leaders give supplemental commands they turn their head and eyes toward the direction of the movement, give the supplemental command, and turn their head and eyes back to the front. When commanding, **"Squad, HALT,"** the squad leaders turn their head and eyes in the direction of the halted element, regardless of the direction of the movement.

2. When forming a column of files or twos and reforming to threes (fours) it is important to note, in order to keep from inverting the platoon, that:

a. If a column of twos or files were taken FROM the LEFT, then a column of threes (fours) must be formed TO the RIGHT.

b. If a column of twos or files were taken FROM the RIGHT, then a column of threes (fours) must be formed TO the LEFT.

3. When in a Column of Threes, to Form a Column of Twos and Reform

a. On the preparatory command **"Column of Twos from the Right,"** the squad leaders give the following supplementary commands: the two right squad leaders turn their head and eyes to the right give the supplemental command **"Forward,"** the left squad leader turns his/her head and eyes to the left and gives the supplemental command **"Column of Twos to the Left."** The guide remains in position. On the platoon commander's command of execution **"MARCH,"** the two right squads march forward; the left squad forms a column of twos to the left as prescribed in squad drill. (See paragraph 8014.) Then, on commands of its squad leader, the remaining squad executes a column half right and a column half left so as to follow the two leading squads at normal distance in column. (See figure 9-8.)

b. To reform into a column of threes the command is **"Column of Threes to the Left, MARCH."** On the preparatory command, the two lead squad leaders turn their head and eyes to the left and give the supplementary **"STAND FAST."** The remaining squad leader then turns his/her head and eyes to the left and commands **"Column of Files from the Right"** and **"Column Half Left."** On the platoon commander's command of execution **"MARCH,"** the two leading squads stand fast; the rear squad forms single file from the right.

(1) The squad leader steps half left in marching turns his/her head and eyes to the right and quickly commands **"Column Half Right, MARCH,"** and executes the command so as to be marching to the left of and parallel to, the lead squads. He/she would continue to march forward until nearing the lead squad leaders, at which time the squad leader turns his/her head and eyes to the right and gives the command **"Squad, HALT."** The squad is halted so that it is aligned with, and the proper interval from, the two lead squads. (See figure 9-8.)

(2) The remaining members of the squad step off by twos (two and three; four and five; six and seven; etc.) in the left oblique. The even numbered members of the squad take one step in the left oblique and pivot back to the original direction of march, following the squad leader. The odd numbered members of the

squad take three steps in the left oblique and pivot back to the original direction of march, following the squad leader. The steps in the oblique may be adjusted so as to obtain proper interval from the two lead squads.

c. To form a column of twos from the left and reform to a column of threes to the right, use the same procedure as described in paragraph 9025.3b above substituting left for right and right for left. On the platoon commander's preparatory command of **"Column of Twos from the Left,"** the guide changes position to be in front of the second squad leader. When reforming to threes, after all squads have halted, the guide moves back in front of the third squad leader.

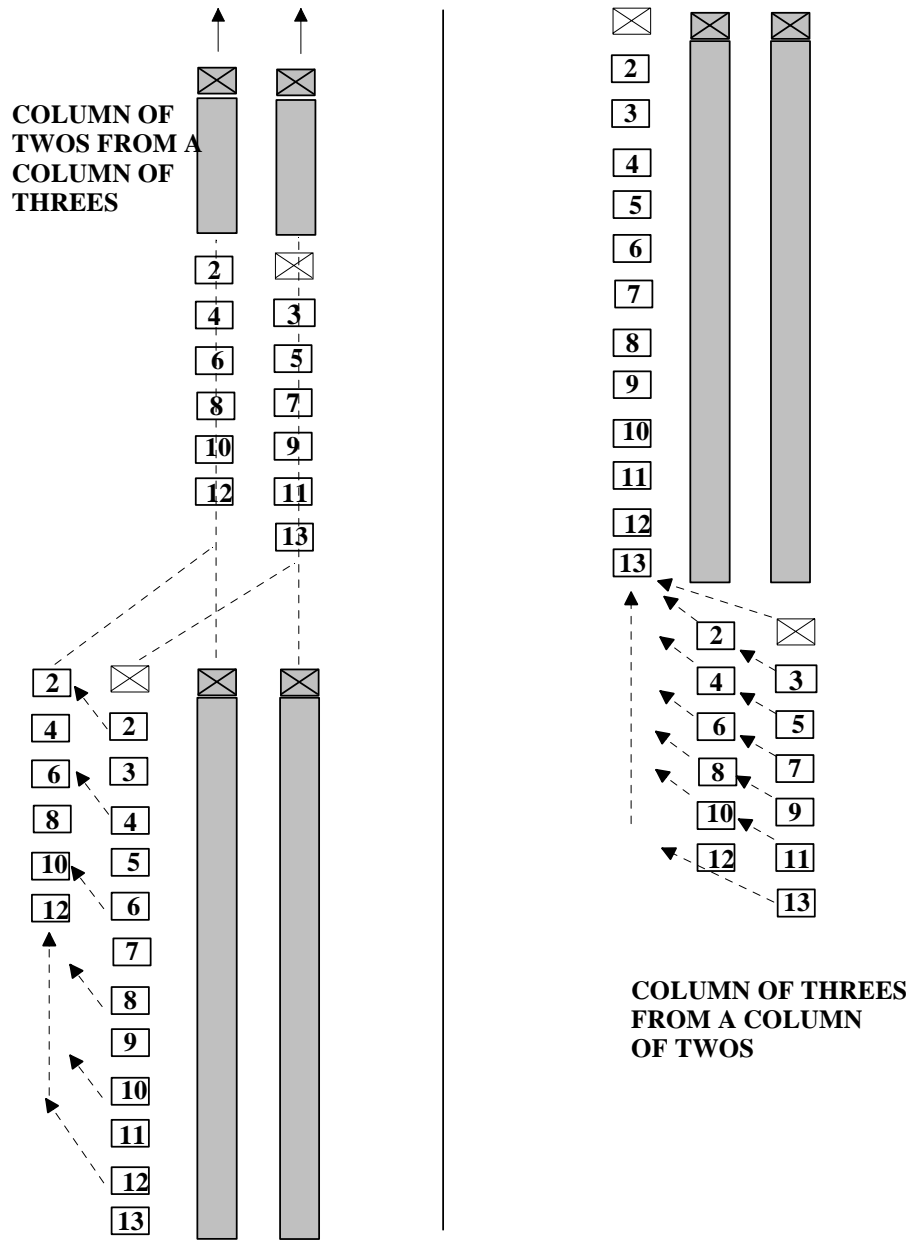

Figure 9-8.--Column of Twos from Column of Threes and Reform.

4. When in a Column of Fours, to Form a Column of Twos and Reform

a. To form a column of twos from a column of fours the command is **"Column of Twos from the Right, MARCH."** On the preparatory command **"Column of Twos from the Right,"** the squad leaders give the following supplementary commands: the two right squad leaders simultaneously turn their head and eyes to the right and give the supplemental command **"Forward."** Then the two left squad leader simultaneously turn their head and eyes to the right and give the supplemental command **"STAND FAST."** The guide remains in position. On the platoon commander's command of execution **"MARCH,"** the two right squads march forward; the two left squads stand fast. When the two left squad leaders are about to be passed by the end of the two right squads they simultaneously turn their head and eyes to the right and command **"Column Half Right, MARCH."** They then step half right in marching, and in unison, command **"Column Half Left, MARCH"** so to follow the two leading squads at the proper distance. (See figure 9-9.)

b. To reform from a column of twos to a column of fours the command is **"Column of Fours to the Left, MARCH."** On the preparatory command **"Column of Fours to the Left,"** the squad leaders give the following supplementary commands: the two lead squad leaders simultaneously turn their head and eyes to the left and command **"STAND FAST;"** the two rear squad leaders then simultaneously turn their head and eyes to the left and command **"Column Half Left."** On the command of execution **"MARCH:"**

(1) The two lead squads stand fast.

(2) The two rear squads execute a column half left from the halt. The two squad leaders then simultaneously turns their head and eyes to the right and command **"Column Half Right, MARCH"** so to be marching to the left of and parallel to the lead squads. They would continue to march forward until nearing the lead squad leaders, at which time the squad leader simultaneously turn their head and eyes to the right and give the command **"Squad, HALT."** The squads are halted so that it is aligned with, and the proper interval from the two lead squads.

c. To form a column of twos from the left and reform to a column of fours to the right, use the same procedure as described in paragraph 9025.4b above substituting left for right and right for left. On the platoon commander's preparatory command of **"Column of Twos from the Left,"** the guide changes position to be in front of the second squad leader. When reforming to fours, after all squads have halted, the guide moves back in front of the fourth squad leader.

5. When in a Column of Threes, to Form a Column of Files and Reform

a. On the preparatory command **"Column of Files From the Right,"** squad leaders turn their head and eyes to the right and give the following supplementary commands. The third squad leader commands **"Forward."** The remaining squad leaders command **"STAND FAST."** The guide remains in position. On the platoon commander's command of execution **"MARCH,"** the third squad marches forward; the remaining squads stand fast, then as the fourth to the last member of the squad to the right is about to pass their position the squad leader. (See figure 9-10.)

(1) The second squad leader turns his/her head and eyes to the right and commands **"Column Half Right, Column Half Left, MARCH."** The squad leader on his/her own command of execution **"MARCH,"** steps in the right oblique then pivots back to the left, so as to march at normal distance in single file behind the leading squad. The remaining squad members march forward and execute the pivots on the same point as established by the squad leader.

(2) The first squad leader turns his/her head and eyes to the right and commands **"Column Half Right, MARCH"** and **"Column Half Left, MARCH,"** so as to march at normal distance in single file behind the leading squad.

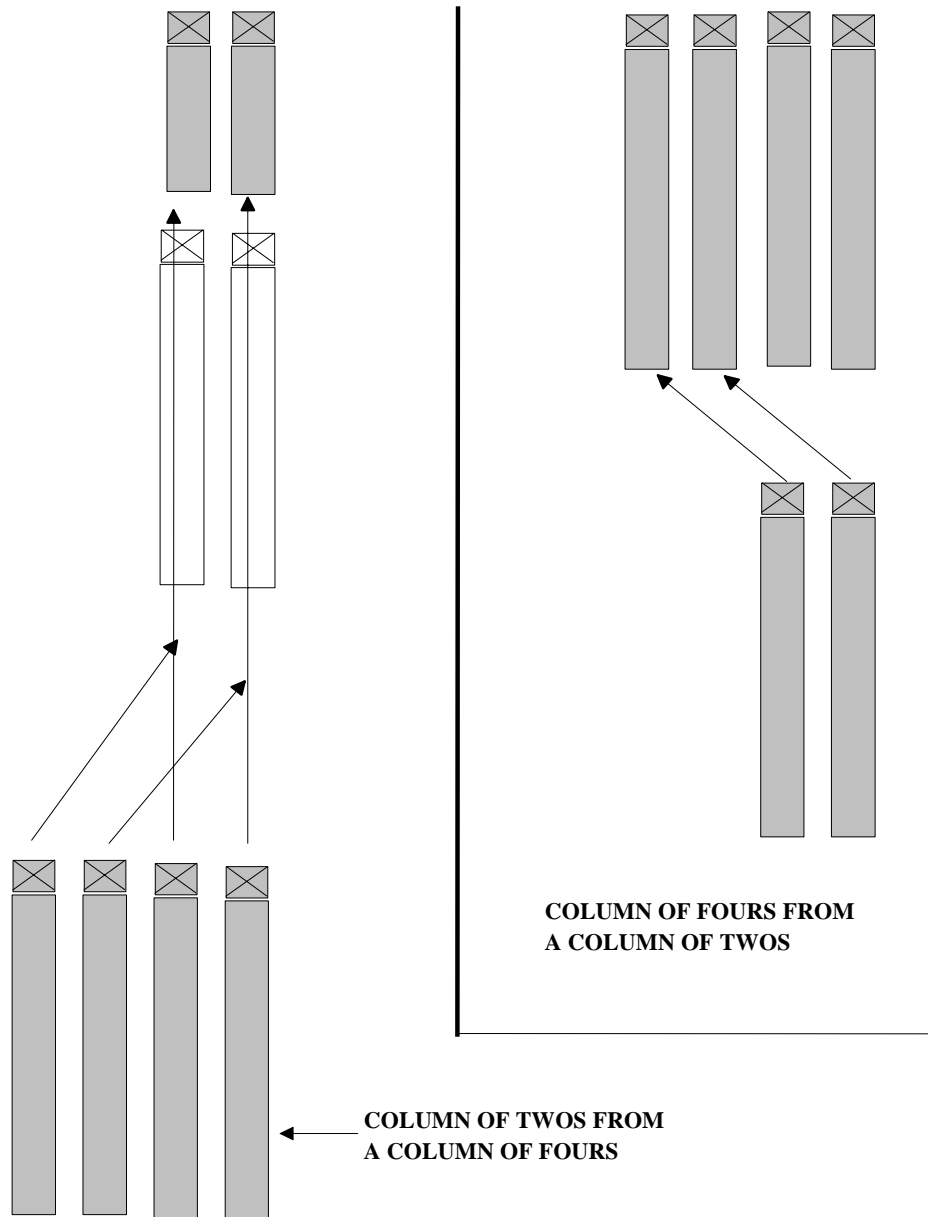

Figure 9-9.--Column of Twos from Column of Fours and Reform.

b. To reform into a column of threes, the command is **"Column of Threes to the Left, MARCH."** On the preparatory command, squad leaders, in sequence, give the following supplementary commands: the third squad leader turns his/her head and eyes to the left and commands **"STAND FAST;"** the second squad leader turns his/her head and eyes to the left and commands **"Column Half Left, Column Half Right;"** and the first squad leader turns his/her head and eyes to the left and commands **"Forward."** On the platoon commander's command of execution **"MARCH:"**

(1) The leading squad stands fast.

(2) The second squad leader takes one step in the left oblique then pivots back to the right, so as to be marching to the left of and parallel to the lead squad. The remaining squad members march forward and execute the pivots on the same point as established by the squad leader. The squad leader would continue to march forward until nearing the lead squad leader, at which time he/she turns his/her head and eyes to the right and gives the command **"Squad, HALT."** The squad is halted so that it is aligned with, and the proper interval from the two lead squads.

(3) The first squad marches forward until approaching the end of the lead squad. The squad leader then turns his/her head and eyes to the left and commands, **"Column Half Left, MARCH."** The squad leader then turns his/her head and eyes to the right and commands **"Column Half Right, MARCH"** in order to place his/her squad to the left of and at proper interval from the second squad. The squad would continue to march forward until nearing the second squad leaders, at which time the squad leader turns his head/her and eyes to the right and gives the command **"Squad, HALT."** The squad is halted so that it is aligned with, and the proper interval from the two lead squads.

c. To form a column of files from the left and reform to a column of threes to the right, use the same procedure as described in paragraphs 9025.5b(2) and (3) above substituting left for right and right for left. On the platoon commander's preparatory command of **"Column of Files from the Left,"** the guide changes position to be in front of the first squad leader. When reforming to threes, after all squads have halted, the guide moves back in front of the third squad leader.

6. Forming a column of files and reforming when in a column of fours is executed in a similar manner as when in a column of threes.

7. When marching in column of twos, the platoon commander is ahead of the left file and the guide is in front of the right file. When marching in single file, the guide leads the platoon, the platoon commander marches abreast of and to the left of the guide. If executing the movements for practice or instructional purposes the platoon commander would position himself/herself where he/she could best supervise the platoon.

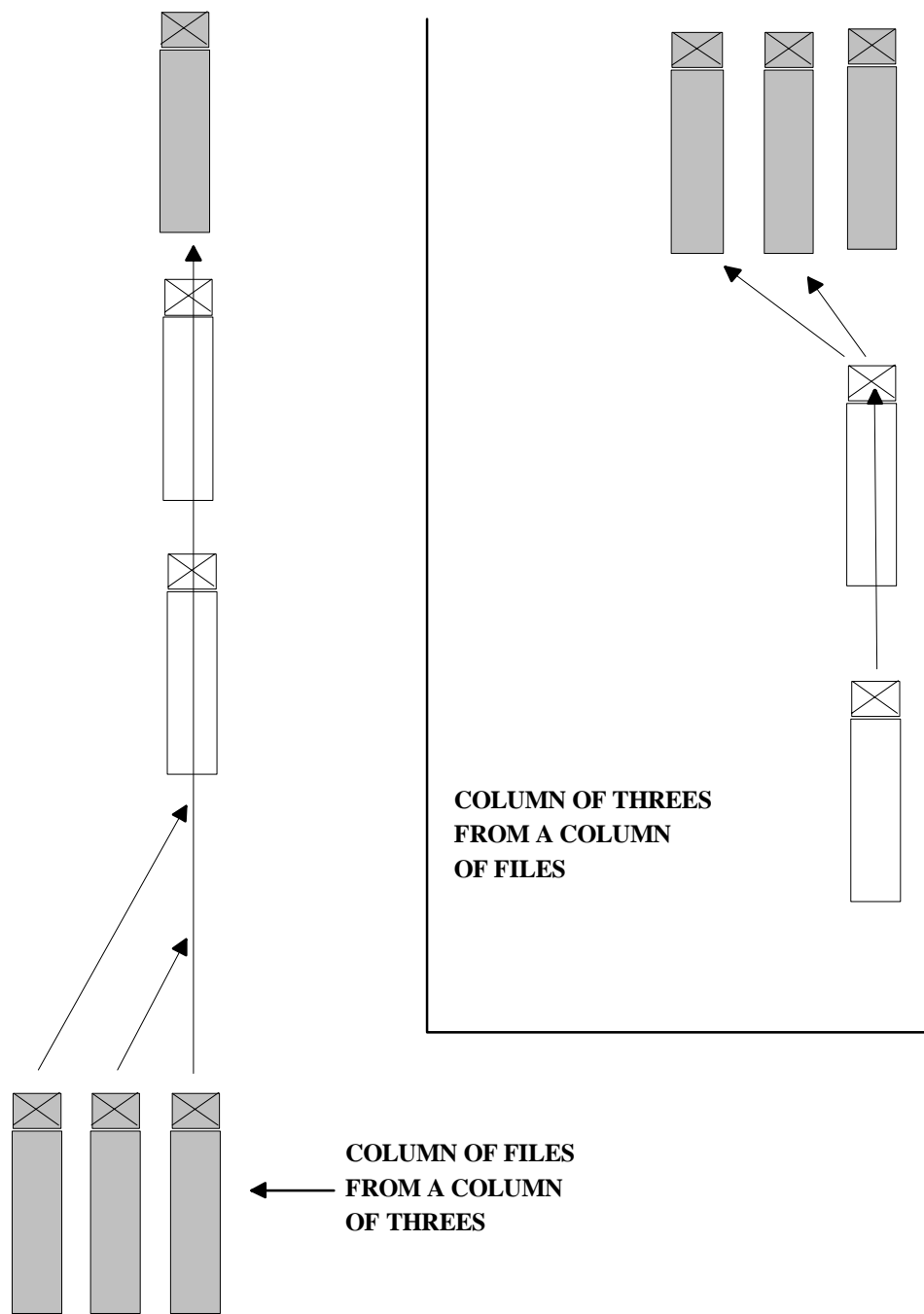

Figure 9-10.--Column of Files from Column of Threes and Reform.

MARINE CORPS DRILL AND CEREMONIES MANUAL

PART I: DRILL

CHAPTER 10

COMPANY DRILL

	<u>PARAGRAPH</u>	<u>PAGE</u>
GENERAL	10000	10-3
RULES FOR COMPANY DRILL	10001	10-4
TO FORM THE COMPANY	10002	10-5
TO DISMISS THE COMPANY	10003	10-7
BEING IN LINE, TO FORM COLUMN AND REFORM INTO LINE	10004	10-8
TO ALIGN THE COMPANY	10005	10-9
BEING IN COLUMN, TO CHANGE DIRECTION	10006	10-10
BEING IN COLUMN, TO FORM MASS FORMATION	10007	10-10
BEING IN COLUMN, TO FORM EXTENDED MASS FORMATION	10008	10-12
BEING IN MASS OR EXTENDED MASS FORMATION, TO CHANGE DIRECTION	10009	10-13
BEING IN MASS OR EXTENDED MASS FORMATION, TO FORM COLUMN	10010	10-13
BEING IN COLUMN, TO FORM COLUMN OF PLATOONS IN LINE	10011	10-14
BEING IN COLUMN OF PLATOONS IN LINE, TO FORM COLUMN	10012	10-15
BEING IN COLUMN, TO FORM COLUMN OF TWOS OR FILES AND REFORM	10013	10-16
COMPANY AWARDS FORMATIONS	10014	10-17

FIGURE

10-1 COMPANY IN LINE FORMATION	10-7
10-2 COMPANY IN COLUMN FORMATION	10-8
10-3 COMPANY MASS FORMATION	10-11
10-4 COMPANY IN EXTENDED MASS FORMATION	10-13
10-5 COLUMN OF PLATOONS IN LINE FORMATION	10-15
10-6 PLACING OF AWARD RECIPIENTS FOR THE CEREMONY	10-17
10-7 MOVEMENTS OF THE AWARD RECIPIENTS	10-19

MARINE CORPS DRILL AND CEREMONIES MANUAL

PART I: DRILL

CHAPTER 10

COMPANY DRILL

10000. GENERAL

1. A company consists of a company headquarters and two or more platoons.
2. For close order drill and ceremonies, company headquarters personnel may be attached to platoons without interfering with the permanent squad organization. For marches, members of the company headquarters command group are formed as directed by the company commander or higher authority.
3. Formations used by the company are line, column (of threes, etc.), mass, extended mass, and column of platoons in line. In all these formations, the platoons that comprise the company will either be in line (each squad forming one rank) or in column (each squad forming one file). The company may also form column of twos or files in a manner similar to that prescribed for a platoon, in which case the platoons are arranged as in column, except that each platoon is in column of twos or files. Formations of the company for drills and ceremonies, to include posts of officers and key noncommissioned officers, are shown in figures 10-1 through 10-5.
 - a. When the company commander is absent, the senior officer present with the company takes post and drills the company as prescribed for the company commander. In the absence of the first sergeant, the senior noncommissioned officer (normally the gunnery sergeant) takes post and performs the duties of first sergeant.
 - b. When officers are not present, after the company is formed, the first sergeant, or in his/her absence, the next senior staff noncommissioned or noncommissioned officer takes post and drills the company as prescribed for the company commander, and platoon sergeants take post and perform the duties of platoon commanders. This also applies when, for any reason, the company commander directs the first sergeant (or senior staff noncommissioned or noncommissioned officer) to take charge of the company for purposes other than dismissing the company. When this occurs, the officers retire and the first sergeant and platoon sergeants march by the most direct route to take post as the company commander and platoon commanders, respectively.
 - c. For drill and ceremonies, the following minimum key billets within the company must be filled by applying the above rules: company commander, guidon bearer, and first sergeant in the company headquarters; and a platoon commander, platoon sergeant, and guide for each platoon, plus one squad leader per squad within each platoon. (NOTE: When officers are not present and the first sergeant and platoon sergeants are acting as company commander and platoon commanders respectively, other noncommissioned officers need not be detailed to also act as first sergeant and/or platoon sergeants.)
 - d. For drill and ceremonies, the company guidon is carried by the guidon bearer. In all formations, the guidon bearer is 1 pace to the rear and 1 pace to the left of the company commander or first sergeant, as appropriate. For marches in the field, the guidon is kept with company headquarters baggage unless otherwise directed. If carried on marches in the field, the guidon bearer takes post as described above for drill and ceremonies.

4. During company physical training and conditioning marches when the company is in column, the first sergeant will move from his/her normal position at the rear of the column and assume a position to the left of the company commander. If the guidon is also present it will be carried on the march or run to the rear of the company commander and first sergeant.

10001. RULES FOR COMPANY DRILL

1. The platoon, rather than the company, is the basic drill unit. Only such formations are prescribed for the company as are necessary for marches, drills, and ceremonies.

→ 2. In company drill, if all Marines in the unit are to execute the same movement simultaneously, platoon commanders will repeat preparatory commands of the company commander except:

a. When commands such as "**FALL OUT**" are given, which combine the preparatory command and command of execution.

b. When the preparatory command of the company commander is "**Company,**" the platoon commanders give the preparatory command "**Platoon.**"

c. When in mass formation, platoon commanders repeat preparatory commands only when the order will require independent movement by a platoon.

d. When the platoons of the company are to execute a movement in successive order, such as a column movement, the platoon commander of the first platoon to execute the movement repeats the company commander's preparatory command, and those of following platoons give an appropriate caution such as "**Continue to March.**" Platoon commanders of following platoons repeat the company commander's preparatory command and command of execution at the proper time to cause their platoons to execute the movement on the same ground as the first platoon.

e. When participating in parades and ceremonies when commands by the adjutant, commander of troops, or company commander can be clearly heard, supplemental commands need not be given.

3. Platoon commanders turn their head and eyes when giving supplemental commands using the following rules.

a. When executing halted movements, such as the manual of arms, the platoon commander turns his/her head and eyes to the right.

b. For movements that involve marching, (e.g., forming from column into mass, mass into column or column movements) the platoon commander turns his/her head and eyes to the direction of the movement to give supplemental command.

c. When bringing the platoon on line with a halted element the platoon commander turns his/her head and eyes towards the halted element to give the command of mark time or halt.

4. When commands involve movements of the company in which one platoon stands fast or continues the march, while one or more of the others do not, its commander commands "**STAND FAST**" or "**Continue to March,**" as the case may be.

Enclosure (1)

5. The company marches, executes change of direction, closes and extends intervals between squads in column, opens and closes ranks, and stacks and takes arms as in platoon drill.
6. The company executes marching in line only for minor changes in position.
7. Unless otherwise specified for the company to be at close interval, all changes in formation must be executed with files and ranks formed at normal interval and distance.

10002. TO FORM THE COMPANY

1. At the command "**FALL IN,**" the company forms in line formation at normal interval and distance. If it is desired to form the company at close interval between files, the command "**At Close Interval, FALL IN**" is given. In this case, the platoons form in line, but files within each platoon are at close interval (4 inches). The company forms at close interval only for roll calls or when space is limited. The company may be formed by its staff noncommissioned or noncommissioned officers under charge of the first sergeant, or by its officers under command of the company commander, as described below.

2. Forming the Company by Noncommissioned Officers

a. The first sergeant takes post 9 paces in front of the point where the center of the company is to be, faces that point, draws sword if so armed, and commands "**FALL IN**" ("**At Close Interval, FALL IN**"). At this command, the guidon bearer takes post facing the front 1 pace to the front and 1 pace to the right of the first sergeant (the first sergeant facing the company), and the company forms in line with platoons in line at normal (close) interval and 4 paces between platoons. Each platoon sergeant takes post 3 paces in front of and facing the point where the center of the platoon is to be, faces that point, and draws sword if so armed. Each platoon then forms (as prescribed in paragraph 9004), under the supervision of the platoon sergeant.

b. Platoon sergeants then command "**REPORT.**" Remaining in position (at order arms if armed with the rifle), the squad leaders, in succession from front to rear in each platoon, salute and report, "All present," or "Private _____ absent." Platoon sergeants then command "**Inspection, ARMS;**" "**Port, ARMS;**" and "**Order, ARMS**" if troops are armed with rifles, then face about to the front. If troops are not armed with rifles, the platoon sergeant immediately faces the front after receiving the reports of the squad leaders. (NOTE: If platoons cannot be formed in regularly organized squads prior to forming the company, the platoon sergeants command "**Inspection, ARMS;**" "**Port, ARMS;**" "**Right Shoulder, ARMS;**" and call the roll. Each Marine answers "here," and goes to order arms as their name is called. The platoon sergeant then organizes the platoon into squads and faces the front. The manual of arms is omitted for personnel not armed with rifles.)

c. After all platoon sergeants have completed receiving the reports of their squad leaders and are facing the front, the first sergeant commands "**REPORT,**" at which time the platoon sergeants, beginning with the right platoon, successively salute and report, "All present or accounted for" or "_____ men absent." The first sergeant returns each salute individually. What occurs next depends upon whether the company commander and platoon commanders receive the company or not.

(1) If company officers do not receive the formation, after receiving the reports of all the platoon sergeants, the first sergeant commands, "**POST.**" On this command, the platoon sergeants and guidon bearer step forward three steps; simultaneously, the first sergeant faces about and steps forward three steps. The company is now formed with the first sergeant and platoon sergeants occupying the posts prescribed for the company commander and platoon commanders.

(2) If company officers receive the formation, the company commander and platoon commanders normally observe the initial procedures from a location to the rear of where the company is forming (officers remain with swords in their scabbards, if so armed). In this case, after receiving the reports of the platoon sergeants, the first sergeant faces the front and awaits the arrival of the company commander. When the company commander has taken post 12 paces front and center of the company, the first sergeant salutes and reports "Sir/Ma'am, all present or accounted for." or "Sir/Ma'am, _____ Marines absent." The company commander returns the salute, and may discuss absentees and issue necessary instructions to the first sergeant. Next, the company commander directs the first sergeant to "**TAKE YOUR POST,**" at which the guidon bearer marches forward 3 paces, and the first sergeant and platoon sergeants march by the most direct routes to their posts, the former in rear of the company, the latter on the left of the rear rank of their platoons; simultaneously, the company executive officer takes post to the rear of the company and the platoon commanders move around the right front of their platoons and take their posts 6 paces front and center of their platoons. After all officers are in position, if armed with the sword, the company commander draws sword; the company executive officer and platoon commanders draw sword with the company commander.

3. Forming the Company by Officers

a. Normally, the company is initially formed by the staff noncommissioned or noncommissioned officers, then received by the officers as described in paragraph 10002 above. This permits detailed musters to be taken by the staff noncommissioned or noncommissioned officers. During the course of training, if the company has been dismissed for a short period of time, it may be initially reformed by the company commander to save time.

b. When the company is initially formed by the company commander, the procedures are the same as forming with the staff noncommissioned or noncommissioned officers, except that the company commander takes post 12 paces front and center and facing the point where the center of the company is to be, draws sword if so armed, and commands "**FALL IN.**" Platoon commanders then take posts 6 paces front and center and facing the point where the center of their platoons will be, draw sword if so armed, form their platoons and receive the reports of their squad leaders, then face the front. After all platoon commanders have formed their platoons and are facing the front, the company commander commands "**REPORT,**" at which time each platoon commander, in succession from right to left, salutes and reports, "Sir/Ma'am, all present or accounted for," or "Sir/Ma'am, Marines absent."

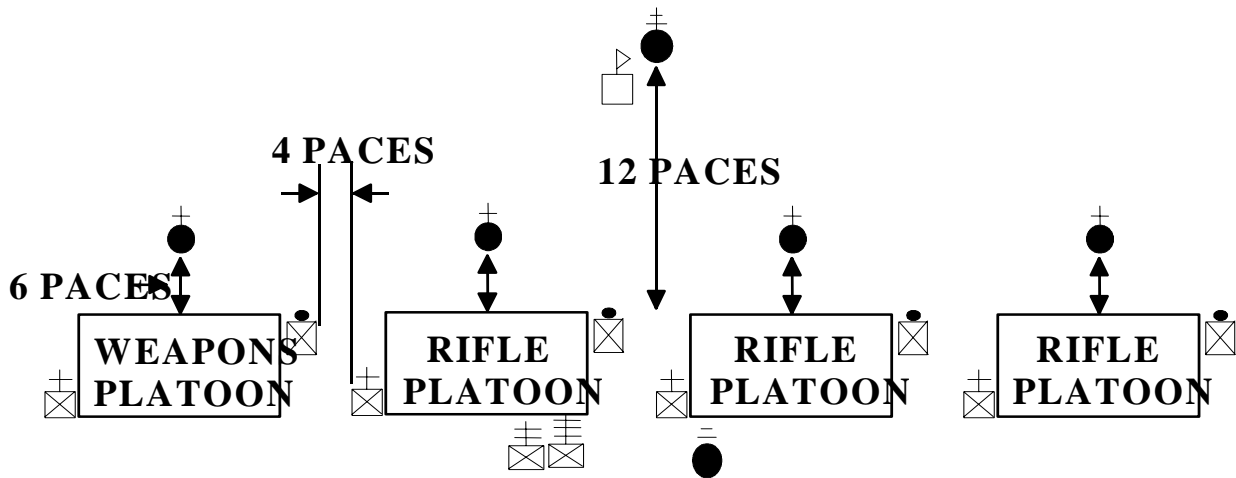

Figure 10-1.--Company in Line Formation.

10003. TO DISMISS THE COMPANY

1. The commands are **"FIRST SERGEANT"** and **"DISMISS THE COMPANY."** The company being in line at a halt, at the command **"FIRST SERGEANT,"** the first sergeant moves by the most direct route to a point 3 paces from the company commander (9 paces in front of the center of the company), halts, and salutes the company commander returns the salute and passes any directions or information necessary to the first sergeant. The company commander directs the first sergeant to **"DISMISS THE COMPANY."** The first sergeant and company commander exchange salutes. After returning the first sergeant's salute the company commander, returns sword, if so armed, and falls out. Other officers of the company return sword, if so armed, and fall out at the same time and in the same manner as described in paragraph 10002.2c(2). The platoon sergeants take their posts 3 paces in front of the centers of their platoons. The first sergeant, when the company commander returns his/her salute, executes an about face. When the platoon sergeants have taken their positions, the first sergeant commands **"Inspection, ARMS;" "Port, ARMS;"** and **"DISMISSED."**

2. The company being in line at a halt, dismissal may also be ordered by the command **"DISMISS YOUR PLATOONS."** The platoon commanders salute; the company commander returns their salute, returns sword, if so armed, and falls out. The platoon commanders execute about face and command **"PLATOON SERGEANT."** The platoon sergeant takes his/her post 3 paces in front of the center of the platoon halts, facing the platoon commander and salutes. The platoon commander returns the salute and passes any directions or information necessary to the platoon sergeant. The platoon commander then directs the platoon sergeant to **"DISMISS THE PLATOON,"** the platoon sergeant and platoon commander exchange salutes. After the platoon commander has returned the platoon sergeant's salute, he/she returns sword if so armed, and falls out. The platoon sergeant then faces the platoon and commands **"Inspection, ARMS;" "Port, ARMS;"** and **"DISMISSED."**

3. The first sergeant may cause platoons to be dismissed by the platoon sergeants by commanding **"DISMISS YOUR PLATOONS."** The platoon sergeants salute; the first sergeant returns the salute, returns sword if so armed, and falls out. The platoon sergeants then execute about face and command **"Inspection, ARMS;" "Port, ARMS;"** and **"DISMISSED."**

10004. BEING IN LINE, TO FORM COLUMN AND REFORM INTO LINE

1. Being at a halt and at the order in line, to form column, the company commander orders **"Right, FACE."** After facing to the right, all officers, key staff noncommissioned or noncommissioned officers, and the guidon bearer march by the most direct routes to their posts in column. The company commander may then cause the column to march (NOTE: As platoons and squads become inverted if the company is faced to the left, this should be done only for short movements.).

2. Being at a halt and at the order in column, to form line, the company commander commands **"Left, FACE."** (NOTE: If the company is at close interval they must be extended to normal interval, paragraph 9015, prior to executing left face. Otherwise there will not be 40 inches of distance between ranks.) After facing to the left, all officers, key noncommissioned officers, and the guidon bearer march by the most direct routes to their posts in line. (NOTE: When in column, if the company is faced to the right, platoons and squads become inverted. Therefore, to form line facing the right flank of a column, the company should first be marched by executing necessary changes in direction, so that after halting and facing to the left, line will be formed facing the desired direction.)

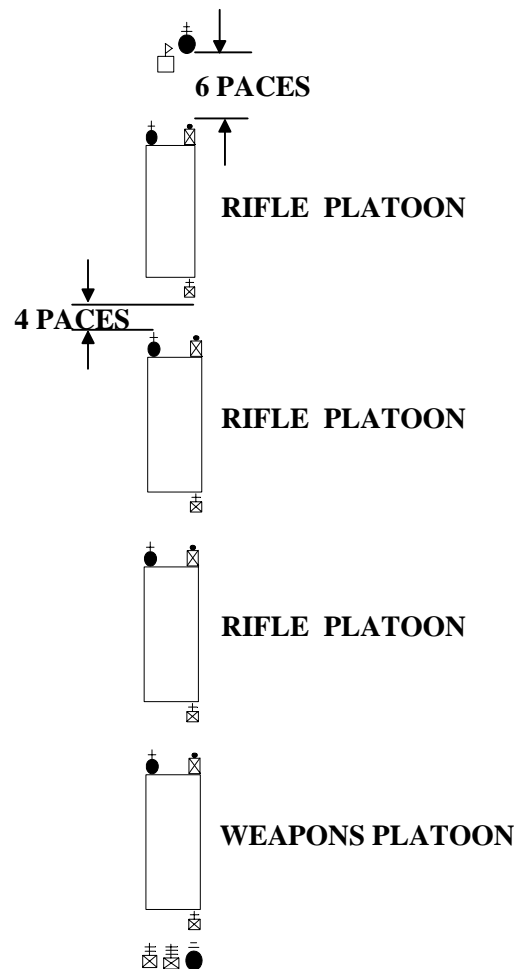

Figure 10-2.--Company in Column Formation.

10005. TO ALIGN THE COMPANY

1. To align the company when in line at a halt, the company commander commands, **"DRESS RIGHT (CENTER, LEFT)."** At the command **"DRESS RIGHT,"** the platoon commander of the base platoon aligns his/her platoon immediately by the commands **"Dress Right, DRESS;" "Ready, FRONT;"** and **"COVER."** After the platoon commander of the base platoon gives the command to dress right, the remaining platoon commanders will align their platoons in successive order. When **"DRESS CENTER"** is given, the commander of the center platoon, which is the base platoon for this movement, aligns the platoon to the center of the company. The base platoon for this movement is the second platoon in both three and four platoon companies. After the base platoon commander has aligned the platoon, the remaining platoon commanders will align their respective platoons on the base platoon by executing **"Dress Right (Left), DRESS;" "Ready, FRONT;"** and **"COVER,"** as explained in paragraph 9009.

2. To align the company when in mass formation at a halt, the company commander commands **"Dress Right (Left), DRESS"** or **"At Close Interval, Dress Right (Left), DRESS;" "Ready, FRONT;"** and **"COVER."**

a. At the command **"Dress Right (Left),"** the platoon commander of the base platoon goes to carry sword if so armed.

b. On the command of execution **"DRESS,"** the platoon commander of the base platoon takes one step forward, executes a right flank, moves to a position 1 pace to the right of the right squad leader, executes another right flank and halts 1 pace to the right of the rank of squad leaders. He/she then executes a right face and verifies the alignment of the squad leaders in the same manner as alignment is verified in paragraph 9009. He/she then verifies the alignment of the rest of the company as described in paragraph 9009. (Note: During parades and ceremonies the platoon commander of the base platoon would normally only check the alignment of the 1st, 5th, 9th and 13th (last) rank.) After verifying the alignment of the last rank the platoon commander marches back to the front of the formation 1 pace past the guide. He/she then executes a left flank and moves, by the most direct route, back to his/her position at the head of his/her platoon. The platoon commander then halts, from the oblique, faces right and goes to order sword. When the platoon commander resumes his/her post, the company commander commands **"Ready, FRONT"** and **"COVER."**

3. To align the company when in extended mass formation at a halt, the company commander commands **"Dress Right (Left), DRESS"** or **"At Close Interval, Dress Right (Left), DRESS;" "Ready, FRONT;"** and **"COVER."** Alignment is verified as described in paragraph 10005.2b, above. Except that all platoon commanders move to verify the alignment of their platoons.

4. To align the company when in column, platoons in column, the command is **"COVER."** At that command, the second and following platoons obtain the proper 4-pace distances between platoons and cover on the files of the leading platoon. Each platoon aligns internally as prescribed in paragraph 9009.

5. To align the company when in column of platoons in line at halt, the company commander commands, **"DRESS RIGHT (LEFT)."** At this command, the leading platoon (which is the base platoon) is immediately aligned by its commander who commands, **"Dress Right (Left), DRESS;" "Ready, FRONT;"** and **"COVER."** After the platoon commander of the base platoon has given the command to align the platoon, the remaining platoon commanders in succession from front to rear give the command to align their platoons. Platoon commanders follow the procedures prescribed in paragraph 9009, and ensure that the guides are covered on the guide of the leading platoon.

10006. BEING IN COLUMN, TO CHANGE DIRECTION

1. Being at a halt or in march while in column, to change direction 90 degrees to the right (left), the company commander orders "**Column Right (Left), MARCH.**" On the preparatory command, platoon commanders give the following supplementary commands: leading platoon commander, "**Column Right (Left);**" and remaining platoon commanders, "**Forward,**" if initiated from a halt ("**Continue to March,**" if initiated while marching). On the company commander's command of execution "**MARCH,**" the leading platoon executes a column right (left). Succeeding platoons march forward, and on the commands of their platoon commanders, execute a column right (left) on the same ground as the leading platoon.
2. To execute a 45-degree change in direction, the execution is the same as above, except the command "**Column Half Right (Left), MARCH**" is used. Platoon commanders give appropriate supplementary commands.
3. For slight changes in direction, on the command of the company commander to "**INCLINE TO THE RIGHT (LEFT),**" the guide of the leading platoon changes direction as commanded. Succeeding platoons march forward and change direction on the same ground as the leading platoon. No supplementary commands are given by the platoon commanders.

10007. BEING IN COLUMN, TO FORM MASS FORMATION

1. Being at a halt in column at close or normal interval, the company commander orders "**Company, Mass Left, MARCH.**" On the preparatory command, platoon commanders give the following supplementary commands: leading platoon commander turns his/her head and eyes to the left and commands "**STAND FAST;**" remaining platoon commanders turn their head and eyes to the left and command "**Column Half Left.**" On the company commander's command of execution "**MARCH,**" the leading platoon stands fast, and the remaining platoons simultaneously execute a column half left. On commands of their platoon commanders, the remaining platoons then execute a column half right so as to move into positions alongside the leading platoon at the appropriate interval. As each platoon commander is about to come on line with the leading rank of the halted element, they turn their head and eyes to the right and command "**Mark Time, MARCH.**" The platoon marks time 4-8 counts to gain cover and alignment and is halted by the platoon commander. This forms the company in mass at the appropriate intervals between all adjacent platoons and files.
2. The company on the march in column at close or normal interval is given the same commands at the halt, except that on the preparatory command the leading platoon commander commands "**Mark Time.**" On the company commander's command of execution "**MARCH,**" the leading platoon marks time 4-8 counts then halts on command of its platoon commander. The commands and movements for the remaining platoons are the same as for executing the movement from a halt.
3. If the company was in column at normal interval, then the company mass is at normal interval (e.g., normal interval between files in the platoons and normal interval between platoons in the company). If the company was in column at close interval, then the company mass is at close interval (e.g., close interval between files in the platoons and close interval between platoons in the company).

4. To form a company mass right use the same commands as in paragraph 10007 substituting left for right and right for left. However, forming a company into a mass right results in the platoons being inverted and should only be done under unusual circumstances.

5. There will be occasions when enlisted personnel form the company in mass as part of a larger formation. When the company officers receive the company the same procedures as in paragraph 10002.2c(2) will be used except, that all key personnel on the command **"TAKE YOUR POST"** will execute the following.

a. The platoon commanders will be at the rear of the formation in reverse order.

b. On the command **"TAKE YOUR POST"** the first sergeant will move by the most direct route around the left of the formation and assume his/her normal positions in the rear of the formation.

c. The guidon will move 3 paces forward to his/her position 1 pace to the left and behind the company commander.

d. The platoon commanders will move to their position in front of their respective first squad leaders by the most direct route. This is done by marching in column around the right of the formation until they are 1 pace from their first squad leader and then take one step in the left oblique, halt in front of the squad leader and on line with the guides and execute a right face.

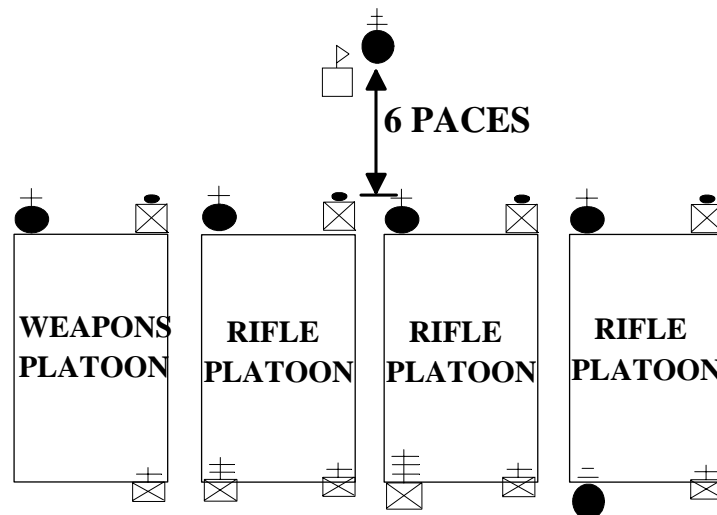

INTERVAL BETWEEN PLATOONS IS THE SAME AS
THE INTERVAL BETWEEN FILES OF THE PLATOON.

Figure 10-3.--Company Mass Formation.

10008. BEING IN COLUMN, TO FORM EXTENDED MASS FORMATION

1. At a halt or in march while in column, to form extended mass, the company commander orders **"Company Mass (3 to 6) Paces Left, MARCH."** On the preparatory command, platoon commanders give the following supplementary commands: leading platoon commander turns his/her head and eyes to the left and commands **"STAND FAST"** remaining platoon commanders turn their head and eyes to the left and command **"Column Half Left."** On the company commander's command of execution **"MARCH,"** the leading platoon stands fast, and the remaining platoons simultaneously execute a column half left. On commands from their platoon commanders, the remaining platoons then execute a column half right so as to move into positions alongside the leading platoon at the designated (3 to 6-pace) interval. As each platoon commander is about to come on line with the leading rank of the halted element, they turn their head and eyes to the right and command **"Mark Time, MARCH."** The platoon marks time 4-8 counts to gain cover and alignment and is halted by the platoon commander. This formation is used for drills and ceremonies if it is desired to increase the size of the mass in order to present a more impressive appearance. The company in this formation drills in the same manner as for mass formation, maintaining the specified interval between platoons and files in the platoons.

2. The company on the march in column at close or normal interval are given the same commands at the halt, except that on the preparatory command the leading platoon commander commands **"Mark Time."** On the company commander's command of execution **"MARCH,"** the leading platoon marks time 4-8 counts then halts on command of its platoon commander. The commands and movements for the remaining platoons are the same as for executing the movement from a halt.

3. If the company was in column at normal interval, then the company extended mass has normal interval between files in the platoons and the specified (3-6 pace) interval between platoons in the company. If the company was in column at close interval, then the company extended mass has close interval, 4 inches, between files in the platoons and specified (3-6 paces) interval between platoons in the company.

4. To form a company extended mass right use the same commands as in paragraph 10008.1 substituting left for right and right for left. However, forming a company into a mass right results in the platoons being inverted and should only be done under unusual circumstances.

e. If the unit is formed at extended mass by enlisted personnel as part of a larger formation the same procedures for posting as in paragraph 10002.2c(2).

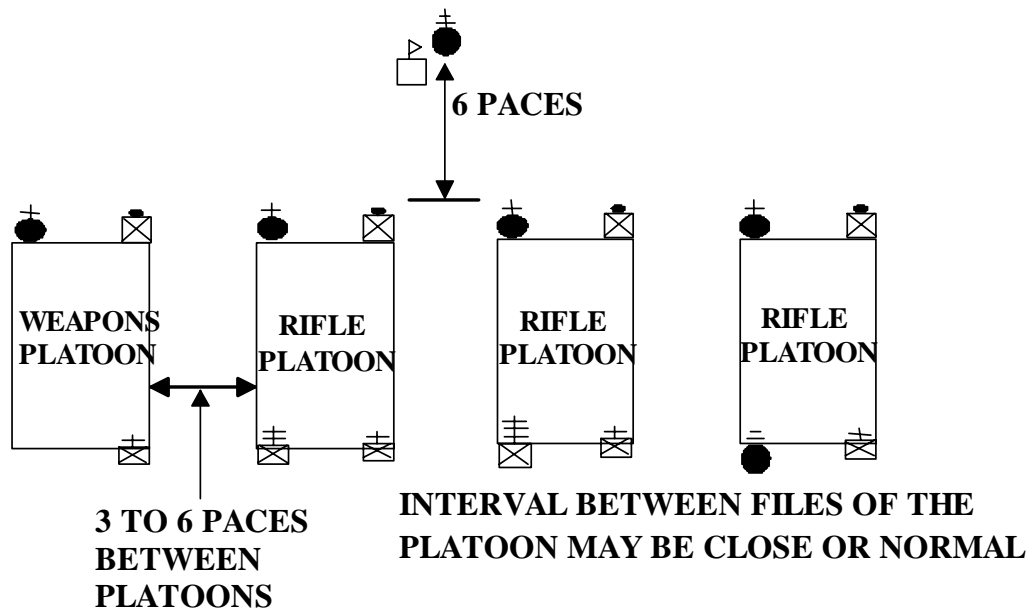

Figure 10-4.--Company in Extended Mass Formation.

10009. BEING IN MASS OR EXTENDED MASS FORMATION, TO CHANGE DIRECTION

1. Being in mass or extended mass formation at a halt or in march, to change direction 90 degrees to the right (left), the company commander commands **"Right (Left) Turn, MARCH"** and **"Forward, MARCH."** The right flank guide of the line of guides and platoon commanders is the pivot for this movement. At the command of execution **"MARCH,"** for the right (left) turn, the pivot faces to the right (left) in marching and takes up the half step. Other members of the first rank execute a right (left) oblique, advance until opposite their place in line, execute a second right (left) oblique, and upon arriving abreast of the pivot man, take up the half step. Each succeeding rank executes the movement on the same ground and in the same manner as the first rank. All take a full step at the command **"Forward, MARCH,"** which is given by the company commander after all members of the company have changed direction and have picked up the half step.

2. Being in mass or extended mass formation at a halt or in march, to change direction 45 degrees to the right (left), the company commander commands **"Half Right (Left) Turn, MARCH"** and **"Forward, MARCH."** This movement is executed in a similar manner for a right turn as described above, except that the pivot makes a half right (left) face in marching, and the members of each rank need execute only one right (left) oblique in marching.

10010. BEING IN MASS OR EXTENDED MASS FORMATION, TO FORM COLUMN

1. Being at a halt in mass or extended mass formation, to form column, the commands are **"Column of Threes (Fours), Right (Left) Platoon, Forward (Column Right), MARCH."** On the preparatory command, the platoon commanders give the following supplementary commands: right (left) platoon commander commands **"Forward (Column Right);"** and the remaining platoon commanders command **"STAND FAST."** On the company commander's command of execution **"MARCH,"** the right (left) platoon marches forward and the remaining platoons stand fast. When the leading platoon

reaches an appropriate point, the next platoon, on commands of its platoon commander, executes necessary column movements so as to take up the march in column at a distance of 4 paces from the leading platoon. Remaining platoons in succession, take up the march in column at distances of 4 paces in a similar manner.

2. Being on the march in mass or extended mass formation, to form a column, the company commander gives the same command as when initiated from a halt. In this case, on the preparatory command, the right (left) platoon commands "**Continue to March (Column Right),**" and the remaining platoon commanders command "**Mark Time.**" On the company commander's command of execution "**MARCH,**" the right (left) platoon continues the march (executes a column right) and the remaining platoons mark time. The platoon commanders of the remaining platoons cause their platoons to execute necessary column movements so as to follow in column behind the leading platoon at a 4-pace distance in a similar manner as when the movement is initiated from a halt.

10011. BEING IN COLUMN, TO FORM COLUMN OF PLATOONS IN LINE

1. Being at a halt and at the order in column, to form column of platoons in line the company commander commands "**Column of Platoons in Line, MARCH**" and "**Left, FACE.**" On the first preparatory command, platoon commanders give the following supplementary commands: leading platoon commander commands "**STAND FAST;**" second platoon commander commands "**Column Right,**" and all other platoon commanders commands "**Forward.**" On the company commander's command of execution "**MARCH,**" the leading platoon stands fast, the second platoon executes a column right and marches 12 paces past the right file of the leading platoon, then, on command of its platoon commander, executes a column left, and marches forward until its front rank is on line with the front rank of the leading platoon (now on its left), marks time 4-8 counts, and halts. Succeeding platoons march forward, executing a column right on the same ground as the leading platoon, then a column left, and finally marking time 4-8 counts and halting on line on commands of their platoon commanders so as to be at 12-pace intervals. When all platoons are halted on line, the company commander commands "**Left, FACE.**" All platoons execute a left face with each platoon commander moving by the most direct route to their post 6 paces front and center of the platoon, and each platoon guide takes post on the right of the front rank of each platoon; the company is then formed in column of platoons in line with 12-pace distances between platoons. The formation may be used for inspections and for the display of equipment.

2. Being on the march in column, to form column of platoons in line, the commands are "**Column of Platoons in Line, Leading Platoon by the Left Flank, MARCH.**" On the preparatory command, platoon commanders give the following supplementary commands: the leading platoon commander commands "**By the Left Flank;**" the remaining platoon commanders command, "**Continue to March.**" Simultaneously, on the preparatory command, all platoon commanders incline to the left from their posts in column and half step so as to be as near as possible to a position 6 paces from and centered on the left file of their platoons prior to the company commander's command of execution "**MARCH.**" At that command, the leading platoon executes a left flank march, its guide moving abreast of the front rank as rapidly as possible; succeeding platoons continue the march forward and, on commands of their platoon commanders, execute a left flank on the same ground and in the same manner as the leading platoon. Each platoon commander, after executing a left flank march, marches at a position 6 paces front and center of the platoon, and the company

commander, guidon bearer, and company staff march in positions. In this formation, which may be used for passing in review during ceremonies, the company marches in column of platoons in line, with the distance between each platoon equal to the length of each platoon plus 4 paces.

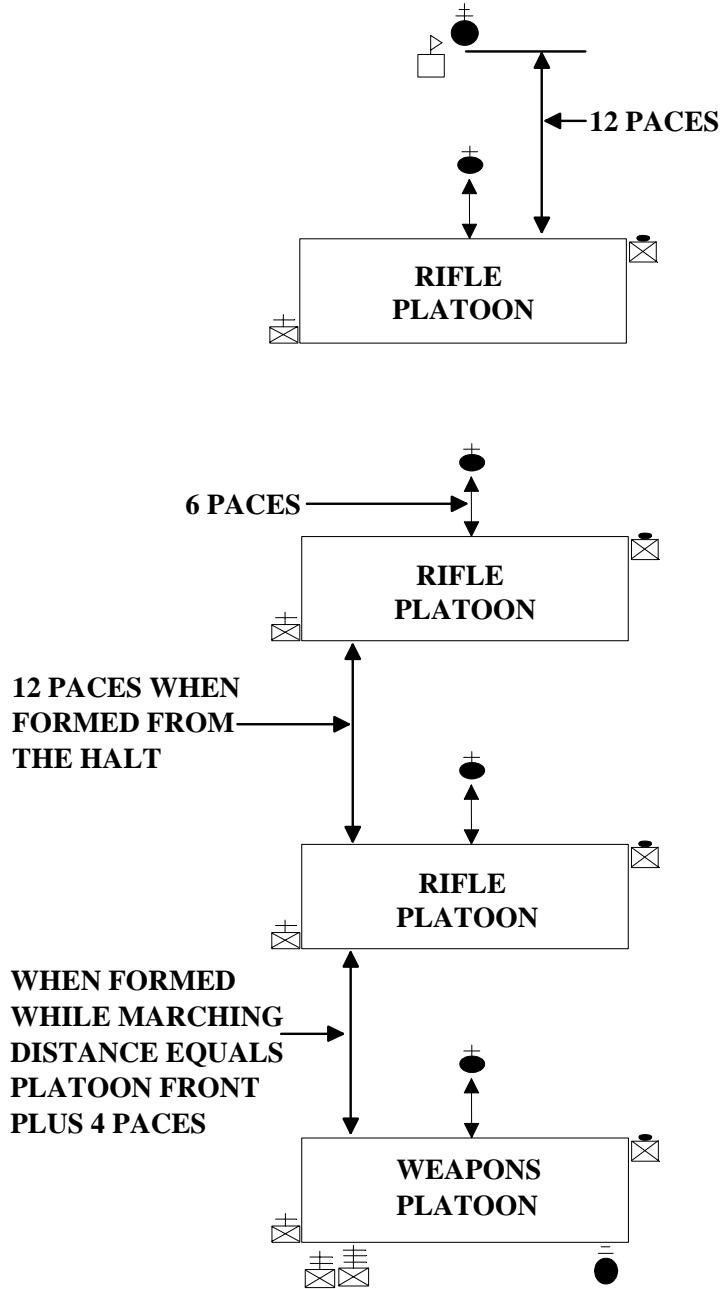

Figure 10-5.--Column of Platoons in Line Formation.

10012. BEING IN COLUMN OF PLATOONS IN LINE, TO FORM COLUMN

1. Being halted at the order in a column of platoons in line, to form column, the company commander commands **"Right, FACE,"** at which time all platoons face to the right with platoon commanders and guides taking posts at the head of the left and right files respectively of their platoons. Next, the company commander orders **"Column of Threes (Fours, etc.), Left Platoon, Forward (Column Left), MARCH."** Thereafter, commands and procedures for executing this movement are the same as prescribed for forming a column from a mass or extended mass formation from the halt in paragraph 10010.

2. While in a column of platoons in line, to form column, the commands are: **"Column of Threes (Fours, etc.), Leading Platoon, By the Right Flank, MARCH"** or **"Column of Threes (Fours, etc.), Leading Platoon by the Right Flank, Column Left, MARCH."** On the preparatory command, platoon commanders give the following supplementary commands: the lead platoon commander commands **"By the Right Flank (By the Right Flank, Column Left);"** remaining platoon commanders command, **"Continue to March."** On the company commander's command of execution **"MARCH,"** the leading platoon executes a right flank (right flank, column left). Succeeding platoons continue to march forward, each, on the command of its platoon commander, executing a right flank (right flank, column left) on the same ground as the leading platoon, then following in trace of the leading platoon in column at 4-pace distances. Officers, key noncommissioned officers, and the company guidon move by the most direct routes to their proper positions in column.

NOTE: In forming column from column of platoons in line at a halt or while marching, movements should always be made in the directions indicated above, otherwise platoons and squads become inverted.

10013. BEING IN COLUMN, TO FORM COLUMN OF TWOS OR FILES AND REFORM

1. Being at a halt in column, to form column of twos (files), the company commander commands **"Column of Twos (Files) from the Right (Left), MARCH."** On the preparatory command, platoon commanders and squad leaders give the following supplementary commands: leading platoon commander commands **"Column of Twos (Files) from the Right (Left),"** after which the squad leaders of the leading platoon give appropriate supplementary commands to form the movement required as prescribed in paragraph 9025; the remaining platoon commanders command **"STAND FAST."** On the company commander's command of execution **"MARCH,"** the leading platoon marches forward in column of twos (files) as prescribed in platoon drill. Succeeding platoons march forward in column of twos (files) on the commands of their platoon commanders and squad leaders in the same manner as the leading platoon so as to follow the leading platoon in column at 4-pace distances.

b. Being at a halt in column of twos (files), to reform column (e.g., column of threes, etc.), the company commander commands **"Column of Threes (Fours, etc.) to the Left (Right), MARCH."** On the preparatory command, the platoon commanders and squad leaders give the following supplementary commands: leading platoon commander commands **"Column of Threes (Fours, etc.) to the Left (Right),"** after which the squad leaders of the leading platoon give appropriate supplementary commands as prescribed in paragraph 9025; the remaining platoon commanders command **"STAND FAST."** On the company commander's command of execution **"MARCH,"** the leading platoon marches forward in column (of threes, etc.) as prescribed in platoon drill. Succeeding platoons march forward in column (of threes) on the commands of their platoon commanders and squad leaders in the same manner as the leading platoon so as to follow the leading platoon in column at 4-pace distances.

10014. COMPANY AWARDS FORMATIONS

1. The ceremonies that are normally conducted at the company level are, but not limited to, the following:

- a. Promotions
- b. Awards
- c. Reenlistments
- d. Special Recognition

2. The company formation normally used for company ceremonies is the Company in Line.

3. The first sergeant forms the company in line with those personnel to receive awards, promotions, etc., forming a single rank behind the last squad of the first platoon. (See figure 10-6.) They are arranged in reverse sequence of presentation priority, to ensure that they are presented to the company commander in the appropriate sequence. (e.g., The junior award recipient would be first in line to march out.) The priority sequence will normally be:

- a. Personal decorations and awards. (e.g., Navy-Marine Corps Achievement Medal, Meritorious Mast, and Letters of Appreciation)
- b. Promotions.
- c. Reenlistments.
- d. Service Awards. (e.g., Good Conduct Medal)
- e. Other certificates (e.g., discharge certificate, MCI completion, etc.)
- f. Retirements if performed on the company level should be a separate ceremony, conducted in the same manner.

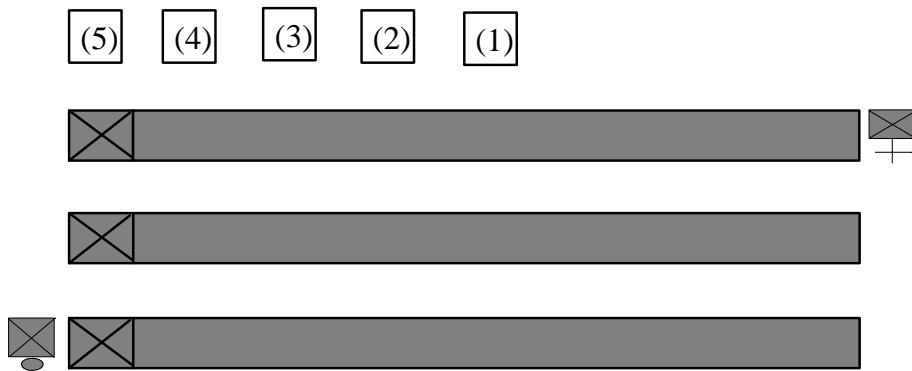

Figure 10-6.--Placing of Award Recipients for the Ceremony.

4. The company is formed as depicted in paragraph 10002. After the first sergeant receives the report from the platoon sergeants he/she faces about and waits for the company commander to take the formation. The first sergeant executes a hand salute and reports the company to the company commander. The company commander returns the salute, and commands **"TAKE YOUR POST."**

→ a. At this command, rather than taking his/her normal post at the rear of the company, the first sergeant will step off in the left oblique and march around the commander's right, and continuing to march until he/she has positioned himself/herself 1 pace to the left and 1 pace to the rear of the company commander. (See figure 10-7.) Platoon commanders take their post centered on their platoons, platoon sergeants post as shown in figure 10-7 and the guidon bearer takes 3 paces forward. For company awards formations, the company guidon bearer will not take 3 steps forward upon the command **"TAKE YOUR POST."**

→ b. The first sergeant will then command **"Persons to be Decorated (be Promoted, Reenlisted, etc.), Front and Center, MARCH."**

→ (1) On the command of **"Front and Center,"** the Marines receiving awards execute a right face.

(2) On the command **"MARCH,"** the award recipients will step off and continue to march until they have cleared the guide of the first platoon. The senior Marine receiving an award will then command **"Column Left, MARCH."** (See figure 10-7.)

(3) They will continue to march to a position that places them at a point half way between the line of platoon commanders and the company commander. The senior Marine will then command **"Column Left, MARCH."**

(4) They will continue to march on this line until the rank of award recipients is centered on the company commander, at which time the senior Marine will command **"Mark Time, MARCH;" "Detail, HALT;" "Right, FACE;"** and **"Hand, SALUTE."** (See figure 10-7.)

c. After the commander has returned the salute, the senior Marine will then command **"Ready, TWO."**

5. The first sergeant or narrator, if one is used, will then read the first citation or warrant. The commander and the first sergeant will then step off and march directly to the first Marine and halt, so the commander is directly in front. The first sergeant will pass the award or warrant to the commander who will then present it to the Marine. After the Marine receives his/her citation the commander and the first sergeant will face to the right as in marching, and march until the commander is in front of the next Marine, halt, and execute a left face. The first sergeant or narrator will read the next citation and the commander will present it. They will continue until the last award or citation is presented. They will then face to the right as in marching, and march in the most direct route to their original positions.

6. Once the company commander and first sergeant are back in position, the first sergeant will then command **"POST."** On the command **"POST,"** the senior Marine will command **"Hand, SALUTE."** The entire detail will execute. After the commander returns the salute, the senior Marine commands **"Ready, TWO"** followed by **"Left, FACE."**

Enclosure (1)

7. The first sergeant then commands **"Forward, MARCH."** On the command of execution **"MARCH,"** the award recipients under the command of the senior Marine will march forward until they are at a position past the platoon sergeant of the last platoon and command **"Column Left, MARCH."** They will continue to march until they are 1 pace past the last rank of the last platoon, the senior Marine will then command **"Column Left, MARCH."** They will continue to march to a position behind the last rank. The senior Marine will then command **"Mark Time, MARCH;" "Detail, HALT;" "Left, FACE."** (See figure 10-7.)

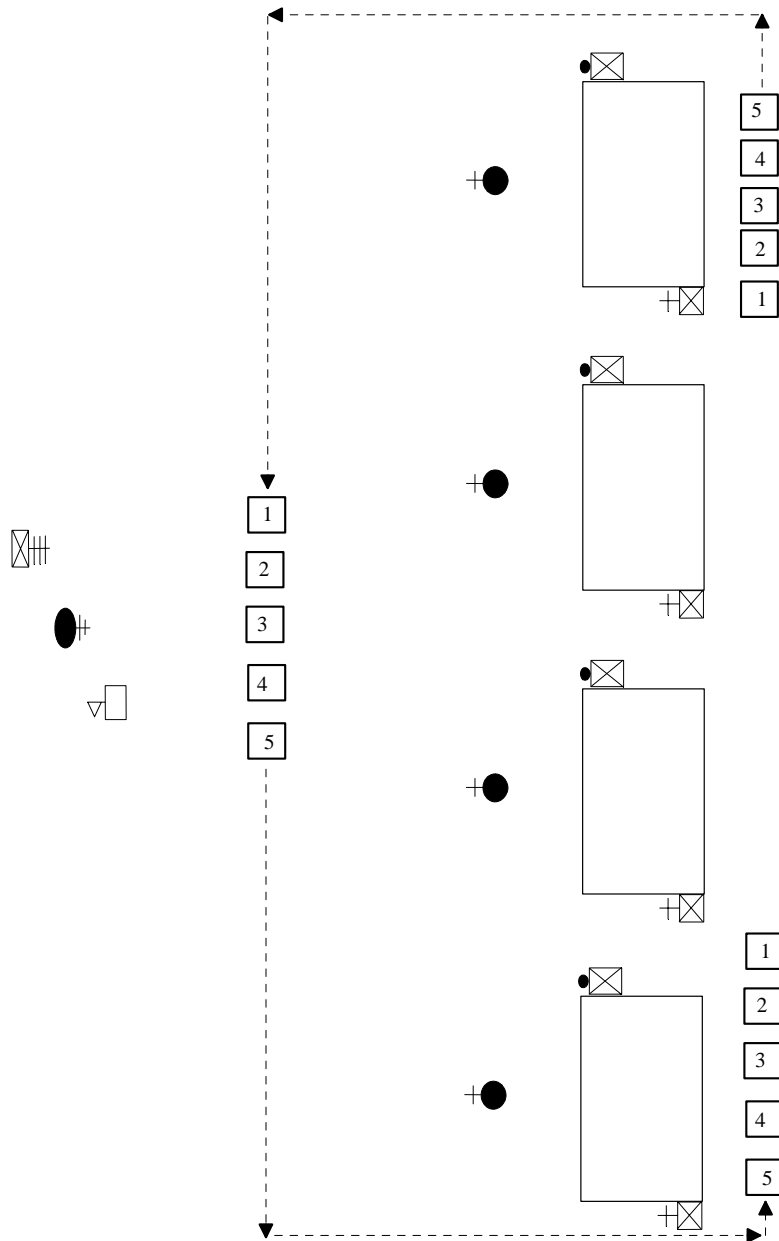

Figure 10-7.--Movements of the Award Recipients.

8. This completes the ceremony. The company commander would then dismiss the company or carries out the plan of the day.

9. When promoting a number of Marines to the same grade, it is appropriate to read only one warrant, inserting all of the names of the Marines being promoted at the appropriate place. However, one warrant is read for each grade being promoted (e.g., one warrant read for the two sergeants, another warrant read for the five corporals, etc.) Additionally, for good conduct medals it is appropriate to read only one citation for all hands receiving the medal, reading the name and number of awards at the appropriate place for all Marines.

MARINE CORPS DRILL AND CEREMONIES MANUAL

PART I: DRILL

CHAPTER 11

BATTALION DRILL

	<u>PARAGRAPH</u>	<u>PAGE</u>
GENERAL	11000	11-3
RULES FOR BATTALION DRILL	11001	11-4
TO FORM FOR ROUTINE FORMATIONS	11002	11-5
TO FORM FOR INSPECTIONS, DRILLS, MARCHES, OR PRIOR TO PARTICIPATION IN LARGER MARCHES OR CEREMONIES	11003	11-5
TO FORM IN LINE WITH COMPANIES IN LINE FOR BATTALION FORMATIONS AND CEREMONIES	11004	11-6
TO FORM IN LINE WITH COMPANIES IN MASS (EXTENDED MASS) FORMATION FOR BATTALION FORMATIONS AND CEREMONIES	11005	11-10
TO FORM BATTALION IN MASS	11006	11-13
BATTALION IN COLUMN WITH COMPANIES IN COLUMN	11007	11-14
BATTALION IN COLUMN OF COMPANIES WITH COMPANIES IN LINE . . .	11008	11-16
TO DISMISS THE BATTALION	11009	11-17

FIGURE

11-1	BATTALION IN LINE WITH COMPANIES IN LINE	11-6
11-2	GUIDE ON LINE	11-7
11-3	PLATOON HALT	11-8
11-4	GUIDES POST	11-8
11-5	MODIFIED BATTALION IN LINE WITH COMPANIES IN LINE . .	11-9
11-6	BATTALION IN LINE WITH COMPANIES IN MASS FORMATION. .	11-10
11-7	GUIDE OF THE RIGHT PLATOON ON LINE	11-10
11-8	FORMING A COMPANY MASS LEFT	11-12
11-9	MODIFIED BATTALION IN LINE WITH COMPANIES IN MASS FORMATION	11-12
11-10	BATTALION IN MASS FORMATION	11-13

MARINE CORPS DRILL AND CEREMONIES MANUAL

	<u>PAGE</u>
11-11 MODIFIED BATTALION IN MASS FORMATION	11-14
11-12 BATTALION IN COLUMN OF COMPANIES WITH COMPANIES IN LINE	11-15
11-13 BATTALION IN COLUMN WITH COMPANIES IN COLUMN	11-16

MARINE CORPS DRILL AND CEREMONIES MANUAL

PART I: DRILL

CHAPTER 11

BATTALION DRILL

11000. GENERAL

1. The formations described in this Chapter pertain to the infantry battalion. Using them as a guide, other units of corresponding size conform as appropriate.
2. Formations used by the battalion are: battalion in line with companies in line; battalion in column (of threes, etc.) with companies in column; battalion in line with companies in mass formation; battalion in mass formation; and battalion in column of companies with companies in line. In all these formations, the platoons that comprise the company will either be in line (each squad forming one rank) or in column (each squad forming one file). The battalion may also form column of twos or files in a manner similar to that prescribed for a company, in which case the companies are arranged as in column, except that each company is in column of twos or files. Formations of the battalion for drill and ceremonies, to include posts of officers and key staff noncommissioned officers, are shown in figures 11-1 through 11-13.
3. When the battalion commander is absent, the senior officer present with the battalion posts and drills the battalion as prescribed for the battalion commander. In the absence of the sergeant major, the senior noncommissioned officer posts and performs the duties of the sergeant major.
4. When officers are not present, after the battalion is formed, the sergeant major, or in his/her absence, the next senior staff noncommissioned officer posts and drills the battalion as prescribed for the battalion commander, and first sergeants posts and perform the duties of the company commanders. This also applies when, for any reason, the battalion commander directs the sergeant major (or senior staff noncommissioned officer) to take charge of the battalion for purposes other than dismissing the battalion. When this occurs, the officers retire and the sergeant major and first sergeants march by the most direct route to take post as the battalion commander and company commanders, respectively.
5. When practicable, the formation and movement of the subdivisions of the battalion should be made clear to subordinate commanders before starting the movement.
6. The battalion drills by command for formations and ceremonies where units of the battalion execute the manual, facings, and marching as one body at the command of execution of the battalion commander. The battalion in a manner similar to that prescribed for the company executes these movements.
7. To assume any formation, the battalion commander indicates the formation desired the point where the right (left) of the battalion is to be, and the direction in which the line or column is to face. Formations should be such that, in approaching the line on which the battalion forms, columns and lines are either perpendicular or parallel to the front.
8. Upon completing the movement ordered by the battalion commander, companies may be given "AT EASE" until another movement is ordered. After a ceremony has started, units remain at attention until ordered to stand at parade rest or at ease by the battalion commander or adjutant.

9. After a battalion is halted, its subdivisions make no movement to correct alignment or position unless so directed by the battalion commander.
10. When the battalion is presented to its commander or to a reviewing officer, the officer who makes the presentation faces the battalion and commands **"Present, ARMS."** When all elements of his/her unit are at present arms, he/she faces the front and salutes. Members of his/her staff salute and terminate the salute with him/her.
11. When the battalion commander does not take the formation, the executive officer (or in his/her absence, the next senior officer) is commander of troops. The commander of troops takes post, gives all commands, and receives all salutes prescribed for the battalion commander.
12. For close-order drill, marches and physical fitness training, the battalion headquarters command group is formed as directed by the battalion commander.
13. During battalion physical training and conditioning marches when the battalion is in column, the sergeant major will move from his/her normal position with the staff and assume a position to the left of the battalion commander. Normally the organizational colors are not carried during physical training or conditioning marches. However, if the battalion commander directs that they be taken they will form immediately to the rear of the battalion commander.

11001. RULES FOR BATTALION DRILL

1. The commands or orders of the battalion commander are given by voice, by bugle, by signal, or by means of staff officers or messengers who communicate them to commanders concerned.
2. Company commanders and platoon commanders give supplementary commands in the same manner as prescribed for company drill (see paragraph 10001).
3. The color guard is posted to the left of the color company when the company is in line and in rear when the company is in column. The color company is posted in the battalion formation so that the color guard is in the approximate center of the formation (right or forward of center, if this is impossible). The color guard may be omitted for daily battalion formations.
4. The adjutant posts the band when present.
5. Attached units take position as directed by the battalion commander and conform to the formation and movements of the battalion.
6. In whatever direction the battalion faces, the companies are designated numerically from right to left in line and from front to rear in column; that is, first company, second company, third company, etc.
7. The terms "right" and "left" apply to actual right and left as the troops face.
8. The designation "center company" indicates the right center or the actual center company, according to whether the number of companies is even or odd.
9. Personnel of the battalion Headquarters and Service Company may be attached to other companies of the battalion for ceremonies.

10. The battalion commander supervises the formation from such positions as will best enable him/her to correct alignments, intervals, and distances. With his/her staff (less the adjutant), he/she takes post in time to receive the report. The position of the staff may be modified during daily battalion formations.

11. For daily battalion formations at which promotions or awards will be effected the procedures for company awards ceremonies may be used (see paragraph 10014).

12. Any formation or combination of formations may be employed to meet existing conditions of space or purpose. Spacing between elements may also be adjusted as necessary.

11002. TO FORM FOR ROUTINE FORMATIONS

1. The following are the standard procedures for forming of the battalion for routine formations using modifications to standard formations as shown in figures 11-5, 11-9, and 11-11. These modified formations are normally used to form the battalion for daily formations for passing the word, promotion or award formations, or prior to battalion physical training and conditioning marches.

a. The companies are formed by their staff noncommissioned officers/noncommissioned officers and/or officers at their designated location as prescribed for company drill (see paragraph 10002.) Company commanders then position their companies in the prescribed formation where the battalion is to form. If the colors are to be carried the color guard and color company first receives the battalion colors (see paragraph 7302), then take their position in formation.

b. The battalion staff will be posted to the right of the lead company as shown in figures 11-5, 11-9, and 11-11 under the command of the battalion executive officer.

c. If the battalion is formed by enlisted personnel the procedures for reporting and posting for company drill (see paragraph 10002) will be used by the sergeant major and first sergeants. The staff will remain at ease until the battalion commander has assumed his/her position and is ready to receive the report from the sergeant major, at which time the staff will come to "ATTENTION."

11003. TO FORM FOR INSPECTIONS, DRILLS, MARCHES, OR PRIOR TO PARTICIPATION IN LARGER MARCHES OR CEREMONIES

1. The following are the standard procedures for a ceremonial forming of the battalion for those formations shown in figures 11-1, 11-6, 11-10, 11-12, and 11-13.

a. At "Assembly" the companies are formed by their staff noncommissioned officers/noncommissioned officers and officers at their designated locations as prescribed for company drill (see paragraph 10002). Company commanders then position their companies in the prescribed formation where the battalion is to form. If the colors are to be carried the color guard and color company first receives the battalion colors (see paragraph 7302), then take their position in formation.

b. The adjutant takes post 6 paces to the right of and facing where the right flank of the battalion will rest when forming in line (or 6 paces in front of and facing the leading guide of the leading company in column) draws sword if so armed, and supervises the positioning of the companies.

- c. If a band or bugler is not present at the time for "*Adjutant's Call*," the adjutant marches by the most direct route to a position midway between the line of company commanders and battalion commander when in line (or midway between the leading company commander and battalion commander in column), faces the battalion, and commands "**Battalion, ATTENTION.**" The adjutant then faces the battalion commander, salutes and reports, "Sir/Ma'am, the battalion is formed." The battalion commander returns the salute and orders "**TAKE YOUR POST.**" The adjutant passes to the battalion commander's right and takes his/her post in the staff. The battalion commander and staff then draw swords, if so armed and execute order sword. Then appropriate commands are given to conduct the inspection, drill, or march (If forming prior to participation in regimental or larger marches or ceremonies, the battalion awaits the second, or regimental "*Adjutant's Call*."
- d. If a band is present, in lieu of bringing the battalion to attention by voice command, the adjutant may direct "**Sound, ATTENTION.**" After "*Attention*" is sounded, the companies are brought to attention in succession from right to left when in line (front to rear in column), but remain at the order. Next, the adjutant orders "**Sound, ADJUTANT'S CALL.**" Companies stand fast while "*Adjutant's Call*" is sounded. The adjutant then takes post midway between the line of company commanders and battalion commander when in line (midway between the drum major and battalion commander when in column) and reports that the battalion is formed.

11004. TO FORM IN LINE WITH COMPANIES IN LINE FOR BATTALION FORMATIONS AND CEREMONIES

1. The following are procedures for the ceremonial forming of a battalion line with companies in line. Figure 11-1 depicts this formation.

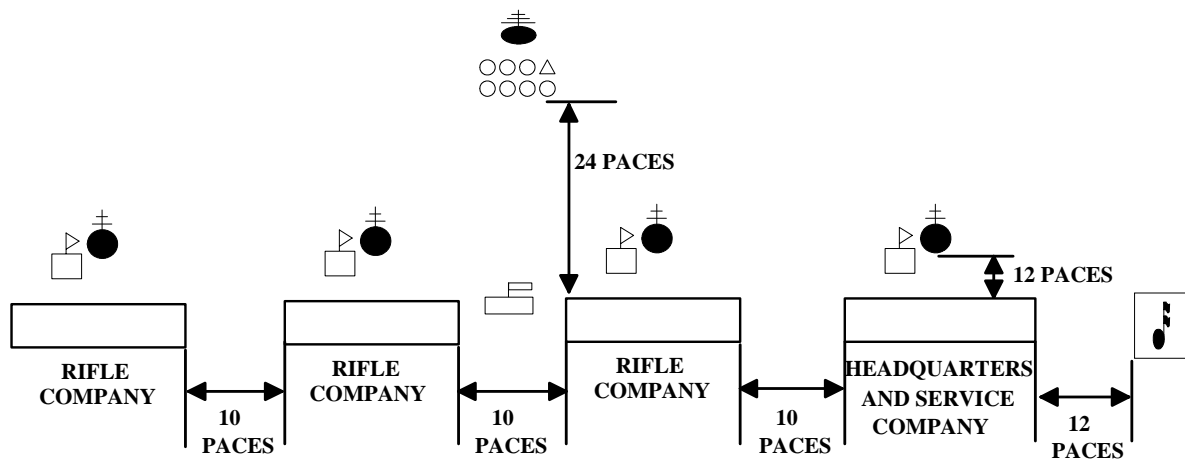

Figure 11-1.—Battalion in Line with Companies in Line.

1. At "*Assembly*" the companies are formed by their staff noncommissioned officers/noncommissioned officers and officers at their designated locations as prescribed in company drill (see paragraph 10002). The color guard and color company, after forming, receives the battalion colors (see paragraph 7302). The companies remain at their locations for assembly, or if directed by the battalion commander, move to positions closer to the battalion parade ground and await "*Adjutant's Call*" to form the battalion for the ceremony.

Enclosure (1)

b. The adjutant indicates the line on which the battalion is to form with two dress guidons on each flank. He/she takes post on the line 6 paces from and facing where the right flank of the battalion will rest, and draws sword if so armed. When the band is present, at the designated time the adjutant orders the band to **"Sound, ATTENTION."** At the sounding of "Attention," the companies are brought to attention and to right shoulder arms from front to rear or from right to left. After the entire battalion is at attention and at right shoulder arms, the adjutant orders the band to **"Sound, ADJUTANT'S CALL."**

c. Companies are marched from the left flank of the parade field in column of threes (or fours) so as to arrive at positions on the line of troops successively from right to left. The command of execution for their movement is so timed that they will step off at the first note of the march following "Adjutant's Call."

(1) As the company commander and guide arrive at a position abreast of their position in formation they execute a left flank, march forward to their positions and halt. The guide goes to order guidon; the company commander faces about towards the company and remains at carry sword, if so armed.

(2) As each platoon approaches its position on the line, the platoon commander orders **"GUIDE ON LINE."** The platoon guide goes to port arms and double times to a position to the left of where the platoon's squad leaders will halt, halts facing the adjutant, and goes to order arms. (See figure 11-2.)

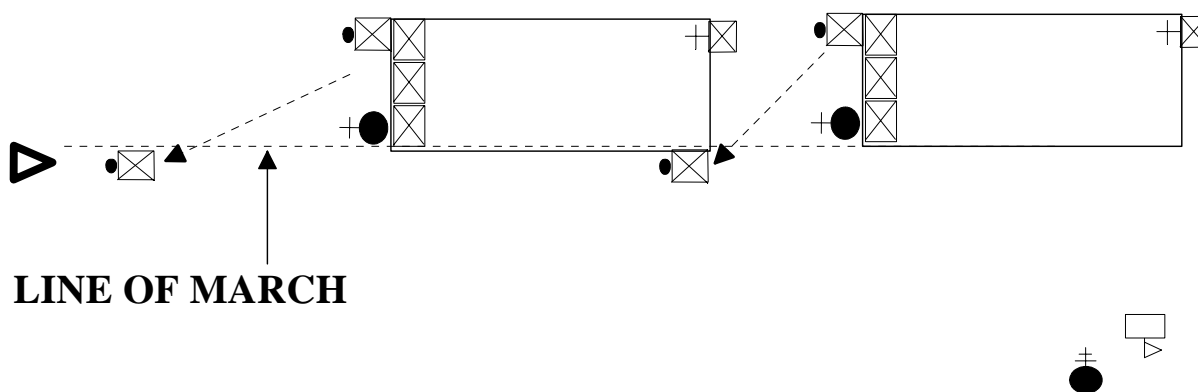

Figure 11-2.--Guide on Line.

(3) The company commander then gives the command **"Mark Time, MARCH"** so that the left squad leaders mark time beside the platoon guides. After 4-8 counts of mark time the company commander gives the command **"Company, HALT."** (See figure 11-3.) Once all platoons are halted the company commander gives the command to **"Order, ARMS;"** however, the platoon commander and platoon sergeant remain at carry sword, if so armed. The company commander then commands, **"Left, FACE."** The platoons, except for the guides, face to the left. Platoon sergeants go to order sword, if so armed. Platoon commanders, after facing left move to their position 6 paces in front of and centered on the platoon, halts from the oblique, with the platoon to his/her rear, and goes to order sword.

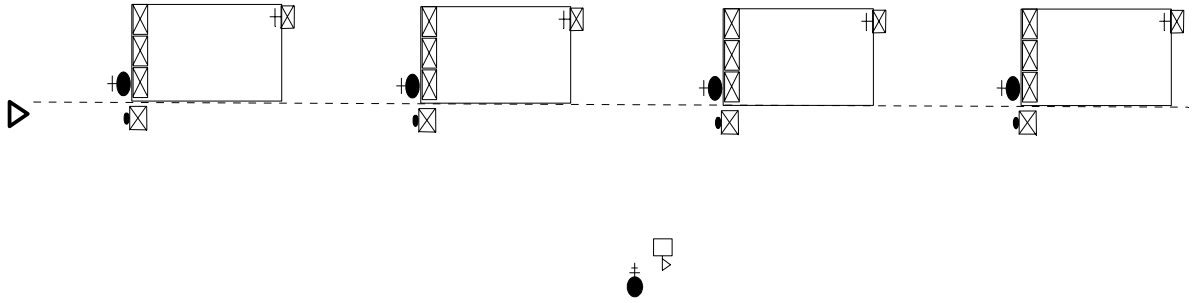

Figure 11-3.--Platoon Halt.

(4) When all platoon commanders are in position and at order sword the company commander commands "**DRESS RIGHT.**" Platoon commanders go to carry sword, face their platoons, and in sequence from right to left, command, "**Dress Right, DRESS.**" The platoons are aligned as indicated in paragraph 9009. When the platoon commanders have finished aligning their platoons they command "**Ready, FRONT**" and "**COVER,**" move back to their positions 6 paces and centered on their platoons, halt from the oblique, with the platoon to his/her rear, and goes to order sword. The company commander faces about and goes to order sword, if so armed.

d. On the command of "**FRONT,**" by the first platoon commander in the line the adjutant moves by the most direct route to a position midway between the line of company commanders and the battalion commander and faces the battalion. After all units have finished dressing right, the adjutant commands "**Guides, POST.**" At the command "**POST,**" the guides move to their normal positions in ranks. To do this, the guides take one step forward, then take one step to the right, halts and execute an about face. (See figure 11-4.) If prescribed for the ceremony, the adjutant next commands "**Fix, BAYONETS.**" After fixing bayonets, or after posting the guide if bayonets are not fixed the ceremony proceeds as for a parade in chapter 15, a review in chapter 16, or for any formation as appropriate.

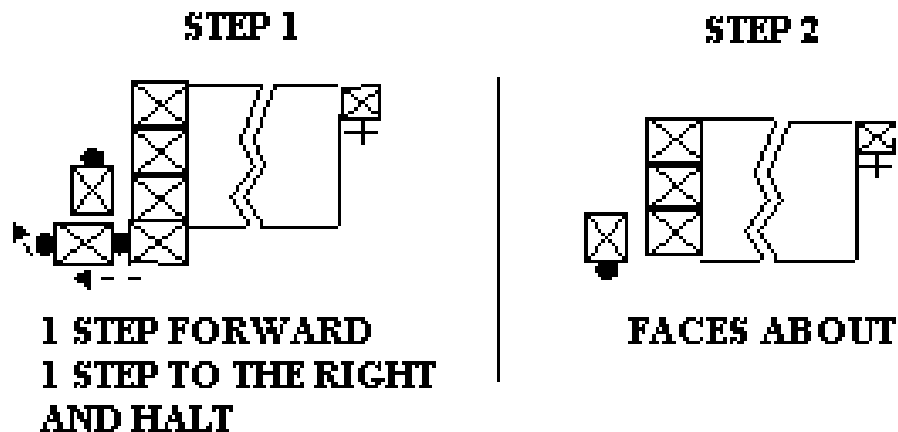

Figure 11-4.--Guides Post.

e. In the case of well-drilled and rehearsed troops, executing the movement **"GUIDE ON LINE"** and **"Guides, POST"** may be deleted. The formation would march to position on the line of troop, mark time, halt, face left, order arms and dress right.

f. If space or circumstances require, after forming at "Assembly," the companies may be directed to take their positions on the line of troops prior to "Adjutant's Call". In this case, procedures are as described above, except when "Attention" is sounded companies remain at order arms after being brought to attention, and at "Adjutant's Call" the companies stand fast (guides are not put on line). The adjutant then marches from the right of the line to his/her post front and center of, and facing the battalion. He/she causes the companies to dress to the right, fix bayonets (if prescribed), and the ceremony to proceed according to the type being conducted.

2. Figure 11-5 depicts modifications to the standard formation battalion in line with companies in line. The following procedures apply.

a. March on is normally omitted and the battalion forms by companies at a pre-designated location.

b. Enlisted personnel normally form the formation.

c. The staff forms to the right of the first company under the command of the battalion executive officer. The adjutant remains with the staff.

d. The color guard may be omitted.

e. Spacing and positioning of companies may be adjusted by the battalion commander to fit existing space or conditions.

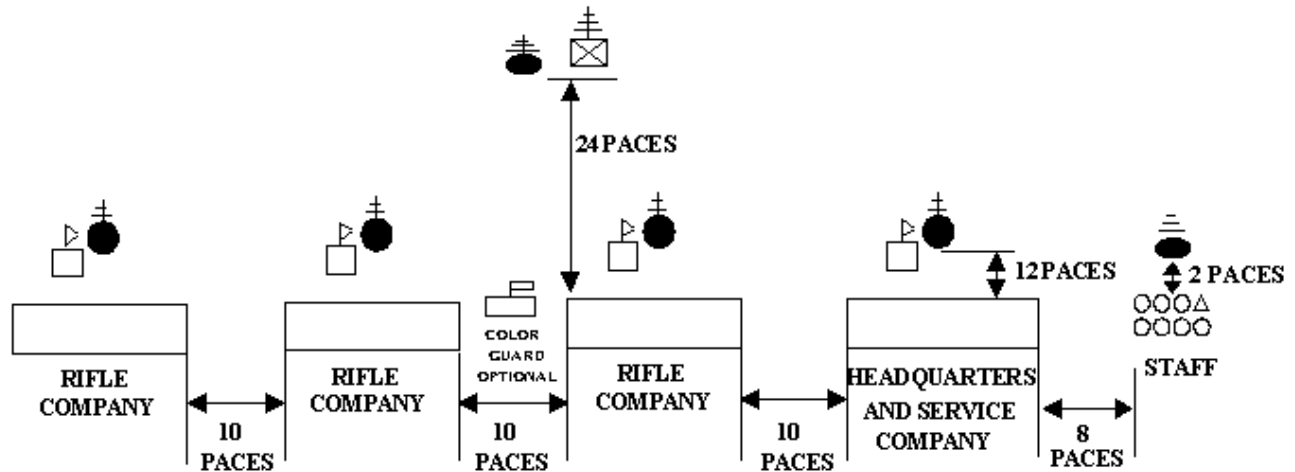

Figure 11-5.--Modified Battalion in Line with Companies in Line.

11005. TO FORM IN LINE WITH COMPANIES IN MASS (EXTENDED MASS) FORMATION FOR BATTALION FORMATIONS AND CEREMONIES

1. Figure 11-6 depicts battalion in line with companies in mass formation. For the ceremonial forming the procedure is the same as in forming in line except that when marching on at "Adjutant's Call."

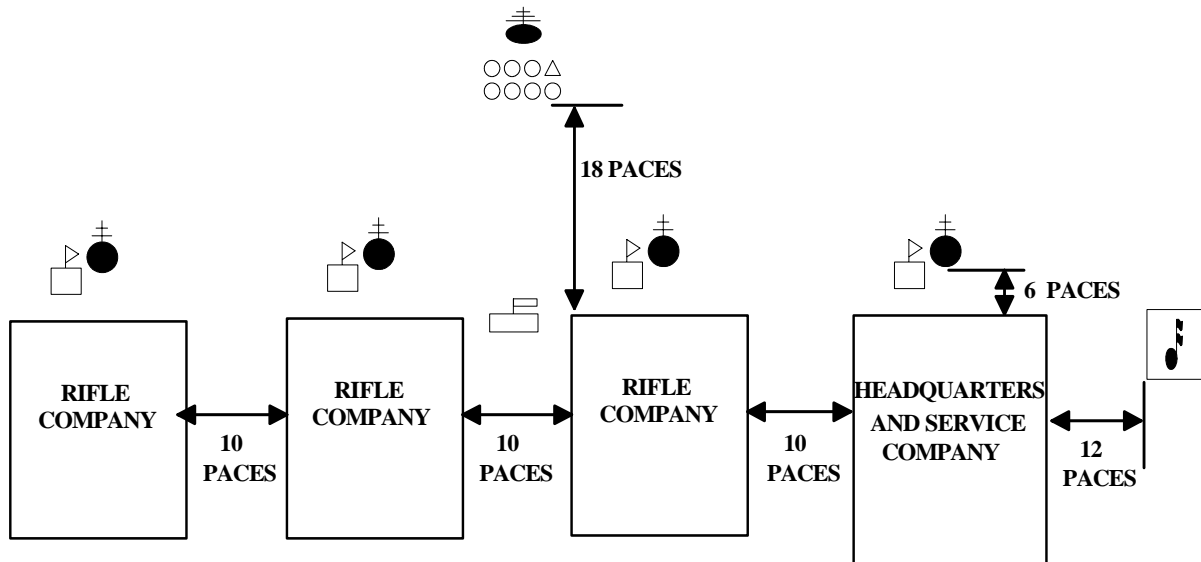

Figure 11-6.--Battalion in Line with Companies in Mass Formation.

a. Companies are marched from either flank in mass formation to their positions in line, the line of march being well in rear of the line on which the battalion is to form. When opposite its place in line, each company executes "Left (Right) Turn, MARCH." As soon as this turn has been initiated, the company commander commands "GUIDE OF RIGHT PLATOON ON LINE." At this command, the guide of the right platoon moves out at double time (at port arms) to the line indicated by the dress guidons, halts, goes to order arms, and faces the adjutant. (See figure 11-7) The guide indicates the right of the company.

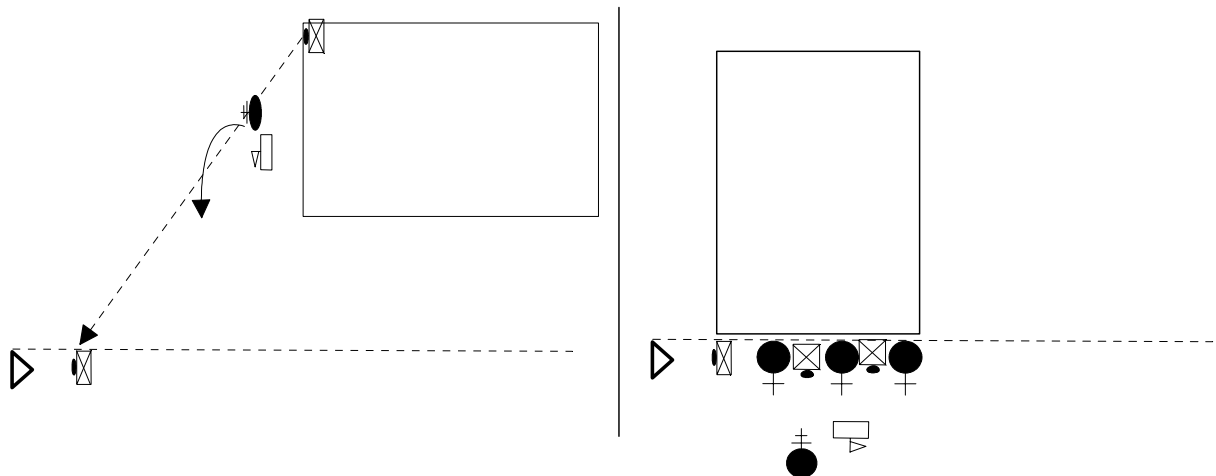

Figure 11-7.--Guide of the Right Platoon on Line.

b. The company continues to march forward towards the line of troops. When approaching the company's position the company commander commands **"Mark Time, MARCH."** The company marks time 4-8 steps to obtain cover and alignment. The right squad leader marks time so as his/her chest is lightly touching the right elbow of the guide. The company commander and guide, after reaching their position, halt. The guide goes to order guidon. The company commander faces the company and gives the command **"Company, HALT."** The company commander while facing the company and commands **"Order, ARMS"** and **"Dress Right (At Close Interval, Dress Right), DRESS."** The first platoon commander aligns the company as described in paragraph 10005. When the platoon commander is back in position and at order sword, if so armed, the company commander commands **"Ready, FRONT"** and **"COVER."** The company commander then faces about and goes to order sword, if so armed.

c. On the command of **"FRONT,"** by the first company commander in line the adjutant moves by the most direct route to a position midway between the line of company commanders and the battalion commander and faces the battalion. After all units have finished dressing right, the adjutant commands **"Guides, POST."** At the command **"POST,"** the guides move to their normal positions in ranks. To do this, the guides take one step to the left, in marching, and halt at order arms.

2. Companies may be marched to positions in column of threes (or fours) instead of in mass formation as above. The procedure is the same as above except that:

a. When the company commander and guide come abreast of the right flank of where the company will come to rest in the line of troops the company commander commands **"Column Left, MARCH."** The company commander, guide and leading platoon execute the column left. As soon as the column movement has been initiated, the company commander orders **"GUIDE OF LEADING PLATOON ON LINE."** The guide moves out to his/her position on the line as described in 11004.1. The company commander then commands, **"Company Mass Left (Company Mass 3-6 Paces Left), MARCH."**

(1) The lead platoon commander as he/she approaches the guide, gives the command **"Mark Time, MARCH."** The right squad leader marks time so as his/her chest is lightly touching the right elbow of the guide. The remaining platoons, when abreast of their position, successively execute a column left and move into position on the left of the leading platoon at the designated interval and mark time at the command of their platoon commander. (See figure 11-8.)

(2) The company commander and guide oblique to their positions and halt, facing front. The guide goes to order guidon and remains at attention. The company commander faces the company. When all platoons are marking time the company commander commands **"Company, HALT;" "Order, ARMS;"** and **"Dress Right (At Close Interval, Dress Right), DRESS"** as described in paragraph 10005. After the company is dressed and the platoon commander is back in position the company commander commands, **"Ready, FRONT"** and **"COVER."**

b. On the command of **"FRONT,"** by the first company commander in line the adjutant moves by the most direct route to a position midway between the line of company commanders and the battalion commander and faces the battalion. After all units have finished dressing right, the adjutant commands **"Guides, POST."** At the command **"POST,"** the guides move to their normal positions in ranks. To do this, the guides take one step to the left, in marching, and halt at order arms.

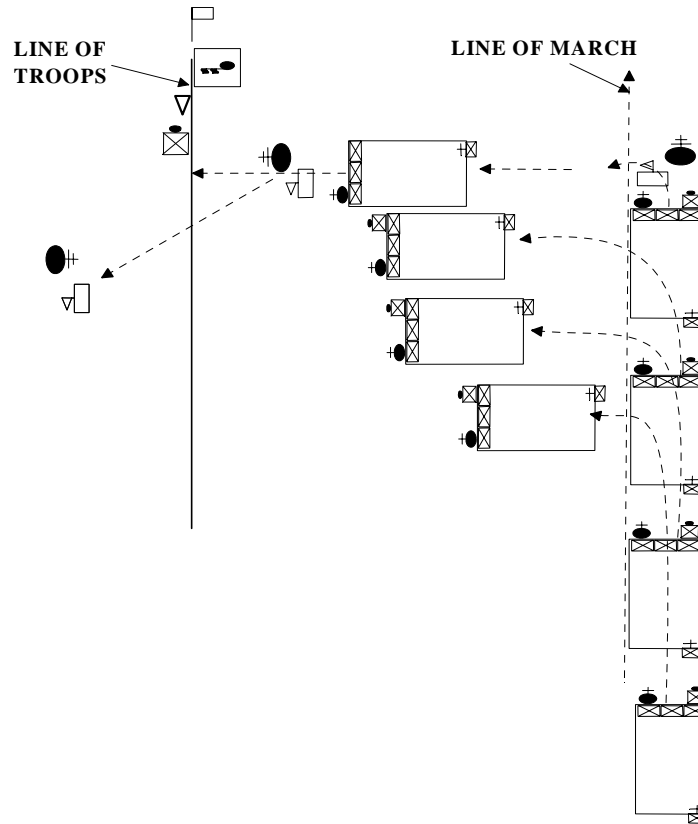

Figure 11-8.--Forming a Company Mass Left.

3. The following figure 11-9 depicts modifications to the standard formation battalion in line with companies in mass formations. The procedures and rules in paragraph 11005 apply to this modification of the standard formation.

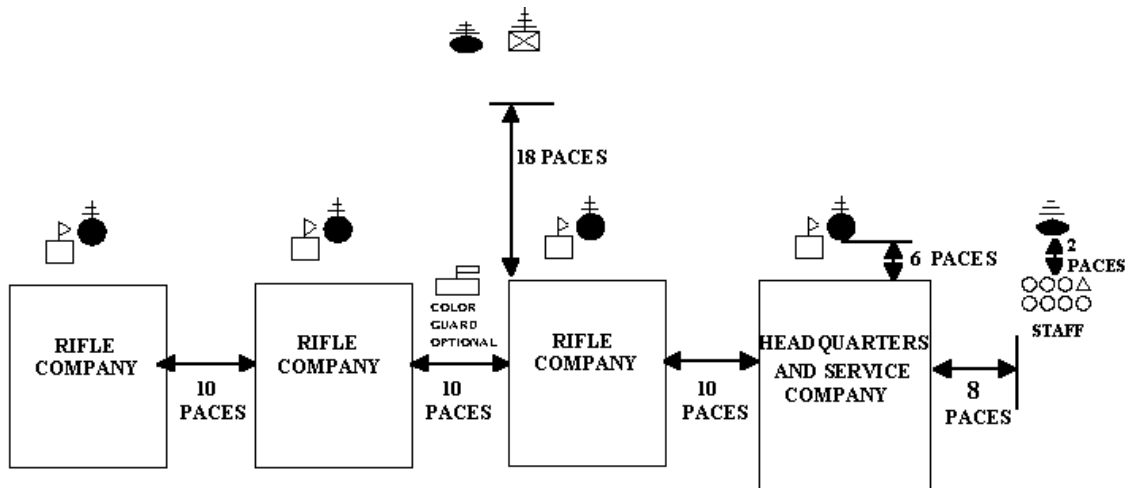

Figure 11-9.--Modified Battalion in Line with Companies in Mass Formation.

11006. TO FORM BATTALION IN MASS

1. The procedure is the same as in forming in line except that companies are marched from either flank in company mass formation at close or normal interval, the line of march being well in rear of the line on which the battalion is to form. When opposite its place in line, each company commander executes left (right) turn. As soon as the turning movement has been initiated, the company commander commands **"GUIDE OF LEADING PLATOON ON LINE."** The guide moves out at double time (at port arms), and takes his/her position on the line of troops as described in paragraph 11004.1. The company then marks time to gain cover and alignment and is halted so that there is appropriate interval (normal or close) between companies. The company is given order arms and the guide, without command, takes his/her post by taking one step to the left, in marching, and halts at order arms. The color guard, depending on the ceremony forms either 6 paces behind the staff or if the battalion is part of a regimental or larger formation is omitted. Figure 11-10 depicts the standard formation.

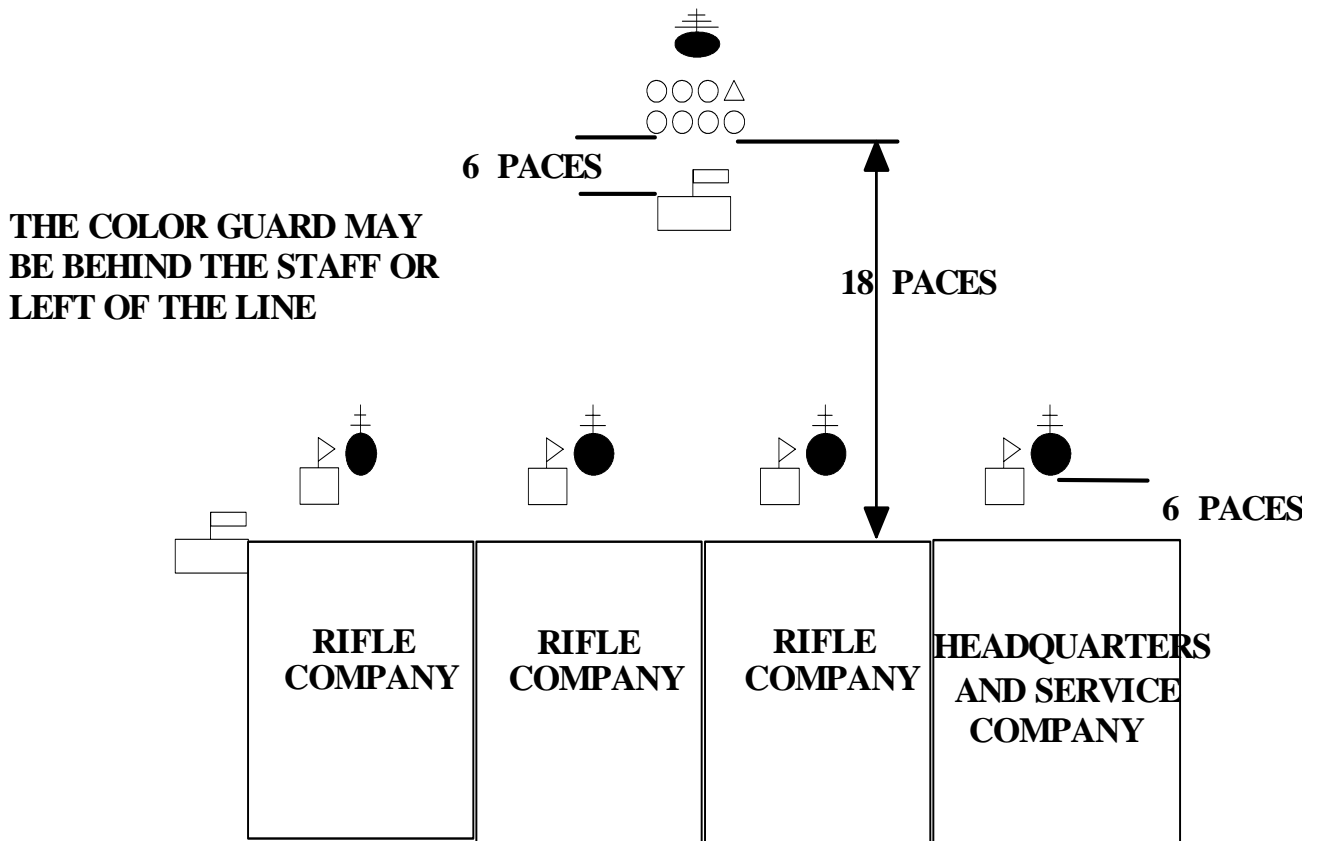

Figure 11-10.--Battalion in Mass Formation.

2. Figure 11-11 depicts the modified version of the battalion mass formation. The procedures and rules that apply in paragraph 11005 apply to this modified formation also.

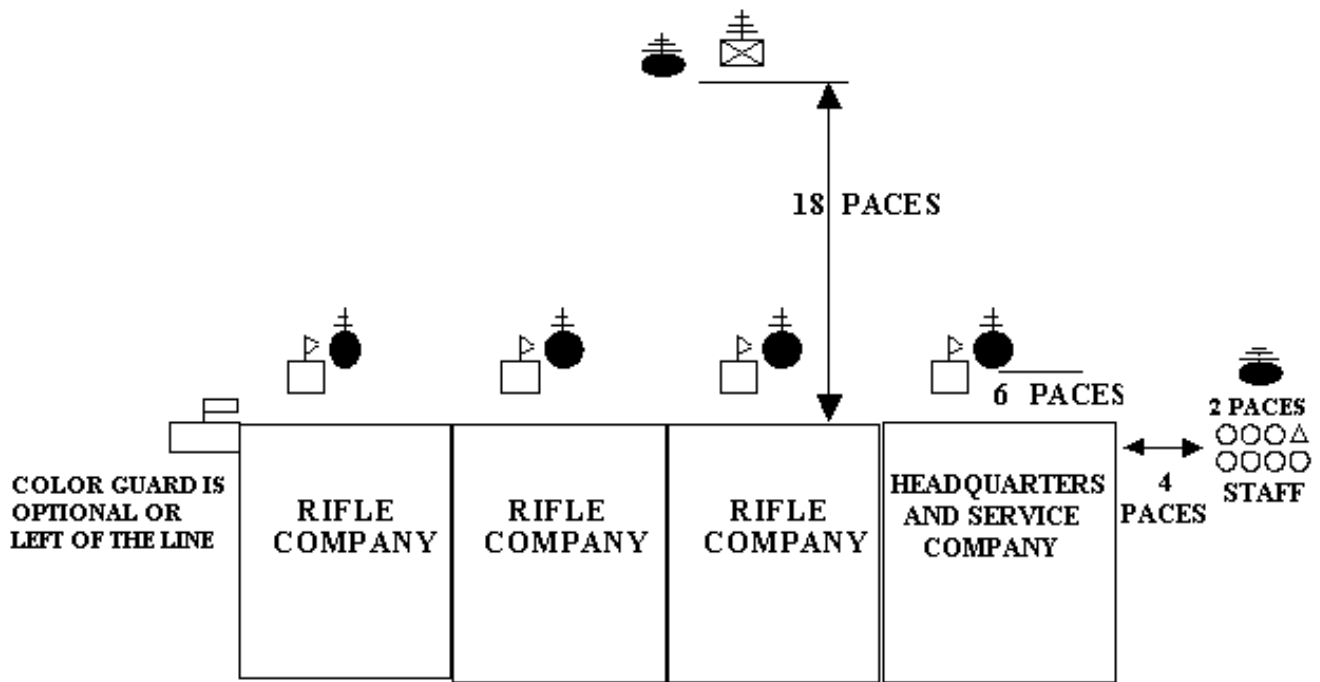

Figure 11-11.--Modified Battalion in Mass Formation.

11007. BATTALION IN COLUMN WITH COMPANIES IN COLUMN. This formation is used to move the battalion from one point to another as a whole unit. It can be used for forming in an assembly area prior to the march on during a ceremony, for battalion movement, for physical training and as the battalion commander may direct. The companies form either in mass or company column. Figure 11-12 depicts this formation.

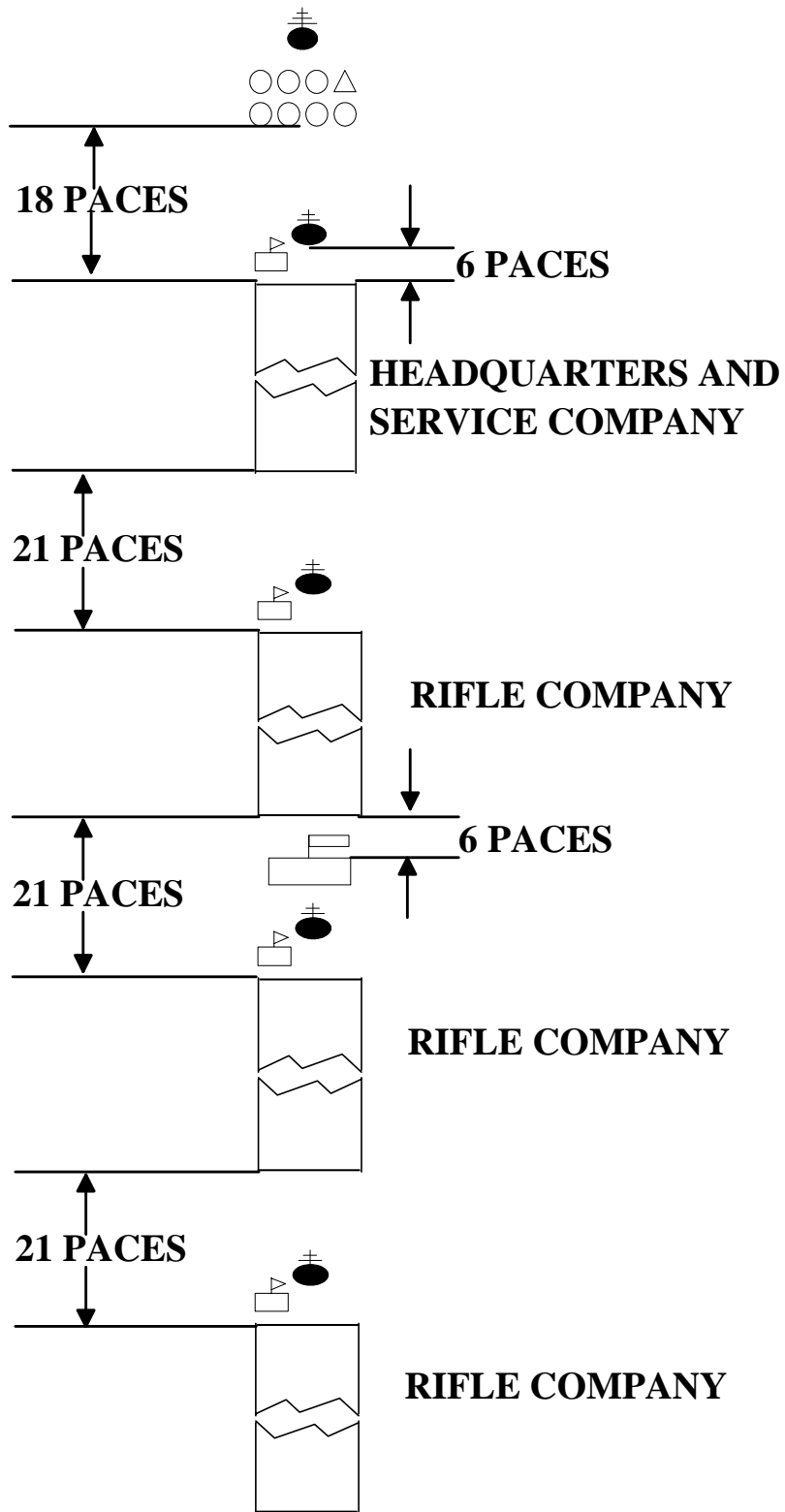

Figure 11-12.-- Battalion in Column of Companies with Companies in Line.

11008. BATTALION IN COLUMN OF COMPANIES WITH COMPANIES IN LINE. This formation is used for either a large review, ceremony or for inspecting a unit. It is formed as depicted in figure 11-13.

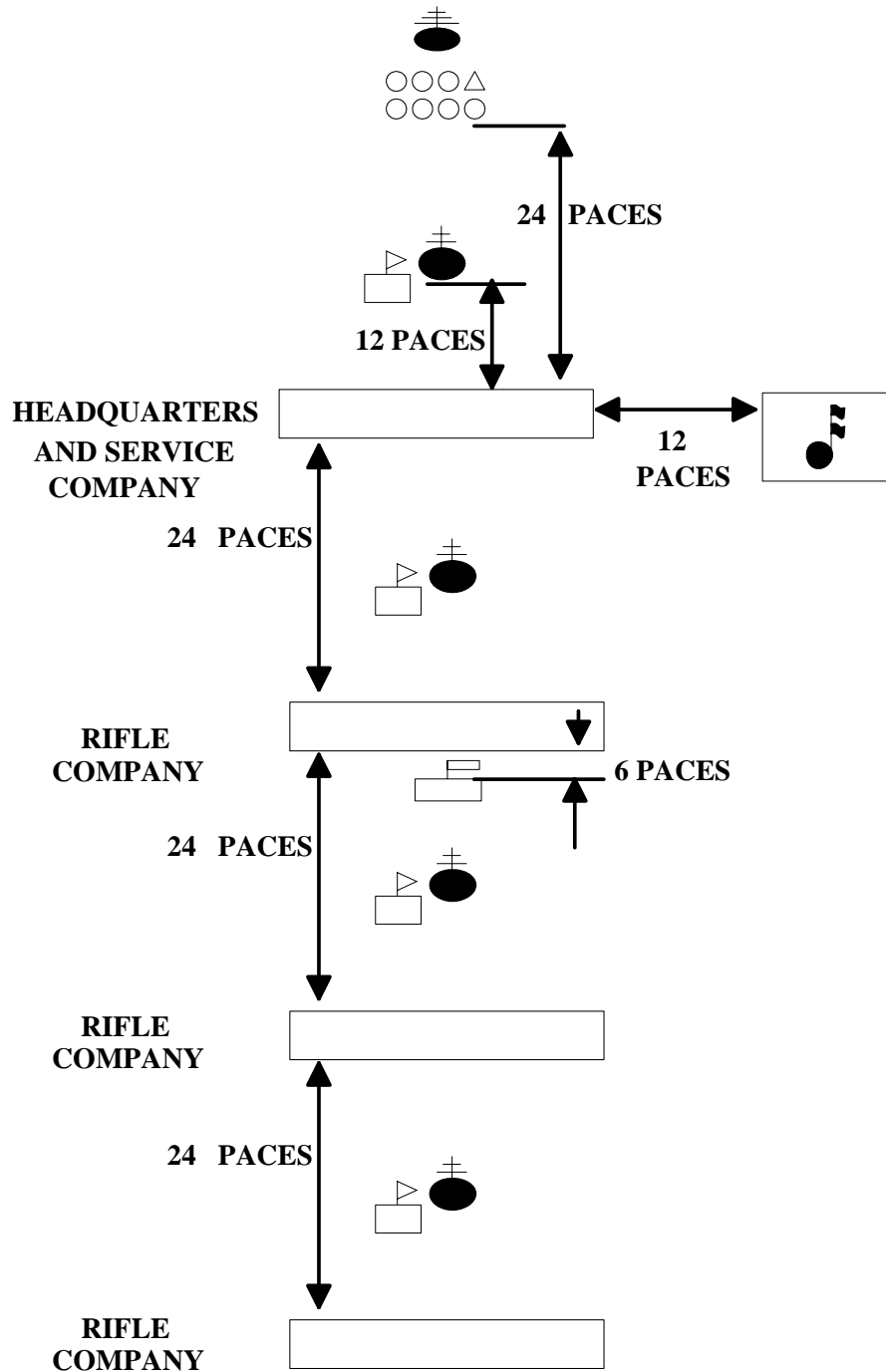

Figure 11-13.--Battalion in Column with Companies in Column.

11009. TO DISMISS THE BATTALION

1. The battalion commander commands "**DISMISS YOUR COMPANIES.**" At this command, each company commander salutes the battalion commander. He/she returns the salutes. Each company commander marches his/her company to the place for dismissal and dismisses it as prescribed in paragraph 10003. If colors were carried, the color company or color guard first returns the colors per paragraph 7304.
2. The companies having marched off, the battalion commander dismisses his/her staff. In modified formations the executive officer would take charge and dismiss the staff.
3. In case the battalion commander desires to release companies to their commanders, without prescribing that the companies promptly be dismissed, he/she commands "**TAKE CHARGE OF YOUR COMPANIES.**" Company commander's salute and the battalion commander returns the salute. The company commanders then take charge of their companies.
4. If the battalion commander turns the battalion over to the sergeant major for dismissal during modified formations then the procedures for dismissal in paragraph 10003 will be followed.

MARINE CORPS DRILL AND CEREMONIES MANUAL

PART I: DRILL

CHAPTER 12

REGIMENTAL DRILL

	<u>PARAGRAPH</u>	<u>PAGE</u>
GENERAL	12000	12-3
COMMANDS AND ORDERS	12001	12-3
FORMATIONS	12002	12-4
TO FORM THE REGIMENT	12003	12-4
TO DISMISS THE REGIMENT	12004	12-10

FIGURE

12-1	POSITION OF REGIMENTAL AND BATTALION ADJUTANTS . . .	12-5
12-2	FORMING THE REGIMENT	12-6
12-3	REGIMENT IN COLUMN WITH BATTALIONS IN COLUMN; COMPANIES IN MASS	12-7
12-4	REGIMENT IN COLUMN WITH BATTALIONS IN MASS FORMATION	12-8
12-5	REGIMENT IN LINE WITH BATTALIONS IN MASS FORMATION	12-8
12-6	REGIMENT IN LINE WITH BATTALIONS IN LINE, COMPANY MASS FORMATION	12-9

MARINE CORPS DRILL AND CEREMONIES MANUAL

PART I: DRILL

CHAPTER 12

REGIMENTAL DRILL

12000. GENERAL

1. The formations described in this Chapter pertain to the infantry regiment. Using them as a guide, other units of corresponding or larger size conform as appropriate.
2. Subordinate battalions and independent companies will assemble with the regimental color guard, staff, and commander to form the regiment.
3. Subordinate battalions will retain all members of their unit, except for their color guard, when formed with the regiment.
4. The regiment does not drill by command. Its battalions form and march as directed by the regimental commander. When practicable, the formation and movement of the subdivisions of the regiment should be made clear to subordinate commanders before starting the movement.
5. The regimental commander prescribes the formation, the uniform, individual and unit equipment, the place where the regiment is to form, the direction in which it will face, the hour of forming, location of the head of column (or right of the line), and the order in column or line of the headquarters, band, battalions, special and attached units, and trains.
6. Before the regiment is formed, the regimental commander may cause the positions that are to be taken by the larger elements to be indicated by markers.
7. Upon completing a movement ordered by the regimental commander, battalions and independent companies may be given "**REST**" until another movement is ordered. After a ceremony has started, however, units remain at attention until ordered to stand at parade rest or at ease by the regimental commander, adjutant, or commander of troops.
8. Prior to forming the regiment for any purpose, at the locations designated, each independent company forms at "Assembly" (see paragraph 1002), and each battalion forms without its colors at the first, or its own, "Adjutant's Call" (see paragraph 1103). The color guard and color battalion, after forming, receives the regimental colors (see paragraph 7302) prior to ceremonies or other prescribed occasions. All units then wait for the second or regimental "Adjutant's Call" to form the regiment.

12001. COMMANDS AND ORDERS

1. The regimental commander gives his/her commands by voice, by bugle, by signal, or in writing. They may be given directly to the officers concerned or communicated to them through his/her staff.
2. When the regimental commander, adjutant or commander of troops gives commands for drill movements to be executed by the troops, the command is given as a combined command in a voice just loud enough to be distinctly heard by

subordinate commanders so as not to cause premature execution by the troops. Subordinate battalion and independent company commanders, in succession from right to left in line, or front to rear in column, then face their command and give the necessary preparatory command and command of execution to cause the movement to be executed by their troops. For example, the regimental adjutant orders "**PRESENT ARMS**" in a manner that does not demand execution by the troops. Each subordinate commander then goes to carry sword if so armed, faces his/her command and commands "**Present, ARMS,**" the commander then faces back to the front and commands "**Staff, Present, SWORD (ARMS).**" When the adjutant commands "**ORDER ARMS,**" the subordinate commanders command "**Staff, Order, SWORD (ARMS).**" They would then face their command and command the troops to "**Order, ARMS,**" and then face back to the front and go to order sword if so armed.

3. For example, after the adjutant has presented the regiment to the regimental commander, the normal sequence of events would call for the manual of arms to be performed. The regimental commander would command "**ORDER ARMS.**" Subordinate commanders command "**Staff, Order, SWORD (ARMS).**" They would then face their command and command the troops to "**Order, ARMS.**" **The manual arms will then be executed in sequence as shown below with each battalion commander facing about after each command.**

The Regimental Commander
Commands:

Subordinate Commanders (in succession)
Command :

"PORT ARMS"

"Port, ARMS"

"RIGHT SHOULDER ARMS"

"Right Shoulder, ARMS"

"PORT ARMS"

"Port, ARMS"

"LEFT SHOULDER ARMS"

"Left Shoulder, ARMS"

"PORT ARMS"

"Port, ARMS"

"ORDER ARMS"

"Order, ARMS"

12002. FORMATIONS

1. For formations of the regiment see figures 12-2 through 12-5.

2. The color guard is posted to the left of the color battalion when the regiment is in line and to the rear of the color battalion when the regiment is in column. The color battalion is posted in the regimental formation so that the color guard is in the approximate center of the formation (right or forward of center, if exact center is impossible).

12003. TO FORM THE REGIMENT

1. To form for regimental ceremonies the procedures described for forming battalions in line in paragraphs 11004 and 11005, or battalions in mass formation in paragraph 11006 are followed, except as indicated below:

a. Prior to the start of the ceremony, the battalion adjutants take their posts behind the line of march and abreast of their position in the line of troops, draw swords if so armed, and go to parade rest. The regimental adjutant, when directed by the regimental commander or commander of troops, moves to his/her position in the line of troops, (8 paces to the right of where the right flank of the regiment will rest) faces down the line, and draws sword if so armed. The regimental adjutant then commands "**Sound, ATTENTION.**" The band plays "*Attention,*" and the battalion adjutants go to attention and carry sword.

The regimental adjutant then commands "**Sound, ADJUTANT'S CALL.**" On the first note of the music after "*Adjutant's Call*," the battalion adjutants march forward to their position in the line of troops (6 paces to the right of where the right flank of their battalions will rest), face down the line, and remain at attention and carry sword if so armed. (See figure 12-1.)

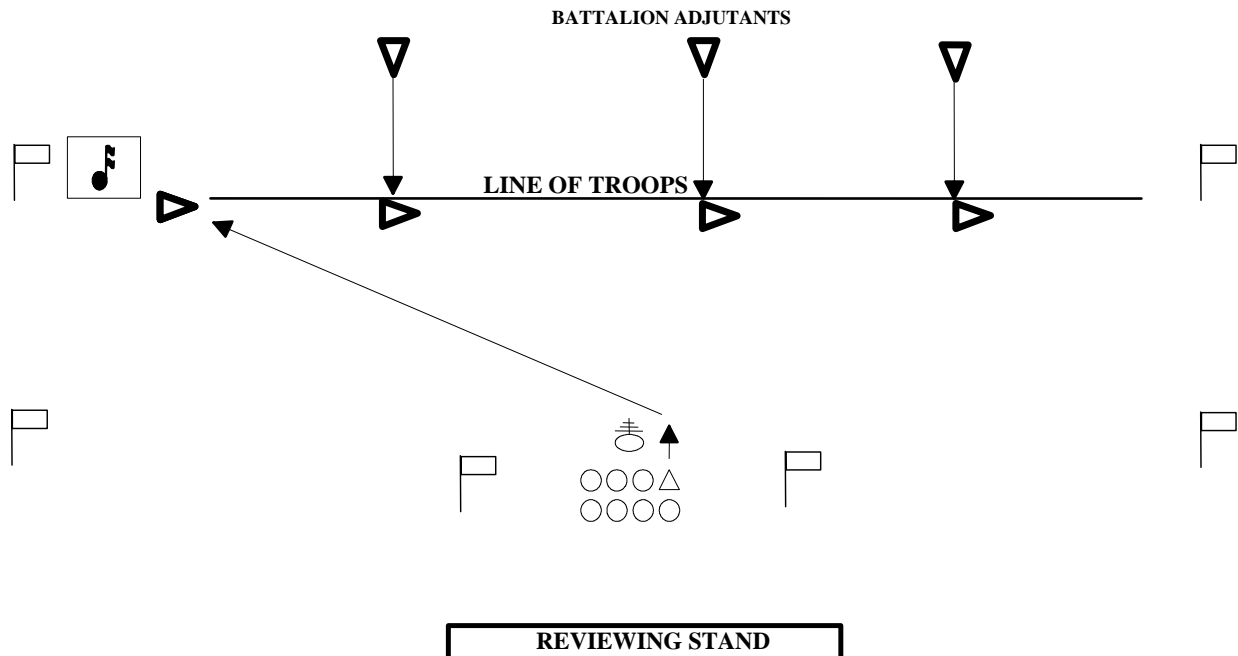

Figure 12-1.--Position of Regimental and Battalion Adjutants.

b. After the lead element of the regiment has completed dressing to the right and on the command of execution "**FRONT,**" from its commander, the regimental adjutant moves to his/her position centered on the formation and midway between the line of battalion commanders and the regimental commander, and faces the regiment remaining at attention and carry sword if so armed. After the lead element of their battalion has completed dressing to the right and on the command of execution "**FRONT,**" from its commander, the battalion adjutants return to their position in the battalion staff, and go to order sword if so armed. Once all elements of the regiment have completed dressing to the right and the battalion adjutants are back in their respective staff, the regimental adjutant commands "**Guides, POST,**" (if the units were marched on) and "**FIX BAYONETS**" (if prescribed). The ceremony would then proceed per chapters 15 through 20.

2. To form for marches, or prior to participation in a larger unit ceremony, the regiment forms at its designated location at regimental "*Adjutant's Call*" (which may be by voice command or by music) according to the same procedures set forth for a battalion in paragraph 11003, except commanders of battalions and independent companies report their arrival in the regimental formation to the regimental adjutant. Figure 12-2 depicts a regiment formed for a parade or review.

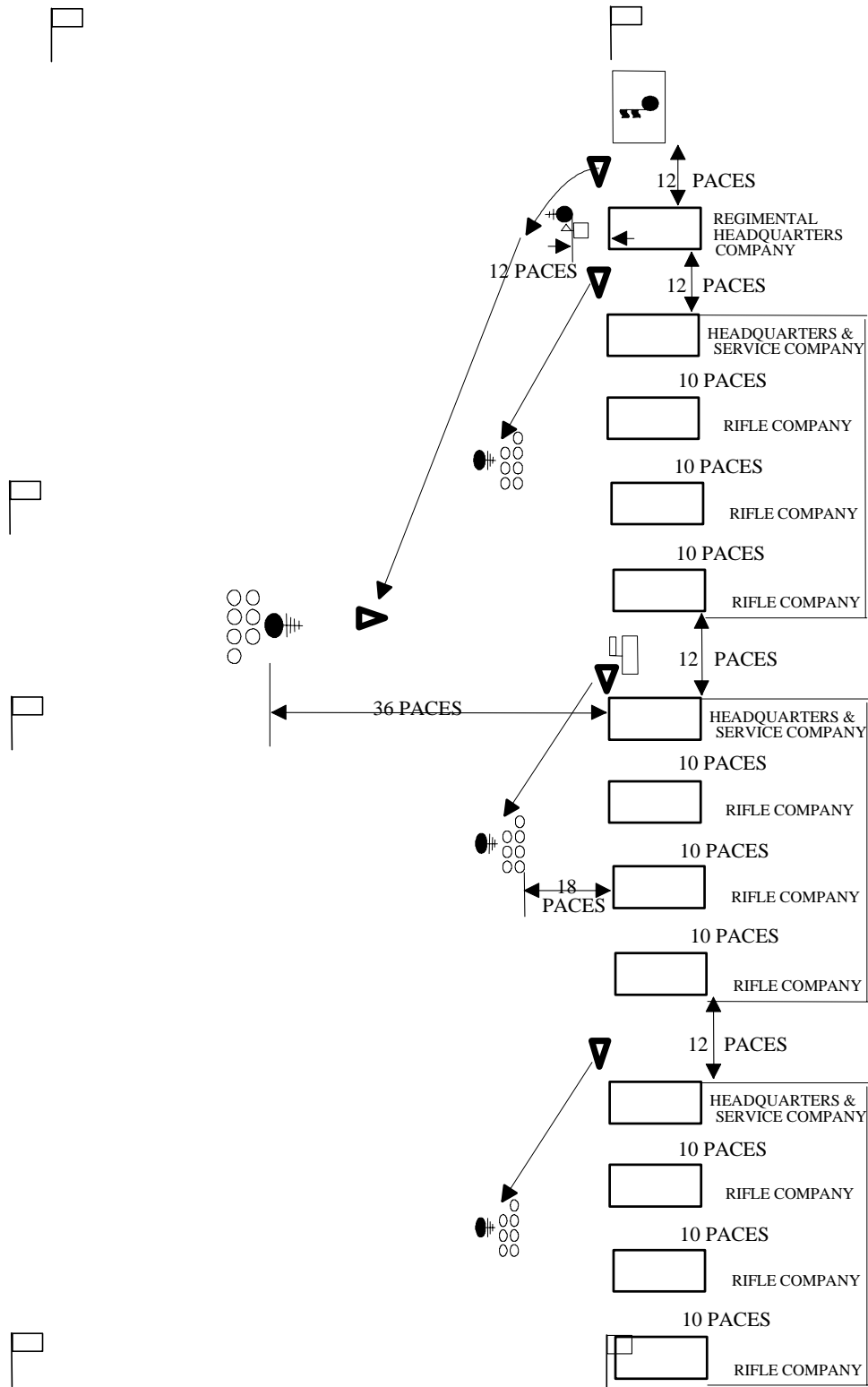

Figure 12-2.--Forming the Regiment.

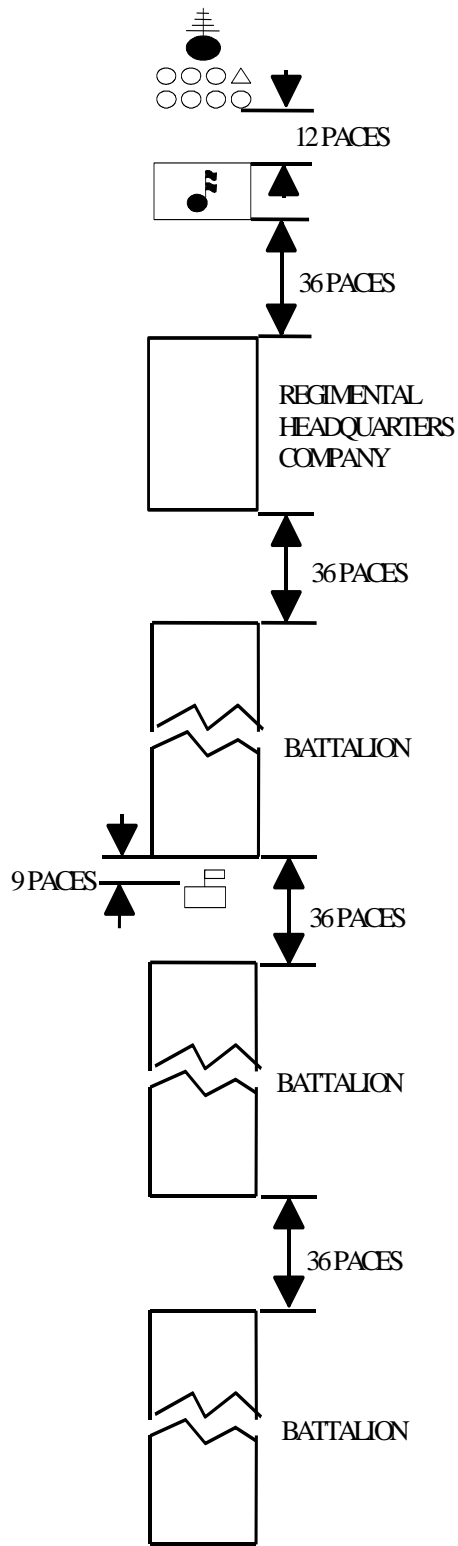

Figure 12-3.--Regiment in Column with Battalions in Column; Companies in Mass.

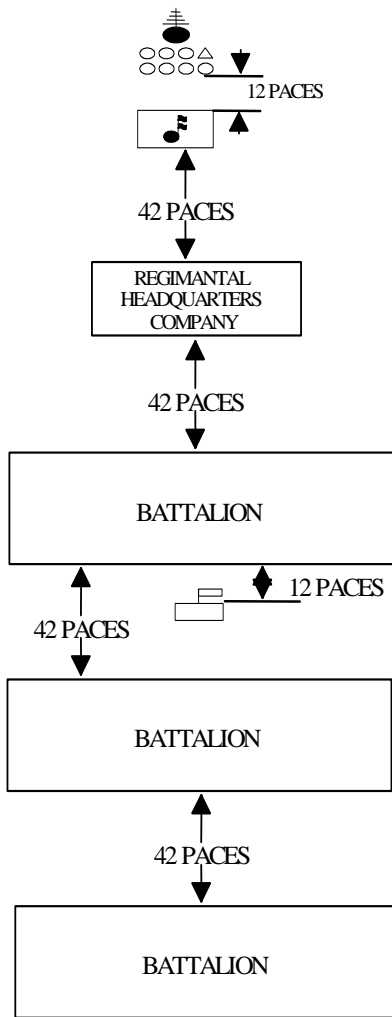

Figure 12-4.--Regiment in Column with Battalions in Mass Formation.

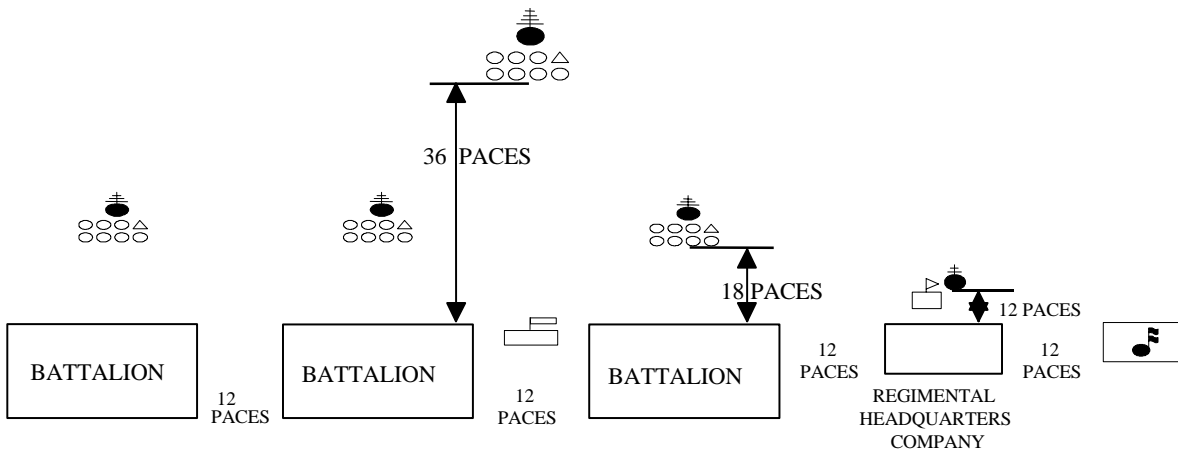

Figure 12-5.--Regiment in Line with Battalions in Mass Formation.

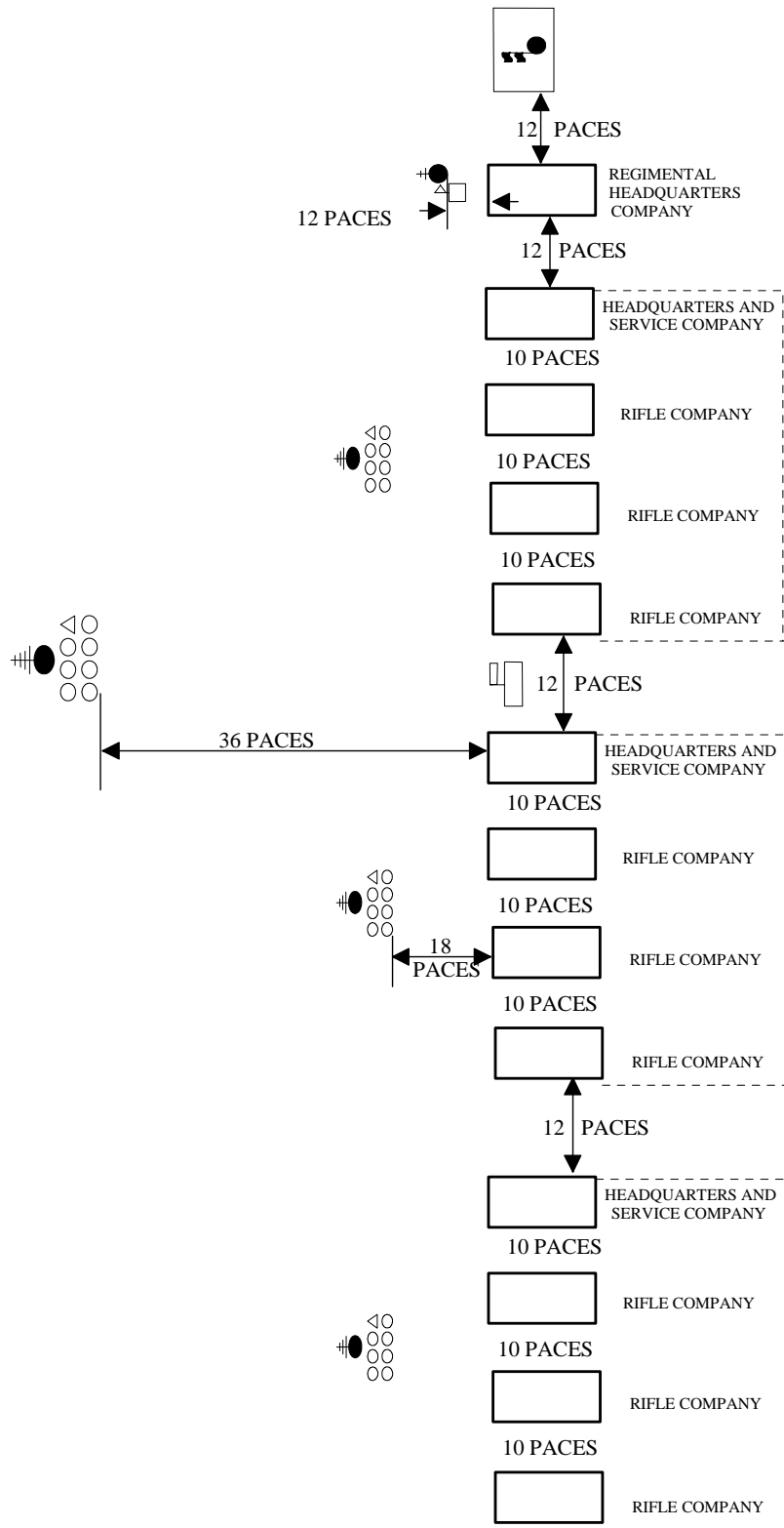

Figure 12-6.--Regiment in Line with Battalions in Line, Company Mass Formation.

12004. TO DISMISS THE REGIMENT. To dismiss the regiment, the regimental commander orders the battalion, and independent company commanders to dismiss their commands.

MARINE CORPS DRILL AND CEREMONIES MANUAL

PART I: DRILL

CHAPTER 13

INSPECTIONS

	<u>PARAGRAPH</u>	<u>PAGE</u>
GENERAL	13000	13-3
COMPANY FORMATIONS	13001	13-3
INSPECTION OF PERSONAL FIELD EQUIPMENT IN RANKS	13002	13-4
INSPECTING OFFICER OTHER THAN COMPANY COMMANDER	13003	13-6
BATTALION INSPECTIONS	13004	13-6
REGIMENTAL INSPECTION	13005	13-7
INSPECTION OF QUARTERS OR CAMP	13006	13-7

FIGURE

13-1	COMPANY FORMED FOR INSPECTION, COMPANY IN LINE	13-8
13-2	COMPANY FORMED FOR INSPECTION, COMPANY COLUMN OF PLATOONS IN LINE	13-9
13-3	INSPECTION OF PERSONAL FIELD EQUIPMENT IN RANKS	13-10
13-3a	INSPECTION OF PERSONAL FIELD EQUIPMENT IN RANKS, PLATOON SPACING	13-11

MARINE CORPS DRILL AND CEREMONIES MANUAL

PART I: DRILL

CHAPTER 13

INSPECTIONS

13000. GENERAL. The company is the basic unit for inspection. Battalion, regimental, and higher commanders or inspecting officers inspect each company in its own area, or have it march to a specified place at a designated time for inspection. Under special conditions, an entire battalion or regiment may be inspected in one large formation.

13001. COMPANY FORMATIONS

1. General. The company forms in line or in column of platoons in line as prescribed in chapter 10. If transportation is included, it forms 12 paces in rear of the troops. Drivers remain with their vehicles. (See figure 13-1.)

2. Procedure

a. When ready to inspect, the company commander commands "**PREPARE FOR INSPECTION.**" At this command, the platoon commanders open ranks by platoons. The right platoon executes the initial movement. The second platoon, as described in paragraph 9016, opens ranks when the front rank of the first platoon has been aligned. The third and subsequent platoons do not begin to open ranks until the front squad of the platoon to its right has been aligned. All platoon commanders align their squads on the corresponding squad of the platoon to their right. (See figure 13-1.) When the formation is a column of platoons in line, platoon commanders open ranks successively from front to rear without awaiting the alignment of the platoon to their front. They cause their units to cover the corresponding files to their front. (See figure 13-2.) In opening ranks and aligning their platoons, platoon commanders comply with the procedures prescribed for platoon drill. After verifying the alignment of the rear rank, each platoon commander faces to the right in marching, moves 3 paces beyond the front rank, faces the left, and commands "**Ready, FRONT**" and "**COVER.**" After giving the command "**COVER,**" each platoon commander takes one step forward and faces to the front, thereby being in a position 3 paces in front of the right file of the front rank of their respective platoon. It is at this post that the platoon commander receives the inspecting officer.

b. When all ranks have been opened, the company commander commands "**AT EASE.**" He/she then inspects the company. During the inspection, officers, staff noncommissioned officers, and guidon bearers, not in ranks, come to attention at order arms as the company commander approaches. After being inspected, they resume at ease. The company commander may direct the first sergeant to accompany him/her for the purpose of taking notes. The inspection begins at the head of the column or the right of the line. The company commander inspects the arms, equipment, dress, and appearance of the personnel. As he/she approaches each platoon, its commander brings his/her unit to attention and salutes. After being personally inspected, the platoon commander returns sword (if so armed) and places himself/herself on the right of the company commander. He/she precedes the company commander during the entire inspection, down the front and rear of each squad. The company commander may direct that squads having been or not yet inspected be given at ease while he/she inspects others. In this case, the platoon commander complies and brings them to attention for inspection at the proper time.

c. The inspection is made from right to left in the front and from left to right in the rear of each rank. After inspecting the platoon commander, the company commander moves around the platoon commander's left to a position in front of the right flank Marine in the first rank. He/she moves from Marine to Marine by stepping off to the right in marching, taking one and one half steps, halting, and executing a left face. The platoon commander must move in the same manner so as not to be in the company commander's way.

d. Each Marine executes the movements to inspection arms for his/her weapon immediately after the company commander has completed the left face movement and is facing him/her.

e. The company commander takes all individual weapons from the individual being inspected. He/she takes the rifle by grasping the handguard with his/her right hand. The Marine whose rifle is being inspected immediately drops his/her hands to the sides. After inspecting the weapon, the company commander hands it back with his/her right hand in the same position. The Marine smartly takes his/her weapon by grasping the center of the handguard just forward of the slipring with his/her left hand, closes the bolt, pulls the trigger, and returns the weapon to order arms as soon as he/she receives it. The company commander takes and returns other weapons in the most convenient manner. A detailed inspection will include bayonets and other equipment carried.

f. Bayonets will be inspected when the company commander is in the rear of the rank. He/she will take and replace them without assistance from the Marine being inspected. The Marine will merely raise his/her left arm when the company commander takes and replaces the bayonet.

g. Upon completion of the inspection of his/her platoon, the platoon commander, having led the company commander down the rear of the last squad, executes column left and halts when 3 paces beyond the right flank member of the first rank. He/she faces left, calls the entire platoon to attention, and then resumes his/her post, (see paragraph 13001.2a) the company commander passes to his/her right, faces to the left in marching, halts, and executes a left face. He/she then gives the platoon commander any instructions necessary. The platoon and company commanders exchange salutes and the latter proceeds to the next platoon.

h. Upon completion of the inspection of each platoon, its commander faces to the left and orders "**Close Ranks, MARCH.**" At the command "**MARCH,**" the platoon commander moves by the most direct route and takes his/her post 6 paces in front of and centered on his/her platoon.

i. The company commander may direct the platoon commanders to make the detailed inspection by ordering "**Platoon Commanders, INSPECT YOUR PLATOONS.**" In this case, each platoon commander complies. They may direct their platoon sergeants to accompany them for the purpose of taking notes. The company commander will normally spot check individuals while platoon commanders are inspecting their platoons. In this case, Marines at ease will automatically come to attention upon the company commander's approach, and to inspection arms if the company commander stops in front of them, regardless of whether they have been previously inspected.

13002. INSPECTION OF PERSONAL FIELD EQUIPMENT IN RANKS

1. The company forms in company column of platoons in line at open ranks, for a preliminary rifle inspection. After the inspection of the first platoon, the

company commander directs the platoon commander to prepare for inspection of equipment. Upon the company commander's departure to inspect the arms of the next platoon, the platoon commander orders, "**First Squad, 2 Paces Forward, MARCH;**" "**Second Squad, 1 Pace Forward, MARCH;**" and "**Fourth Squad, 2 Paces Backward, MARCH.**" (See figures 13-3 and 13-4.) The platoon commander then causes the platoon to take interval to the left, after which the Marine commands "**UNSLING EQUIPMENT.**" Upon the completion of this, the Marine orders "**DISPLAY EQUIPMENT.**"

2. At the command "**UNSLING EQUIPMENT,**" each Marine draws their bayonet and thrusts it into the ground, with their left hand, outside and against the left instep. The bayonet ring is to the front. Marines not armed with the bayonet mark the place with their left heels. This is to mark the rear right corner of the individual's equipment layout. Each member armed with a shoulder weapon lays it on the ground with muzzle to the front, barrel to the left, and butt near the toe of their right foot. The Marines then unslings their equipment and places it on the ground 1 foot in front of their feet. The top of the pack should be to the front and the side that faces rear when worn should be up. All Marines resume attention when finished.

3. At the command "**DISPLAY EQUIPMENT,**" packs are opened and equipment displayed as in current directives. The equipment is displayed in the interval to the left of each Marine. As Marines finishes arranging their equipment, each Marine resumes attention in their original position in ranks.

4. The company commander returns to the first platoon after inspecting the arms of the last. The company commander passes along the ranks from right to left as before. When, finished inspecting the platoon, the Marine directs the platoon commander to have the packs rolled and proceeds to the platoon commander of the next platoon to be inspected. The post and his/her action of the platoon commander during the company commander's arrival and departure is the same as described in paragraph 13001.2.

5. The platoon commander then commands "**ROLL PACKS.**" Each Marine assembles their equipment and rolls their pack. The member places it in front of themselves, as described in paragraph 13002.2 and comes to attention.

6. After all equipment is assembled and packs are rolled, the platoon commander commands "**SLING EQUIPMENT.**" All Marines sling packs, fasten belts, and take arms. They then assume their original place in formation, at attention and order arms.

7. The platoon commander then causes the platoon to close interval and then close ranks, after which the Marine gives "**REST**" or "**AT EASE.**"

8. In units such as weapons or headquarters and service companies, which have special combat equipment, the company commander, after packs have been opened, or after individual inspection, directs "**DISPLAY MACHINE-GUN, MORTAR, or other EQUIPMENT.**" Gun teams/squads under the direction of their leaders break ranks and lay out their weapons and accessories for inspection as described in the gun drill for that particular weapon. Headquarters personnel lay out their fire control, communication, or other equipment in a similar manner. Such equipment will be displayed 3 paces from the right of the squad's flank. The rear of the equipment is placed on line with the rear of the individual field equipment.

13003. INSPECTING OFFICER OTHER THAN COMPANY COMMANDER. Should the inspecting officer be other than the company commander, the latter will face the original front of Marine's company after commanding "**AT EASE.**" Upon the approach of the inspecting officer, the inspection proceeds as previously explained. The company commander follows the inspecting officer.

13004. BATTALION INSPECTIONS

1. The battalion is formed in column of companies with companies in line or battalion in line with companies in line, as prescribed in chapter 11. Before the inspection, the battalion commander indicates whether crew-served weapons and special equipment are to be displayed. They may be laid out at the armory or left on their transportation for subsequent inspection.
2. When the companies are in position, the battalion commander commands "**PREPARE FOR INSPECTION.**" At this command, all companies prepare as described in paragraph 13001. The color guard proceeds to a position 3 paces to the rear of the battalion staff.
3. The battalion commander then commands "**REST,**" returns sword if so armed, and inspects battalion staff and color guard. The staff members come to attention without command, upon the battalion commander's approach, and execute order sword. When the battalion commander approaches the color guard, after inspecting the staff, the staff members return sword and accompanies the battalion commander. The senior color bearer brings the color guard to attention. The battalion commander may dismiss the color guard as soon as inspected.
4. The battalion commander, beginning at the right of the line or at the head of the column, inspects the arms, equipment, dress, and appearance of the personnel in each company.
5. As the battalion commander approaches each company, its commander calls it to attention, faces the front, and salutes. As soon as the company commander has been inspected, the company commander gives the unit "**REST,**" returns sword if so armed, and accompanies the battalion commander during the inspection. The inspection proceeds as described in paragraph 13001.
6. The battalion commander may direct the company commanders to make the detailed inspections of their own companies, in which case the battalion commander will usually spot check individuals throughout the battalion. In such a case, all Marines react as described in paragraph 13001.2 upon the approach of the battalion commander. The battalion commander may also direct members of the battalion staff to inspect individual companies, in which case company commanders react as described in paragraph 13001.
7. After a company has been inspected, unless otherwise directed it may be marched from the field and dismissed.
8. When desired, the battalion commander may direct companies not being inspected to stack arms, fall out, and wait their turn in the immediate vicinity. In this case, company commanders so instructed must fall their Marines in and prepare for inspection in time so as not to delay the entire inspection.

2. If the inspecting officer is other than the battalion commander, the latter prepares the battalion for inspection in the same manner. Upon the approach of the inspecting officer, the battalion commander brings the battalion to attention, faces the front, and salutes. After being personally inspected, the commander gives the battalion "REST," returns sword if so armed, and accompanies the inspecting officer. The inspecting officer proceeds as previously prescribed for the battalion commander.

13005. REGIMENTAL INSPECTION. Only in an exceptional situation will an entire regiment be inspected in one formation. However, when held, the principles are the same as for the battalion. The regiment may be formed in any manner suitable to the available space and ground. Battalions are prepared for inspection as described in paragraph 13004. Upon the approach of the inspecting officer, each battalion commander brings their unit to attention and salutes. Battalion inspections then follow.

13006. INSPECTION OF QUARTERS OR CAMP

1. General. In quarters, the Marines stand near their respective bunks uncovered and without equipment or arms. In camp or bivouac, they stand outside their tents covered but without equipment or arms. If the inspection of individual equipment and/or clothing has been ordered, each Marine arranges the required articles as described in current directives.
- 2. Battalion. During the inspection of the quarters or camp of a company, the battalion commander is accompanied by the company commander and preceded by the first sergeant and a bugler. The first sergeant causes the bugler to sound "*Attention*" as the inspecting party approaches. In the absence of a bugler, the first sergeant uses the voice command. Such other officers as may be designated accompany the battalion commander on the inspection.
 3. Regimental. The procedure is the same as outlined in paragraph 13006.2 above. The regimental commander is accompanied by the battalion commander and commander of the company being inspected.

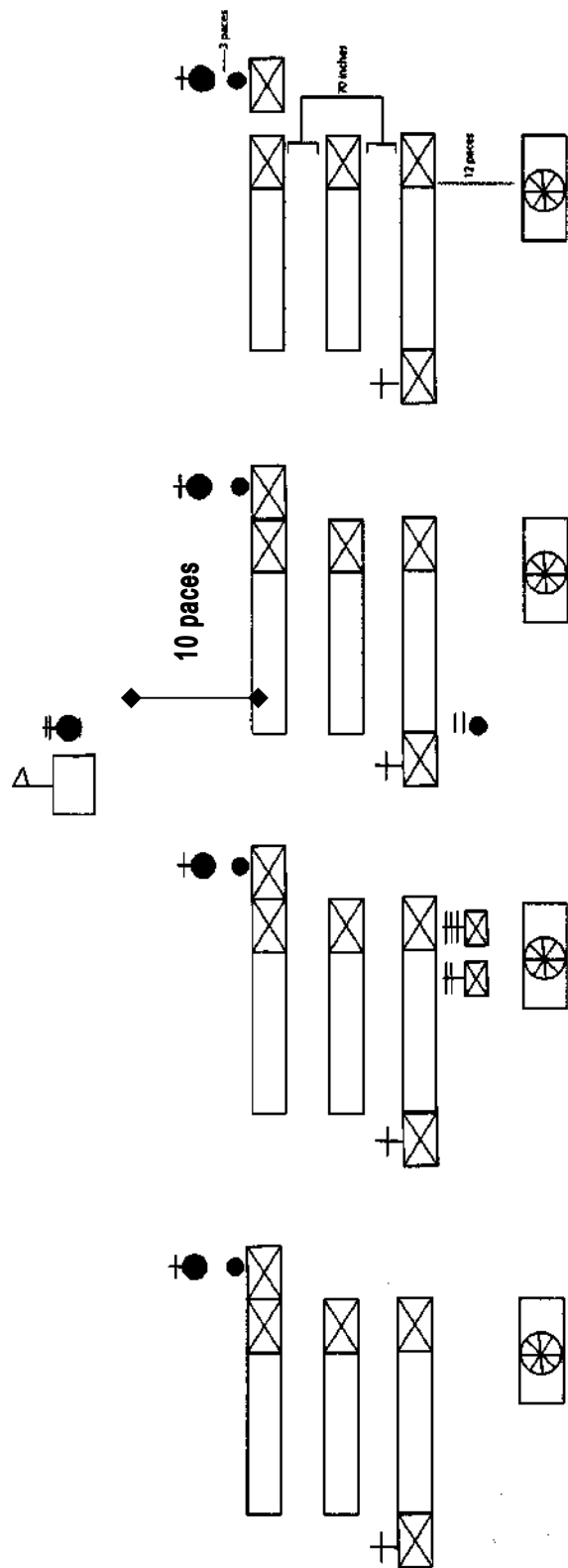

Figure 13-1.--Company Formed for Inspection, Company in Line.

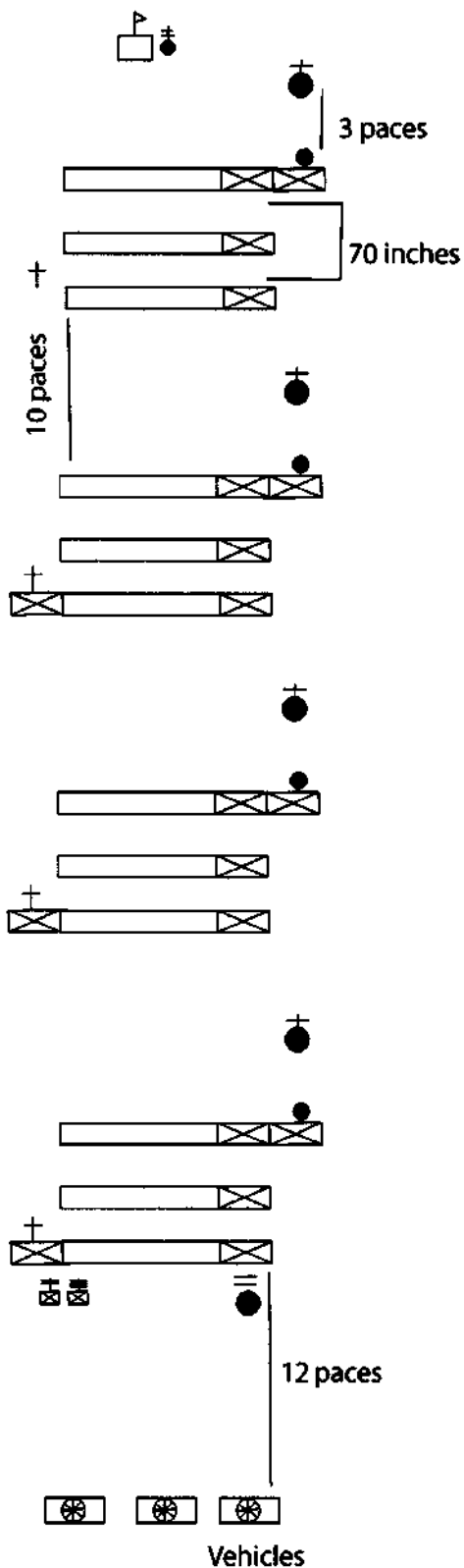

Figure 13-2.--Company Formed for Inspection, Company Column of Platoons in Line.

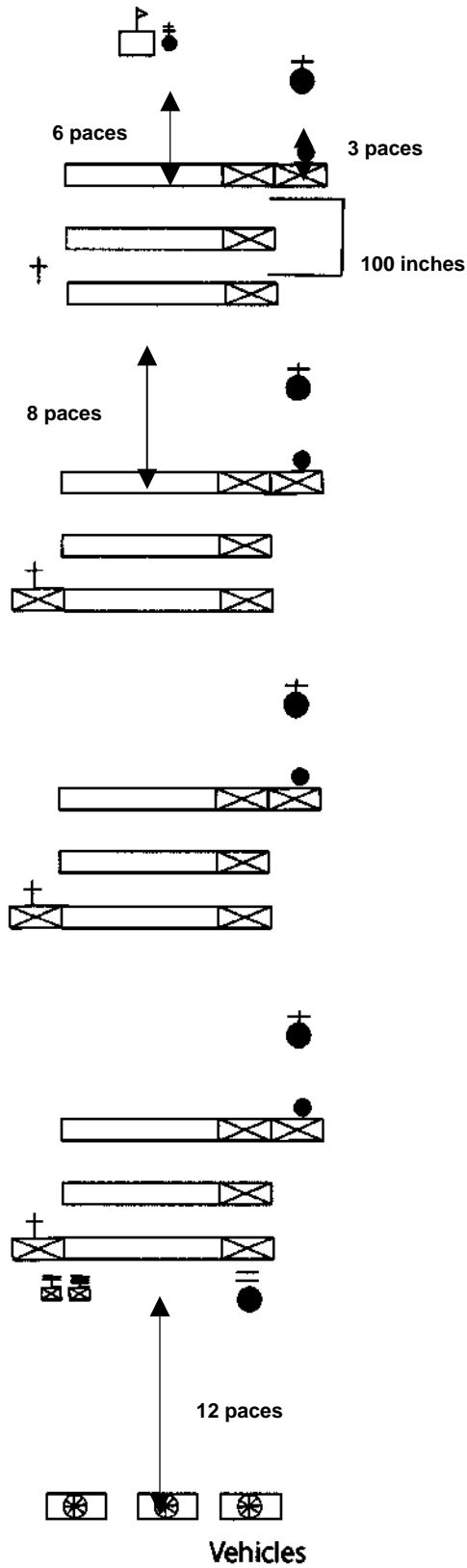

Figure 13-3.--Inspection of Personal Field Equipment in Ranks.

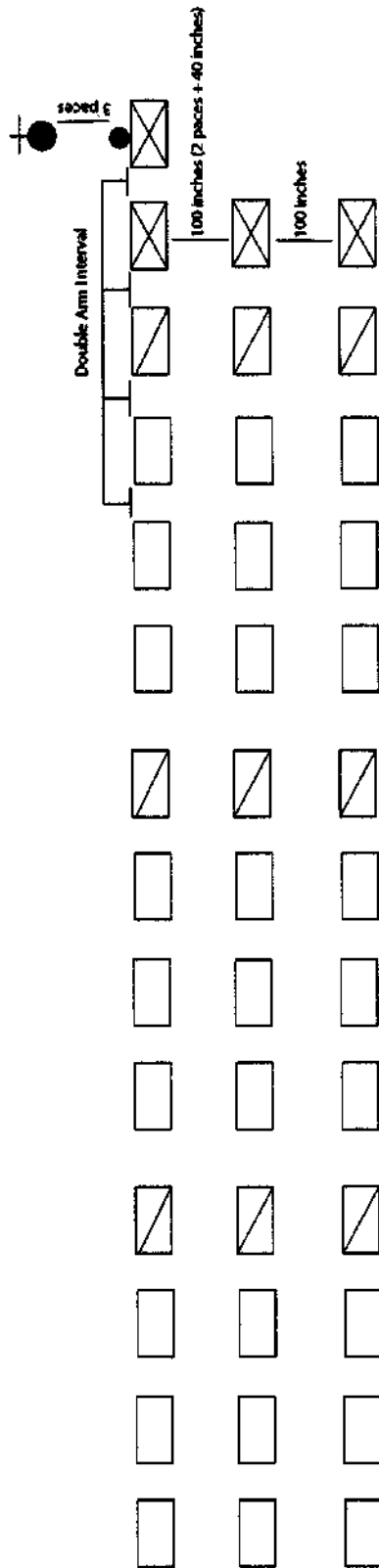

Figure 13-3a.--Inspection of Personal Field Equipment in Ranks, Platoon Spacing.

MARINE CORPS DRILL AND CEREMONIES MANUAL

PART I: DRILL

CHAPTER 14

ORGANIZATIONAL AND PARADE STAFF

	<u>PARAGRAPH</u>	<u>PAGE</u>
GENERAL	14000	14-3
FORMING THE STAFF	14001	14-3
STAFF SALUTES	14002	14-5
MOVEMENTS OF THE STAFF	14003	14-5
DISMISSING THE STAFF	14004	14-12

FIGURE

14-1	THE STAFF	14-3
14-2	STAFF FALL IN.	14-4
14-3	MARCH ON THE STAFF	14-4
14-4	TURNING MOVEMENTS	14-6
14-5	BOXING THE STAFF	14-7
14-6	MOVEMENTS OF THE STAFF WHEN COLORS ARE BROUGHT FORWARD	14-9
14-7	MOVEMENTS OF THE STAFF FOR POSTING THE COLORS . . .	14-10
14-8	MARCHING IN REVIEW	14-11

PART I: DRILL

CHAPTER 14

ORGANIZATIONAL AND PARADE STAFF

14000. GENERAL

1. The staff officers of a commander form 2 paces to the commander's rear in one rank, at normal interval. Enlisted personnel form 2 paces to the rear of the commissioned officers in one rank, at normal interval. If only one staff officer is present, the Marine he is posted 1 pace to the right and 2 paces to the rear of the commander. Staff officers are arranged with the adjutant on the right and the S-2, S-3 and S-4 to the left in that order, but the commander may arrange them in any order. Enlisted personnel forming with the staff ordinarily are posted by seniority of grade from right to left. (See figure 14-1.) When enlisted personnel, e.g., a staff noncommissioned officers or noncommissioned officers, conduct a parade or ceremony the staff will consist only of enlisted.

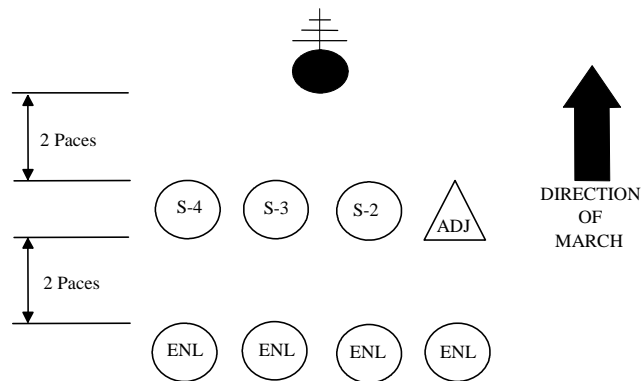

Figure 14-1.--The Staff.

- 2. All commands for the staff is preceded by the word **"Staff"** (e.g., **"Staff, Draw, SWORD"** and **"Staff, Eyes, RIGHT"**). Commands for the staff are given only loudly enough for the staff to hear in order to prevent the formation from prematurely executing a command. When giving sword commands to the staff, the commander of troops will always be at the same sword position as the staff and execute with them.

14001. FORMING THE STAFF

- 3. Prior to forming, the staff may be positioned together on either side of the reviewing area or spilt on opposite sides, depending on the layout of the reviewing area/parade field and the commander's desires. To form the staff for a parade or other ceremony, the commander moves to a position in front of the reviewing stand and centered between the dress guidons, halts facing the reviewing stand and command **"Staff, FALL IN."** The members of the staff move from their positions and form in front of, centered on and facing the commander. When the staff falls in they do not raise their arms nor turn their heads and eyes to the right for alignment. Once the staff is in position the commander does an about face and faces the line of troops. (See figure 14-2.)

Enclosure (1)

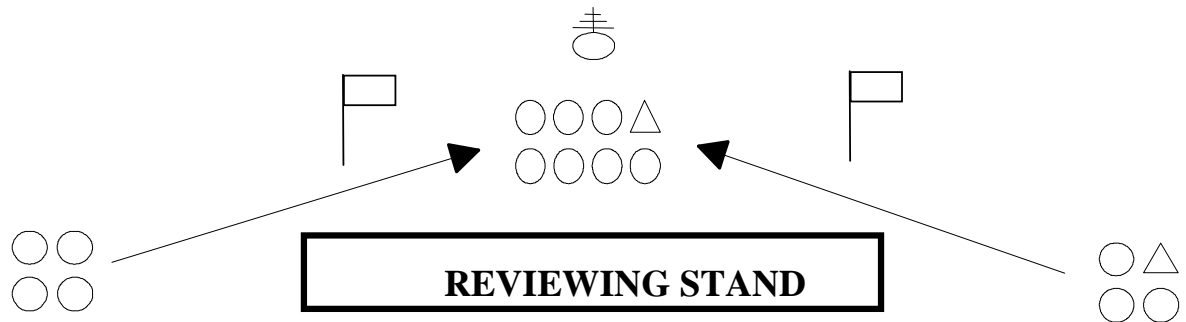

Figure 14-2.--Staff Fall In.

2. The staff, on the first note of the music following "*Adjutant's Call*," march forward on command of the commander of troops from their position in front of the reviewing area to a post midway between the reviewing area and the line of troops and halt facing the line of troops. (See figure 14-3.) If armed with swords they remain in the scabbards.

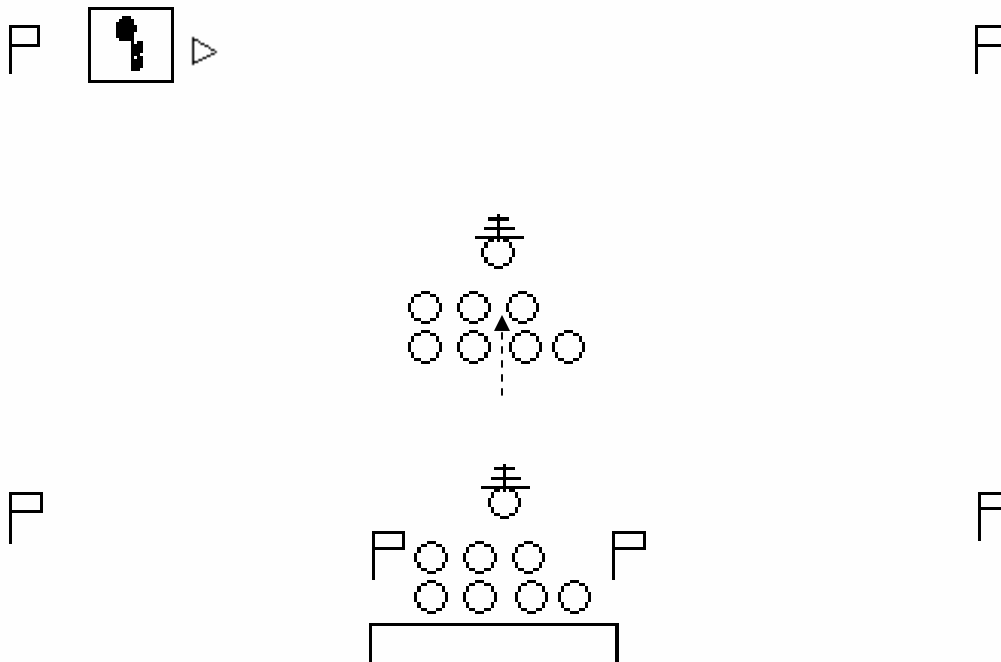

Figure 14-3.--March on the Staff.

- 3. The staff draws sword on the command of the commander. For the senior staff of a formation or parade this is done after the adjutant has formed the parade, reported to the commander and taken his/her post in the staff. The commander then commands "**Staff, Draw, SWORD**" and "**Staff, Order, SWORD.**" The commander remains at the carry. The staffs of subordinate commanders draw swords prior to marching the unit onto the field. The staff(s) remains at order sword except when:

Enclosure (1)

- a. Boxing the Staff.
- b. Moving to clear a path for the colors to be brought forward.
- c. When at present, parade rest, at ease or rest.
- d. Passing in review or any other marching or facing movements that require the staff to move.
- e. The staff, including the staffs of subordinate commanders, remains at the order during the manual of arms.

4. During regimental/group parades, at officers center all battalion/squadron commanders and their staff's close center on the original line of battalion/squadron commanders. Additionally, during division/wing parades the regimental/group commanders and their staffs, in addition to the battalion/squadron commanders and their staffs, close center on the original line of regimental/group commanders.

14002. STAFF SALUTES. Members of the staff salute with the commander, on the commander's separate command to the staff at the following times:

1. When passing in review.
2. When rendering honors.
3. When passing the national colors or the national colors pass to its front.
- 4. While the "National Anthem," "To The Color" "Hail to the Chief," "Taps," (when played for memorials) and other musical salutes that require a salute is played. Salutes are also rendered when "Retreat" is played during reviews and all ceremonies, except at evening parade. At evening parade, "Retreat" is played immediately after "Sound Off" while the troops are at parade rest, and is therefore not saluted. In this case, after "Retreat," troops are brought to attention and salutes are rendered while the "National Anthem" is played to lower the national ensign.
5. At any other time the troops are brought to present arms.

14003. MOVEMENTS OF THE STAFF

1. The staff marches 2 paces to the rear of the commander in two ranks. The staff changes direction by making turning movements vice column movements. The staff only marches in column when boxing the staff and when moving to the side in order to allow the color guard to march forward. The staff aligns to the right, except when making a turn, when the alignment shifts to the direction of the turn.
2. When the battalion commander faces to the right (left) and marches off, the staff follows by making a turning movement. The command is "**Staff, Right (Left) Turn, MARCH.**" (See figure 14-4.)

Enclosure (1)

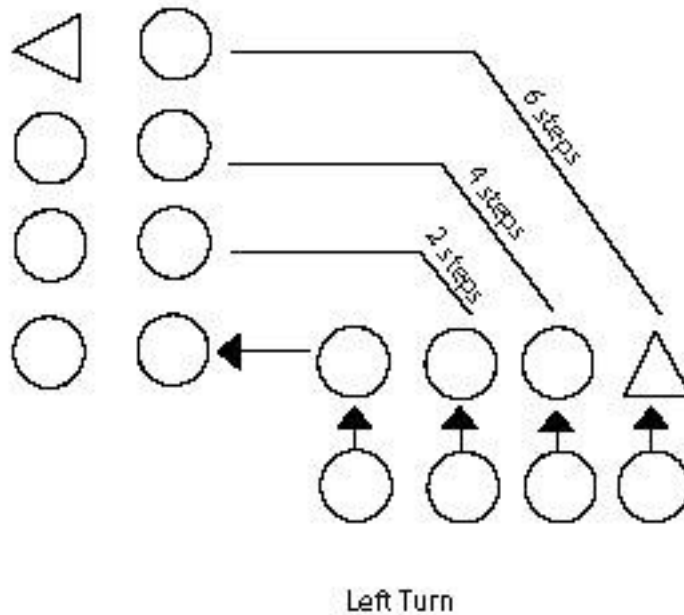
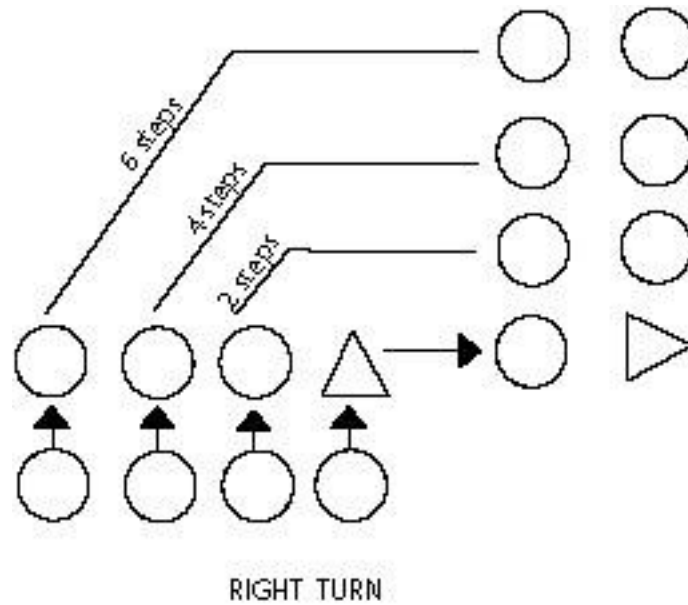

Figure 14-4.--Turning Movements.

3. During parades and other ceremonies when it is prescribed for the staff to change its position in order to place itself in the rear of the battalion commander (who has faced about, as when the battalion commander has formed the battalion and now faces the reviewing officer) the commander will order the adjutant (or senior staff officer) to **"BOX THE STAFF."** The adjutant would then give the following commands to the staff in order to place them to the rear of the commander. (See figure 14-5.)

- a. **"Staff, Carry, SWORD"** (if armed with swords).
- b. **"Staff, Left, FACE."**
- c. **"Staff, Column Right, MARCH."** (Second column right is executed without command. Once each staff member has reached their new position they automatically mark time.)
- d. **"Staff, HALT."**
- e. **"Staff, Right, FACE."**
- f. **"Staff, Order, SWORD"** (if armed with swords).

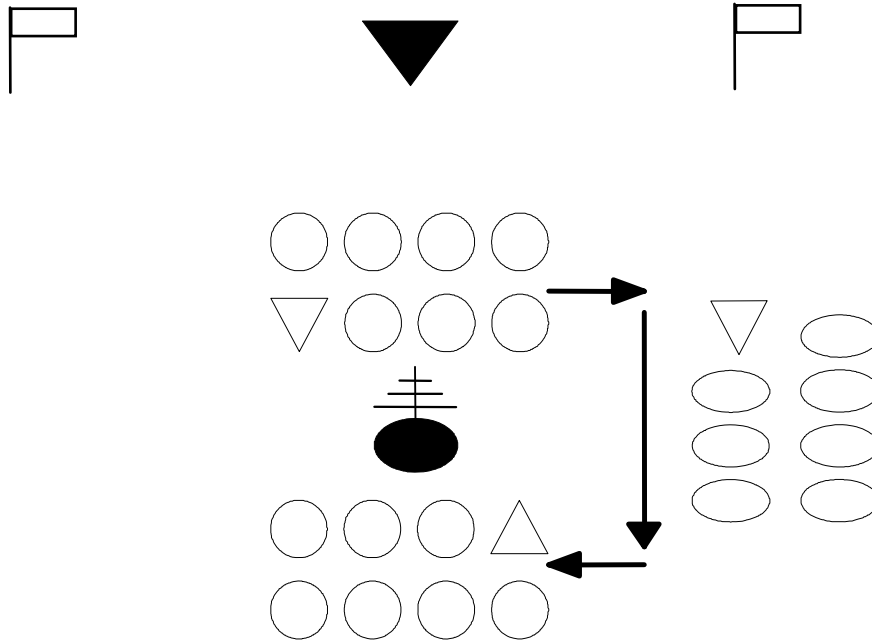

Figure 14-5.--Boxing the Staff.

- 4. During a parade or ceremony that requires the colors are brought forward the staff moves to one side (see figure 14-6, left side) on the commanders command of **"Personnel to Receive Awards, be Retired, etc., and All Colors, Center, MARCH"** in the following sequence:
- a. On the commander's command of **"Colors,"** the staff executes carry swords (if armed with swords).
 - b. On the commander's command of **"Center,"** the staff executes a right face.
 - c. On the commander's command of **"MARCH,"** the staff steps off and marches forward 8-10 paces. (The commander steps off towards the color guard after the staff have cleared.) The adjutant would then command:
 - d. **"Staff, HALT."**

Enclosure (1)

e. **"Staff, Left, FACE."**

Note: The staff does not salute the colors when they pass their position since the colors are passing the staff's flank and not the staff's front.

5. The commander marches forward to the color guard, halts, and salutes the colors and faces about. The commander then marches the color guard forward to the reviewing stand and halts. The Marines to be recognized then move to their position between the commander and color guard, unless marched forward with the color guard. (See chapter 18.)

→ 6. The staff returns to its original position (see figure 14-6, right side) after the color guard has halted using the following commands:

a. **"Staff, Left, FACE."**

b. **"Staff, Forward, MARCH"** (8-10 paces).

c. **"Staff, HALT."**d. **"Staff, Right, FACE."**

e. **"Staff, Order, SWORD"** (if armed with swords).

7. Once the Marines to be recognized are present (see chapter 18) and the staff is back in its position, the commander salutes the reviewing officer and states, "Sir/Ma'am, Personnel to _____ and all Colors are Present."

a. The reviewing officer returns the salute and directs the commander to **"Present the Command."**

b. The commander, goes to carry sword, steps right in marching and moves to a position between the staff and color guard (saluting the colors as he/she passes them) and halts facing the line of troops and commands the unit to **"Present, ARMS."** (See figure 14-6, right side.)

c. The commander then faces the reviewing officer and gives the command **"Staff, Present, SWORD (ARMS)."** The staff, color guard and Marines being recognized salute.

d. After the last note of the music the commander would command **"Staff, Order, SWORD (ARMS)."** The staff, color guard and Marines being recognized terminate their salutes.

e. The commander then faces about and gives the command of **"Order, ARMS"** to the formation.

f. The next command would depend on the particular sequence of events for that particular ceremony.

Enclosure (1)

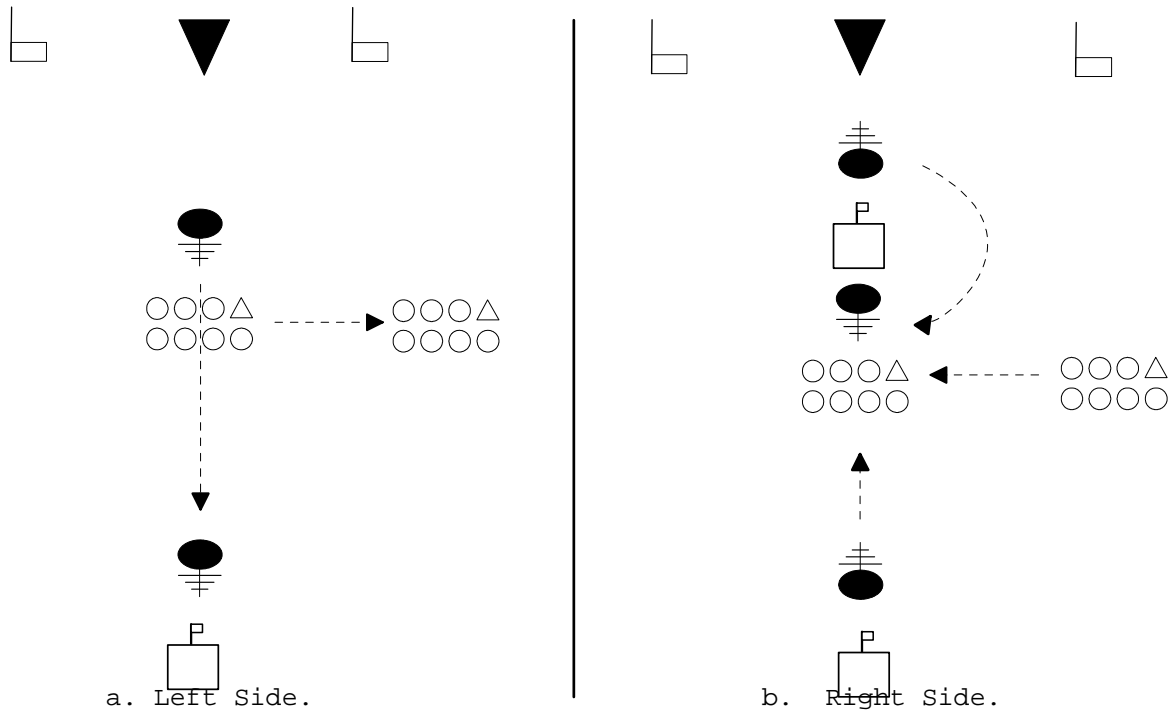

Figure 14-6.—Movements of the Staff When Colors are Brought Forward.

- 8. Once the awards ceremony is completed the commander causes the color guard to return to the line of troops (see figure 14-7, left side), and Marines being recognized to move to their next position by giving the following commands:
- "Staff, Carry, SWORD,"** (if armed with swords) the staff goes to carry swords; the color guard goes to carry color.
 - "Staff, Right, FACE,"** the staff executes a right face the award recipients execute a left face.
 - "Staff, Forward, MARCH,"** the commander and staff march forward 8-10 paces. The color guard executes a countermarch and returns to its position in the line of troops. The Marines being recognized move to their designated position. (See chapter 17.)
 - "Staff, HALT."**
 - "Staff, Left, FACE."**
- 9. The commander returns the staff to its original position after the color guard has cleared that position (see figure 14-7, right side) using the following commands:

- a. **"Staff, Left, FACE."**
- b. **"Staff, Forward, MARCH"** (8-10 paces).
- c. **"Staff, HALT."**
- d. **"Staff, Right, FACE,"** the commander executes a left face to observe the color guard returning to its position.
- e. **"Staff, Order, SWORD,"** (if armed with swords). When the color guard is in position, and at the order, the commander faces the reviewing officer and awaits the next command. (Normally to **"MARCH THE COMMAND IN REVIEW."**)

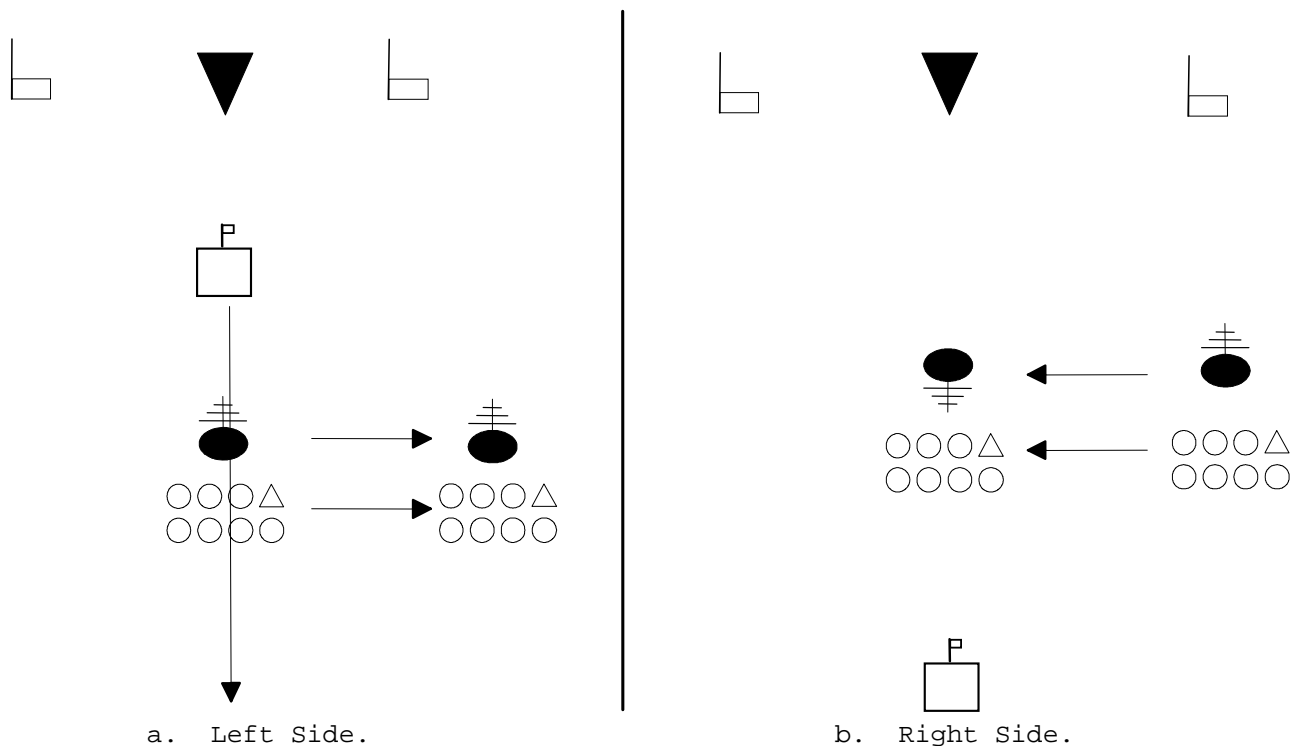

Figure 14-7.--Movements of the Staff for Posting the Colors.

- ➔ 10. When the commander receives the command to **"MARCH THE COMMAND IN REVIEW,"** after exchanging salutes with the reviewing officer, the commander faces the line of troops and gives the command to **"PASS IN REVIEW."**
- a. The command is prepared to pass in review per the selected sequence of events.
 - b. The commander and staff step off when the command of execution **"MARCH"** is given by the commander of the lead element in the parade.

Enclosure (1)

c. The commander and staff marches down the line and execute two left turns in order to be positioned in front of the band. However, subordinate commanders and staffs that are part of a larger parade unit (e.g., regimental parade) would march parallel to the line of troops and execute a left turn in order to be positioned at the head of their command.

d. As commanders and staffs approach the reviewing area each commander gives the command of **"Staff, Eyes, RIGHT (LEFT),"** and as the reviewing area is cleared **"Staff, Ready, FRONT."** When executing eyes right when either armed with a sword or unarmed all members on the command **"Staff, Eyes, RIGHT (LEFT),"** execute either present sword or a hand salute. All members of the staff turn their heads and eyes to the right (left) except the extreme right (left) file.

→ e. The senior commander and staff continue to march down the line of troops to the end of the reviewing area, or other designated point, where they will turn out of the line of march and be positioned to observe the march in review (e.g., they may execute three right turns, see figure 14-8).

f. Subordinate commanders and their staffs, after marching in review, would lead their command from the field.

g. The senior commander, after the staff is halted, commands the staff to **"Staff, Return, SWORD."** The senior commander gives the commands of **"Hand, SALUTE"** and **"Ready, TWO"** as the color guard(s) pass their position.

h. After the rear element of the command (normally the band) has passed the staff's position and exited the field, the commander faces the reviewing officer and salutes. After the salute is returned the commander may:

(1) The commander and the staff draw swords and follow the command from the field.

(2) Dismiss the staff.

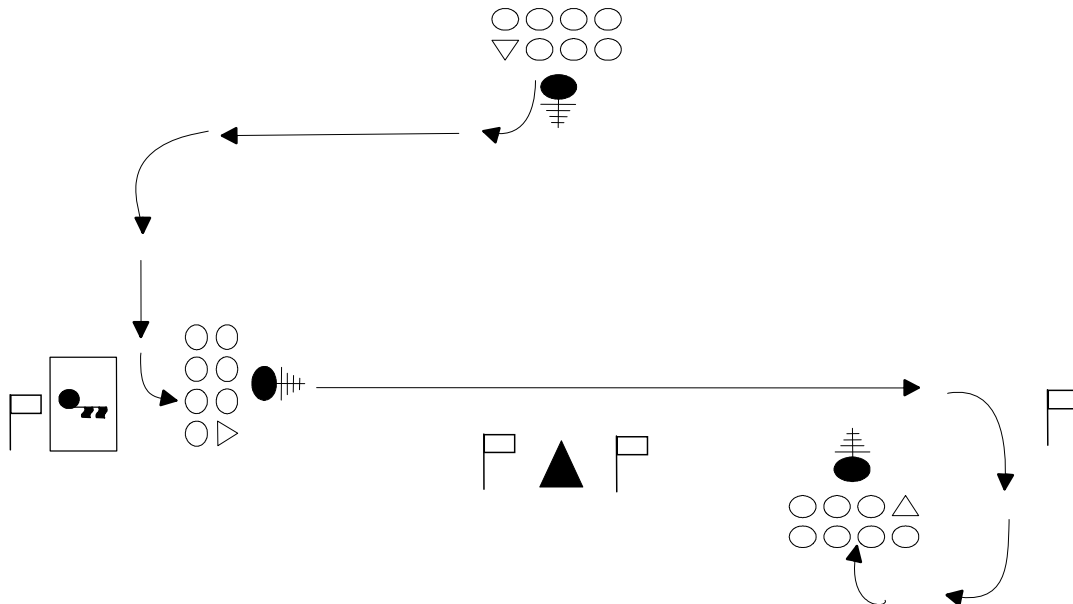

Figure 14-8.--Marching in Review.

Enclosure (1)

14004. DISMISSING THE STAFF. When the commander dismisses the staff, the staff must be at attention and swords returned. The commander, facing the staff, commands "**Staff, DISMISSED.**" The staff would take one step to the rear with the left foot, halt and execute a hand salute. The commander would return the salute. The staff would terminate the hand salute, face about and depart.

MARINE CORPS DRILL AND CEREMONIES MANUAL

PART II: CEREMONIES

CHAPTER 15

GENERAL INFORMATION

	<u>PARAGRAPH</u>	<u>PAGE</u>
GENERAL	15000	15-3
ARRANGEMENT OF UNITS IN FORMATION	15001	15-3
PLACE OF FORMATIONS	15002	15-4
ORGANIZATIONS AND STRENGTH OF UNITS	15003	15-5
COMMANDS, DRILL MOVEMENTS, AND UNIT FORMATIONS	15004	15-5
UNIFORM AND EQUIPMENT	15005	15-5
CEREMONIES CONDUCTED INDOORS	15006	15-5
MARKING PARADE FIELDS	15007	15-6
KEY PERSONNEL AND REHEARSALS	15008	15-9
CEREMONIAL ATMOSPHERE	15009	15-10
CEREMONIAL CHECKLIST	15010	15-11

FIGURE

15-1	FINDING THE CENTER OF THE FIELD	15-7
15-2	SAMPLE MARKING FOR COMPANY IN LINE	15-7
15-3	SAMPLE MARKING TO FORM A COMPANY MASS FROM A COMPANY COLUMN	15-8
15-4	SAMPLE MARKING FOR THE ADJUTANT, COMMANDER OF TROOPS AND STAFF	15-8
15-5	CEREMONIAL CHECKLIST	15-11

MARINE CORPS DRILL AND CEREMONIES MANUAL

PART II: CEREMONIES

CHAPTER 15

GENERAL INFORMATION

15000. GENERAL

1. There are numerous occasions for the conduct of a ceremony but all are special events to celebrate or honor units or deserving individuals. These ceremonies will normally be conducted as a review, parade or indoor ceremony as outlined in chapters 16 and 17. The following are specific occasions for a ceremony and details for each can be found in chapters 18 through 21, and chapters 23 and 24.

- a. Presentation of decorations and individual retirements.
- b. Change of command ceremony
- c. Relief and appointment of the Sergeant Major.
- d. Activation and/or deactivation of a unit.
- e. Marine Corps birthday cake cutting ceremony.
- f. Unit mess night or dining-in.

2. Military funerals and memorial services are ceremonies conducted per the provisions of chapter 25 with the procedures for firing details outlined in chapter 26.

15001. ARRANGEMENT OF UNITS IN FORMATION

1. In ceremonies involving the U.S. Marine Corps and U.S. Navy units, the Marine unit shall be on the right of line or head of the column. The senior line officer, regardless of service, functions as the commander of troops.

2. In ceremonies involving other services of the United States, the order of formation from right to left in line and front to rear in column is as indicated below. The senior line officer, regardless of service, functions as the commander of troops.

- a. Cadets, United States Military Academy.
- b. Midshipmen, United States Naval Academy.
- c. Cadets, United States Air Force Academy.
- d. Cadets, United States Coast Guard Academy.
- e. United States Army.
- f. United States Marine Corps.
- g. United States Navy.

- h. United States Air Force.
 - i. United States Coast Guard.
 - j. Army National Guard of the United States.
 - k. Army Reserve.
 - l. Marine Corps Reserve.
 - m. Naval Reserve.
 - n. Air National Guard of the United States.
 - o. Air Force Reserve.
 - p. Coast Guard Reserve.
 - q. Other training organizations of the Army, Marine Corps, Navy, Air Force, and Coast Guard in that order, respectively.
 - r. During any period when the United States Coast Guard shall operate as part of the United States Navy, the Cadets, United States Coast Guard Academy, the United States Coast Guard, and the Coast Guard Reserve shall take precedence, respectively, next after the Midshipmen, United States Naval Academy, The United States Navy; and the Naval Reserve.
3. When foreign troops are invited to participate in ceremonies within the territorial jurisdiction of the United States, they will be assigned a position of honor ahead of United States troops. A small detachment of United States troops will immediately precede the foreign troops as a guard of honor.
4. When troops of two or more foreign nations participate, the order of precedence among them will be determined, except for the provisions of paragraph 15001.3 above, by the commander of troops per one of the following methods, whichever is deemed most appropriate:
- a. The relative ranks of the commanders of the forces from which the ceremonial detachments are drawn.
 - b. The relative ranks of the commanders of the ceremonial detachments.
 - c. The alphabetical order in the English language of the names of the nations concerned.
5. After troops are formed, subordinate commanders and their staffs face front. The commander of troops and the staff face the command. The commander of troops and the staff face front to present the command to the reviewing officer.

15002. PLACE OF FORMATIONS

1. At "Assembly," companies are formed and inspected by their company commanders at their designated assembly area.

2. At "Adjutant's Call," for a ceremony involving a single battalion, the battalion forms in its assembly area and conducts the ceremony. For a regimental ceremony, at the first "Adjutant's Call," each battalion forms in its assembly area and the battalion reports to its commander. At the second sounding of "Adjutant's Call," the regiment is formed and the ceremony is conducted.

3. For ceremonies conducted by organizations larger than a regiment, such as a division, at the second "Adjutant's Call," each regiment is formed and is reported to its commander. At the third "Adjutant's Call," the command is formed and the ceremony is conducted.

15003. ORGANIZATIONS AND STRENGTH OF UNITS

1. For formations, reviews, and parades when maximum troop participation is desired, units are organized, in as much as practicable, according to their actual tables of organization. Size of units will vary according to actual strengths as will the number of companies in each battalion and platoons in each company. Similarly, the number of ranks in each platoon will vary according to the number of squads. For units not organized by table of organization into squads, they should be formed so that platoons are in three ranks in line and three files in column.

2. When the appearance of troops in formation is of primary concern, the organization and strength of participating units should be standardized. Each platoon should be organized so as to form in three ranks in line and three files in column. The strength of each platoon should be the same so that, when in line, all platoons occupy the same frontage.

15004. COMMANDS, DRILL MOVEMENTS, AND UNIT FORMATIONS

1. During ceremonies, unit commanders give commands, units execute drill movements, and units employ formations as prescribed for squad, platoon, company, battalion and regimental drill.

2. Commanders may modify formations for ceremonies when the nature of the ground or exceptional circumstances requires such changes. Normally, modifications are generally limited to adjusting the paces specified for intervals and distances in a given formation to fit the ground used for conduct of the ceremony.

15005. UNIFORM AND EQUIPMENT. The organization, uniform, arms and equipment of units participating in ceremonies, along with any other necessary administrative information, are prescribed by the commander of troops, or may be prescribed by unit standing operation procedure to preclude the necessity of frequent repetition in individual ceremony orders. Commanders will not designate any of the above when it will be in direct violation of other applicable Marine Corps orders, i.e., Marine Corps Uniform Regulations.

15006. CEREMONIES CONDUCTED INDOORS

1. In addition to reviews and parades conducted per chapters 16 and 17, there will be occasions when an indoor ceremony would be more appropriate or necessary, as is the case during inclement weather. Indoor ceremonies can be conducted for change of command, relief and appointment of the sergeant major, awards, retirement, activation and deactivation of units, honors, promotions, and the graduation of

formal schools. If the ceremony is conducted in a large structure such as a gymnasium or hanger, many of the elements of a review or parade may be used. However, if the location for the indoor ceremony is a banquet hall, theater, auditorium, or classroom and space is limited, then the ceremony will be modified using the following guidelines.

a. At a minimum the indoor ceremony may contain the following elements in the order shown.

- (1) Pre-ceremony music (optional).
- (2) Invocation (optional).
- (3) "*National Anthem*" (see paragraph 15006.2).
- (4) Honors (as required).

(5) At this point the ceremony will proceed depending on the occasion. Colors are passed for a change of command; the sergeants major are relieved and appointed; awards, retirements and promotions are effected; diplomas or certificates for graduations are delivered.

(6) Remarks if appropriate (remarks may also be done prior to the procedures outlined in paragraph 15006.1a above for graduation ceremonies).

(7) Benediction (optional).

→ (8) "*Anchors Aweigh*" and "*Marines' Hymn.*"

2. Color Guard. For indoor ceremonies the color guard may be omitted and colors pre-staged in flag stands per the procedures in chapter 7. If colors are used the procedures outlined in paragraph 7307 will be followed.

3. When special circumstances, such as the use of gymnasiums, hangars, and hangar bays dictate, the commander may direct that participants remain covered and render appropriate salutes as required for the particular ceremony. In such instances, commanders will detail the specific requirements for remaining covered and rendering appropriate salutes.

15007. MARKING PARADE FIELDS

1. Parade fields may be marked using paint, chalk, circular markers (coffee can lid) or any other means at the unit's disposal. Conditions and type of surface of the parade field must also be taken into consideration prior to marking. For instance, if a grass field is used, and it is to be mowed prior to the ceremony, then paint would be a better choice than circular markers, which may damage mowing equipment. Additionally, if more than one unit of a different size uses the parade field, chalk may be a better option than paint.

2. The line on which troops are to form and along which they are to march is marked out or otherwise designated by the unit's sergeant major or senior enlisted assisted by the unit's G/S-3. The post of the reviewing officer, opposite the center of the line of troops, is marked on each flank with a dress guidon that is 6 paces from the line of march. The corners of the parade field are also marked with dress guidons. Additionally, the posts of the commander of troops, adjutant(s), subordinate unit commanders, guides, the color guard, officers center and turning points should be marked.

Enclosure (1)

3. To begin marking a field for a ceremony, first determine the location of the reviewing officer; this becomes the centerline for the field. From the reviewing officer's location, move approximately 100 paces directly to the front. This spot is the location of the color guard that should always be centered on the reviewing officer's spot. Begin marking the line of troops from the color guard's spot outboard to ensure the formation is symmetrical. (See figure 15-1.)

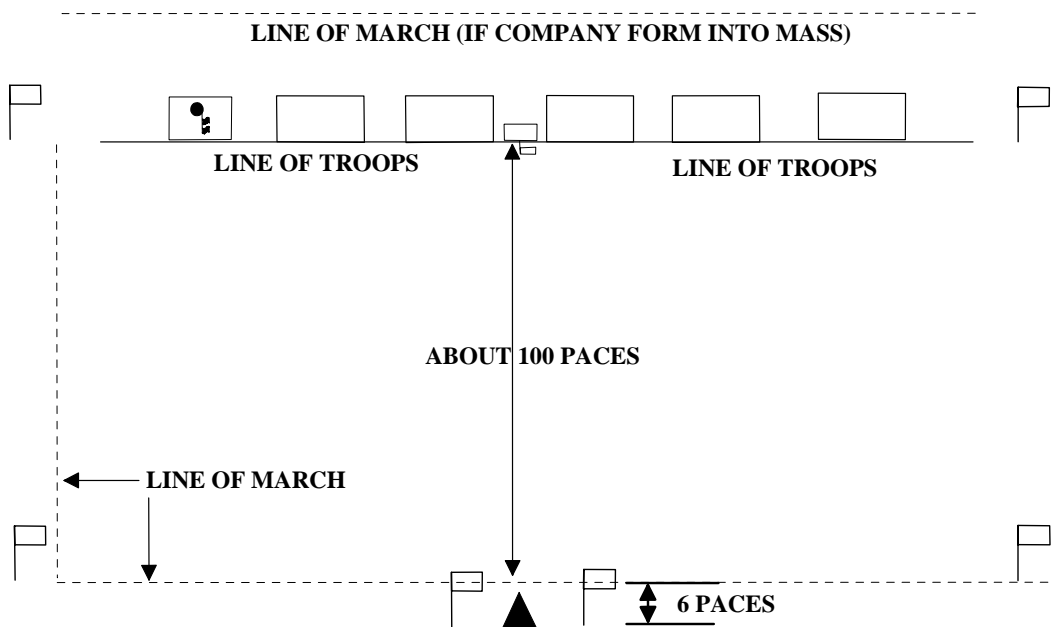

Figure 15-1.--Finding the Center of the Field.

4. The next positions to be marked are where the subordinate units are to come to rest on the line of troops. For a battalion size unit the minimum markings are, guide on line, squad leaders, platoon commanders, company guides and company commanders. Examples of markings for a company in line, platoons on line are shown in figure 15-2. Examples of markings for forming a company in mass from a company in column are shown in figure 15-3.

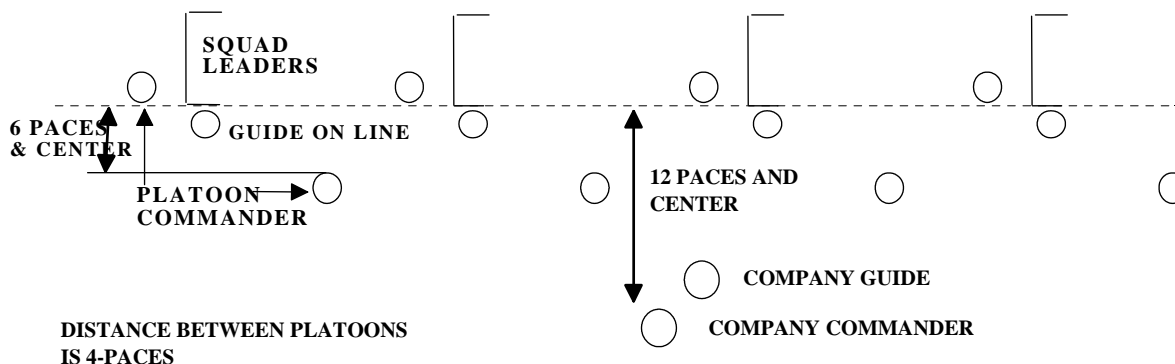

Figure 15-2.--Sample Marking for Company in Line.

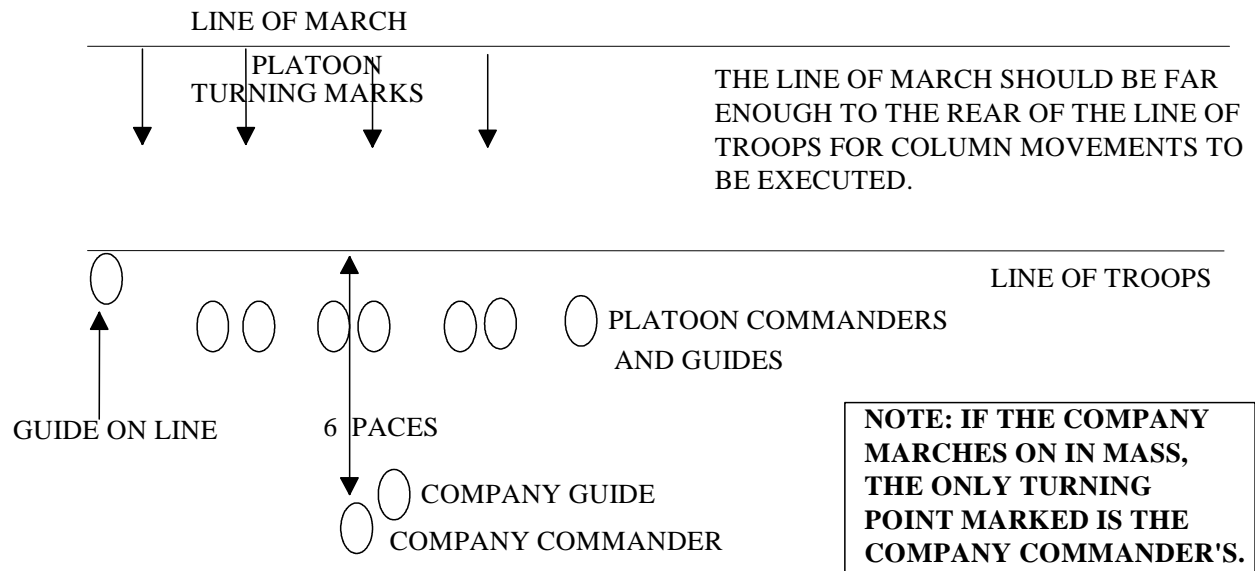

Figure 15-3.--Sample Marking to Form a Company Mass from a Company Column.

5. After the positions for all marching elements of the ceremony are marked the positions of the adjutant, commander of troops and staff to include subordinate commanders and staffs. (See figure 15-4.)

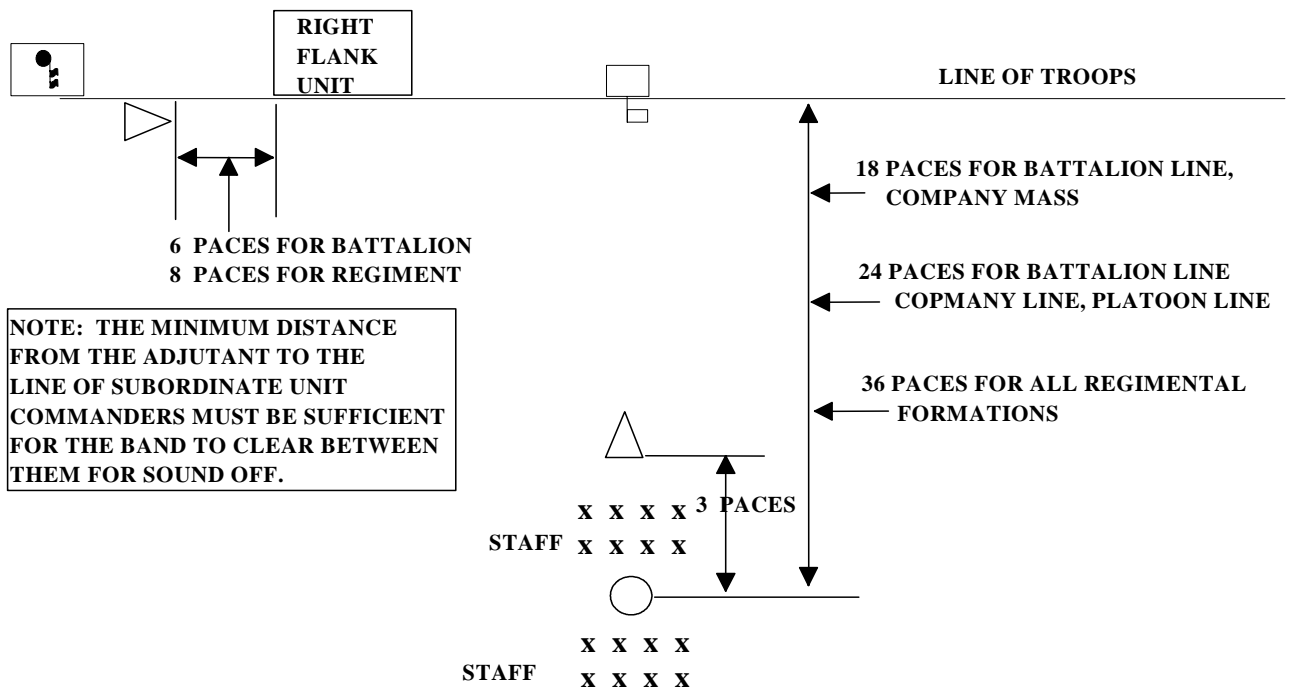

Figure 15-4.--Sample Marking for the Adjutant, Commander of Troops and Staff.

6. The final marking would be for officer's center. During officer's center, battalion commanders, and their staffs, company commanders, company guides and platoon commanders march directly to the center from their position in formation at the command march. Company commanders oblique slightly forward so that they are 4 paces ahead of the line of company guides. Usually a single long line (with Xs where the officers/guides halt) for each rank is marked on the field.

7. The minimum personnel needed to assist marking the field is the same as the number of Marines that comprise the "front" of each unit in the formation, plus two. For example to mark a company in line, platoons in line, 15 Marines are needed, 13 to mark the squad front, 1 for the platoon commander's position, and 1 for the platoon sergeant's position, in order to get the appropriate 4 paces between the platoons.

15008. KEY PERSONNEL AND REHEARSALS

1. While not inclusive the key personnel for parade rehearsals normally consist of the following:

- a. Commander of troops and staff.
- b. Adjutant(s).
- c. Subordinate commanders and staffs.
- d. Color guard.
- e. Company commanders.
- f. Company guides.
- g. Platoon commanders.
- h. Platoon sergeants.
- i. Platoon guides.
- j. Squad leaders.
- k. Award recipients/retirees etc.
- l. Narrator.

2. In order to conduct a successful parade or ceremony sufficient rehearsals must be conducted. Normally, due to transportation; time spent drawing weapons; etc., only one all hands rehearsal is needed. The Marines participating in formation should be drilled in the manual of arms, marching in review, etc., in their company area in order to preclude excessively long or multiple all hand rehearsals. Key personnel are rehearsed exhaustively since they will make or break a parade or ceremony.

3. Key personnel rehearsals are usually scheduled in 2-hour blocks. The reason is that most parade sequence of events, less awards, speeches, etc., last from 35-45 minutes, depending on the size of the unit. Scheduling 2-hour blocks for rehearsals allows sufficient time to go over the sequence at least twice per rehearsal period. Normally key personnel rehearsals are conducted as follows:

a. The initial key personnel rehearsal is more of a class or "chalk talk" than an actual rehearsal. This chalk talk should clear up any fine points of the ceremony as well as clearly establishing who is in charge of the parade. The key personnel are briefed by senior enlisted concerning all aspects of the sequence of events for the parade as well as refresher training on the following:

- (1) The movements of the adjutant.
- (2) The movements of the commander of troops and staff.
- (3) The movements of the platoon commanders on dress right.
- (4) The movements of the guides on guides post.
- (5) The sword manual if so armed.

(6) If armed with swords, the officers and company guides are shown how to do a four-count halt at officer's center.

(a) On the first two counts, the officers and guides execute a halt.

(b) On the third count the officers execute the first count of present swords.

(c) For the fourth count the officers execute the second count of present swords and the company guides present guidons.

(7) If not armed with swords, the officers and company guides are shown how to do a four-count halt at officer's center.

(a) On the first two counts, the officers and guides execute a halt.

(b) On the third count all members will pause.

(c) On the fourth count the officers execute a hand salute and the company guides present guidons.

(8) The officers and company guides are shown the movements to return from officers center.

(9) Passing in review.

b. The second key personnel rehearsal should be a walk through of the sequence of events without repeating movements incorrectly executed. This rehearsal's sole purpose is to establish the sequence of events in the minds of all key personnel.

c. Third and subsequent key personnel rehearsals work on the polish of each movement made during the parade and ceremony. (e.g., officers center, dress right, box the staff, etc.)

15009. CEREMONIAL ATMOSPHERE. On the day of the ceremony it is appropriate to create something called "Ceremonial Atmosphere." This should be done approximately 45 minutes prior to the ceremony. At this time all fixed installations should be

in place to include, dress guidons, the firing battery, tentage, seating, etc. If there are buildings adjacent to the ceremony area then care must be taken to place windows, blinds, and curtains in the same position for uniformity. Excess gear should be removed. Sentries should be posted to prevent persons from entering the ceremonial area during the period when the ceremony is being conducted.

15010. CEREMONIAL CHECKLIST. Figure 15-5 is a sample ceremony execution checklist that can be used when planning various types of ceremonies. It is based on a 60-day reverse planning timeline. This sample can be modified to fit local requirements and timelines.

<u>DATE</u>	<u>SECTION</u>	<u>ACTION REQUIRED</u>	<u>REMARKS</u>
C-60	CG/CO	Identify type of ceremony and date of event	_____
C-58	G/S-3	Request band for ceremony and to provide taped music for rehearsals. Ensure band support includes one rehearsal and a 20-minute concert prior to the start of ceremony.	_____
C-45	G/S-3	Publish 5060 bulletin or LOI.	_____
C-45	G/S-1	Request guest lists as appropriate for those being honored.	_____
C-40	G/S-3	Chair parade coordination meeting.	_____
C-30	G/S-1	Consolidate guest list and mail all invitations. Prepare RSVP roster for use by phone watches.	_____
C-30	G/S-1	Acquire biographies and photographs for those being honored for inclusion in the program.	_____
C-30	G/S-1	Submit proposed program for review.	_____
C-30	G/S-3	Request photographic coverage, still and video from local CVIC.	_____
C-30	G/S-3	Request "Quiet Hours" from appropriate agencies.	_____
C-30	G/S-1	Prepare a "Narration" for the ceremony, include copies of orders, award citations, retirement certificates, and spouse LOAs as required.	_____

Figure 15-5.--Ceremonial Checklist.

<u>DATE</u>	<u>SECTION</u>	<u>ACTION REQUIRED</u>	<u>REMARKS</u>
C-30	G/S-4	Request tentage, seating and other requirements identified in the Bulletin/LOI.	_____
C-30	G/S-4	Request "Quiet Hours" from civilian contractors.	_____
C-20	G/S-3	Ensure final coordination has been made with all units to deconflict scheduling problems.	_____
C-15	G/S-1	Coordinate with chaplain's office to identify who will provide invocation for ceremony.	_____
C-15	Comdrs	Provide G/S-3 with a by name list of key personnel.	_____
C-15	G/S-1	Deliver program to Defense Printing Service ensure pickup.	_____
C-15	G/S-3	Pick up copy of rehearsal tape with ceremony music from band.	_____
C-15	G/S-1	Request PAO coverage, provide copy of "Narration" to PAO.	_____
C-15	G/S-3	Coordinate traffic and force protection measures with military police.	_____
C-15	G/S-1	Identify if a reception is being held.	_____
C-14	G/S-4	Request mowing of parade field and surrounding areas.	_____
C-14	G/S-4	Develop parking plan and coordinate with G/S-3.	_____
C-10	G/S-6	Provide a public address system for the rehearsals and ceremony, to include a cassette player for rehearsal music.	_____
TBD	G/S-3	Brief CG/CO on conduct of the ceremony.	_____
C-10	G/S-1	Provide a copy of the "Narration" to the narrator.	_____
C-10	G/S-3	Ensure parade field is marked, coordinate with SgtMaj.	_____

Figure 15-5.--Ceremonial Checklist--Continued.

<u>DATE</u>	<u>SECTION</u>	<u>ACTION REQUIRED</u>	<u>REMARKS</u>
C-10	Supply	Complete issue of parade gear, i.e., swords, frogs, belts as required.	_____
C-10	G/S-4	Coordinate with Armory and Comdrs for drawing weapons for the ceremony and final rehearsal.	_____
C-7	G/S-1	Begin preparation of VIP seating chart.	_____
C-7 to C-1	G/S-3 SgtMaj	Conduct key personnel rehearsal.	_____
C-5	G/S-1	Ensure completion and pick up program from the Defense Printing Service.	_____
C-3	Designated Units	Provide a working party to prepare parade field.	_____
C-3	G/S-4	Set up fly tents, chairs, and bleachers.	_____
C-3	Designated Units	Provide escorts and ushers.	_____
C-3	G/S-1	Coordinate purchase and delivery of flowers by COs, SgtMajs, or retiree.	_____
TBD	Arty	Coordinate with SgtMaj for final placement of saluting battery.	_____
C-1	G/S-3 SgtMaj	Conduct an all hands rehearsal without band.	_____
C-1	G/S-3 SgtMaj	Conduct an inclement weather with key personnel if required.	_____
C-1	G/S-4	Ensure completion of mowing, trimming, police of area, and conduct an inspection.	_____
C-1	G/S-3 G/S-4	1500 rehearse traffic control plan with road guard detail and VIP parking escorts.	_____
C-1	G/S-1	Coordinate last minute changes to the seating chart.	_____
C-1	G/S-4	Make final coordination with civilian contractors for "Quiet Hours."	_____

Figure 15-5.--Ceremonial Checklist--Continued.

<u>DATE</u>	<u>SECTION</u>	<u>ACTION REQUIRED</u>	<u>REMARKS</u>
C-Day	G/S-4	Wipe down bleachers, setup cold water dispensers w/cups behind each seating area, and check police of area. Ensure parking lots are marked.	_____
C-Day	G/S-1	Take delivery of flowers for spouses.	_____
C-Day	G/S-4	Post traffic signs at designated intersections and road guards at appropriate time.	_____
C-Day	G/S-3	Ensure corpsman and ambulance are in place.	_____
C-Day	G/S-1	Label VIP seating area and brief ushers on duties to include those designated to deliver flowers, and tasked with VIP parking duties.	_____
C-Day	G/S-3	Make final decision on implementing weather plan. Make frost calls as required if implemented.	_____
C-Day	G/S-1	Have Marine designated for break-out briefed and standing by.	_____
C-Day	G/S-4	Ensure windows and shades in the buildings around the ceremony area are closed.	_____
H-30	Band	Pre-ceremony concert begins.	_____
H-15	COT/Staff	In position near the reviewing area.	_____
H-Hour	CG/CO	Ceremony begins.	_____

Figure 15-5.--Ceremonial Checklist--Continued.

MARINE CORPS DRILL AND CEREMONIES MANUAL

PART II: CEREMONIES

CHAPTER 16

REVIEWS

	<u>PARAGRAPH</u>	<u>PAGE</u>
GENERAL	16000	16-3
ELEMENTS OF A REVIEW	16001	16-3
DIFFERENCES BETWEEN A PARADE AND A REVIEW	16002	16-3
COMMAND OF TROOPS	16003	16-3
PREPARATIONS	16004	16-4
FORMATIONS	16005	16-4
FORMING FOR THE REVIEW	16006	16-5
REVIEWING PARTY	16007	16-6
SEQUENCE OF EVENTS FOR A REVIEW	16008	16-7

FIGURE

16-1	TROOP FORMATIONS.	16-4
16-2	REVIEWING PARTY	16-6
16-3	FORMATION ON THE LINE OF TROOPS AND BAND MOVEMENT	16-8
16-4	ADJUTANT TAKES POST	16-9
16-5	ADJUTANT, COMMANDER OF TROOPS AND STAFF MOVE TO CENTER OF FIELD	16-10
16-6	ROUTE OF MARCH FOR THE INSPECTING PARTY	16-14

MARINE CORPS DRILL AND CEREMONIES MANUAL

PART II: CEREMONIES

CHAPTER 16

REVIEWS

16000. GENERAL. Reviews, when practicable, are held on the following occasions:

1. The presentation of United States or foreign decorations.
2. The decoration of organizational colors.
3. The retirement of an individual or group of any rank. Local commanders should consider it appropriate, when only one distinguished individual is retiring, to allow that individual to participate as the reviewing officer.

16001. ELEMENTS OF A REVIEW. A review consists of four parts:

1. Formation of troops.
2. Presentation of the command to the reviewing official. This includes an inspection of the troop formation (trooping the line).
3. Presentation of decorations and retirements.
4. March in review.

16002. DIFFERENCES BETWEEN A PARADE AND REVIEW

1. The sequence of events for a parade contains the following elements that a review does not contain.
 - a. March on of troops (optional for a review).
 - b. "Sound Off."
 - c. Manual of arms.
 - d. Receive the report.
 - e. Officers center.
2. The sequence of events for a review contains an inspection (trooping the line) and a parade does not.

16003. COMMAND OF TROOPS. The senior officer taking part in a ceremony is designated as the commander of troops. The commander of troops is responsible for the formation, presentation, and march in review. When a commander reviews the troops, the commander designates another officer as commander of troops. When the review is given for an important visitor or senior commander, the local commander designates another officer as commander of troops so the local commander may accompany the visitor or senior officer during the review.

16004. PREPARATIONS. The line on which troops are to form and along which they are to march is marked out or otherwise designated by the sergeant major or senior enlisted of the unit. The post of the reviewing officer, opposite the center of the line of troops, is marked on each flank with a dress guidon. Chapter 15 shows examples of the minimum marking for parades and reviews.

16005. FORMATIONS

1. The troops may be formed prior to the start of a review or marched on at the beginning of the review. Troops form in line for a review. Battalions and regiments may form in line with companies in line or with companies in mass formation. (See chapters 11 and 12.) When space is limited, for reviews conducted by regiments and larger organizations, the formation may be in line with battalions and independent companies in mass formation. Such formations may be modified when necessary because of space available or other exceptional circumstances. The initial formation will also influence the formation in which troops are to march in review. (See figure 16-1.)

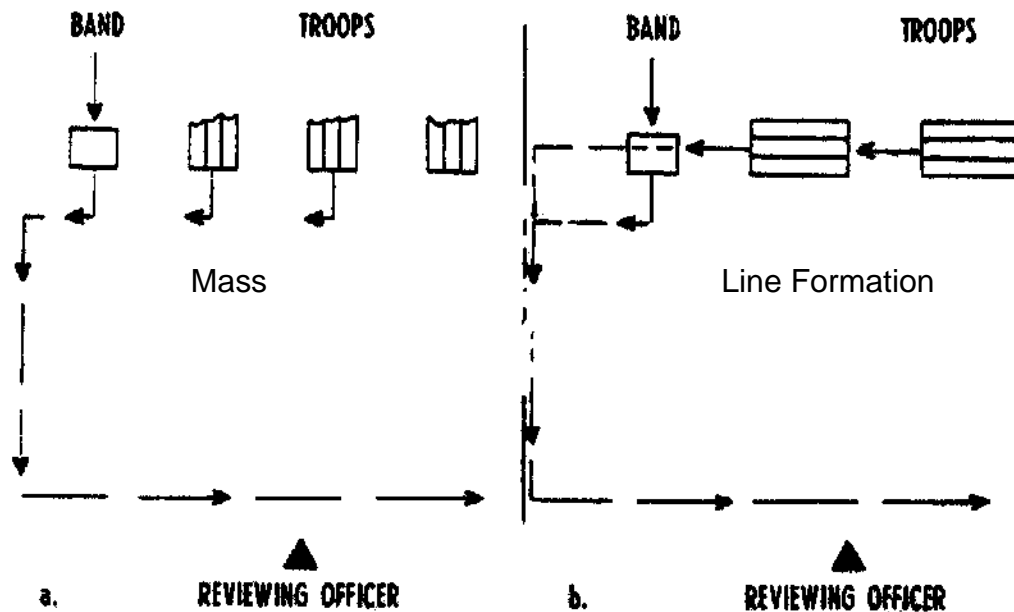

Figure 16-1.--Troop Formations.

2. In reviews involving two or more arms or types of organizations, troops are arranged as directed by the commander of troops. The following order, from right to left in line, may be used as a guide: infantry units, artillery, tanks, and motorized or service units. The provisions of paragraph 15001 also apply in reviews consisting of units from different services of the United States or foreign nations.

3. Arrangements should be made to provide for forming normal march columns after passing in review. An area should be designated where this can be accomplished without blocking the line of march of units that have not yet passed in review. Unless otherwise directed by the commander of troops, after passing in review, units revert to the control of their respective commanders.

16006. FORMING FOR THE REVIEW

1. Forming for a Battalion or Regimental Review. Initial forming for a review for a battalion or regiment with a march on is conducted per provisions of chapters 11 and 12.

a. If the unit is marched on at the beginning of the review, the sequence of events is the same as for a parade up to and including the adjutant's command of guide's post. The next step in the sequence would be for the adjutant to present the command to the commander of troops. The sequence would continue as in paragraph 16008.1.

b. If the unit is formed prior to the start of a review use the sequence of events in paragraph 16008.2.

c. Prior to presenting the command to the commander of troops the colors may be trooped as described in paragraph 7306.

d. If not at an evening review including "*Retreat*," after the command has been presented to the commander of troops and the staff boxed the reviewing officer will assume the designated position.

→ e. If at an evening review including "*Retreat*," after the command has been presented to the commander of troops and returned to order arms, the staff is not boxed. Instead, the commander of troops commands "**Present, ARMS,**" then when all troops are at present arms, commands "**SOUND RETREAT**" (or gives a prearranged signal to the band) at the time prescribed for evening colors. The band plays "*Retreat*" and then the "*National Anthem*" immediately afterwards. The flag is lowered during the "*National Anthem*" as prescribed in 7003. The commander of troops and the staff face the formation throughout this portion of the sequence. After the last note of the "*National Anthem*" the commander of troops and staff terminate their salutes and the commander of troops commands "**Order, ARMS.**" The staff is then boxed and the review continues as outlined in paragraph 16008.

Note: To conduct retreat as part of an evening review, troops must be formed in sufficient time prior to sunset to permit the command to be presented and evening colors to be conducted at the proper time.

2. Forming for Large Reviews

a. For reviews conducted by organizations larger than a regiment, such as a division, the same basic commands, procedures, and sequence of events prescribed above for a battalion or regimental review apply.

b. Normally, in large reviews battalions and independent companies are in mass formation. Troop units take their positions on the line of troops prior to the third "*Adjutant's Call*" being sounded to form for the review. In this regard, at the second "*Adjutant's Call*," regiments may be formed, presented to their commanders, and reports received at their designated locations, or the second "*Adjutant's Call*" may be conducted so that the regiments are formed at their positions on the line of troops for the review. Regardless, in large reviews, the commander of troops should prescribe the routes of march and arrival and departure times. If the frontage of the unit has been measured and marked, they may arrive

Enclosure (1)

independently in any convenient order to occupy their places on line. If this is not done, units must form in succession from the right. Because of the time consumption involved in the latter method, the former is preferred.

c. The commander of troops and adjutant of reviews conducted by organizations larger than a regiment give commands in the same manner as prescribed for a regiment in chapter 12, i.e., in a manner which does not require execution by the troops. In formations consisting of two or more regiments, the regimental commander repeats those commands requiring execution by the troops. Within each regiment, battalions and independent companies execute movements on the command of execution of their respective commanders. Independent battalions not part of a regiment, execute movements on the command of their respective commanders. Movements are executed successively by units from right to left.

16007. REVIEWING PARTY

1. After the staff has been boxed and the commander of troops has faced the reviewing area (see paragraph 16008.3k), the reviewing officer, with the staff (if applicable), moves into position to receive the review.
2. The local commander, distinguished civilians, and the officer and enlisted staff take positions at their posts (see figure 16-2) facing the troops. The officer, who is senior, with the staff, will take position on the right.
3. An officer from the local commander's staff is designated to escort distinguished civilians to their positions. If a civilian is to receive the review, the civilian takes position on the right of the local commander. If necessary, the civilian is given an explanation of the ceremony by an escort or the local commander.

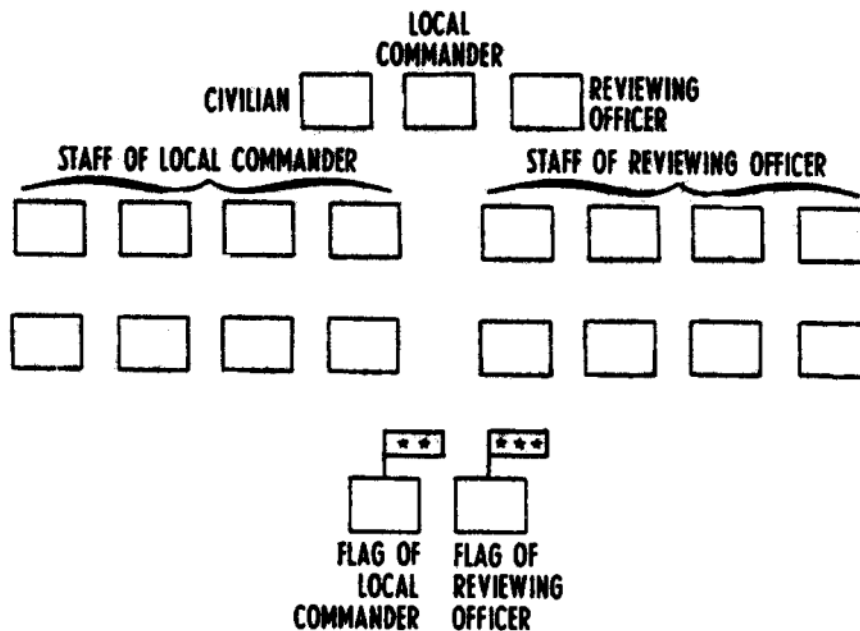

Figure 16-2.--Reviewing Party.

16008. SEQUENCE OF EVENTS FOR A REVIEW

1. March on for a Review. The organization is formed in the staging area. Troops are at parade rest; officers and noncommissioned officers have swords drawn, if so armed.

a. The organizational/review staff is in position near the reviewing stand.

b. For regimental reviews, battalion adjutants take their position behind the line of troops, swords drawn and at parade rest.

c. At H Hour-15 the narrator introduces the band. The band begins pre-review concert.

NARRATOR: "LADIES AND GENTLEMEN, TODAY'S MUSIC IS PROVIDED BY THE _____ BAND UNDER THE DIRECTION OF _____. THE DRUM MAJOR IS _____."

d. At H Hour-5 the band moves to its position on the right of line, countermarches and halts as shown in figure 17-1.

e. The commander of troops forms the staff per chapter 14.

f. At H-Hour the narrator makes opening remarks.

NARRATOR: "GOOD MORNING (EVENING), LADIES AND GENTLEMEN. ON BEHALF OF THE COMMANDING OFFICER (GENERAL), _____, WELCOME TO THE _____ CEREMONY. TODAY'S REVIEW IS BEING EXECUTED BY THE OFFICERS AND MARINES OF _____."

(Optional) **"LADIES AND GENTLEMEN, PLEASE RISE FOR THE INVOCATION BY COMMAND CHAPLAIN _____, UNITED STATES NAVY."**

g. Invocation is given.

(Note: After the invocation) **"LADIES AND GENTLEMEN PLEASE BE SEATED."**

h. Commander of troops commands **"TAKE YOUR POST."**

i. The adjutant moves by the most direct route to position on the line of troops. (See figure 17-2.)

→ Note: At this time, depending on the formation, the command may choose to have the narrator read verbiage similar to the following:

NARRATOR: (AS THE ADJUTANT MOVES INTO POSITION) "PRESENT DAY REVIEWS IN THE MARINE CORPS HAVE THEIR BASIS IN BOTH HISTORY AND TRADITION, THE MASSED FORMATION OF TROOPS ON ONE LONG LINE AT CLOSE INTERVAL, MADE POSSIBLE THE MASSING OF FIREPOWER FROM MUZZLE LOADED MUSKETS OF YESTERDAY. IN THOSE EARLY DAYS, THE LINE OF BATTLE WAS JUST THAT, A LINE OF TWO OR THREE RANKS, AND LOOKED MUCH LIKE THE PARADE FORMATION YOU WILL SEE TODAY. THE ADJUTANT FORMS THE LINE FOR BATTLE."

j. At this point follow the procedures to form a battalion for march on see chapter 11 and to form a regiment see chapter 12.

k. After the unit is formed the guides post. The procedures for a review in paragraph 16008.3 are followed.

Enclosure (1)

2. Units Formed on the Line of Troops Prior to the Start of the Review. The battalion is formed on the line of troops. Alignment is obtained and the unit is placed at parade rest. (See figure 16-3.)

a. At H Hour-15 the battalion staff is in position near the reviewing stand. The narrator introduces the band. The band begins pre-review concert.

→ b. At H Hour-5 the band moves to its position 12 paces to the right of the extreme right unit on the line of troops. (See figure 16-3.)

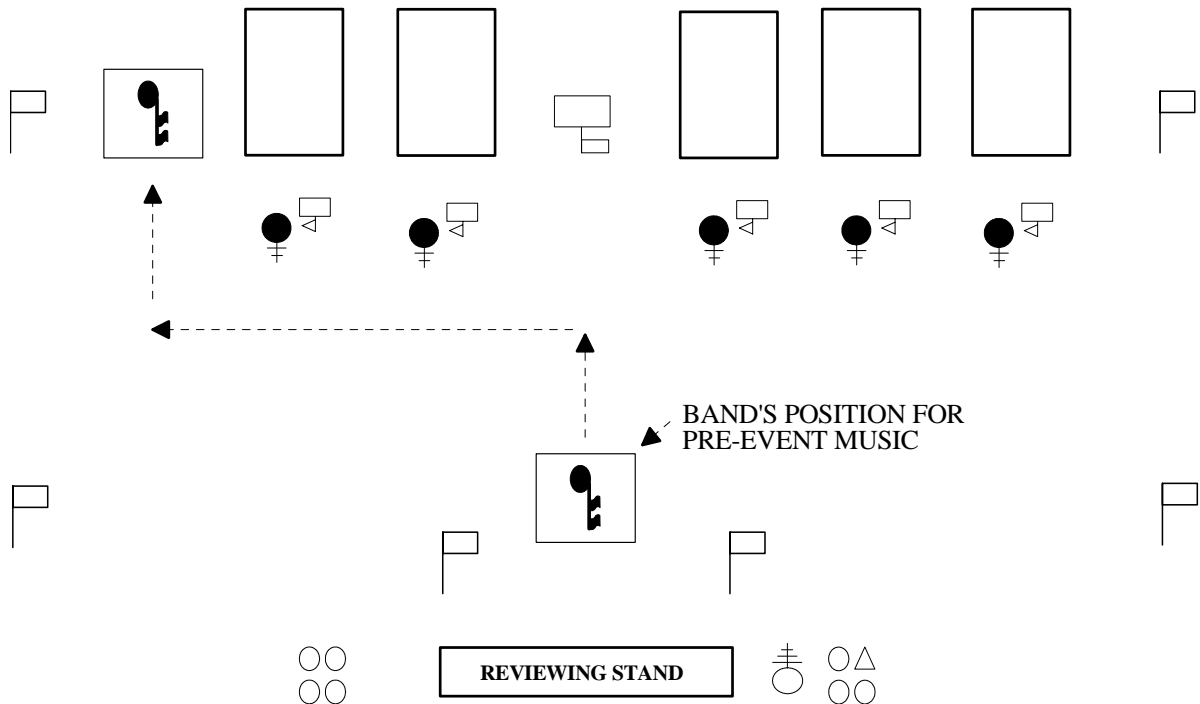

Figure 16-3.--Formation on the Line of Troops and Band Movement.

c. The commander of troops moves to a position centered between the dress guidons, halts, faces the reviewing stands and commands "**Staff, FALL IN.**" The staff moves smartly to their positions. (See figure 14-2.) Once the staff is in position the commander of troops faces about towards the line of troops.

NARRATOR: "GOOD MORNING (EVENING), LADIES AND GENTLEMEN. ON BEHALF OF THE COMMANDING OFFICER (GENERAL), _____, WELCOME TO THE _____ CEREMONY. TODAY'S REVIEW IS BEING EXECUTED BY THE OFFICERS AND MARINES OF _____."

(Optional) "**LADIES AND GENTLEMEN, PLEASE RISE FOR THE INVOCATION BY COMMAND CHAPLAIN _____, UNITED STATES NAVY.**"

d. Invocation is given.

(Note: After the invocation) "**LADIES AND GENTLEMEN PLEASE BE SEATED.**"

e. Commander of troops commands "**TAKE YOUR POST.**"

Enclosure (1)

f. The adjutant moves by the most direct route to position on the line of troops. Once in position the adjutant faces down the line of troops, draws sword and commands. (See figure 16-4.)

NARRATOR: (AS THE ADJUTANT MOVES INTO POSITION) "PRESENT DAY REVIEWS IN THE MARINE CORPS HAVE THEIR BASIS IN BOTH HISTORY AND TRADITION, THE MASSES FORMATION OF TROOPS ON ONE LONG LINE AT CLOSE INTERVAL, MADE POSSIBLE THE MASSING OF FIREPOWER FROM MUZZLE LOADED MUSKETS OF YESTERDAY. IN THOSE EARLY DAYS, THE LINE OF BATTLE WAS JUST THAT, A LINE OF TWO OR THREE RANKS, AND LOOKED MUCH LIKE THE PARADE FORMATION YOU WILL SEE TODAY. THE ADJUTANT FORMS THE LINE FOR BATTLE."

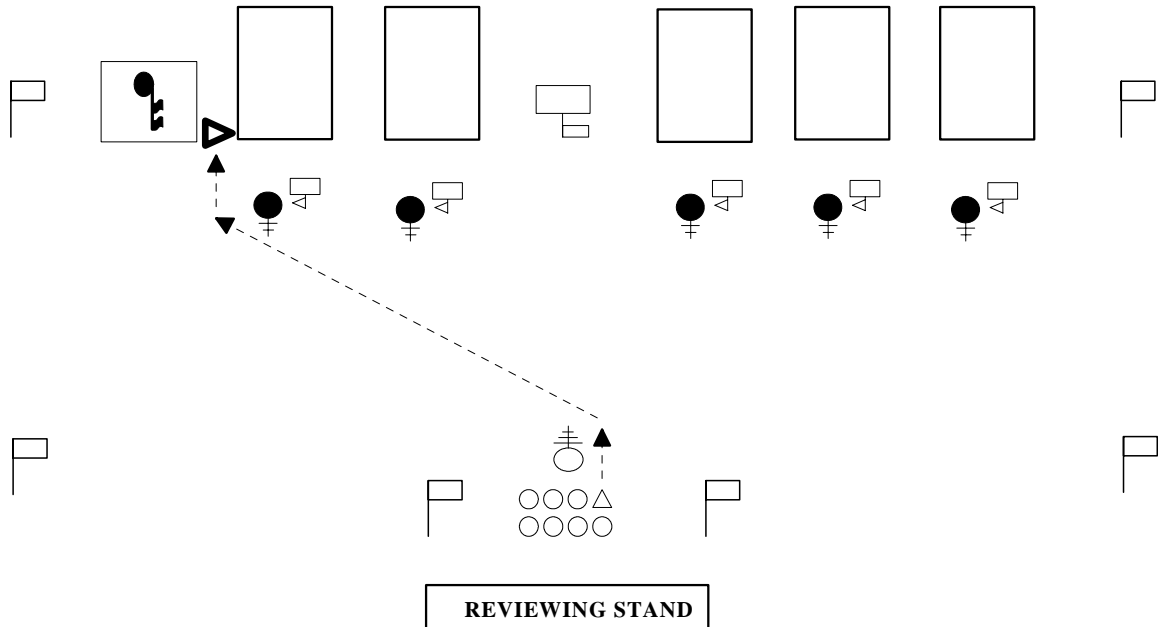

Figure 16-4.--Adjutant Takes Post.

- g. Adjutant commands "**SOUND ATTENTION.**"
- h. The company commanders execute attention, face their companies and in sequence command.
- i. Company commander commands "**Company, ATTENTION.**"
- j. The companies execute the commands. When all companies are at attention the adjutant commands.
- k. Adjutant commands "**SOUND ADJUTANT'S CALL.**"
- l. On the first beat of the music after "*Adjutant's Call*" the commander of troops and staff march to their position on the parade field and halt facing the line of troops. (See figure 16-5.) Once the units have been formed on the line of troops and the command "**Guides, POST,**" has been given (see chapter 11) the adjutant moves to a position 3 paces and centered on the commander of troops and facing the line of troops.

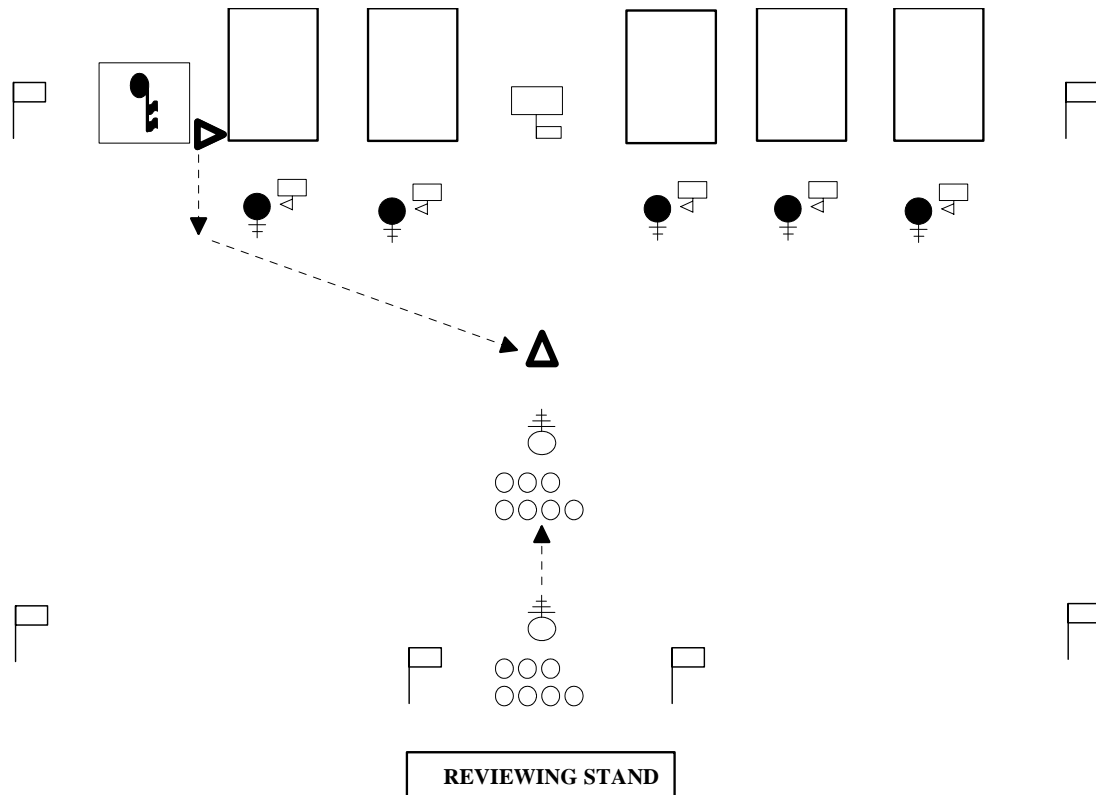

Figure 16-5.--Adjutant, Commander of Troops and Staff Move to Center of Field.

Note: The sequence of events is continued in paragraph 16008.3. It is at this point in time that the sequence of events, whether the troops are pre-staged or marched on is the same.)

3. Presentation and Honors

a. Adjutant commands **"Present, ARMS."**

b. Battalion executes. The color guard riflemen execute present arms, however, the organizational color does not present to the commander of troops. The adjutant then faces the commander of troops, presents sword and reports;

c. Adjutant commands **"SIR/MA'AM THE REVIEW IS FORMED."**

d. The commander of troops returns the adjutant's salute and directs the adjutant.

e. Commander of troops commands **"TAKE YOUR POST SIR."**

→ f. The adjutant executes carry sword, moves to position in the staff, halts, faces the line of troops and goes to order sword. Once the adjutant has halted, the commander of troops commands **"Staff, Draw, SWORD"** and **"Staff, Order, SWORD."**

Enclosure (1)

16-10

Ch 1

- g. The commander of troops then commands the battalion to **"Order, ARMS."**
- h. The battalion executes.
- i. Commander of troops commands **"BOX THE STAFF."**
- j. The adjutant moves the staff to its new position using the following commands: **"Staff, Carry, SWORD;" "Staff, Left, FACE;" "Column Right, MARCH;" "Staff, HALT;" "Staff, Right, FACE;"** and **"Staff, Order, SWORD."**
- k. After the staff is in position the unit commander and/or reviewing officer takes position in the reviewing area. The commander of troops then commands **"Present, ARMS."**
- l. The battalion executes. The color guard riflemen execute **"Present, ARMS."** The organizational color bearer presents colors when and if appropriate. The commander of troops then faces the reviewing area and commands **"Staff, Present, SWORD."**
- m. Staff and commander of troops execute. Musical honors and/or gun salutes are fired if appropriate. The unit commander and/or reviewing officer return the salute. After the last note of musical honors, or the final gun salute, the commander of troops commands **"Staff, Order, SWORD."**
- n. Staff executes. Commander of troops returns to the carry. The commander of troops then faces the line of troops and commands **"Order, ARMS."**

4. Inspection

- a. Battalion and colors execute. The commander of troops then commands **"Parade, REST."**
- b. Battalion and colors execute. The band remains at attention. The commander of troops then faces the reviewing area and goes to order sword. The unit commander and/or reviewing officer (inspecting party) then move forward to the commander of troops.
- c. The commander of troops presents sword and reports **"SIR/MA'AM, THE BATTALION IS FORMED FOR INSPECTION."**
- d. The unit commander and/or reviewing officer returns the salute. The commander of troops terminates the salute and then executes return sword.
- e. The inspecting party and commander of troops step off towards the extreme right flank (normally the band) of the formation. They march as one rank with the senior member of the inspecting party on the right and the commander of troops on the left.
- f. If the inspection is to be made in vehicles, the reviewing party embarks at the post of the reviewing officer. The reviewing officer enters first and occupies the left rear position. The unit commander occupies the right rear position. The

vehicle then moves to the commander of troops position, approaching from the left, and stops. The commander of troops then salutes, reports, returns sword, and enters the vehicle in the right front position. The adjutant would then command the staff, **"Staff, Parade, REST."** (Figure 16-6 shows the route of march for the inspecting party.)

g. Band plays martial music during the inspection.

h. When the inspecting party reaches the right flank of the formation they change order of precedence from left to right (reviewing officer, unit commander, commander of troops).

i. The inspecting party marches down the line of company commanders.

Note: If the formation is a company line formation the inspecting party would march down the line of platoon commanders.

j. As the inspecting party approaches the left flank of the company the company commander goes to carry sword, faces the company and commands **"Company, ATTENTION."**

k. Company executes. The company commander then commands **"Eyes, RIGHT."**

l. Company executes. The company commander then faces front and quietly commands the guide to **"Eyes, RIGHT."** The company commander presents sword, the guide presents guidon and both execute eyes right. Except for the commander, other officers and noncommissioned officers in the formation who are armed with swords remain at the order during eyes right.

(1) As the inspecting party moves across the member's front, each Marine turns their head and eyes to the left, following the inspecting party, until their head and eyes are to the front. Each Marine then stops the movement of their head and eyes and remains at attention.

(2) After the inspecting party has cleared the left flank of the company the company commander quietly gives the command of **"Order, ARMS"** to the guide.

(3) The company commander then executes carry sword, faces the company and commands **"Parade, REST."**

m. Company executes. Guide and company commander executes. The company commander remains facing the company.

(1) This process is repeated by each subsequent company commander.

(2) The inspecting party continues to move down the line of company commanders, saluting each company commander as they pass.

(3) The inspecting party salutes the colors as they pass in front of (but not behind) the colors.

(4) The color guard executes eyes right on the command of eyes right by the color company's company commander, however, only the organizational color bearer and left rifleman turn their head and eyes.

(5) After passing the left flank of the formation the inspecting party turns left and marches behind the formation. The last company commander does not give the command of parade rest until the inspecting party has passed behind his/her company.

n. As the inspecting party approaches the rear of each company the company commander commands **"Company, ATTENTION."**

o. The company executes. Once the inspecting party has cleared the companies rear the company commander commands **"Parade, REST."**

p. The company executes. The company commander then faces the reviewing area and goes to order sword and parade rest. This process is repeated by each subsequent company commander.

q. After the inspecting party completes passing around the rear of the formation the commander of troops moves to a position 3 paces in front of and 1 pace to the right of the band, draws sword and waits for the inspecting party to critique the inspection.

r. When the commander of troops is in position the reviewing officer and/or unit commander moves to a position 3 paces in front of and facing the commander of troops. The reviewing officer and/or unit commander and commander of troops exchange salutes.

s. The reviewing officer and/or unit commander then moves back to their position in the reviewing area. The commander of troops returns to a position in front of the staff.

t. The adjutant, seeing the commander of troops returning to position calls the staff to attention.

u. When the commander of troops arrives at the position in front of the staff, halts and faces the line of troops waits for the band to stop playing and commands **"Battalion, ATTENTION."**

v. Band stops playing.

w. The battalion executes. The commander and/or reviewing officer moves to their position in the reviewing area. The commander of troops then commands;

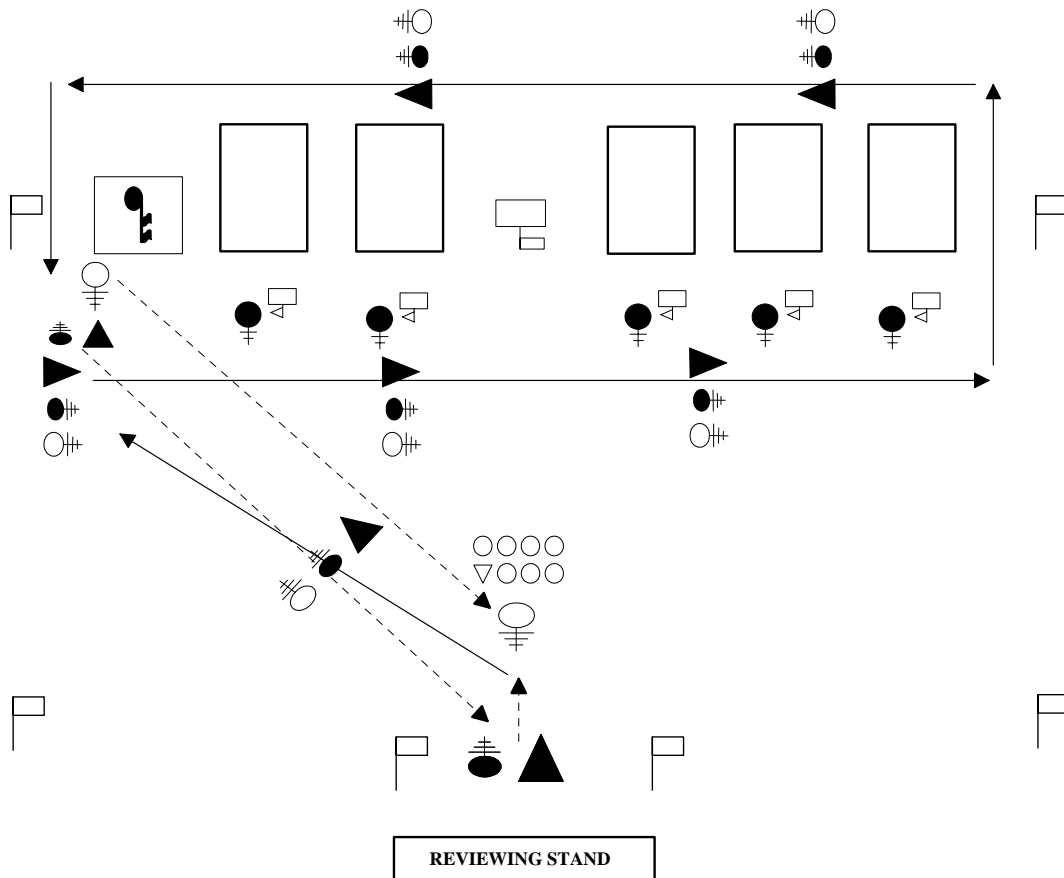

Figure 16-6.--Route of March for the Inspecting Party.

5. Note. At this time if:

a. The review is being held as an awards/retirement ceremony, go to chapter 18 and follow the sequence of events specified for the presentation of awards/retirement.

b. The review is being held for a change of command ceremony go to chapter 19 and follow the sequence of events specified for a change of command.

c. The review is being held for a relief and appointment of the sergeants major go to chapter 20 and follow the sequence of events specified for the relief and appointment of the sergeant major.

d. The review is being held for an activation or deactivation go to chapter 21 and follow the sequence of events specified for the activation or deactivation of a unit.

e. After completing one of the above sequences of events return to this Chapter and continue as follows.

6. March in Review

a. Unit commander/reviewing officer commands "MARCH THE COMMAND IN REVIEW."

b. The commander of troops faces the line of troops and commands "PASS IN REVIEW."

c. The unit marches in review as described in chapter 17, paragraphs 17007, 17008, 17009, and 17010. After the last element has marched in review, and the band and parade staff have cleared the field the narrator has announced the conclusion of the parade.

NARRATOR: "LADIES AND GENTLEMEN THIS CONCLUDES THIS EVENING'S REVIEW. ON BEHALF OF THE COMMANDING OFFICER (GENERAL) AND THE OFFICERS AND MARINES OF THE _____, THANK YOU FOR YOUR ATTENDANCE."