

Bus/Maint  
501

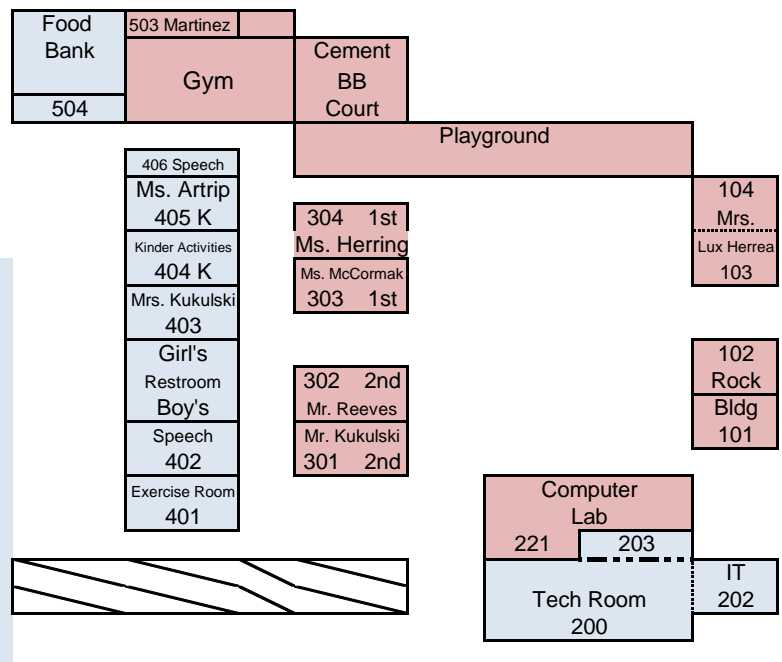

ZONE 3  
ZONE 3

ZONE 4  
ZONE 4

upper field

**During an emergency situation**  
Parents will need to report to the main office to show ID & proceed to the board room to retrieve their student.

To access staff extensions add a 1 in front of the 3 digit room number when dialing .

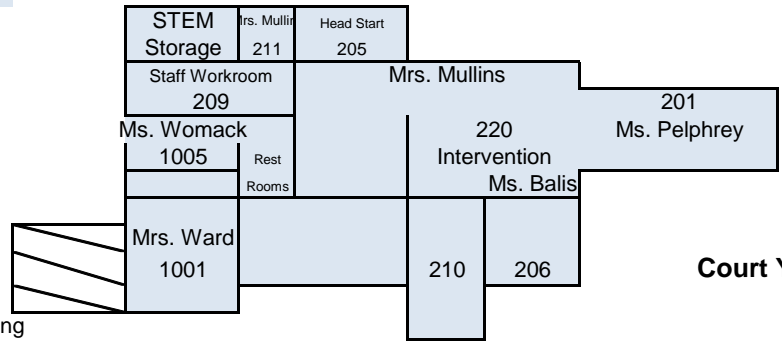
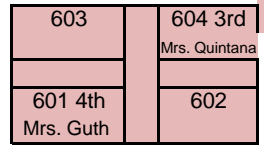

Court Yard

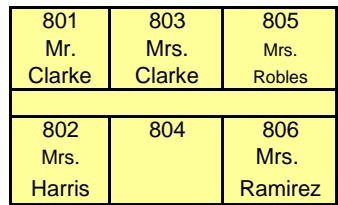
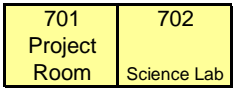

B & F  
u  
s  
L  
a  
n  
e  
N  
o  
P  
u  
b  
l  
i  
c  
T  
r  
a  
f  
f  
i  
c  
D  
u  
r  
i  
n  
g  
S  
c  
h  
o  
o  
l  
D  
a  
y  
s

Bus Loading Zone

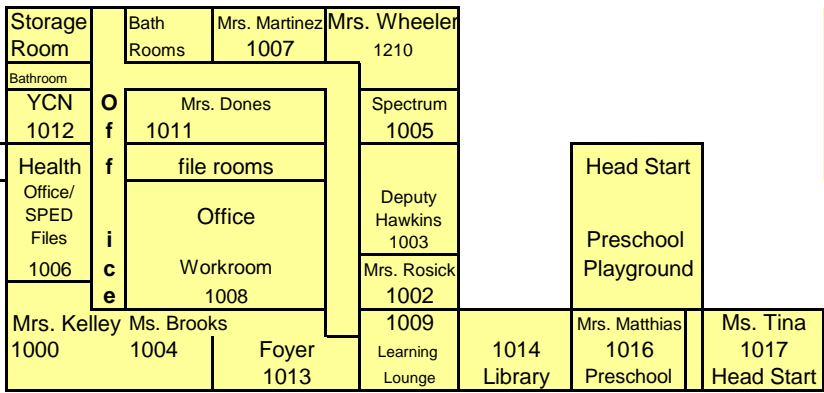
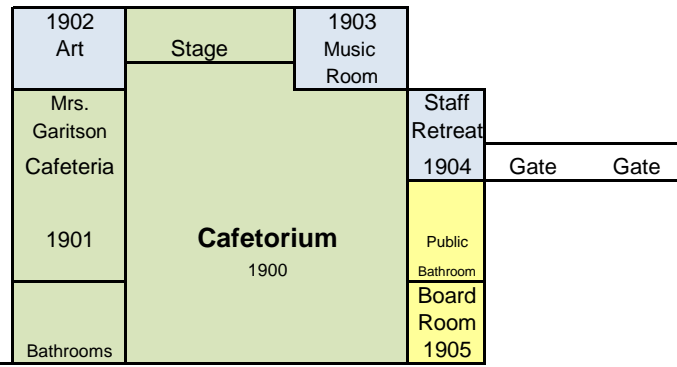

ZONE 1

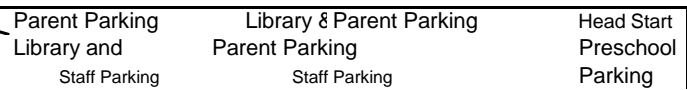
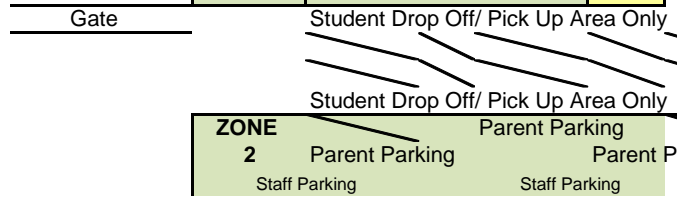
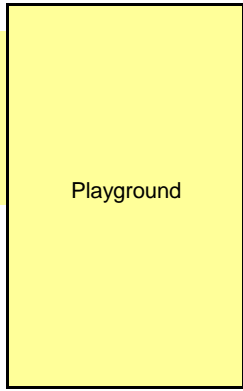

ZONE 1

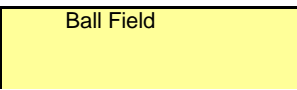

Gate no parking

